

DATE DOCUMENT CONTROL SECTION

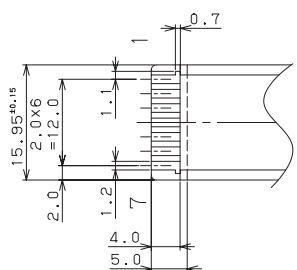

Conductive Face (導通面)

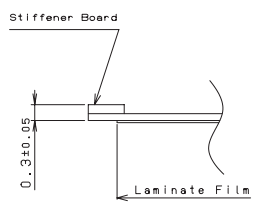

Contact Sectioning View
(コネクタ断面図)

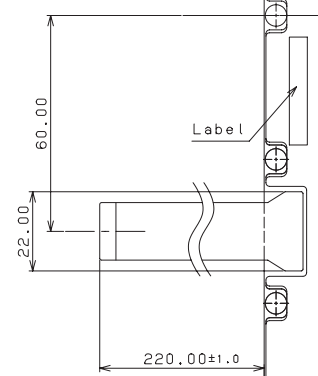

Label

Stiffener Board (補強板)

Conductive Face (導通面)
Gold plating (金メッキ)

Note
1.No Specified Tolerance is ±0.5.
・指定なき寸法公差は±0.5とする。

Part Number: N010-0510-T303

RoHS compliant

Thickness of Glass t=1.8 (ガラス板厚)

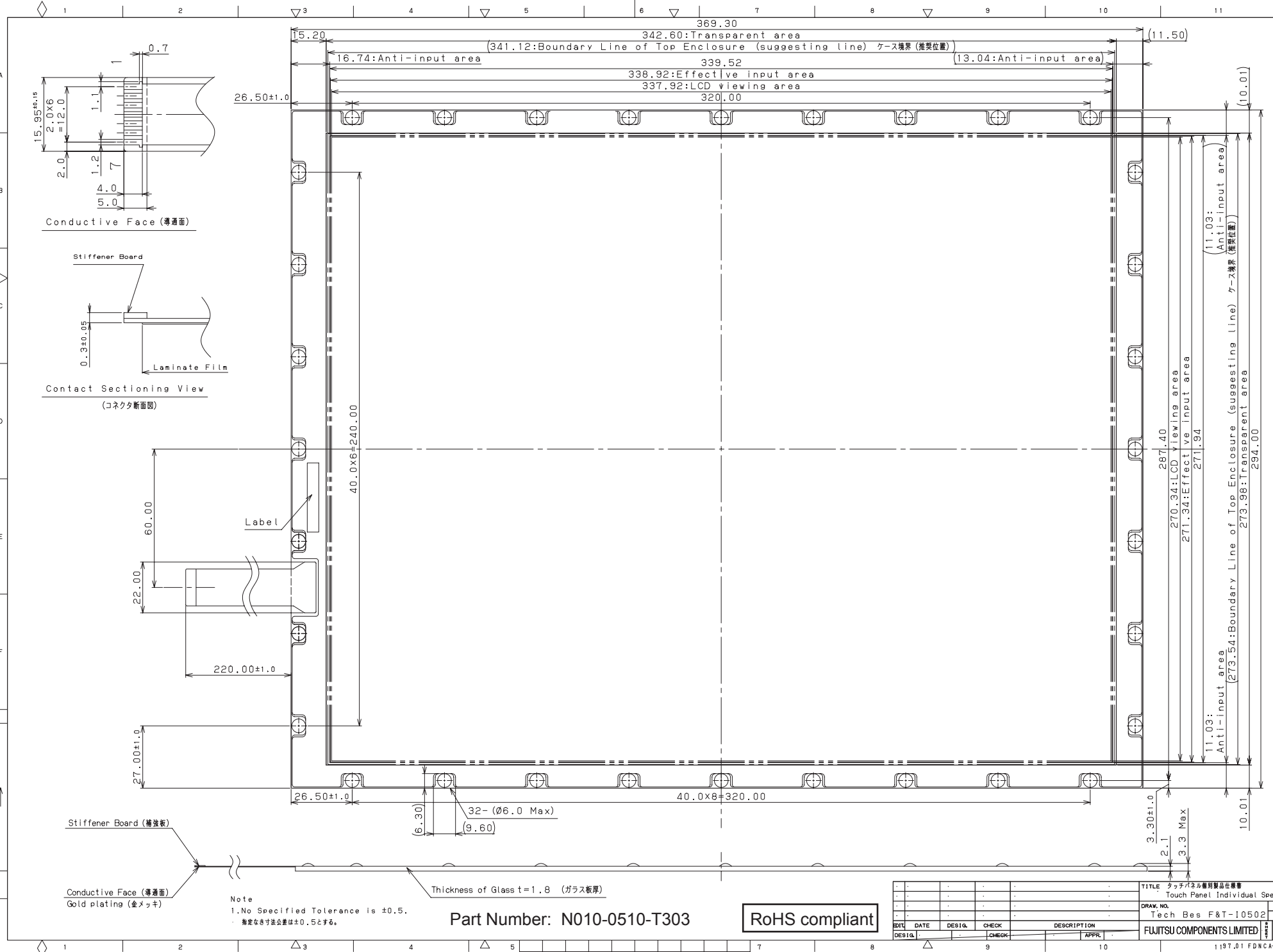

				TITLE タッチパネル個別製品仕様書 Touch Panel Individual Spec.	
				DRW. NO.	CUST.
				Tech Bes F&T-10502	
DESIG.	DATE	DESIG.	CHECK	DESCRIPTION	APPR.
				FUJITSU COMPONENTS LIMITED	5/5