

# Altivar Machine ATV320

Variable Speed Drives for Asynchronous and Synchronous Motors

## ATV312 to ATV320 Migration Manual

02/2017



---

The information provided in this documentation contains general descriptions and/or technical characteristics of the performance of the products contained herein. This documentation is not intended as a substitute for and is not to be used for determining suitability or reliability of these products for specific user applications. It is the duty of any such user or integrator to perform the appropriate and complete risk analysis, evaluation and testing of the products with respect to the relevant specific application or use thereof. Neither Schneider Electric nor any of its affiliates or subsidiaries shall be responsible or liable for misuse of the information contained herein. If you have any suggestions for improvements or amendments or have found errors in this publication, please notify us.

No part of this document may be reproduced in any form or by any means, electronic or mechanical, including photocopying, without express written permission of Schneider Electric.

All pertinent state, regional, and local safety regulations must be observed when installing and using this product. For reasons of safety and to help ensure compliance with documented system data, only the manufacturer should perform repairs to components.

When devices are used for applications with technical safety requirements, the relevant instructions must be followed.

Failure to use Schneider Electric software or approved software with our hardware products may result in injury, harm, or improper operating results.

Failure to observe this information can result in injury or equipment damage.

© 2017 Schneider Electric. All Rights Reserved.

---

# Table of Contents

---



	<b>Safety Information</b> .....	<b>5</b>
	<b>About the Book</b> .....	<b>9</b>
<b>Chapter 1</b>	<b>Introduction to Device Conversion Function</b> .....	<b>13</b>
	Device Conversion .....	<b>13</b>
<b>Chapter 2</b>	<b>Control Block Terminals</b> .....	<b>15</b>
	Control Terminals .....	<b>16</b>
	Digital Inputs .....	<b>18</b>
	Digital Outputs .....	<b>19</b>
	Analog Inputs .....	<b>20</b>
	Analog Outputs .....	<b>20</b>
	Power Supplies .....	<b>21</b>
	Relays .....	<b>21</b>
<b>Chapter 3</b>	<b>Functions Compatibilities</b> .....	<b>23</b>
	Applicative Functions .....	<b>24</b>
	Reverse .....	<b>26</b>
	Reverse Inhibition .....	<b>26</b>
	Speed Loop Parameters .....	<b>26</b>
	Macro-Configurations .....	<b>27</b>
	I/O Multi-Assignments .....	<b>27</b>
	2/3 Wires Control .....	<b>27</b>
	Freewheel Stop .....	<b>28</b>
	Fast Stop .....	<b>28</b>
	Ramp Types .....	<b>28</b>
	Ramp Switching .....	<b>29</b>
	Ramp Auto-Adaptation .....	<b>29</b>
	DC Injection Braking .....	<b>29</b>
	Reference Switching .....	<b>30</b>
	Separate Mode (Command & Reference) .....	<b>30</b>
	Reference Operation .....	<b>30</b>
	Jog .....	<b>31</b>
	Preset Speeds .....	<b>31</b>
	Brake Control Sequence .....	<b>31</b>
	+/- Speed .....	<b>31</b>
	2 <sup>nd</sup> Current Limitation .....	<b>32</b>
	Jump Frequency .....	<b>32</b>
	PID Regulator .....	<b>32</b>
	Internal PID reference .....	<b>32</b>
	Preset PID Reference .....	<b>33</b>
	Sleep / Wake-Up .....	<b>33</b>
	Catch On the Fly .....	<b>33</b>
	Automatic Restart .....	<b>33</b>
	Multi-Motors / Multi-Configurations .....	<b>34</b>

---



## Important Information

### NOTICE

Read these instructions carefully, and look at the equipment to become familiar with the device before trying to install, operate, service, or maintain it. The following special messages may appear throughout this documentation or on the equipment to warn of potential hazards or to call attention to information that clarifies or simplifies a procedure.



The addition of this symbol to a “Danger” or “Warning” safety label indicates that an electrical hazard exists which will result in personal injury if the instructions are not followed.



This is the safety alert symbol. It is used to alert you to potential personal injury hazards. Obey all safety messages that follow this symbol to avoid possible injury or death.

### **DANGER**

**DANGER** indicates a hazardous situation which, if not avoided, **will result in** death or serious injury.

### **WARNING**

**WARNING** indicates a hazardous situation which, if not avoided, **could result in** death or serious injury.

### **CAUTION**

**CAUTION** indicates a hazardous situation which, if not avoided, **could result in** minor or moderate injury.

### **NOTICE**

**NOTICE** is used to address practices not related to physical injury.

### PLEASE NOTE

Electrical equipment should be installed, operated, serviced, and maintained only by qualified personnel. No responsibility is assumed by Schneider Electric for any consequences arising out of the use of this material.

A qualified person is one who has skills and knowledge related to the construction and operation of electrical equipment and its installation, and has received safety training to recognize and avoid the hazards involved.

### Qualification Of Personnel

Only appropriately trained persons who are familiar with and understand the contents of this manual and all other pertinent product documentation are authorized to work on and with this product. In addition, these persons must have received safety training to recognize and avoid hazards involved. These persons must have sufficient technical training, knowledge and experience and be able to foresee and detect potential hazards that may be caused by using the product, by changing the settings and by the mechanical, electrical and electronic equipment of the entire system in which the product is used. All persons working on and with the product must be fully familiar with all applicable standards, directives, and accident prevention regulations when performing such work.

## Intended Use

This product is a drive for three-phase synchronous and asynchronous motors and intended for industrial use according to this manual. The product may only be used in compliance with all applicable safety regulations and directives, the specified requirements and the technical data. Prior to using the product, you must perform a risk assessment in view of the planned application. Based on the results, the appropriate safety measures must be implemented. Since the product is used as a component in an entire system, you must ensure the safety of persons by means of the design of this entire system (for example, machine design). Any use other than the use explicitly permitted is prohibited and can result in hazards. Electrical equipment should be installed, operated, serviced, and maintained only by qualified personnel.

## Product Related Information

Read and understand these instructions before performing any procedure with this drive.

### **DANGER**

#### **HAZARD OF ELECTRIC SHOCK, EXPLOSION OR ARC FLASH**

- Only appropriately trained persons who are familiar with and understand the contents of this manual and all other pertinent product documentation and who have received safety training to recognize and avoid hazards involved are authorized to work on and with this drive system. Installation, adjustment, repair and maintenance must be performed by qualified personnel.
- The system integrator is responsible for compliance with all local and national electrical code requirements as well as all other applicable regulations with respect to grounding of all equipment.
- Many components of the product, including the printed circuit boards, operate with mains voltage. Do not touch.
- Only use properly rated, electrically insulated tools and measuring equipment.
- Do not touch unshielded components or terminals with voltage present.
- Motors can generate voltage when the shaft is rotated. Prior to performing any type of work on the drive system, block the motor shaft to prevent rotation.
- AC voltage can couple voltage to unused conductors in the motor cable. Insulate both ends of unused conductors of the motor cable.
- Do not short across the DC bus terminals or the DC bus capacitors or the braking resistor terminals.
- Before performing work on the drive system:
  - Disconnect all power, including external control power that may be present.
  - Place a **Do Not Turn On** label on all power switches related to the drive system.
  - Lock all power switches in the open position.
  - Wait 15 minutes to allow the DC bus capacitors to discharge.
  - Follow the instructions given in the chapter "Verifying the Absence of Voltage" in the installation manual of the product.
- Before applying voltage to the drive system:
  - Verify that the work has been completed and that the entire installation cannot cause hazards.
  - If the mains input terminals and the motor output terminals have been grounded and short-circuited, remove the ground and the short circuits on the mains input terminals and the motor output terminals.
  - Verify proper grounding of all equipment.
  - Verify that all protective equipment such as covers, doors, grids is installed and/or closed.

**Failure to follow these instructions will result in death or serious injury.**

Drive systems may perform unexpected movements because of incorrect wiring, incorrect settings, incorrect data or other errors.

### **WARNING**

#### **UNANTICIPATED EQUIPMENT OPERATION**

- Carefully install the wiring in accordance with the EMC requirements.
- Do not operate the product with unknown or unsuitable settings or data.
- Perform a comprehensive commissioning test.

**Failure to follow these instructions can result in death, serious injury, or equipment damage.**

Damaged products or accessories may cause electric shock or unanticipated equipment operation.

## DANGER

### ELECTRIC SHOCK OR UNANTICIPATED EQUIPMENT OPERATION

Do not use damaged products or accessories.

**Failure to follow these instructions will result in death or serious injury.**

Contact your local Schneider Electric sales office if you detect any damage whatsoever.

## WARNING

### LOSS OF CONTROL

- The designer of any control scheme must consider the potential failure modes of control paths and, for critical control functions, provide a means to achieve a safe state during and after a path failure. Examples of critical control functions are emergency stop, overtravel stop, power outage and restart.
- Separate or redundant control paths must be provided for critical control functions.
- System control paths may include communication links. Consideration must be given to the implications of unanticipated transmission delays or failures of the link.
- Observe all accident prevention regulations and local safety guidelines (1).
- Each implementation of the product must be individually and thoroughly tested for proper operation before being placed into service.

**Failure to follow these instructions can result in death, serious injury, or equipment damage.**

(1) For USA: Additional information, refer to NEMA ICS 1.1 (latest edition), Safety Guidelines for the Application, Installation, and Maintenance of Solid State Control and to NEMA ICS 7.1 (latest edition), Safety Standards for Construction and Guide for Selection, Installation and Operation of Adjustable-Speed Drive Systems.

## NOTICE

### DESTRUCTION DUE TO INCORRECT MAINS VOLTAGE

Before switching on and configuring the product, verify that it is approved for the mains voltage

**Failure to follow these instructions can result in equipment damage.**

The temperature of the products described in this manual may exceed 80 °C (176 °F) during operation.

## WARNING

### HOT SURFACES

- Ensure that any contact with hot surfaces is avoided.
- Do not allow flammable or heat-sensitive parts in the immediate vicinity of hot surfaces.
- Verify that the product has sufficiently cooled down before handling it.
- Verify that the heat dissipation is sufficient by performing a test run under maximum load conditions.

**Failure to follow these instructions can result in death, serious injury, or equipment damage.**

This equipment has been designed to operate outside of any hazardous location. Only install this equipment in zones known to be free of a hazardous atmosphere.

## DANGER

### POTENTIAL FOR EXPLOSION

Install and use this equipment in non-hazardous locations only.

**Failure to follow these instructions will result in death or serious injury.**





---

# About the Book

---



## At a Glance

### Document Scope

The document provides the information about migration from ATV312 to ATV320.

### Validity Note

This documentation is valid for ATV320 devices which support device conversion.

The technical characteristics of the devices described in this document also appear online. To access this information online:

Step	Action
1	Go to the Schneider Electric home page <a href="http://www.schneider-electric.com">www.schneider-electric.com</a> .
2	In the <b>Search</b> box type the reference of a product or the name of a product range. <ul style="list-style-type: none"><li>• Do not include blank spaces in the reference or product range.</li><li>• To get information on grouping similar modules, use asterisks (*).</li></ul>
3	If you entered a reference, go to the <b>Product Datasheets</b> search results and click on the reference that interests you. If you entered the name of a product range, go to the <b>Product Ranges</b> search results and click on the product range that interests you.
4	If more than one reference appears in the <b>Products</b> search results, click on the reference that interests you.
5	Depending on the size of your screen, you may need to scroll down to see the data sheet.
6	To save or print a data sheet as a .pdf file, click <b>Download XXX product datasheet</b> .

The characteristics that are presented in this manual should be the same as those characteristics that appear online. In line with our policy of constant improvement, we may revise content over time to improve clarity and accuracy. If you see a difference between the manual and online information, use the online information as your reference.

## Related Documents

Use your tablet or your PC to quickly access detailed and comprehensive information on all our products on [www.schneider-electric.com](http://www.schneider-electric.com)

The Internet site provides the information you need for products and solutions

- The whole catalog for detailed characteristics and selection guides
- The CAD files to help design your installation, available in over 20 different file formats
- All software and firmware to maintain your installation up to date
- A large quantity of White Papers, Environment documents, Application solutions, Specifications... to gain a better understanding of our electrical systems and equipment or automation
- And finally all the User Guides related to your drive, listed below:

Title of Documentation	Reference Number
ATV320 Getting Started	<a href="#">NVE21763</a> (English), <a href="#">NVE21771</a> (French), <a href="#">NVE21772</a> (German), <a href="#">NVE21773</a> (Spanish), <a href="#">NVE21774</a> (Italian), <a href="#">NVE21776</a> (Chinese)
ATV320 Getting Started Annex (SCCR)	<a href="#">NVE21777</a> (English)
ATV320 Installation manual	<a href="#">NVE41289</a> (English), <a href="#">NVE41290</a> (French), <a href="#">NVE41291</a> (German), <a href="#">NVE41292</a> (Spanish), <a href="#">NVE41293</a> (Italian), <a href="#">NVE41294</a> (Chinese)
ATV320 Programming manual	<a href="#">NVE41295</a> (English), <a href="#">NVE41296</a> (French), <a href="#">NVE41297</a> (German), <a href="#">NVE41298</a> (Spanish), <a href="#">NVE41299</a> (Italian), <a href="#">NVE41300</a> (Chinese)
ATV320 Modbus Serial Link manual (embedded)	<a href="#">NVE41308</a> (English)
ATV320 Modbus TCP - Ethernet IP manual (VW3A3616)	<a href="#">NVE41313</a> (English)
ATV320 PROFIBUS DP manual (VW3A3607)	<a href="#">NVE41310</a> (English)
ATV320 DeviceNet manual (VW3A3609)	<a href="#">NVE41314</a> (English)
ATV320 CANopen manual (VW3A3608, 618, 628)	<a href="#">NVE41309</a> (English)
ATV320 POWERLINK manual (VW3A3619)	<a href="#">NVE41312</a> (English)
ATV320 EtherCAT manual (VW3A3601)	<a href="#">NVE41315</a> (English)
ATV320 Communication Parameters	<a href="#">NVE41316</a> (English)
ATV320 Safety Functions manual	<a href="#">NVE50467</a> (English), <a href="#">NVE50468</a> (French), <a href="#">NVE50469</a> (German), <a href="#">NVE50470</a> (Spanish), <a href="#">NVE50472</a> (Italian), <a href="#">NVE50473</a> (Chinese)
BMP Synchronous Motor manual	<a href="#">0198441113981-EN</a> (English), <a href="#">0198441113982-FR</a> (French), <a href="#">0198441113980-DE</a> (German), <a href="#">0198441113984-ES</a> (Spanish), <a href="#">0198441113983-IT</a> (Italian), <a href="#">0198441113985-ZH</a> (Chinese)
ATV320 ATV Logic manual	<a href="#">NVE71954</a> (English), <a href="#">NVE71955</a> (French), <a href="#">NVE71957</a> (German), <a href="#">NVE71959</a> (Spanish), <a href="#">NVE71958</a> (Italian), <a href="#">NVE71960</a> (Chinese)
SoMove: FDT	<a href="#">SoMove FDT</a> (English, French, German, Spanish, Italian, Chinese)
ATV320: DTM	<a href="#">ATV320 DTM Library</a> (English, French, German, Spanish, Italian, Chinese)
ATV312 to ATV320 Migration manual	<a href="#">QGH39563</a> (English)

You can download these technical publications and other technical information from our website at <http://www.schneider-electric.com/ww/en/download>

---

## Terminology

The technical terms, terminology, and the corresponding descriptions in this manual normally use the terms or definitions in the relevant standards.

In the area of drive systems this includes, but is not limited to, terms such as **error, error message, failure, fault, fault reset, protection, safe state, safety function, warning, warning message**, and so on.

Among others, these standards include:

- IEC 61800 series: Adjustable speed electrical power drive systems
- IEC 61508 Ed.2 series: Functional safety of electrical/electronic/programmable electronic safety-related
- EN 954-1 Safety of machinery - Safety related parts of control systems
- EN ISO 13849-1 & 2 Safety of machinery - Safety related parts of control systems.
- IEC 61158 series: Industrial communication networks - Fieldbus specifications
- IEC 61784 series: Industrial communication networks - Profiles
- IEC 60204-1: Safety of machinery - Electrical equipment of machines – Part 1: General requirements

In addition, the term **zone of operation** is used in conjunction with the description of specific hazards, and is defined as it is for a **hazard zone** or **danger zone** in the EC Machinery Directive (2006/42/EC) and in ISO 12100-1.



---

# Chapter 1

## Introduction to Device Conversion Function

---

### Device Conversion

#### Overview

Device conversion allows you to convert the configuration (.psx file) of one device (source device) to another device (target device).

**For example:** The ATV312 configuration can be used as ATV320 configuration after the device conversion operation.

**NOTE:** The device conversion function is available only in the SoMove FDT container.

The table provides the list of devices which support device conversion

From Source Device	To Target Device
ATV32	ATV320
ATV312	ATV320

### WARNING

#### UNANTICIPATED EQUIPMENT OPERATION

Device conversion function is used to apply the configuration from a drive product range to another drive product range. However, the values of certain parameters cannot be applied because the functional behaviors of the source drive and the target drive are different.

The parameters whose values cannot be applied are kept to the factory settings.

- Consult the programming manual for the parameters that are kept to their factory settings and select appropriate values for these parameters.
- Do not operate the product with unknown or unsuitable settings or data.
- Perform a comprehensive commissioning test.



**Failure to follow these instructions can result in death, serious injury, or equipment damage.**

#### Pre-Condition

Install SoMove FDT on your PC.

**Conversion of Device Configuration**

The table provides the procedure to convert the device configuration

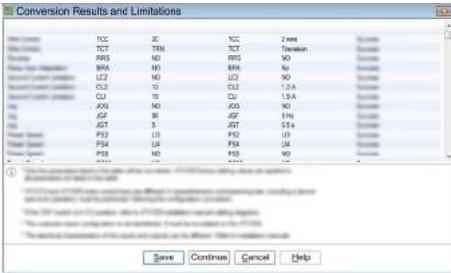
Step	Action	Comments
1	<p>On the SoMove start page, do one of the following</p> <ul style="list-style-type: none"> <li>Click the <b>Device Conversion</b> button</li> <li>Press <b>CTRL + ALT + Q</b> keys, on the menu bar, click <b>File → Device Conversion</b></li> </ul> <p><b>Result:</b> Opens <b>Device Conversion</b> dialog box</p>	
2	 <p>In the <b>Device Conversion</b> dialog box</p> <ol style="list-style-type: none"> <li>Click the  button in the <b>Source</b> zone <b>Result:</b> Opens the <b>Select device configuration</b> dialog box</li> <li>In the <b>Select device configuration</b> dialog box, select the configuration file (.psx) you wish to convert and then click <b>Open</b></li> <li>Select the target device in <b>Select Target DTM</b> box</li> <li>Click <b>Convert</b></li> </ol> <p><b>Result:</b> Opens <b>Select Target Device Reference</b> dialog box</p>	<p><b>NOTE:</b></p> <ul style="list-style-type: none"> <li>The <b>Source</b> zone displays the path and the device type of selected configuration.</li> <li>The <b>Target</b> zone allows you to select the device to which the selected configuration file is converted</li> </ul>
3	<p>In the <b>Select Target Device Reference</b> dialog box, select the target device reference in the <b>Reference</b> box and click <b>OK</b></p> <p><b>Result:</b> Opens the <b>Conversion Result and Limitations</b> dialog box</p>	
4	 <p>In the <b>Conversion Results and Limitations</b> dialog box, click <b>Continue</b>.</p> <p><b>Result:</b> Displays the <b>UNANTICIPATED EQUIPMENT OPERATION</b> message</p>	<p>The <b>Conversion Results and Limitation</b> dialog box, displays the result and limitations of device conversion operation. It consists of six columns</p> <ul style="list-style-type: none"> <li><b>Function name:</b> Displays the name of the function</li> <li><b>Source Param:</b> Displays the parameter related to the source device</li> <li><b>Source Param Value:</b> Displays the values of the parameters related to source device before conversion.</li> <li><b>Target Param:</b> Displays the parameters related to the target device.</li> <li><b>Target Param Value:</b> Displays the value of the parameters related to the target device after conversion.</li> <li><b>Remark:</b> Displays the remark related to the conversion of the individual parameters.</li> </ul> <p><b>NOTE:</b></p> <ul style="list-style-type: none"> <li>To save the conversion results and limitations (.txt format), click the <b>Save</b> button.</li> <li>To stop the device conversion operation, click the <b>Cancel</b> button</li> <li>To open the device conversion manual, click the <b>Help</b> button.</li> </ul>
5	<p>Read the message carefully and then click <b>OK</b></p> <p><b>Result:</b> Opens the target device DTM with the converted configuration</p>	

---

# Chapter 2

## Control Block Terminals

---

### What Is in This Chapter?

This chapter contains the following topics:

Topic	Page
Control Terminals	16
Digital Inputs	18
Digital Outputs	19
Analog Inputs	20
Analog Outputs	20
Power Supplies	21
Relays	21

## Control Terminals

### Introduction

ATV320 offers similar control terminals as ATV312.  
 Below is the presentation of terminals of each product.

### ATV312 Control Terminal

The following figures shows the AT312 control terminals

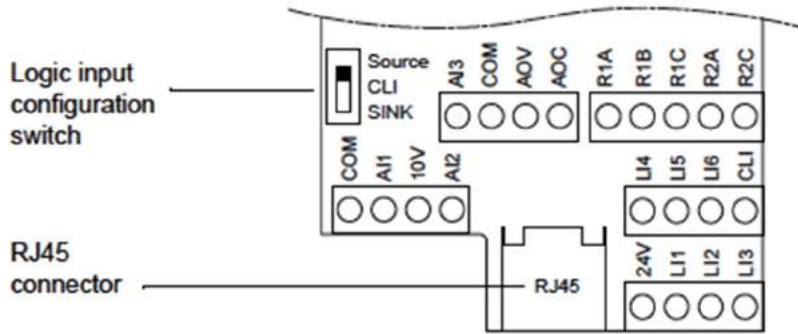

### ATV320 Control Terminal

The following figure shows the ATV320 book and compact control terminals:

ATV320●●●●●B

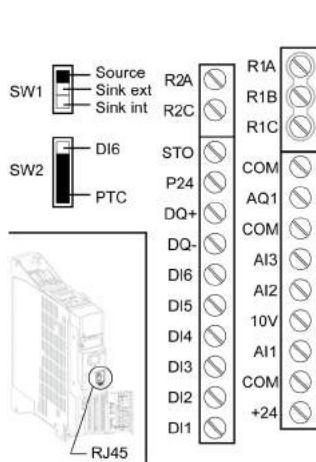

ATV320●●●●●C

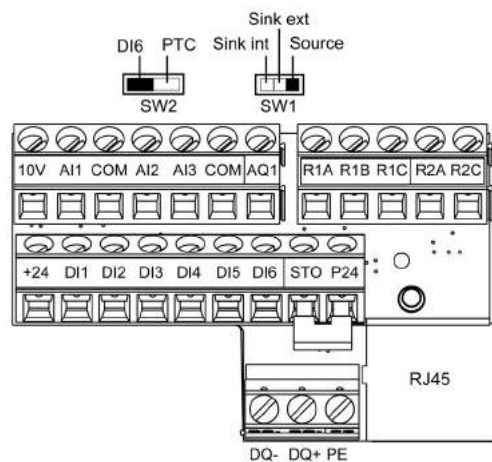



### ATV312 and ATV320 Inputs/Outputs Description

The table provides the list of inputs and outputs available on ATV312 and ATV320 drives

ATV312	ATV320	Description
LI1	DI1	Digital inputs
LI2	DI2	
LI3	DI3	
LI4	DI4	
LI5	DI5	
LI6	DI6	
CLI	–	Logic input common
SW	SW1	Digital input switch
AOC <sup>(1)</sup>	DQ+, DQ-	Digital output
AI1	AI1	Analog input 1
AI2	AI2	Analog input 2
AI3	AI3	Analog input 3
AOV	AQ1	Analog output voltage
AOC	–	Analog output current
10 V	10 V	Internal supply for the analog inputs
24 V	+24	+24 Vdc input supply
R1A	R1A	Common point C/O contact (R1C) of programmable relay R1
R1B	R1B	
R1C	R1C	
R2A	R2A	NO contact of relay R2
R2C	R2C	
–	STO	STO input
–	P24	Output power supply for digital inputs and safety function STO inputs.
<sup>(1)</sup> Can be programmed as digital output.		

## Digital Inputs

### Characteristics

The table provides the characteristics of digital inputs of ATV312 and ATV320 devices

Digital Inputs		Characteristics	
ATV312	ATV320	ATV312	ATV320
LI1	DI1	Programmable logic inputs <ul style="list-style-type: none"> <li>+ 24 V power supply (max. 30 V)</li> <li>Impedance 3.5 kΩ</li> <li>State 0 if &lt; 5 V, state 1 if &gt; 11 V (voltage difference between LI- and CLI)</li> <li>Sampling time 4 ms</li> </ul>	Programmable digital inputs configurable as sink or source using SW1 switch <ul style="list-style-type: none"> <li>+ 24 Vdc power supply (max. 30 Vdc)</li> <li>State 0 if &lt; 5 V, state 1 if &gt; 11 V (in source mode)</li> <li>State 0 if &gt; 19 V, state 1 if &lt; 13 V (in sink mode)</li> <li>Response time 8 ms at stop</li> </ul>
LI2	DI2		
LI3	DI3		
LI4	DI4		
LI5	DI5		
LI6	DI6		

### Configuration

On both ATV312 and ATV320, a switch is available to configure the digital inputs. With this switch it is possible to configure the inputs on:

- Source mode, or
- Sink Int mode, or
- Sink Ext mode

The following figure shows the ATV312 SW switch

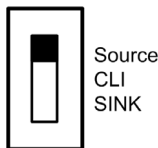

**NOTE:** CLI position corresponds to **Sink ext** mode and **SINK** corresponds to **Sink int** on ATV320.

The following figure shows the ATV320 Book SW1 switch

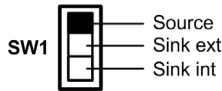

The following figure shows the ATV320 Compact SW1 switch

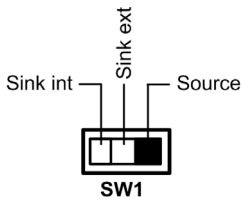

For more information about wiring of digital inputs according to the mode selected, refer to the ATV320 Installation Manual ([NVE41289](#)).

## Digital Outputs

### Characteristics

The table provides the characteristics of digital outputs of ATV312 and ATV320 devices

Digital Outputs		Characteristics	
ATV312	ATV320	ATV312	ATV320
AOC	DQ+, DQ-	Can be configured as 24 Vdc logic output on AOC, min. load impedance 1.2 k $\Omega$	Open collector output configurable as sink or source using SW1 switch. <ul style="list-style-type: none"> <li>● Refresh time: 2 ms</li> <li>● Maximum voltage: 30 Vdc</li> <li>● Maximum current: 100 mA</li> </ul>

For more information about wiring of digital output, refer to the ATV320 Installation Manual ([NVE41289](#)).

## Analog Inputs

### Characteristics

The table provides the characteristics of analog inputs of ATV312 and ATV320 devices

Analog Inputs		Characteristics	
ATV312	ATV320	ATV312	ATV320
AI1	AI1	Analog input 0 + 10 Vdc <ul style="list-style-type: none"> <li>● Impedance 30 k<math>\Omega</math></li> <li>● Resolution: 10-bit converter</li> <li>● Precision <math>\pm 4.3\%</math>, linearity <math>\pm 0.2\%</math>, of max. value</li> <li>● Sampling time 8 ms</li> </ul>	Analog input 0 + 10 Vdc <ul style="list-style-type: none"> <li>● Impedance 30 k<math>\Omega</math></li> <li>● Resolution: 10-bit converter</li> <li>● Accuracy <math>\pm 0.5\%</math>, Linearity <math>\pm 0.2\%</math> of max. value</li> <li>● Sampling time 2 ms</li> </ul>
AI2	AI2	Bipolar analog input 0 $\pm$ 10 Vdc The + or - polarity of the voltage on AI2 affects the direction of the setpoint and therefore the direction of operation. <ul style="list-style-type: none"> <li>● Impedance 30 k<math>\Omega</math></li> <li>● Resolution: 10-bits</li> <li>● Precision <math>\pm 4.3\%</math>, linearity <math>\pm 0.2\%</math>, of max. value</li> <li>● Sampling time 8 ms</li> </ul>	Bipolar analog input 0 $\pm$ 10 Vdc The + or - polarity of the voltage on AI2 affects the direction of the setpoint and therefore the direction of operation. <ul style="list-style-type: none"> <li>● Impedance 30 k<math>\Omega</math></li> <li>● Resolution: 10-bits</li> <li>● Accuracy <math>\pm 0.5\%</math>, Linearity <math>\pm 0.2\%</math> of max. value</li> <li>● Sampling time 2 ms</li> </ul>
AI3	AI3	Analog input X - Y mA. X and Y can be programmed 0...20 mA <ul style="list-style-type: none"> <li>● Impedance 250 <math>\Omega</math></li> <li>● Resolution: 0.02 mA, 10-bit converter</li> <li>● Precision <math>\pm 4.3\%</math>, linearity <math>\pm 0.2\%</math>, of max. value</li> <li>● Sampling time 8 ms</li> </ul>	Analog input X - Y mA. X and Y can be programmed from 0 to 20 mA <ul style="list-style-type: none"> <li>● Impedance 250 <math>\Omega</math></li> <li>● Resolution: 10 bits</li> <li>● Accuracy <math>\pm 0.5\%</math>, linearity <math>\pm 0.2\%</math>, of max. value</li> <li>● Sampling time 2 ms</li> </ul>

## Analog Outputs

### Characteristics

The table provides the characteristics of analog outputs of ATV312 and ATV320 devices

Analog Outputs		Characteristics	
ATV312	ATV320	ATV312	ATV320
AOV or AOC	AQ1	<ul style="list-style-type: none"> <li>● AOV: Analog output 0 to 10 Vdc, min. load impedance 470 <math>\Omega</math> or</li> <li>● AOC: Analog output X - Y mA. X and Y can be programmed 0...20 mA, max. load impedance 800 <math>\Omega</math></li> <li>● Resolution 8 bits</li> <li>● Precision <math>\pm 1\%</math></li> <li>● Linearity <math>\pm 0.2\%</math></li> <li>● Sampling time 8 ms</li> </ul>	Analog output software-configurable for voltage or current <ul style="list-style-type: none"> <li>● Voltage analog output 0...10 Vdc, minimum. Minimum load impedance 470 <math>\Omega</math>,</li> <li>● Current analog output X-Y mA by programming X and Y from 0...20 mA, maximum load impedance 820 <math>\Omega</math></li> <li>● Resolution 10 bits</li> <li>● Accuracy: <math>\pm 1\%</math> for a temperature variation of 60 <math>^{\circ}\text{C}</math> (140<math>^{\circ}\text{F}</math>)</li> <li>● Linearity <math>\pm 0.2\%</math></li> <li>● Maximum sampling time: 5 <math>\pm</math> 1 ms</li> </ul>

## Power Supplies

### Characteristics

The table provides the characteristics of power supplies of ATV312 and ATV320 devices

Power supplies		Characteristics	
ATV312	ATV320	ATV312	ATV320
10 V	10 V	+10 Vdc (+8 - 0%), 10 mA max, protected against short-circuits and overloads	Internal supply for the analog inputs <ul style="list-style-type: none"> <li>● Tolerance <math>\pm 10\%</math></li> <li>● Current: maximum 10 mA</li> </ul>
24 V	+24 V	+ 24 Vdc protected against short-circuits and overloads, min. 19 Vdc, max. 30 Vdc Max. customer current available 100 mA	+24 Vdc input supply <ul style="list-style-type: none"> <li>● Tolerance: -15...+20%</li> <li>● Current: 100 mA</li> </ul>

## Relays

### Characteristics

The table provides the characteristics of relays of ATV312 and ATV320 devices

Relays		Characteristics	
ATV312	ATV320	ATV312	ATV320
R1A R1B R1C	R1A R1B R1C	<ul style="list-style-type: none"> <li>● Min. switching capacity: 10 mA for 5 Vdc</li> <li>● Max. switching capacity on resistive load (<math>\cos \phi = 1</math> and <math>L/R = 0</math> ms): 5 A for 250 Vac and 30 Vdc</li> <li>● Max. switching capacity on inductive load (<math>\cos \phi = 0.4</math> and <math>L/R = 7</math> ms): 1.5 A for 250 Vac and 30 Vdc</li> <li>● Sampling time: 8 ms</li> <li>● 100,000 operations at max. switching power</li> <li>● 1,000,000 operations at min. switching power</li> </ul>	<ul style="list-style-type: none"> <li>● Min. switching capacity: 5 mA for 24 Vdc</li> <li>● Max. switching current on resistive load (<math>\cos \phi = 1</math>): 3 A for 250 Vac (OVC II) and 30 Vdc</li> <li>● Maximum switching current on inductive load: (<math>\cos \phi = 0.4</math> and <math>L/R = 7</math> ms): 2 A for 250 Vac (OVC II) and 30 Vdc</li> <li>● Refresh time: 2 ms</li> <li>● 100,000 operations at maximum switching current</li> </ul>
R2A R2C	R2A R2C	<ul style="list-style-type: none"> <li>● Min. switching capacity: 10 mA for 5 Vdc</li> <li>● Max. switching capacity on resistive load (<math>\cos \phi = 1</math> and <math>L/R = 0</math> ms): 5 A for 250 Vac and 30 Vdc</li> <li>● Max. switching capacity on inductive load (<math>\cos \phi = 0.4</math> and <math>L/R = 7</math> ms): 1.5 A for 250 Vac and 30 Vdc</li> <li>● Sampling time: 8 ms</li> <li>● 100,000 operations at max. switching power</li> <li>● 1,000,000 operations at min. switching power</li> </ul>	<ul style="list-style-type: none"> <li>● Min. switching capacity: 5 mA for 24 Vdc</li> <li>● Max. switching current on resistive load (<math>\cos \phi = 1</math>): 5 A for 250 Vac and 30 Vdc</li> <li>● Maximum switching current on inductive load: (<math>\cos \phi = 0.4</math> and <math>L/R = 7</math> ms): 2 A for 250 Vac and 30 Vdc</li> <li>● Refresh time: 2 ms</li> <li>● 100,000 operations at maximum switching power</li> <li>● 100,000 operations at minimum switching power</li> </ul>



---

# Chapter 3

## Functions Compatibilities

---

### What Is in This Chapter?

This chapter contains the following topics:

Topic	Page
Applicative Functions	24
Reverse	26
Reverse Inhibition	26
Speed Loop Parameters	26
Macro-Configurations	27
I/O Multi-Assignments	27
2/3 Wires Control	27
Freewheel Stop	28
Fast Stop	28
Ramp Types	28
Ramp Switching	29
Ramp Auto-Adaptation	29
DC Injection Braking	29
Reference Switching	30
Separate Mode (Command & Reference)	30
Reference Operation	30
Jog	31
Preset Speeds	31
Brake Control Sequence	31
+/- Speed	31
2 <sup>nd</sup> Current Limitation	32
Jump Frequency	32
PID Regulator	32
Internal PID reference	32
Preset PID Reference	33
Sleep / Wake-Up	33
Catch On the Fly	33
Automatic Restart	33
Multi-Motors / Multi-Configurations	34

## Applicative Functions

### Introduction

ATV320 offers similar applicative functions compare to ATV312.

ATV320 offers also additional functions like functional safety, ATV Logic, and so on

For more information about the ATV320 functions, refer to the ATV320 Programming Manual ([NVE41295](#)).

### WARNING

#### UNANTICIPATED EQUIPMENT OPERATION

Device conversion function is used to apply the configuration from a drive product range to another drive product range. However, the values of certain parameters cannot be applied because the functional behaviors of the source drive and the target drive are different.

The parameters whose values cannot be applied are kept to the factory settings.

- Consult the programming manual for the parameters that are kept to their factory settings and select appropriate values for these parameters.
- Do not operate the product with unknown or unsuitable settings or data.
- Perform a comprehensive commissioning test.

**Failure to follow these instructions can result in death, serious injury, or equipment damage.**

### List of Functions

**NOTE:** Some functions available on both products can have minor differences and cannot be converted; this will be detailed on next pages.

The table provides the summary of the functions available in ATV312 and ATV320

Function	ATV312	ATV320	Conversion
Reverse	✓	✓	Yes
Reverse Inhibition	✓	✓	No
Speed Loop Parameters	✓	✓	No
Macro-configurations	✓	✓	No
I/O multi-assignment	✓	✓	Yes
2/3 wires control	✓	✓	Yes
Freewheel stop	✓	✓	Yes
Fast stop	✓	✓	Yes
Ramp types	✓	✓	Yes
Ramp switching	✓	✓	Yes
Ramp auto-adaptation	✓	✓	Yes
DC injection braking	✓	✓	Yes
Reference switching	✓	✓	No
Separate mode (command & reference)	✓	✓	No
Reference operation	✓	✓	Yes
Jog	✓	✓	Yes
Preset Speeds	✓	✓	Yes
Brake control sequence	✓	✓	No
High-speed hoisting	–	✓	–
Rope slack	–	✓	–
External weight measurement	–	✓	–
+/- Speed	✓	✓	Yes
+/- Speed around reference	–	✓	–
2nd Current limitation	✓	✓	Yes
Torque limitation	–	✓	–
Master/slave	–	✓	–
Jump frequency	✓	✓	Yes



Function	ATV312	ATV320	Conversion
PID regulator	✓	✓	No
Internal PID reference	✓	✓	No
Preset PID reference	✓	✓	No
PID predictive speed	–	✓	–
Sleep / WakeUp	✓	✓	No
Catch on the fly	✓	✓	Yes
Automatic restart	✓	✓	Yes
Limit switches	✓	✓	No
Positioning	–	✓	–
Supply Mains contactor control	–	✓	–
Output contactor control	–	✓	–
Traverse control	–	✓	–
Parameter sets switching	–	✓	–
Multi-Motors, Multi-Configurations	✓	✓	No
Safety functions	–	✓	–
ATV Logic	–	✓	–

## Reverse

### Overview

This function is available in both ATV312 and ATV320 drives

In factory settings, the reverse function **[Reverse Assign]** `r r 5` is set to the **[DI2]** `L 1 2` on both products.

### Device Conversion

Conversion from an ATV312 configuration into ATV320 configuration is supported for this function.

## Reverse Inhibition

### Overview

This function is available in both ATV312 and ATV320 drives but the parameters are not the same

On ATV312, this function is set using the **[Rotating direction]** `r o t ?` parameter.

On ATV320, this function is set using the **[Reverse Disable]** `r i n ?` parameter.

### Device Conversion

Conversion from an ATV312 configuration into ATV320 configuration is not supported for this function.

For more information about Reverse Inhibition, refer to the ATV320 Programming Manual ([NVE41295](#)).

## Speed Loop Parameters

### Overview

This function is available in both ATV312 and ATV320 drives but the parameters are not the same

These parameters have an effect on the drives performances.

### Device Conversion

Conversion from an ATV312 configuration into ATV320 configuration is not supported for this function.

The parameters related to this function are set to factory setting values and needs to be adjusted depending on the application.

For more information about Speed Loop Parameters, refer to the ATV320 Programming Manual ([NVE41295](#)).

## Macro-Configurations

### Overview

This function is available in both ATV312 and ATV320 drives but macro-configuration lists are not the same.

On ATV312, there are 2 sets of macro configurations.

On ATV320, there are 6 sets of macro configurations.

### Device Conversion

Conversion from an ATV312 configuration into ATV320 configuration is not supported for this function.

The parameters related to this function are set to factory setting values and needs to be adjusted depending on the application.

For more information about macro-configuration, refer to the ATV320 Programming Manual ([NVE41295](#)).

## I/O Multi-Assignments

### Overview

This function is available in both ATV312 and ATV320 drives.

### Device Conversion

Conversion from an ATV312 configuration into ATV320 configuration is supported for this function with some limitation that is; if the digital output is used in combination with the brake sequence, conversion is not possible.

The parameters related to this function are set to factory setting values and needs to be adjusted depending on the application.

For more information about I/O Multi-Assignments, refer to the ATV320 Programming Manual ([NVE41295](#)).

## 2/3 Wires Control

### Overview

This function is available in both ATV312 and ATV320 drives.

### Device Conversion

Conversion from an ATV312 configuration into ATV320 configuration is supported for this function.

For more information about 2/3 Wires Control, refer to the ATV320 Programming Manual ([NVE41295](#)).

## Freewheel Stop

### Overview

This function is available in both ATV312 and ATV320 drives.

### Device Conversion

Conversion from an ATV312 configuration into ATV320 configuration is supported for this function. For more information about Freewheel Stop, refer to the ATV320 Programming Manual ([NVE41295](#)).

## Fast Stop

### Overview

This function is available in both ATV312 and ATV320 drives.

### Device Conversion

Conversion from an ATV312 configuration into ATV320 configuration is supported for this function. For more information about Fast Stop, refer to the ATV320 Programming Manual ([NVE41295](#)).

## Ramp Types

### Overview

This function is available in both ATV312 and ATV320 drives.

Depending of the value of the parameter **[Ramp Type] r P E**, the values of **[Acceleration] A C C**, **[Deceleration] d E C**, **[Acceleration 2] A C 2** and **[Deceleration 2] d E 2** are converted:

- If **[Ramp Type] r P E** is set to **[Linear] L i n**, the parameters are converted without modification.
- If **[Ramp Type] r P E** is set to **[S-Ramp] S**, the parameters are converted following this formula:  $ACC = ACC/1.4$ ,  $DEC = DEC/1.4$ ,  $AC2 = AC2/1.4$ ,  $DE2 = DE2/1.4$
- If **[Ramp Type] r P E** is set to **[U-Ramp] u**, the parameters are converted following this formula:  $ACC = ACC/1.5$ ,  $DEC = DEC/1.5$ ,  $AC2 = AC2/1.5$ ,  $DE2 = DE2/1.5$
- If **[Ramp Type] r P E** is set to **[Customized] C u S**, the parameter are converted following this formula:  $ACC = ACC*100 / (TA1+TA2+100)$ ,  $DEC = DEC*100 / (TA3+TA4+100)$ ,  $AC2 = AC2*100 / (TA1+TA2+100)$ ,  $DE2 = DE2*100 / (TA33+TA4+100)$

### Device Conversion

Conversion from an ATV312 configuration into ATV320 configuration is supported for this function. For more information about Ramp Types, refer to the ATV320 Programming Manual ([NVE41295](#)).

## Ramp Switching

### Overview

This function is available in both ATV312 and ATV320 drives.

### Device Conversion

Conversion from an ATV312 configuration into ATV320 configuration is supported for this function.

The parameters related to this function are set to factory setting values and needs to be adjusted depending on the application.

For more information about Ramp Switching, refer to the ATV320 Programming Manual ([NVE41295](#)).

## Ramp Auto-Adaptation

### Overview

This function is available in both ATV312 and ATV320 drives.

### Device Conversion

Conversion from an ATV312 configuration into ATV320 configuration is supported for this function.

For more information about Ramp Auto-Adaptation, refer to the ATV320 Programming Manual ([NVE41295](#)).

## DC Injection Braking

### Overview

This function is available in both ATV312 and ATV320 drives.

ATV320 offers additional parameters for this function.

### Device Conversion

Conversion from an ATV312 configuration into ATV320 configuration is supported for this function.

For more information about DC Injection Braking, refer to the ATV320 Programming Manual ([NVE41295](#)).

## Reference Switching

### Overview

This function is available in both ATV312 and ATV320 drives but configuration of this function is not the same.

### Device Conversion

Conversion from an ATV312 configuration into ATV320 configuration is not supported for this function. For more information about Reference Switching, refer to the ATV320 Programming Manual ([NVE41295](#)).

## Separate Mode (Command & Reference)

### Overview

This function is available in both ATV312 and ATV320 drives but configuration of this function is not the same.

### Device Conversion

Conversion from an ATV312 configuration into ATV320 configuration is not supported for this function. The parameters related to this function are set to factory setting values and needs to be adjusted depending on the application. For more information about Separate Mode (Command & Reference), refer to the ATV320 Programming Manual ([NVE41295](#)).

## Reference Operation

### Overview

This function is available in both ATV312 and ATV320 drives. ATV320 offers additional parameters for this function.

### Device Conversion

Conversion from an ATV312 configuration into ATV320 configuration is supported for this function. For more information about Reference Operation, refer to the ATV320 Programming Manual ([NVE41295](#)).

## Jog

### Overview

This function is available in both ATV312 and ATV320 drives.

### Device Conversion

Conversion from an ATV312 configuration into ATV320 configuration is supported for this function. For more information about Jog, refer to the ATV320 Programming Manual ([NVE41295](#)).

## Preset Speeds

### Overview

This function is available in both ATV312 and ATV320 drives.

### Device Conversion

Conversion from an ATV312 configuration into ATV320 configuration is supported for this function. For more information about Preset Speeds, refer to the ATV320 Programming Manual ([NVE41295](#)).

## Brake Control Sequence

### Overview

This function is available in both ATV312 and ATV320 drives but configuration of this function is not the same.

### Device Conversion

Conversion from an ATV312 configuration into ATV320 configuration is not supported for this function. The parameters related to this function are set to factory setting values and needs to be adjusted depending on the application. For more information about Brake Control Sequence, refer to the ATV320 Programming Manual ([NVE41295](#)).

## +/- Speed

### Overview

This function is available in both ATV312 and ATV320 drives.

### Device Conversion

Conversion from an ATV312 configuration into ATV320 configuration is supported for this function. For more information about +/- Speed, refer to the ATV320 Programming Manual ([NVE41295](#)).

## 2<sup>nd</sup> Current Limitation

### Overview

This function is available in both ATV312 and ATV320 drives.

### Device Conversion

Conversion from an ATV312 configuration into ATV320 configuration is supported for this function.

For more information about 2<sup>nd</sup> Current Limitation, refer to the ATV320 Programming Manual ([NVE41295](#)).

## Jump Frequency

### Overview

This function is available in both ATV312 and ATV320 drives.

ATV320 offers additional parameters for this function.

### Device Conversion

Conversion from an ATV312 configuration into ATV320 configuration is supported for this function.

For more information about Jump Frequency, refer to the ATV320 Programming Manual ([NVE41295](#)).

## PID Regulator

### Overview

This function is available in both ATV312 and ATV320 drives.

ATV312 offers a PI Regulator.

ATV320 offers a PID Regulator.

### Device Conversion

Conversion from an ATV312 configuration into ATV320 configuration is not supported for this function.

The parameters related to this function are set to factory setting values and needs to be adjusted depending on the application.

For more information about PID Regulator, refer to the ATV320 Programming Manual ([NVE41295](#)).

## Internal PID reference

### Overview

This function is available in both ATV312 and ATV320 drives but configuration of this function is not the same.

### Device Conversion

Conversion from an ATV312 configuration into ATV320 configuration is not supported for this function.

The parameters related to this function are set to factory setting values and needs to be adjusted depending on the application.

For more information about Internal PID reference, refer to the ATV320 Programming Manual ([NVE41295](#)).



## Preset PID Reference

### Overview

This function is available in both ATV312 and ATV320 drives but configuration of this function is not the same.

### Device Conversion

Conversion from an ATV312 configuration into ATV320 configuration is not supported for this function. The parameters related to this function are set to factory setting values and needs to be adjusted depending on the application.

For more information about Internal Preset PID Reference, refer to the ATV320 Programming Manual ([NVE41295](#)).

## Sleep / Wake-Up

### Overview

This function is available in both ATV312 and ATV320 drives but configuration of this function is not the same.

### Device Conversion

Conversion from an ATV312 configuration into ATV320 configuration is not supported for this function. The parameters related to this function are set to factory setting values and needs to be adjusted depending on the application.

For more information about Sleep / Wake-Up, refer to the ATV320 Programming Manual ([NVE41295](#)).

## Catch On the Fly

### Overview

This function is available in both ATV312 and ATV320 drives.

### Device Conversion

Conversion from an ATV312 configuration into ATV320 configuration is supported for this function.

For more information about Catch On the Fly, refer to the ATV320 Programming Manual ([NVE41295](#)).

## Automatic Restart

### Overview

This function is available in both ATV312 and ATV320 drives.

### Device Conversion

Conversion from an ATV312 configuration into ATV320 configuration is supported for this function.

For more information about Automatic Restart, refer to the ATV320 Programming Manual ([NVE41295](#)).

## Multi-Motors / Multi-Configurations

### Overview

This function is available in both ATV312 and ATV320 drives but configuration of this function is not the same.

### Device Conversion

Conversion from an ATV312 configuration into ATV320 configuration is not supported for this function.

The parameters related to this function are set to factory setting values and needs to be adjusted depending on the application.

For more information about Multi-Motors / Multi-Configurations, refer to the ATV320 Programming Manual ([NVE41295](#)).



