

mitsubishi

A8GT-70KBF External I/O Module

Mitsubishi Graphic Operation Terminal User's Manual

Thank you for choosing the Mitsubishi General Purpose PC Graphic Operation Terminal 800 series. To ensure correct use of this equipment, please read this manual carefully before operating it.



MODEL	A8GT-70KBF-U-E
MODEL CODE	13JL17

IB-NA-66769-A (9706)MEE

●SAFETY PRECAUTIONS●

(Read these precautions before using.)

When using Mitsubishi equipment, thoroughly read this manual and the associated manuals introduced in this manual. Also pay careful attention to safety and handle the module properly.

These precautions apply only to Mitsubishi equipment. Refer to the CPI module user's manual for a description of the PC system safety precautions.

These ●SAFETY PRECAUTIONS● classify the safety precautions into two categories: "DANGER" and "CAUTION"

DANGER

Procedures which may lead to a dangerous condition and cause death or serious injury if not carried out properly.

CAUTION

Procedures which may lead to a dangerous condition and cause superficial to medium injury, or physical damage only, if not carried out properly.

Depending on circumstances, procedures indicated by  CAUTION may also be linked to serious results.

In any case, it is important to follow the directions for usage.

Store this manual in a safe place so that you can take it out and read whenever necessary. Always forward it to the end user.

[DESIGN PRECAUTIONS]

DANGER

- Some faults of the GOT, this unit or connection cables may keep the outputs on or off.

An external monitoring circuit should therefore be provided to check for output signals which may lead to a serious accident.

Otherwise, mis-output or misoperation can cause an accident.

[INSTALLATION PRECAUTIONS]

DANGER

- When installing and removing this module from the GOT main module be sure to shut off the power at all external switches. If all the switches are not turned off, the module could be damaged or malfunction.
- When connecting the bus connection cable to this module be sure to turn off the switch to all external power switches to the GOT and PC CPU. If all the switches are not turned off, it may cause malfunction.

CAUTION

- Use this module in an environment that is within the general specifications written in the GOT User's Manual. If the power supply is used in an environment that is outside of the general specifications then electric shock, fire, malfunction, or product damage or degradation could occur.
- For a correct installation, insert the bus connection cable to this module, A7GT-BUS2S, bus connector conversion module, and base unit connector until you hear it click.
A bad connection could cause erroneous input or output.
- When installing this module in the GOT main module, install it in the GOT installation area and be sure it is fastened with a module fastening screw that is tightened within the specified torque range.
If the module fixing screws are loosen, it may cause malfunction, damage or falling of the module.
If the module fixing screws are too tight, the GOT main module or the screws could break.

[Wiring Instructions]

DANGER

- Before starting wiring, always switch off all phases of the power supply externally.

CAUTION

- During wiring, care should be taken so that foreign matter such as shield and wire offcuts do not enter this unit.
Otherwise, a fire, fault or misoperation can occur.

[STARTING AND MAINTENANCE PRECAUTIONS]

DANGER

- Do not change the switch setting while power is on.
- Switch all phases of the GOT external power supply off before cleaning. Not doing so could result in electric shock.

CAUTION

- Never disassemble or modify the module. This may cause breakdowns, malfunctioning, injury, and/or fire.
- Do not directly touch the conducted area and electric parts of this module. It may cause damage and malfunctioning of the module.
- This module is made of resinous materials, and should be protected from strong shock or impact. It may cause breakdown.

[DISPOSAL PRECAUTIONS]

CAUTION

- When disposing of this product, treat it as industrial waste.

About This Manual

The following product manuals are available. Please use this table as a reference to request the appropriate manual as necessary.

Detailed Manual

Manual Name	Manual No. (Type Code)
A870GOT Graphic Operation Terminal User's Manual (Packaged with the A870GOT)	IB-66628 (13J830)
A810GOT Graphic Operation Terminal Additional Manual (Packaged with the A810GOT)	IB-66766 (13JL14)
Compact Building Block Type I/O Module User's Manual (Optional)	IB-66541 (13JE81)
Building Block Type I/O Module User's Manual (Optional)	IB-66140 (13J643)
GOT Upgrade Additional Manual (Packaged with the Software Package Product Packing)	IB-66744 (13J888)

Revisions

* The manual number is noted at the lower left of the back cover.

Print Date	*Manual Number	Revision
Jun. 1997	IB (NA)-66769-A	First printing

This manual confers no industrial property rights or any rights of any other kind, nor does it confer any patent licenses. Mitsubishi electric Corporation cannot be held responsible for any problems involving industrial property rights which may occur as a result of using the contents noted in this manual.

© 1997 Mitsubishi Electric Corporation

Table of Contents

1	Overview	1
2	Components Including in the Package	1
3	Specifications	2
4	System configuration	7
	4.1 System Configuration for No Outputs	7
	4.2 System Configuration for Outputs	8
	4.2.1 System configuration	8
	4.2.2 Connectio of external I/O unit and terminal block conversion unit.	10
	4.2.3 Connection of external inputs and external outputs to the terminal block conversion	12
5	User-fabricasted connection cables	14
	5.1 cable for connection between external I/O unit and original operator panel . . .	14
	5.2 cable for connection between external I/O unit and terminal block conversion unit.	16
6	Parts Identification	18
7.	Installation Procedure	19
8.	Outline Dimension Drawing	20

1 Overview

This user's manual gives the specifications, system configurations, parts identification, installation procedure and outline dimensions of the A8GT-70KBF type external I/O unit (referred to as the external I/O unit). The external I/O unit is fitted to the A870GOT/A810GOT type graphic operation terminal (referred to as the GOT) to receive up to 8/64 points of inputs and provide up to 16 points of outputs.

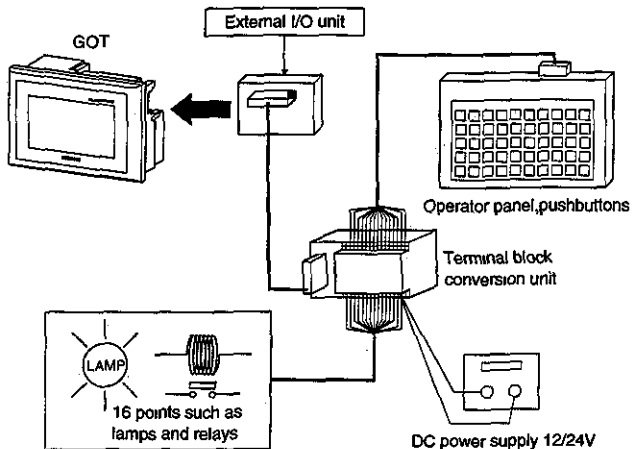

Note: This unit is used with the following versions of software:
SW2NIW-A8GOTP, SW2NIW-A8SYSP; version J or later

2 Components Including in the Package

After opening the container, check that the following products are present.

Description	Quantity
External I/O unit	1
External connector (soldered type)	1
This manual	1

3 Specifications

Input Specifications		
Input system	Dynamic scan	
Number of input points	8/64 points	
Isolation system	Photocoupler isolation	
Rated input voltage	12VDC	24VDC
Rated input current	Approx. 4mA	Approx. 9mA
Operating voltage range	10.2 to 26.4VDC (ripple percentage within 5%)	
Max. number of simultaneous input points	100% simultaneous ON (at 26.4VDC)	
ON voltage/ON current	8VDC or more/2mA or more	
OFF voltage/OFF current	4VDC or less/1mA or less	
Input resistance	Approx. 2.4K Ω	
Response time *1	ON to OFF	Approx. 0.4ms or less (24VDC)
	OFF to ON	Approx. 0.4ms or less (24VDC)
Dynamic scan cycle	13.3ms	

Output Specifications		
Output system	Direct	
Number of output points	16 points	
Isolation system	Photocoupler isolation	
Rated load voltage	12/24VDC	
Max. load current*4	0.1A/1 point	
Operating load voltage range	10.2 to 26.4VDC (ripple percentage within 5%)	
Max. inrush current	0.4A	
Leakage current at OFF	0.1mA or less	
Max. voltage drop at ON	2.5VDC (0.1A)	
Response time*1	ON to OFF	2ms or less
	OFF to ON	2ms or less (resistive load)
Surge suppressor	Clamp diode	

I/O Specifications		
External connection system	40-pin connector	
Applicable wire size	0.3mm ²	
Operation indicator	None	
External supply power	Voltage*3	12/24VDC (10.2 to 26.4V, ripple percentage 5% or less)
	Current	1.65A for external output 0.05A for internal consumption only
Fuse rating*2	2.0A fuse, unreplaceable	
Internal current consumption	0.1A	
Weight	170g(0.37lb)	
Accessory	1 piece of external wiring connector (soldered type)	

*1: Time in the I/O section.

*2: The fuse in the output unit is provided to prevent the external wiring from burning out if the outputs of the unit are shorted.

Therefore, it may not protect the output elements.

The fuse may not be blown if the output elements are damaged in the fault mode other than a short circuit.

*3: A fuse-blown error will also be displayed when the external supply power switches off.

*4: The maximum load current varies with the number of simultaneous ON points. Refer to the following information:

Relationships between output load current (common current), number of simultaneous ON points and ambient temperature

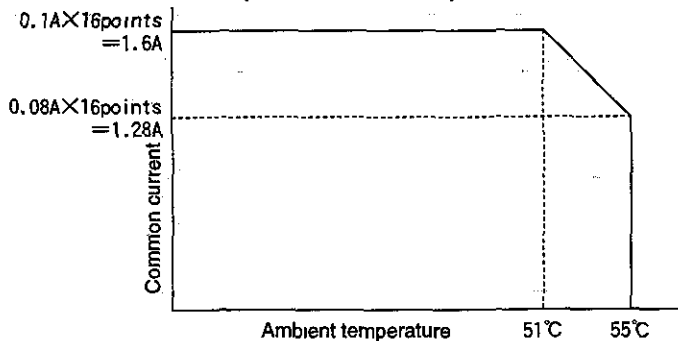

External Connector Pin-Outs

View from the unit front

Connector used: Fujitsu's FCN-364P040-AU

B1 B2 B3 B4 B5 B6 B7 B8 B9 B10B11B12B13B14B15B16B17B18B19B20

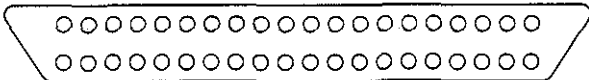

A1 A2 A3 A4 A5 A6 A7 A8 A9 A10A11A12A13A14A15A16A17A18A19A20

Pin Numbers and Signal Names of External Connector

Pin Number	Signal Name	Pin Number	Signal Name
1A	XD7	1B	XD6
2A	XD5	2B	XD4
3A	XD3	3B	XD2
4A	XD1	4B	XD0
5A	XSCN7	5B	XSCN8
6A	XSCN5	6B	XSCN4
7A	XSCN3	7B	XSCN2
8A	XSCN1	8B	XSCN0
9A	YDF	9B	YDE
10A	YDD	10B	YDC
11A	YDB	11B	YDA
12A	YD9	12B	YD8
13A	YD7	13B	YD6
14A	YD5	14B	YD4
15A	YD3	15B	YD2
16A	YD1	16B	YD0
17A	HOT24/12	17B	HOT24/12
18A	HOT24/12	18B	RTN24/12
19A	RTN24/12	19B	
20A		20B	FG

External Connection Diagram (1) (8-point inputs, 16-point outputs)

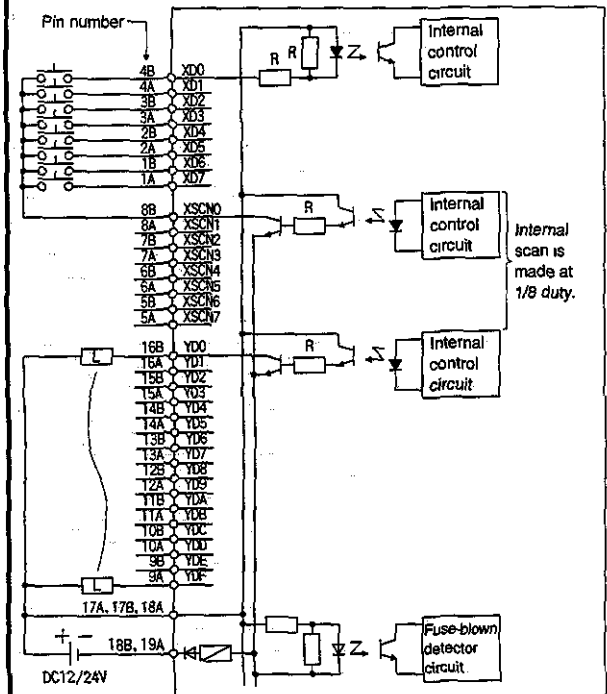

*1: A fuse-blown error will also be displayed when the external supply power switches off.

*2: The fuse in the output unit is provided to prevent the external wiring from burning out if the outputs of the unit are shorted.

Therefore, it may not protect the output elements.

The fuse may not be blown if the output elements are damaged in the fault mode other than a short circuit.

External Connection Diagram (2) (64-point inputs, 16-point outputs)

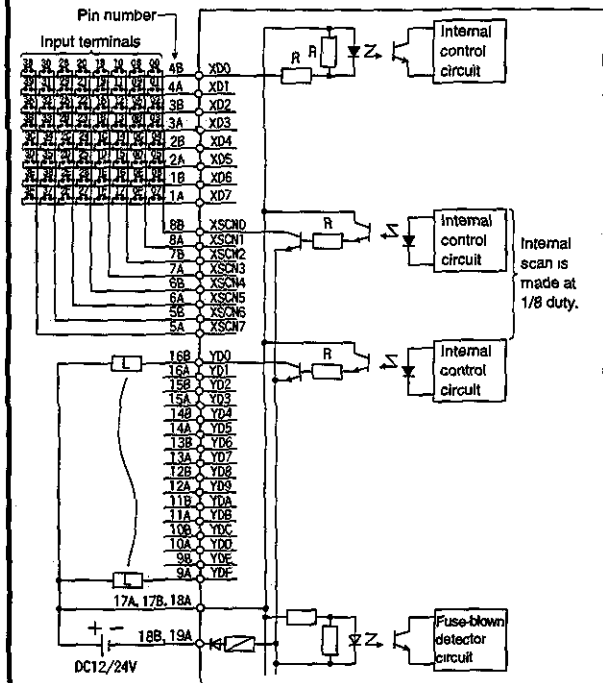

*1: When there is a probability that two or more switches are pressed simultaneously, each switch must be provided with a diode.

(Refer to the right figure.)

*2: A fuse-blown error will also be displayed when the external supply power switches off.

*3: The fuse in the output unit is provided to prevent the external wiring from burning out if the outputs of the unit are shorted.

Therefore, it may not protect the output elements.

The fuse may not be blown if the output elements are damaged in the fault mode other than a short circuit.

4 System Configuration

The system configuration depends on whether the external I/O unit provides outputs or not.

4.1 System Configuration for No Outputs

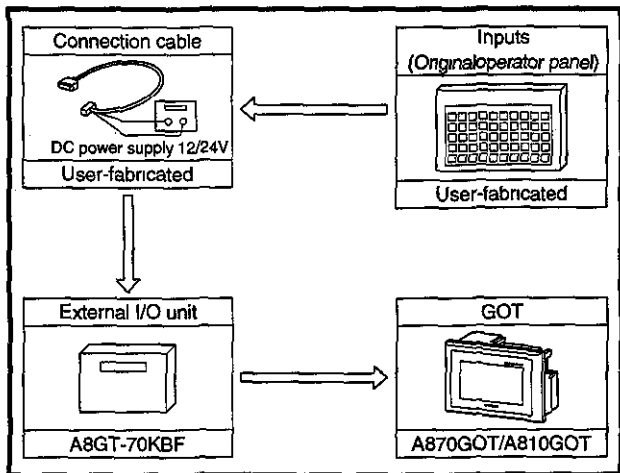

4.2 System Configuration for Outputs

4.2.1 System configuration

(1) For 8-point inputs

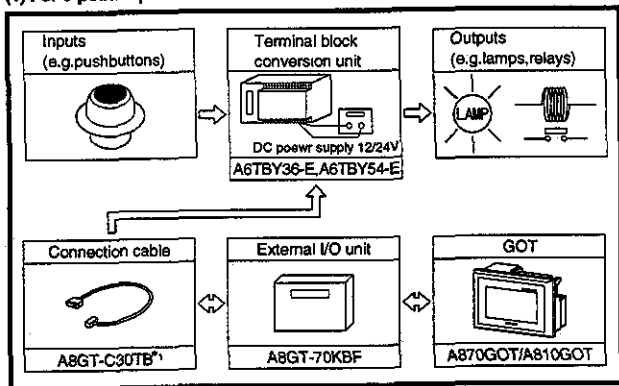

* 1 The cable for connection between external I/O unit and terminal block conversion unit may also be fabricated by the user.

(2) For 64-point inputs

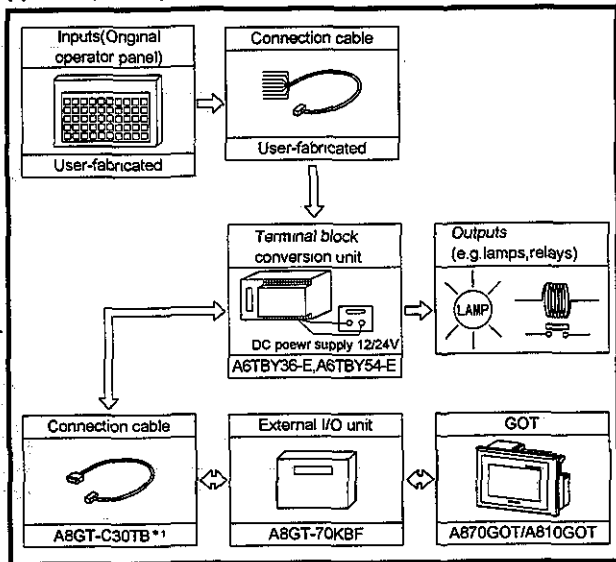

* 1 The cable for connection between external I/O unit and terminal block conversion unit may also be fabricated by the user.

4.2.2 Connection between the external I/O unit and terminal block conversion unit

(1) For use of the terminal block conversion unit (A6TBY36-E)

Cable for connection
between external
I/O unit and
terminal block
conversion unit

A8GT-70KBF

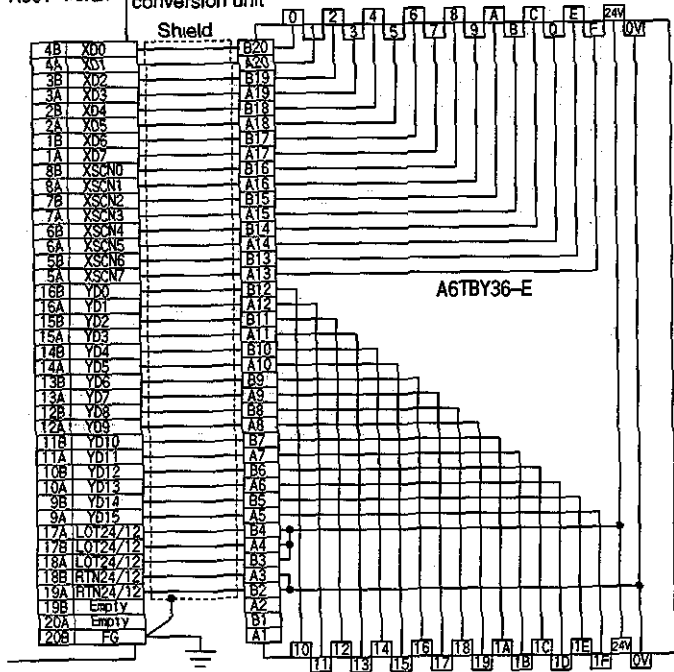

(2) For use of the terminal block conversion unit (A6TBY54-E)

Cable for connection
between external
I/O unit and
terminal block
conversion unit

A8GT-70KBF

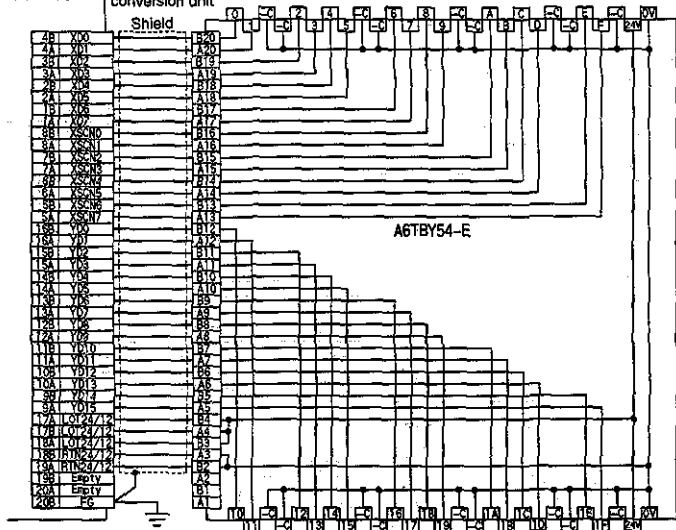

4.2.3 Connection of external inputs and external outputs to the terminal block conversion unit.

(1) For use of the terminal block conversion unit (A6TBY36-E)

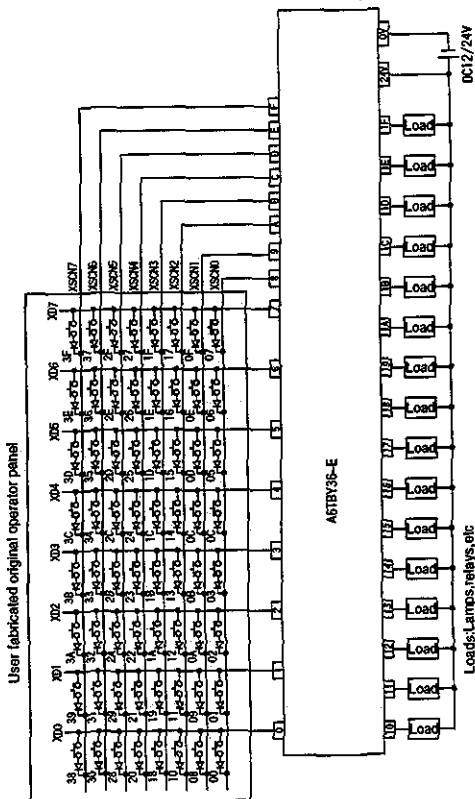

(2) For use of the terminal block conversion unit (A6TBY54-E)

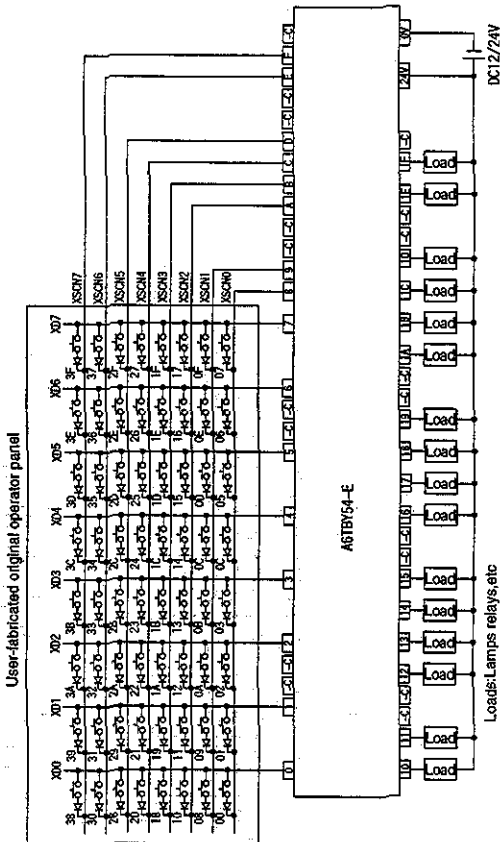

5. User-fabricated Connection Cables

The following is the way of fabricating the connection cable which can be fabricated by the user:

5.1 Cable for connection between external I/O unit and original operator panel

Fabricate the connection cable in accordance with the following wiring diagram, parts diagram and assembly drawing:

(1) A wiring diagram

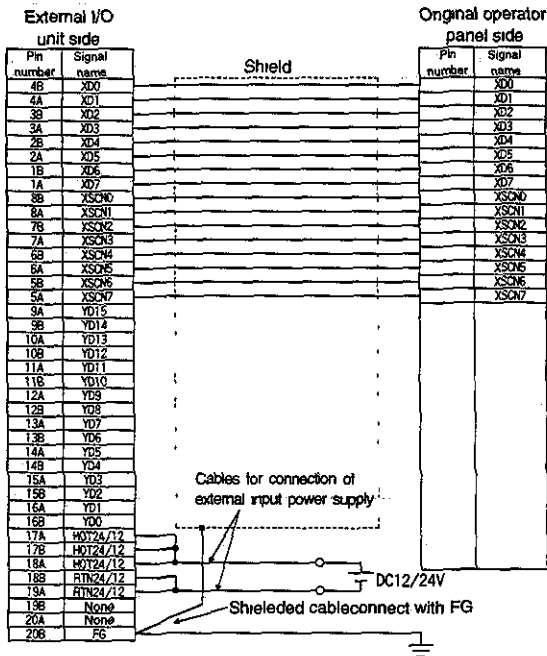

(2) Parts list

Part number	Name	Type	Quantity	Maker
①	Connector	FCN-361J040-AU	1	FUJITSU LTD
②	connector cover	FCN-360C040-B	1	
③	paired shielded cable	UL 2464 AWG ² 26×20P	1	Old Electric Cable Co., Ltd
④	FG cable	UL 1015 AWG14 or equivalent	1	-
⑤	Cable for connection of external input power supply.	-	2	-

(3) Assembly

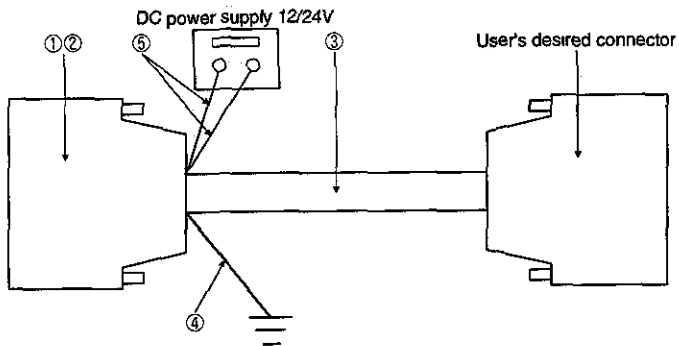

POINT

- The cable fabricated should be within 3m in length
- Connect the FG cable to the nearest ground

5.2 cable for connection between external I/O unit and terminal block conversion unit.

Fabricate the connection cable in accordance with the following wiring diagram, parts diagram and assembly drawing:

(1) A wiring diagram

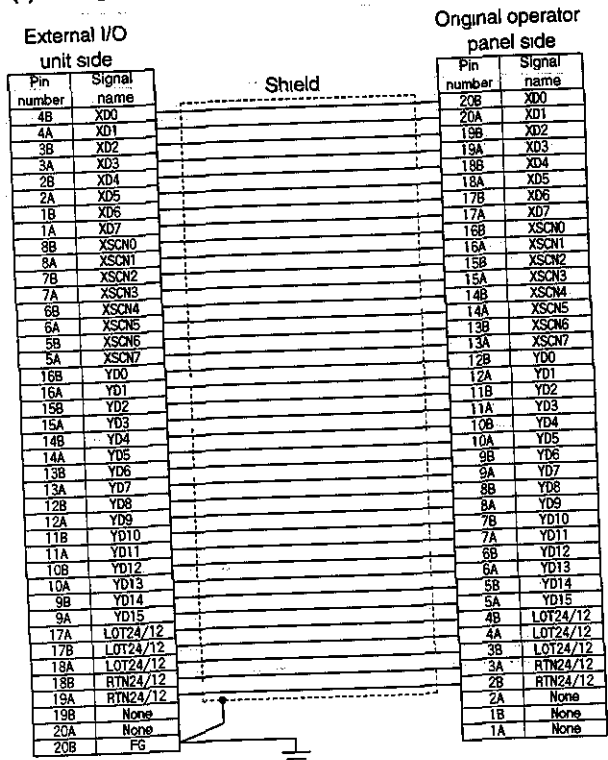

(2) Parts list

Part number	Name	Type	Quantity	Maker
①	Connector	FCN-361J040-AU	1	FUJITSU LTD
②	connector cover	FCN-360C040-B	1	
③	paired sealed cable	UL 2464 AWG ² 26×20P	1	Oki Electric Cable Co.,Ltd
④	FG cable	UL 1015 AWG14 or equivalent	1	—

(3) Assembly

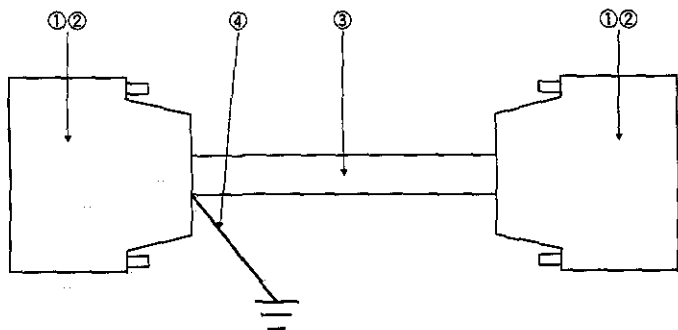

POINT

- The cable fabricated should be within 3m in length
- Connect the FG cable to the nearest ground

6 Parts Identification

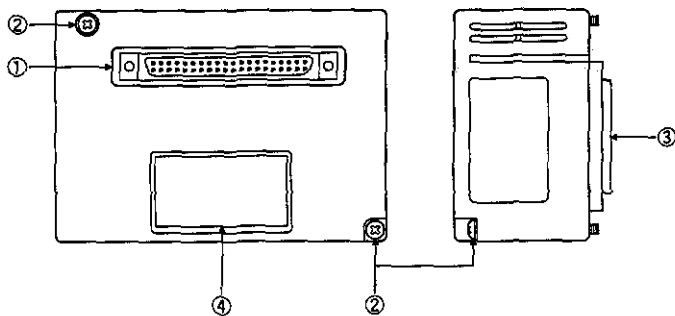
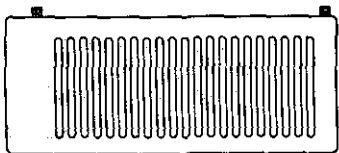

No.	Name	Description
①	I/O cable connection interface	Interface for connection of the I/O cable
②	Unit fixing screws	Screws used to fix the unit to the GOT
③	Connector	Connector used to plug the unit to the GOT.
④	Rating plate	—

7. Installation Procedure

Install the unit to the GOT in the following procedure:

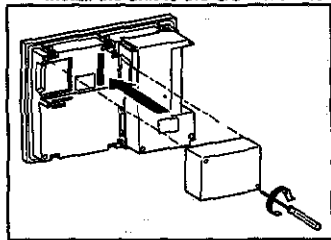

- 1) Insert the connector of the external I/O unit into the unit connection interface on top of the GOT.
- 2) Tighten the unit fixing screws (2 pcs.) to the specified torque of 39 to 59N cm (4 to 6kg cm).

To remove the unit, reverse the installation procedure.

8 Outline Dimension Drawing

Unit:mm(Inch)

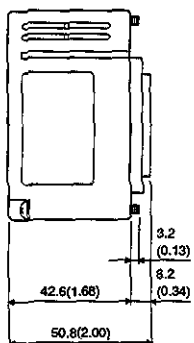
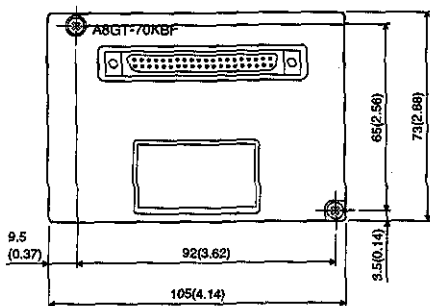
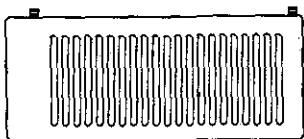

The United States	Mitsubishi Electronics America, Inc., (Industrial Automation Division) 800 Blemann Court, Mt. Prospect, IL 60056. Phone : (708) 298-9223
Canada	Mitsubishi Electric Sales Canada, Inc., (Industrial Automation Division) 4299 14th Avenue, Markham, Ontario L3R 0J2 Phone : (416) 475-7728
United Kingdom	Mitsubishi Electric UK Ltd., (Industrial Sales Division) Travellers Lane, Hatfield, Herts., AL10 8XB Phone : (0707) 276100
Germany	Mitsubishi Electric Europe GmbH, (Industrial Automation Division) Gothaer Strasse 8, Postfach 1548, D-4030 Ratingen 1 Phone : (02102) 4860
Taiwan	Setsuyo Enterprise Co., Ltd., (106) 11th Fl., Chung-Ling Bldg., 363, Sec. 2, Fu-Hsing S. Rd., Taipei, Taiwan, R.O.C. Phone : (02) 732-0161
Hongkong (& China)	Ryoden International Ltd., (Industrial & Electrical Controls Division) 10/F., Manulife Tower, 169 Electric Rd., North Point, Hong Kong. Phone : 8878870
Singapore (& Malaysia)	MELCO Sales Singapore Pte. Ltd., (Industrial Division) 307 Alexandra Rd. #05-01/02, Mitsubishi Electric Bldg., Singapore 0315. Phone : 4732308
Thailand	F.A. Tech Co., Ltd., 1138/33-34 Rama 3 Rd., Yannawa, Bangkok 10120. Phone : (02) 295-2861-4
Australia	Mitsubishi Electric Australia Pty. Ltd., (Industrial Controls Division) 348 Victoria Rd., Rydalm ere, N.S.W. 2116. Phone : (02) 684-7200
Republic of South Africa	M.S.A. Manufacturing (Pty) Ltd., (Factory Automation Division) P.O. Box 39733, Bramley, Johannesburg 2018. Phone : (011) 444-8080



MITSUBISHI ELECTRIC CORPORATION

HEAD OFFICE: MITSUBISHI DENKI BLDG. 5F, 2-3-1 YAMATECHO, TOKYO 100 JAPAN
TELEX: 24343 GABE JELCO TOKYO
NAGOYA WORKS: 1-14 YASUAKINASHI 3, NISHIKAWA, NAHOYA, JAPAN

When exported from Japan, this manual does not require application to the
Ministry of International Trade and Industry for service transaction permission.