

**NT631 and NT631C**

# **Programmable Terminals**

## **Setup Manual**

**OMRON**



# NT631 and NT631C Programmable Terminals

## Setup Manual

*Revised October 2011*

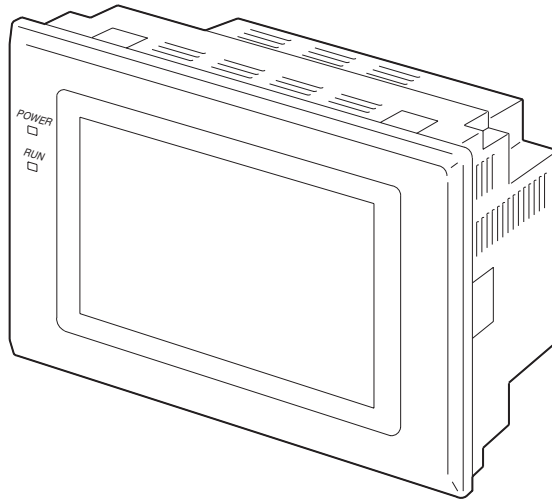





## **Notice:**

OMRON products are manufactured for use according to proper procedures by a qualified operator and only for the purposes described in this manual.

The following conventions are used to indicate and classify precautions in this manual. Always heed the information provided with them. Failure to heed precautions can result in injury to people or damage to property.

 **DANGER** Indicates an imminently hazardous situation which, if not avoided, will result in death or serious injury. Additionally, there may be severe property damage.

 **WARNING** Indicates a potentially hazardous situation which, if not avoided, could result in death or serious injury. Additionally, there may be severe property damage.

 **Caution** Indicates a potentially hazardous situation which, if not avoided, may result in minor or moderate injury, or property damage.

## **OMRON Product References**

All OMRON products are capitalized in this manual. The word “Unit” is also capitalized when it refers to an OMRON product, regardless of whether or not it appears in the proper name of the product.

The abbreviation “Ch,” which appears in some displays and on some OMRON products, often means “word” and is abbreviated “Wd” in documentation in this sense.

The abbreviation “PLC” means Programmable Controller. “PC” is used, however, in some Programming Device displays to mean Programmable Controller.

## **Visual Aids**

The following headings appear in the left column of the manual to help you locate different types of information.

**Note** Indicates information of particular interest for efficient and convenient operation of the product.

**1,2,3...** 1. Indicates lists of one sort or another, such as procedures, checklists, etc.

## **© OMRON, 2000**

All rights reserved. No part of this publication may be reproduced, stored in a retrieval system, or transmitted, in any form, or by any means, mechanical, electronic, photocopying, recording, or otherwise, without the prior written permission of OMRON.

No patent liability is assumed with respect to the use of the information contained herein. Moreover, because OMRON is constantly striving to improve its high-quality products, the information contained in this manual is subject to change without notice. Every precaution has been taken in the preparation of this manual. Nevertheless, OMRON assumes no responsibility for errors or omissions. Neither is any liability assumed for damages resulting from the use of the information contained in this publication.



# TABLE OF CONTENTS

|   |            |
|---|------------|
| <b>PRECAUTIONS</b> .....                                      | <b>xv</b>  |
| 1 Intended Audience .....                                     | xvi        |
| 2 General Precautions .....                                   | xvi        |
| 3 Safety Precautions .....                                    | xvi        |
| <br>  |            |
| <b>SECTION 1</b>  |            |
| <b>General</b> .....  | <b>1</b>   |
| 1-1 Role and Operation of the NT631/NT631C .....              | 2          |
| 1-2 Functions of the NT631/NT631C .....                       | 4          |
| 1-3 System Configuration .....                                | 16         |
| 1-4 Communications with the Host .....                        | 18         |
| 1-5 Communications Using Memory Links .....                   | 21         |
| 1-6 Before Operating .....                                    | 23         |
| <br>  |            |
| <b>SECTION 2</b>  |            |
| <b>Preparing for Connection</b> .....                         | <b>25</b>  |
| 2-1 Method for Connection to the Host .....                   | 26         |
| 2-2 Names and Functions of Parts .....                        | 29         |
| <br>  |            |
| <b>SECTION 3</b>  |            |
| <b>Hardware Settings and Connections</b> .....                | <b>31</b>  |
| 3-1 Installation .....  | 32         |
| 3-2 Connecting to the Support Tool .....                      | 35         |
| 3-3 Connecting a Printer .....                                | 36         |
| 3-4 Connecting a Bar Code Reader .....                        | 36         |
| 3-5 Using a Memory Unit .....                                 | 39         |
| <br>  |            |
| <b>SECTION 4</b>  |            |
| <b>Connecting to the Host from the RS-232C Port</b> .....     | <b>47</b>  |
| 4-1 Connecting to the RS-232C Port at the Host .....          | 48         |
| <br>  |            |
| <b>SECTION 5</b>  |            |
| <b>Connecting to the Host from the RS-422A/485 Port</b> ..... | <b>79</b>  |
| 5-1 Connecting to the Host's RS-232C Port .....               | 80         |
| 5-2 Connecting to the Host's RS-422A/485 Port .....           | 93         |
| <br>  |            |
| <b>SECTION 6</b>  |            |
| <b>System Menu Operation</b> .....                            | <b>127</b> |
| 6-1 System Menu Operation Flow .....                          | 129        |
| 6-2 Starting the NT631/NT631C .....                           | 129        |
| 6-3 Operation Modes and the System Menu .....                 | 130        |
| 6-4 Memory Initialization .....                               | 135        |

# TABLE OF CONTENTS

|  |   |            |
|--|---|------------|
| 6-5  | Operations in the System Installer Mode.....                                  | 144        |
| 6-6  | Transmitting the Screen Data .....  | 149        |
| 6-7  | Setting Conditions for Communications with Host by Using Memory Switches..... | 152        |
| 6-8  | Starting Operation .....  | 163        |
| 6-9  | Various System Settings .....   | 164        |
| 6-10   | Setting the Bar Code Reader Input Function.....                               | 184        |
| 6-11   | System Maintenance .....  | 187        |
| 6-12   | Programming Console Function .....  | 214        |
| 6-13   | Device Monitor Function.....  | 220        |
| 6-14   | Version Display .....   | 223        |
| <b>SECTION 7</b>                             |   |            |
| <b>Troubleshooting and Maintenance .....</b> |   | <b>225</b> |
| 7-1  | Troubleshooting.....  | 226        |
| 7-2  | Responding to Displayed Error Messages.....                                   | 229        |
| 7-3  | Maintenance of the NT631/NT631C.....  | 235        |
| 7-4  | Inspection and Cleaning .....   | 242        |
| <b>Appendices</b>                            |   |            |
| A  | Specifications .....  | 245        |
| B  | Dimensions .....  | 255        |
| C  | Using an RS-232C/RS-422A Adapter .....  | 259        |
| D  | Transporting and Storing the NT631/NT631C .....                               | 265        |
| E  | Making the Cable .....  | 267        |
| F  | Making the Cable for Connecting a PLC .....                                   | 271        |
| G  | Making the Cable for Connection to a Bar Code Reader .....                    | 273        |
| H  | Making the Cable for Connection to a Printer .....                            | 275        |
| I  | Relationship between system program and hardware .....                        | 277        |
| J  | Model List .....  | 281        |
| K  | Option List .....   | 287        |
| <b>Index.....</b>                            |   | <b>291</b> |
| <b>Revision History .....</b>                |   | <b>295</b> |



## ***About this Manual:***

This manual describes connecting the NT-series NT631 and NT631C Programmable Terminals (PTs) to a PLC (Programmable Controller) or other host and peripheral devices, and the settings required for communications and applications. It includes the sections described below.

Please read this manual carefully and be sure you understand the information provided before attempting to install and operate the Programmable Terminal.

**Section 1** provides fundamental information about the functions and features of the PTs, types of connection, communications methods, etc. This information will enable you to understand the applications of the PTs.

**Section 2** describes the connection methods that are possible with the PTs, and the functions of the parts of PTs, as the required knowledge before connecting to the host and to the peripheral devices.

**Section 3** describes the settings of the PTs and methods for connection to peripheral devices.

**Section 4** describes the method for connecting to the host using the RS-232C port of the PT.

**Section 5** describes the method for connecting to the host using the RS-422A/485 port of the PT.

**Section 6** describes the operation of the System Menu, focusing on the procedure to start the PT. Functions that are convenient when using the PT and those that are useful for system maintenance are also explained here.

**Section 7** describes the action to take when errors occur in the PT, and how to carry out maintenance and inspection to prevent the occurrence of errors.

The **Appendices** provide specifications, dimensions, procedures for using an RS-232C/RS-422A Adapter, procedures for transporting and storing the PT, information on cable preparation, information on the relationship between the system program and hardware, and product lists.



**WARNING** Failure to read and understand the information provided in this manual may result in personal injury or death, damage to the product, or product failure. Please read each section in its entirety and be sure you understand the information provided in the section and related sections before attempting any of the procedures or operations given.

## ***Related Manuals:***

Related manuals are listed below.

The □ symbol at the end of the catalog number is the revision number.

### **Connecting and Setting Up the Programmable Terminal**

- NT631 and NT631C PT Setup Manual (V063-E1-□, this manual)

This manual describes connecting the Programmable Terminals to a host and peripheral devices and settings required for communications and applications.

The functions and actual operating methods for the NT631 and NT631C PTs are provided in the *Reference Manual* (V064-E1-□).

### **Programmable Terminal Functions and Operation**

- NT31/31C/631/631C PT Reference Manual (V064-E1-□)

This manual is used for any of the following PTs: NT31, NT31C, NT631, and NT631C. It describes screen configurations, part functions, host control methods, and other application information.

PT connection and setup procedures are described in the *NT631 and NT631C PT Setup Manual* (V063-E1-□).

### **Creating and Transferring Screen Data, and Installing the System Program**

- NT-series Support Tool for Windows Ver. 4.□ Operation Manual (V061-E1-□)

The screens displayed on the NT631 and NT631C PTs are created with the Support Tool and transferred to the PT. This manual describes how to create and transfer screen data. It also describes how to download a system program to a PT using the System Installer.

The NT-series Support Tool for Windows is normally referred to as merely the Support Tool.

### **Connecting to Controllers Not Made by OMRON**

- PLC Connection Manual (V042-E1-□)

The NT631 and NT631C PTs can be connected to controllers in the following series: Mitsubishi A Series and FX Series. This manual describes the connection and setup methods for these controllers.

The NT-series Support Tool for Windows Version 4.□ is required to connect the NT631 and NT631C PTs to these controllers.

- NT31/NT631 Multi Vendor Connection Manual (V060-E1-□)

The NT631 and NT631C PTs can be connected to controllers in the following series: Allen-Bradley SLC 500 Series, GE Fanuc 90-20 and 90-30 Series, and Siemens S7-300 and S7-400 Series. This manual describes the connection and setup methods for these controllers.

## ***Read and Understand this Manual***

Please read and understand this manual before using the product. Please consult your OMRON representative if you have any questions or comments.

## ***Warranty and Limitations of Liability***

### ***WARRANTY***

OMRON's exclusive warranty is that the products are free from defects in materials and workmanship for a period of one year (or other period if specified) from date of sale by OMRON.

OMRON MAKES NO WARRANTY OR REPRESENTATION, EXPRESS OR IMPLIED, REGARDING NON-INFRINGEMENT, MERCHANTABILITY, OR FITNESS FOR PARTICULAR PURPOSE OF THE PRODUCTS. ANY BUYER OR USER ACKNOWLEDGES THAT THE BUYER OR USER ALONE HAS DETERMINED THAT THE PRODUCTS WILL SUITABLY MEET THE REQUIREMENTS OF THEIR INTENDED USE. OMRON DISCLAIMS ALL OTHER WARRANTIES, EXPRESS OR IMPLIED.

### ***LIMITATIONS OF LIABILITY***

OMRON SHALL NOT BE RESPONSIBLE FOR SPECIAL, INDIRECT, OR CONSEQUENTIAL DAMAGES, LOSS OF PROFITS OR COMMERCIAL LOSS IN ANY WAY CONNECTED WITH THE PRODUCTS, WHETHER SUCH CLAIM IS BASED ON CONTRACT, WARRANTY, NEGLIGENCE, OR STRICT LIABILITY.

In no event shall the responsibility of OMRON for any act exceed the individual price of the product on which liability is asserted.

IN NO EVENT SHALL OMRON BE RESPONSIBLE FOR WARRANTY, REPAIR, OR OTHER CLAIMS REGARDING THE PRODUCTS UNLESS OMRON'S ANALYSIS CONFIRMS THAT THE PRODUCTS WERE PROPERLY HANDLED, STORED, INSTALLED, AND MAINTAINED AND NOT SUBJECT TO CONTAMINATION, ABUSE, MISUSE, OR INAPPROPRIATE MODIFICATION OR REPAIR.

# ***Application Considerations***

## ***SUITABILITY FOR USE***

OMRON shall not be responsible for conformity with any standards, codes, or regulations that apply to the combination of products in the customer's application or use of the products.

At the customer's request, OMRON will provide applicable third party certification documents identifying ratings and limitations of use that apply to the products. This information by itself is not sufficient for a complete determination of the suitability of the products in combination with the end product, machine, system, or other application or use.

The following are some examples of applications for which particular attention must be given. This is not intended to be an exhaustive list of all possible uses of the products, nor is it intended to imply that the uses listed may be suitable for the products:

- Outdoor use, uses involving potential chemical contamination or electrical interference, or conditions or uses not described in this manual.
- Nuclear energy control systems, combustion systems, railroad systems, aviation systems, medical equipment, amusement machines, vehicles, safety equipment, and installations subject to separate industry or government regulations.
- Systems, machines, and equipment that could present a risk to life or property.

Please know and observe all prohibitions of use applicable to the products.

**NEVER USE THE PRODUCTS FOR AN APPLICATION INVOLVING SERIOUS RISK TO LIFE OR PROPERTY WITHOUT ENSURING THAT THE SYSTEM AS A WHOLE HAS BEEN DESIGNED TO ADDRESS THE RISKS, AND THAT THE OMRON PRODUCTS ARE PROPERLY RATED AND INSTALLED FOR THE INTENDED USE WITHIN THE OVERALL EQUIPMENT OR SYSTEM.**

## ***PROGRAMMABLE PRODUCTS***

OMRON shall not be responsible for the user's programming of a programmable product, or any consequence thereof.

## ***Disclaimers***

### ***CHANGE IN SPECIFICATIONS***

Product specifications and accessories may be changed at any time based on improvements and other reasons.

It is our practice to change model numbers when published ratings or features are changed, or when significant construction changes are made. However, some specifications of the products may be changed without any notice. When in doubt, special model numbers may be assigned to fix or establish key specifications for your application on your request. Please consult with your OMRON representative at any time to confirm actual specifications of purchased products.

### ***DIMENSIONS AND WEIGHTS***

Dimensions and weights are nominal and are not to be used for manufacturing purposes, even when tolerances are shown.

### ***PERFORMANCE DATA***

Performance data given in this manual is provided as a guide for the user in determining suitability and does not constitute a warranty. It may represent the result of OMRON's test conditions, and the users must correlate it to actual application requirements. Actual performance is subject to the OMRON Warranty and Limitations of Liability.

### ***ERRORS AND OMISSIONS***

The information in this manual has been carefully checked and is believed to be accurate; however, no responsibility is assumed for clerical, typographical, or proofreading errors, or omissions.



# PRECAUTIONS

This section provides general precautions for using the Programmable Terminal.

The information contained in this section is important for the safe and reliable application of the Programmable Terminal. You must read this section and understand the information contained before attempting to set up or operate a Programmable Terminal.

|   |                           |     |
|---|---------------------------|-----|
| 1 | Intended Audience .....   | xvi |
| 2 | General Precautions ..... | xvi |
| 3 | Safety Precautions .....  | xvi |

## 1 Intended Audience

This manual is intended for the following personnel, who must also have knowledge of electrical systems (an electrical engineer or the equivalent).

- Personnel in charge of introducing FA systems into production facilities.
- Personnel in charge of designing FA systems.
- Personnel in charge of installing and connecting FA systems.
- Personnel in charge of managing FA systems and facilities.

## 2 General Precautions

The user must operate the product according to the performance specifications described in the operation manuals.

Before using the product under conditions which are not described in the manual or applying the product to nuclear control systems, railroad systems, aviation systems, vehicles, combustion systems, medical equipment, amusement machines, safety equipment, and other systems, machines and equipment that may have a serious influence on lives and property if used improperly, consult your OMRON representative.

Make sure that the ratings and performance characteristics of the product are sufficient for the systems, machines, and equipment, and be sure to provide the systems, machines, and equipment with double safety mechanisms.

This manual provides information for using the Programmable Terminal. Be sure to read this manual before attempting to use the software and keep this manual close at hand for reference during operation.

 **WARNING** It is extremely important that Programmable Terminals and related devices be used for the specified purpose and under the specified conditions, especially in applications that can directly or indirectly affect human life. You must consult with your OMRON representative before applying Programmable Terminals to the above-mentioned applications.

 **WARNING** Do not use input functions such as PT touch switches for applications where danger to human life or serious damage is possible, or for emergency switch applications.

## 3 Safety Precautions

Read these safety precautions carefully and make sure you understand them before using the Programmable Terminal so that you can use it safely and correctly.

### Safety Conventions and their Meanings

This operation manual uses the following conventions and symbols to indicate cautions, warnings, and dangers in order to ensure safe use of the NT631/631C.

The cautions, warnings, and dangers shown here contain important information related to safety. This instructions in these cautions, warnings, and dangers must be observed.

The conventions used and their meanings are presented below.



 **WARNING** Indicates information that, if not heeded, could possibly result in loss of life or serious injury.

 **Caution** Indicates information that, if not heeded, could result in relatively serious or minor injury, damage to the product, or faulty operation.

 **WARNING**

Do not attempt to take the unit apart and do not touch any internal parts while the power is being supplied. Doing either of these may result in electrical shock.



 **WARNING**

Switch OFF the NT631C power before replacing the backlight. Otherwise you could sustain an electric shock.





# SECTION 1

## General

This section provides fundamental information about the functions and features of the NT631/NT631C, types of connection, communications methods, etc. This information will enable you to understand the applications of the NT631/NT631C.

|       |  |    |
|-------|--|----|
| 1-1   | Role and Operation of the NT631/NT631C . . . . .                   | 2  |
| 1-1-1 | Operation of an NT631/NT631C at an FA Production Site . . . . .    | 2  |
| 1-1-2 | Operations of the NT631/NT631C . . . . .                           | 3  |
| 1-2   | Functions of the NT631/NT631C . . . . .                            | 4  |
| 1-2-1 | Features . . . . .   | 4  |
| 1-2-2 | Comparison between NT631 and NT631C . . . . .                      | 7  |
| 1-2-3 | Comparison between NT620S/NT620C/NT625C and NT631/NT631C . . . . . | 8  |
| 1-2-4 | Principal Functions of NT631/NT631C . . . . .                      | 10 |
| 1-2-5 | Displays . . . . .   | 12 |
| 1-3   | System Configuration . . . . .                                     | 16 |
| 1-3-1 | Peripheral Devices That Can Be Connected . . . . .                 | 17 |
| 1-3-2 | Connecting to the Host . . . . .                                   | 18 |
| 1-4   | Communications with the Host . . . . .                             | 18 |
| 1-4-1 | Direct Connection Function . . . . .                               | 18 |
| 1-4-2 | Host Link . . . . .  | 19 |
| 1-4-3 | NT Link . . . . .  | 19 |
| 1-4-4 | Connecting to Other Companies' PLCs . . . . .                      | 21 |
| 1-5   | Communications Using Memory Links . . . . .                        | 21 |
| 1-5-1 | Memory Link . . . . .  | 21 |
| 1-5-2 | Comparison between Direct Connection and Memory Link . . . . .     | 22 |
| 1-5-3 | Memory Link Online Transfer Function . . . . .                     | 22 |
| 1-6   | Before Operating . . . . .   | 23 |

# 1-1 Role and Operation of the NT631/NT631C

The NT631/NT631C is a sophisticated display unit (Programmable Terminal) which automatically displays information and can also be used for operations when necessary. The following gives a general description of the role and operation of the NT631/NT631C for those using a programmable terminal (PT) for the first time.

## 1-1-1 Operation of an NT631/NT631C at an FA Production Site

### Production Line Status Monitoring

The NT631/NT631C displays real-time information about the system and equipment operating status, etc. Its power of expression is enhanced by graphs and other visuals, making the displays easy to understand.

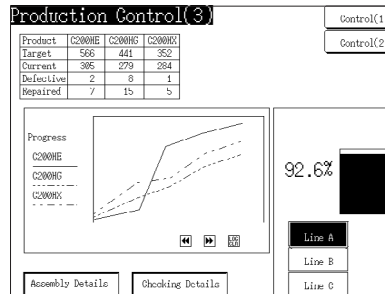

### Directions to Workers on the Shop Floor

The NT631/NT631C warns of system or equipment failures and prompts the appropriate remedial action.

## Alarm

Assembly line B

Positioning pin

is defective. Line stopped.

Check the following.

1. Defective pin L3
2. Position of dog M2
3. Mounting of photosensor P5

### Panel Switch Functions

Setting touch switches on the NT631/NT631C allows workers to use the NT631/NT631C as an operating panel; the results of the operations are transmitted to the host.

| Electroplating control  |   |  |   |
|---|---|--|---|
| Transport   | Electr. head  | Wash. head   | Corr. prv. head   |
| <div style="display: flex; justify-content: space-around;"> <div style="text-align: center;"> <p>↑</p> <p>← →</p> <p>↓</p> </div> <div style="border: 1px solid black; padding: 2px;">Clamp</div> <div style="border: 1px solid black; padding: 2px;">UP</div> <div style="border: 1px solid black; padding: 2px;">UP</div> <div style="border: 1px solid black; padding: 2px;">UP</div> </div> | <div style="border: 1px solid black; padding: 2px;">DOWN</div>  | <div style="border: 1px solid black; padding: 2px;">DOWN</div>         | <div style="border: 1px solid black; padding: 2px;">DOWN</div>  |
| <div style="border: 1px solid black; padding: 2px;">Int. stop</div>   | <div style="border: 1px solid black; padding: 2px;">Adv.</div> <div style="border: 1px solid black; padding: 2px;">Rev.</div> | <div style="border: 1px solid black; padding: 2px;">Electro-lyte</div> | <div style="border: 1px solid black; padding: 2px;">Wash</div> <div style="border: 1px solid black; padding: 2px;">Corr. prv. fluid</div> |

### 1-1-2 Operations of the NT631/NT631C

#### Displays Screens

The information to be displayed (screen data) can be created on a computer using the Support Tool and stored in the NT631/NT631C. The screen data can be displayed on the NT631/NT631C in response to instructions from the host or touch switch operation.

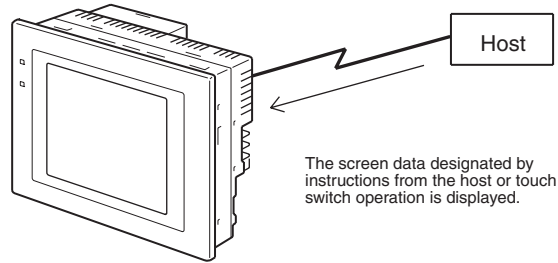

#### Receives Data from a Host

The NT631/NT631C can be connected to the host by a host link or NT link and receive necessary data from the host.

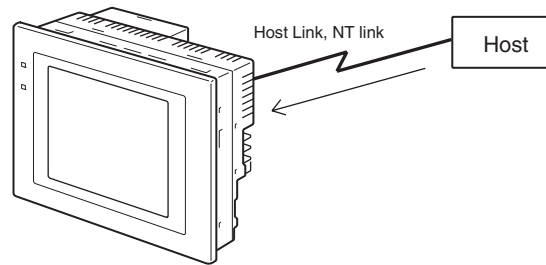

#### Sends Data to a Host

Data input using the touch panel (switch ON/OFF statuses, numeric values, character strings) can be transmitted to the host.

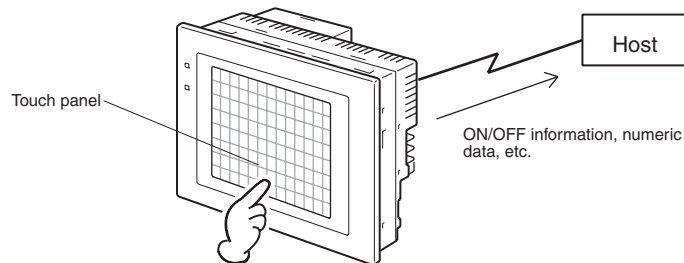

#### Screen Data

The screen data to be displayed on the NT631/NT631C can be created on a personal computer using the Support Tool. Connect the NT631/NT631C to the personal computer with an RS-232C cable and transmit the screen data to the NT631/NT631C.

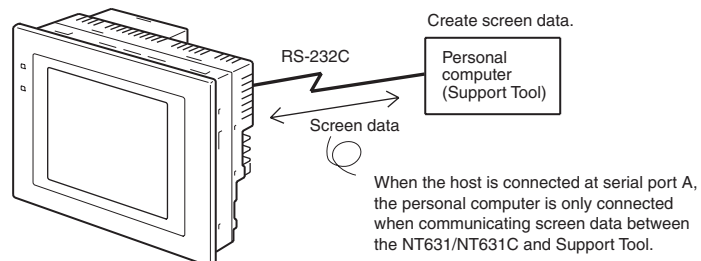

## 1-2 Functions of the NT631/NT631C

The NT631/NT631C has the following features.

### 1-2-1 Features

#### Slim Body

- High-performance in a low-profile body (50 mm or less in the panel\*).
- The communications cable connectors are housed in the PT so that they do not protrude from the PT.
- \* When mounted in a panel of the recommended thickness (page 32).

#### Construction Best Suited to the FA Environment

- The display panel is provided with a high-contrast monochrome EL display for the NT631-ST211□-EV2, an STN color LCD display with backlight for the NT631C-ST141□-EV2, and a TFT color LCD high-definition display for NT631C-ST153□-EV3.
- The backlight unit and battery can be replaced at the operation site. (The backlight for the NT631C-ST153□-EV3, however, cannot be replaced by the user.)
- Protection equivalent to oil-proof IP65\*, and waterproof structure equivalent to the NEMA4 standard\*.
- \* The panel may not be usable in environments where it is exposed to oil for long periods.

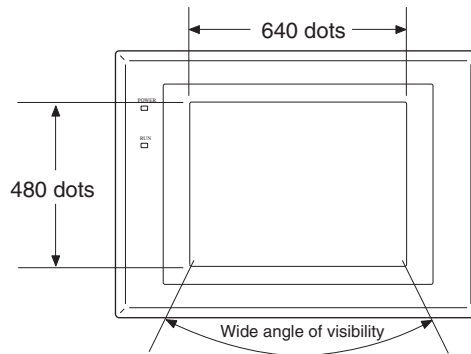

#### Touch Switch Operation

Contrast and brightness are adjustable by touch switch operations (for NT631C-ST141□-EV2 only).

#### Compatibility with Other PTs

- There is upward compatibility between the NT631/NT631C and the following models for screen data and user programs: NT11S, NT20S, NT30, NT30C, NT31, NT31 NT600S, NT610G, NT610C, NT620S, NT620C, NT625C. (After being read to the Support Tool, screens must be modified in accordance with the screen size. Depending on the function used, partial modification of programs may also be necessary. For details on the compatibility of screen data, refer to the *NT31/NT31C/NT631/NT631C Programmable Terminal Reference Manual* and the *NT-series Support Tool Operation Manual*.)
- The dimensions of the panel cut-out to accommodate the NT631/NT631C are the same as for the NT625C.

|   |   |
|---|---|
| <b>Two Ports Featured as Standard:</b>  | <b><u>Port A for Common Use by Support Tool/Host and Port B for Exclusive Use by the Host</u></b>   |
|   | <ul style="list-style-type: none"> <li>• Communications with the host is possible via another port while connected to the Support Tool.</li> <li>• Reading bar code data from a bar code reader is possible via another port while communicating with the host.</li> </ul>  |
| <b>Rapid System Program &amp; Screen Data Changes Possible Using a Memory Unit.</b> | <ul style="list-style-type: none"> <li>• Installing a Memory Unit (type NT-MF261) on the rear of the NT631/NT631C makes it easy to write screen data into the NT631/NT631C on site. This enables a rapid response to setup changes.</li> <li>• NT631/NT631C can store a system program into a Memory Unit. This enables the system to handle more flexible setups.</li> </ul> |
| <b>Screen Data Check Function</b>   | Screen data can be checked simply by operations at the NT631/NT631C system menu, without connecting up to the Support Tool.   |
| <b>Large Increase in Maximum Number of Registered Elements</b>                      | The number of elements that can be registered on one screen has been considerably increased, making it possible to create more expressive screens. For details, refer to <i>Display Restrictions</i> in <i>Appendix A Specifications</i> of the <i>NT31/NT31C/NT631/NT631C Programmable Terminal Reference Manual</i> .   |
| <b>Binary Data can be Read to/Written from the Host</b>                             | It is now possible to write binary data stored in words at the host directly to the NT631/NT631C. This makes data conversion by a program at the host unnecessary, reducing the load on the host.   |
| <b>Character Display Using High Definition Fonts</b>                                | Any quadrupled characters are displayed with a 32 dot high-definition font.   |
| <b>Simple Version Upgrades</b>  | By using the system installer supplied with the Support Tool (Type NT-ZJCAT1-EV4), the system program at the NT631/NT631C can be changed easily from a personal computer.   |
| <b>Complies with International Standards</b>  | The NT631/NT631C meets UL/CSA standards and EC directives.  |
| <b>Compatible with Other Vendors' Devices</b>                                       | Compatible with Sequencers in the following series: Mitsubishi A-series (Calculator Link) and FX-series (Programming Console), Allen-Bradley SLC 500 Series, GE Fanuc 90-20 and 90-30 Series, and Siemens S7-300 and S7-400 Series. Specialized system programs can be installed that allow the NT631/NT631C to be controlled from other companies' Sequencers.               |
| <b>Multiple Windows</b>   | Up to 3 windows can be displayed simultaneously in the normal screen. A 9-word window control area has been allocated to the host; the contents of these 9 words can be changed from the Host to open, close, and move windows.   |
| <b>High-speed 1:N NT Link</b>   | The V2 versions are compatible with the high-speed 1:N NT Link as well as the earlier standard 1:N NT Link.   |
| <b>Additional Mathematical Functions</b>  | Operands (values referenced by formula) can be registered to allow the PT to perform calculations automatically and write the results of those calculations to numeral memory tables or words in the host.  |

|  |   |
|--|---|
| <b>Device Monitor Function</b>                               | The new device monitor function can be used to change the PLC's operating mode or display/change values in the PLC's memory areas. The present values (PVs) of several words can be listed with the device monitor.   |
| <b>Interlock Function</b>                                    | PT operations and inputs can be disabled from the PLC if interlock bits have been allocated in the PLC for the corresponding PT touch switches, numeric inputs, or string inputs.   |
| <b>Improved Lamp/Touch Switch Labels</b>                     | <p>The following displays can be performed with lamp or touch switch labels:</p> <ul style="list-style-type: none"> <li>• Display several lines of labels.</li> <li>• Switch the display between different labels when OFF and ON.</li> <li>• Display the numeral memory table contents as labels.</li> <li>• Display the string memory table contents as labels.</li> </ul>  |
| <b>NT30/NT30C and NT620S/NT620C/NT625C Emulation</b>         | <p>The word configuration of the PT status control area and PT status notify area can be set to emulate those of the NT30/NT30C or NT620S/NT620C/NT625C; this mode is called NT30/620 compatible mode.</p> <p>When the PT is operating in NT30/620 compatible mode, it will be equivalent to an NT30/NT30C or NT620S/NT620C/NT625C in the functions listed below. The PT retains full V2 functionality in all functions other than the ones listed below. Refer to <i>Appendix C</i> in the <i>NT31/NT31C/NT631/NT631C Programmable Terminal Reference Manual</i> for more details.</p> <ul style="list-style-type: none"> <li>• Word configuration and functions of the PT status control area and PT status notify area</li> <li>• Image/library codes</li> <li>• Insertion of image/library data into character strings</li> </ul> |
| <b>Additional CS/CJ-series Data Areas Accessible</b>         | <p>Data areas in CS/CJ-series PLCs that were previously inaccessible can be accessed. The data areas listed below can be accessed (read/written).</p> <p>All banks in the EM area, timer completion flags (TU), counter completion flags (CU), Work areas (WR), Task flags (TK), and the HR area.</p>   |
| <b>Recipe Function</b>                                       | You can set the data (numeric values) for multiple words in record units using the tabular elements on the PT screen, and write these settings in a single operation to words on the host (i.e., PLC or PT memory) using a touch switch operation on the PT Unit. Also, multiple words of numeric data can be read from the host in one operation. In this way, groups of parameter settings can be edited at the PT Unit, and written to or read from the host.  |
| <b>Adjusting Contrast and Brightness During PT Operation</b> | You can display the brightness and contrast adjustment screen using either the touch switch or commands from the host, even while the PT is in operation.   |



### 1-2-2 Comparison between NT631 and NT631C

Two NT631 models — the NT631, which is capable of versatile graphic displays (EL display, yellow), and the NT631C, which is also capable of color display — are available. The differences between the NT631 and NT631C are tabled below:

| Function      | NT631-ST211□-EV2                                    | NT631C-ST141□-EV2                                     | NT631C-ST153□-EV3                                     |
|---------------|---|---|---|
| Type          | NT631-ST211-EV2 (Beige)<br>NT631-ST211B-EV2 (Black) | NT631C-ST141-EV2 (Beige)<br>NT631C-ST141B-EV2 (Black) | NT631C-ST153-EV3 (Beige)<br>NT631C-ST153B-EV3 (Black) |
| Display panel | Monochrome EL display                               | STN color LCD display<br>(with white backlight)       | TFT color LCD display<br>(with white backlight)       |

Beige and black are the front panel colors of each NT631/NT631C types.

### 1-2-3 Comparison between NT620S/NT620C/NT625C and NT631/NT631C

| Item   |                | NT620S/NT620C/NT625C   | NT631/NT631C  |
|--|----------------|--|---|
| Support Tool used  |                | NT-ZJCAT1-EV4 or NT-ZA3AT-EV2  | NT-ZJCAT1-EV4   |
| DIP switches   |                | On rear of PT  | None (software settings)  |
| Use of Memory Unit   |                | Not possible   | Possible  |
| RS-232C interface  |                | Connector (9-pin) also used as port for screen data transfer.  | - Serial port A connector (also used for screen data transfer, 9-pin)<br>- Serial port B connector (for host communications only, 9-pin)                  |
| RS-422A/485 interface  |                | NT620S/NT620C: None<br>NT625C: Terminal block (DIP-switch selectable between RS232C and RS-422A/485) | Terminal block (serial port B; memory-switch selectable between RS232C and RS-422A/485)   |
| Replacement backlight  |                | NT620C-CFL01 (NT620C)<br>NT610C-CFL02 (NT625C)   | NT631C-CFL01 (for ST151; the backlight for the NT631C-ST152□-EV2, NT631C-ST153□-EV3, however, cannot be replaced by the user)<br>NT631C-CFL02 (for ST141) |
| NT631/NT631C system program data   |                | NT620-ZS3AT-EV1/EMV1 (including system installer)  | The system installer and system program data are supplied with the Support Tool.  |
| High-speed 1:N NT Link   |                | Not possible   | Possible  |
| Memory Link  | System program | Exclusive use by Memory Link   | Same as OMRON connection  |
|  | Screen data    | Shared with OMRON connection   | Exclusive use by Memory Link  |
| LCD contrast adjustment  |                | By a control on the rear of the PT   | By touch panel operation (Possible in the NT631-ST141□-V2 only.)  |
| Backlight brightness adjustment  |                | Not possible   | By touch panel operation (Possible in the NT631-ST141□-V2 only.)  |
| Number of user-registered screens  |                | Maximum of 2000  | Maximum of 3999   |
| Screen data capacity*1 (User program memory)                                       |                | NT620S: 512 KB<br>NT620C/NT625C: 1 MB  | 1 MB  |
| Numeral string data  |                | Maximum of 1000  | Maximum of 2000   |
| Character string data  |                | Maximum of 1000  | Maximum of 2000   |
| Bit data   |                | 256  | Maximum of 1000   |
| Mathematical tables  |                | None   | 256 max.<br>Calculations can be executed automatically in the PT.   |
| Image data   |                | Maximum of 224   | Maximum of 4095*2   |
| Library data   |                | Maximum of 896   | Maximum of 12288*2  |
| Method for storing numeric values (numeral memory data and PT status control area) |                | Fixed as BCD (binary coded decimal)  | Selectable from BCD (binary coded decimal) or binary  |
| PT status control area size  |                | 4 words  | 5 words (partial change of contents)*2  |
| PT status notify area size   |                | 3 words  | 2 words (partial change of contents)*2  |
| Window control area size   |                | None   | 9 CH  |
| Registering continuous screen  |                | Possible   | Not possible (Use a screen switchover as a substitute.)   |
| Lamp/Touch switch labels   |                | Fixed display (1 line only)  | - Multiple lines can be displayed<br>- ON/OFF switching is possible<br>- Numeral display is possible<br>- Character string display is possible            |

| Item                                   | NT620S/NT620C/NT625C | NT631/NT631C  |
|--|----------------------|---|
| Interlock function                     | None                 | Operations can be disabled from the PLC by allocating interlock bits to the corresponding touch switch, numeral input, or character string input.   |
| Device monitor function                | Not possible         | Possible  |
| Recipe function                        | None                 | Possible  |
| Accessible CS/CJ-series PLC data areas | ---                  | The data areas listed below can be accessed in addition to the data areas accessible with the NT30/NT30C.<br>- EM banks (EM_0 to EM_C)<br>- Timer completion flags (TU)<br>- Counter completion flags (CU)<br>- Work areas (WR)<br>- Task flags (TK)<br>- HR area |

\*1 This is the capacity of the flash memory that stores screen data.

\*2 The values are the same as the NT30/NT30C when the PT is in NT30/620 compatible mode.

For differences in programming, refer to *Appendix B* in the *NT31/NT31C/NT631/NT631C Programmable Terminal Reference Manual*.

### 1-2-4 Principal Functions of NT631/NT631C

The following are the principal functions of the NT631/NT631C.

**Functions relating to data display**

**Character display**

Characters of various sizes can be displayed. Characters can be flashed and displayed in reverse video. High grade fonts are available for the characters with their size enlarged.

**Graphic display**

Polylines, rectangles, polygons, circles, circular arcs, and sector shapes can be displayed. They can also be tiled with various patterns, flashed, or displayed in reverse video.

**Memory data display**

The contents of character string memory tables and numeral memory tables can be displayed. The contents of memory tables can be changed from the host.

**Graph display**

Not only bar graphs but also broken line graphs, trend graphs, and analogue meter graphs can be displayed using numeral memory tables

**Lamp display**

Lamps can be turned on and flashed under the control of the host. It is also possible to display different graphics in the ON and OFF states.

**Alarm list/history display**

Warning messages are automatically displayed in a list in response to the state of a host bit. The time and the number of times of the messages appeared can also be displayed.

**Functions relating to data output**

**Buzzer**

A built-in buzzer can be sounded.

**Screen printing**

A hard copy of the currently displayed screen can be printed at the printer connected to the NT631/NT631C.

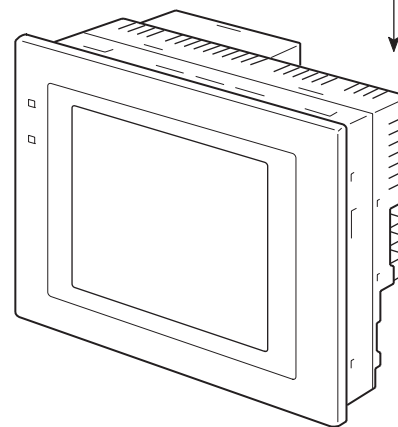

**Functions relating to data input**

**Input by touch switches**

Data can be input by simply touching touch switches displayed on the screen. The possible functions of touch switches include sending data to the host and changing the screen display. Inputs can be enabled and disabled from the host when interlock bits have been allocated.

**Pop-up window function**

A window overlaying the currently displayed screen can be alternately opened and closed by pressing a touch switch. In addition to fixed character and graphic displays, control keys and character keys created as touch switches can also be set inside the window. A maximum of three windows can be displayed simultaneously. Since the window need only be opened when input is required, the screen can be used efficiently.

**Numeral/character string setting function**

Numeric keys and character keys can be assigned to touch switches so that numeric values and character strings can be input at the operation site. The input data is written to numeral/character string memory tables and also sent to the host. It is also possible to disable input by control from the host.

**Recipe function**

Several words of numeric data can be edited at the PT Unit, and written to or read from the host in one operation.

**Input from a bar code reader**

Data read with a bar code reader can be input to a character string input field.

**Functions relating to communications**

**Communications with the host**

The NT631/NT631C can communicate with the host by four methods: host link, 1:1 NT link, 1:N NT link (standard or high-speed), and Memory link. Data can be read from the host, and data input by means of touch switches and numeral/character string settings can be sent to the host. It is also possible to connect with other model PCs.

**Functions relating to the system**

**System menu**

System settings and maintenance can be performed by selecting from system menus displayed on the screen.

**Creation of screen data**

Screen data created using the Support Tool at a personal computer can be transferred and stored in the built-in screen data memory.

**Resume function**

The status and memory table contents of the NT631/NT631C immediately before its operation is stopped can be stored while operation is stopped, or while the power is off, and then displayed on the screen again when operation is restarted.

**Screen saver function**

This function serves to extend the service life of the backlight and EL and prevent the formation of an afterimage on the screen.

**Clock function**

The time can be displayed in accordance with the internal clock data.

**Programming Console function**

When the NT631/NT631C is connected to a C-series CPM1, CPM2A, CPM2C, CQM1, CQM1H, or C200HX/HG/HE(-Z)/E Programmable Controller in an NT link (1:1) connection, or is connected to CS/CJ-series in an NT link (1:N) connection, operations equivalent to those of a Programming Console (C200H-PR027-E) are possible.

**Device Monitor function**

When the PT is connected to a PLC in a 1:1 NT Link or 1:N NT Link, the PT can be used for operations such as changing the PLC's operating mode, displaying or changing the PVs of words, or reading the error log.

**System program install function**

The system program of the NT631/NT631C can be changed by using the system installer supplied with the Support Tool (NT-ZJ3AT1/ZJCAT-EV2). It can also be installed by using a memory unit (NT-MF261).

**Screen display history function/alarm history function**

The screen display history function records the time at which specific screens are displayed and the number of times they are displayed. The alarm history function records the time at which specific bits at the host are turned ON and the number of times they are turned ON.

**Trend graph logging function and background function**

Changes in the contents of numeral memory tables displayed in trend graphs can be recorded (logging function). Also, the record can be maintained even when the trend graph is not displayed (background function).

**Mathematical function**

This function allows calculations to be executed continuously during PT operation when mathematical table have been set in screen data. Arithmetic operations, bit operations, logic operations, and comparison operations can be performed. Operations with up to 5 terms are possible.

### 1-2-5 Displays

The NT631/NT631C can display various kinds of elements such as characters, numeric values, graphs, lamps, and touch switches, on a screen. The screen data displayed by the NT631/NT631C are created by using the Support Tool at a personal computer.

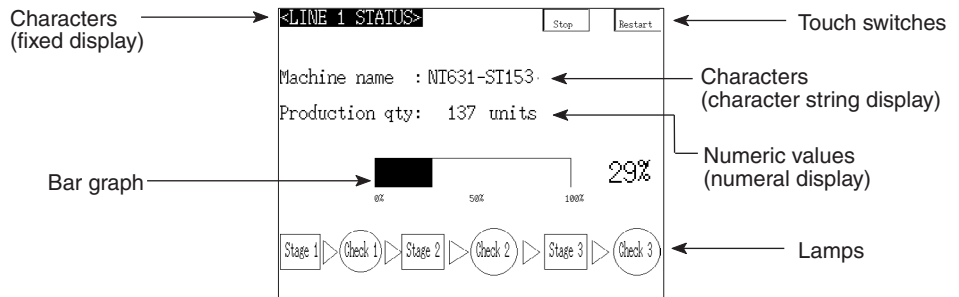

#### Fixed Displays

Characters and various graphics (circles, circular arcs, sectors, polylines, polygons and rectangles) whose display does not have to be changed, and mark data, image data, and library data that has already been registered, can be written directly onto the screen.

Circle

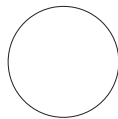

Arc

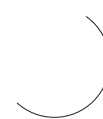

Sector



Polyline

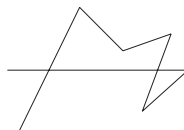

Polygon

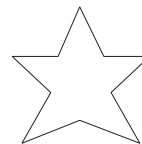

Rectangle



\* A continuous straight line with up to 256 points can be drawn.

\* A polygon with up to 255 vertices can be drawn.

Marks are graphics comprising 16 by 16 dots that can be used as characters. They can be used as custom characters within character strings.

Image data are graphics comprising any required area of dots. They are registered in advance and as many as required can be displayed at any position on the screen.

Windows bit map (BMP) data can be used for images.

There is a two-color mode, in which the display color and background color of the image are specified when it is registered in a screen, and an eight-color mode in which colors are assigned to the image in advance.

Since image data is composed of dots, it requires a large data size but offers great powers of expression.

Library data are combinations of fixed display graphics registered as a single graphic. They are registered in advance and as many as required can be displayed at any position on the screen.

Since it is generated by combining graphics, library data has a small data size.

Mark



Image data



Library data



**Lamps**

These are graphics whose display status changes in accordance with the states of bits at the host. Squares, circles, sectors and polygons can be used for lamps (normal (standard) lamps). In accordance with the status of the host bit, they can be lit (displayed in reverse video) or flashed (repeated alternation between normal and reverse video display states).

Lamps can also display different image/library data for the ON and OFF states of the host bit (such lamps are called image/library lamps).

There are four standard lamp labels: fixed display character strings, ON/OFF switching character strings, numeral displays, and character string displays. When fixed display character strings or ON/OFF switching character strings are used, several lines of labels can be displayed.

**Normal (Standard) Lamps**

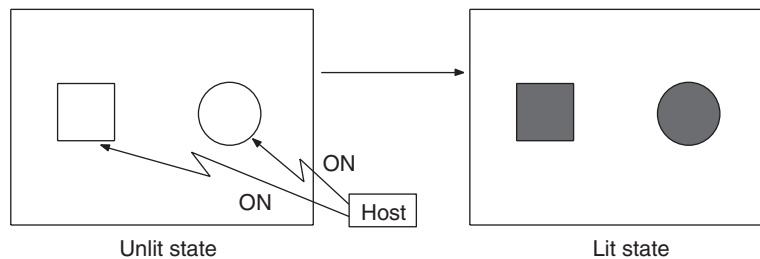

**Image/Library Lamps**

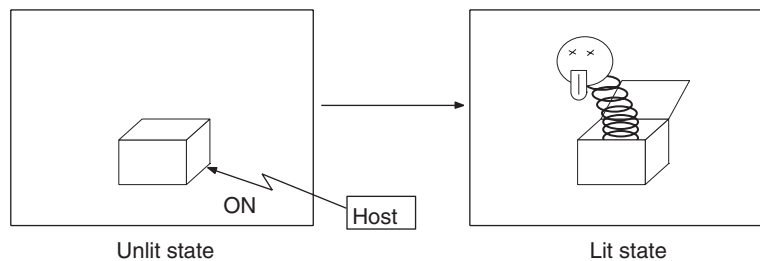

**Touch Switches**

These switches can be set at any location on the screen. Pressing a touch switch on the screen where a touch switch has been set can have the following effects:

- Notification to a host bit (input notification function)
- Changing the displayed screen (screen switching function)
- Input of a numeric value or character string (input key function)
- Copying of a numeric value or character string (copy key function)
- Shifting to another numeric value or character string input field (cursor moving key function)
- Obtaining a hard copy of the screen (screen print function)
- Opening / Closing a window
- Moving a window

Touch switches can be made to light or flash in accordance with the status of a host bit in the same way as lamps.

The following 8 types of display graphic can be used for touch switches:

Standard, shadow, 3-dimension, no display frame, rectangle, circle, polygon, sector

When rectangle, circle, polygon, or sector is selected as the shape, the area within which pressing of the touch switch is sensed (the touch switch area) can be set independently of the position where the display graphic is set.

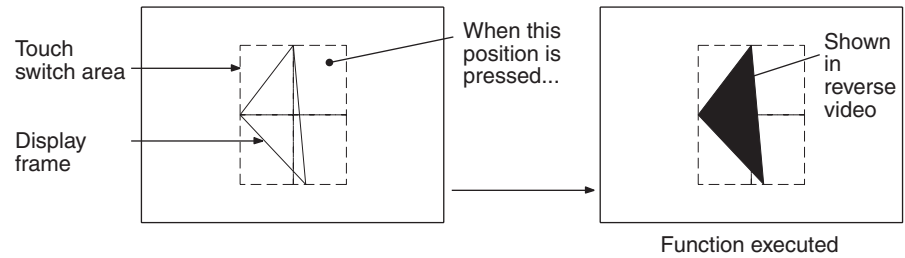

There are four touch-switch labels: fixed display character strings, ON/OFF switching character strings, numeral displays, and character string displays. When fixed display character strings or ON/OFF switching character strings are used, several lines of labels can be displayed.

**Numeral Display**

Numeric values stored in the numeral memory tables are displayed. The displayed numerals can be changed by changing the data stored in the numeral memory tables.

Hexadecimal values can also be displayed.

When decimal values are displayed, the number of digits for the integral part and fractional part of displayed values can be specified in advance.

**String Display**

Character strings stored in the character string memory tables are displayed. The displayed character strings can be changed by changing the data stored in the character string memory tables.

**Numeral Input**

Numeric values can be input at the PT by using touch switches. The input numeric values can also be stored in a numeral memory table and notification sent to the host.

Numeral inputs can be enabled and disabled from the host when an interlock bit has been allocated.

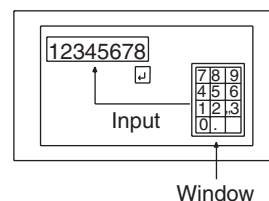

**String Input**

Character strings can be input at the PT by using touch switches, bar code readers, etc. The input character strings can also be stored in a character string memory table and notification sent to the host.

String inputs can be enabled and disabled from the host when an interlock bit has been allocated.

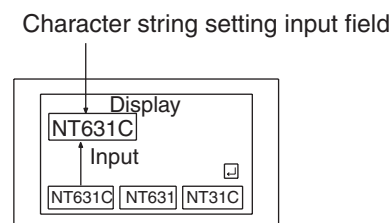



**Thumbwheel Switches**

Numeric values can be input by incrementing or decrementing each digit with the corresponding touch switch (+, -). The input numeric values can also be stored in a numeral memory table and notification sent to the host.

Thumbwheel switch inputs can be enabled and disabled from the host when an interlock bit has been allocated.

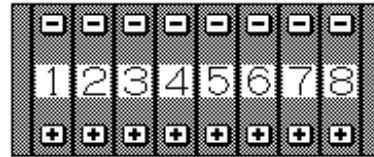

**Graphs**

These are graphics whose display changes in accordance with the numeric values stored in numeral memory tables. There are the following four types.

**Bar graphs:**

Bar graphs display the present value in a numeral memory table converted to a percentage within the range -100% to +100% of a preset value.



**Analogue meter:**

Analogue meters display, using a quarter, half, or full circle shape, the present value in a numeral memory table converted to a percentage within the range -100% to +100% of the preset value. Users can choose from moving pointer type and filling area type displays. Users can also add graduation to the graph.



**Broken line graphs:**

Broken line graphs display, in an easy-to-read form, a sequence of numeral memory table values converted to a percentage within the range -100% to +100% of a preset value.

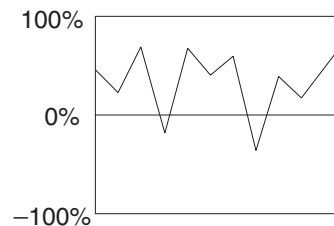

Example showing a series of 11 numeral memory table values (with a check mark set for the display sign)

**Trend graphs:**

Trend graphs display chronological changes in the value in a numeral memory table, converting the value to a percentage within the range -100% to +100% of a preset value. The trend graph shifts position with the passage of time.

Past data can also be recorded, and the numeral memory table can be read (sampled) even while the trend graph is not being displayed.

The user can choose to stop sampling, restart sampling, or display past data, by pressing touch switches.

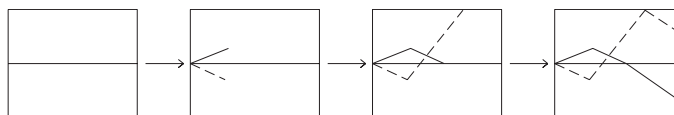

**Alarm List/History**

The alarm list/history function displays messages in list form, or graphics (image/library data), in accordance with changes in bit memory table statuses.

For the alarm list, a series of bit memory tables are monitored, and messages (contents of character string memory tables) set for bit memory tables that come ON are displayed.

For the alarm history, bit memory tables for which the history property is set are continually monitored, and the time when they come ON and number of times they come ON are recorded and displayed together with the message (character string) set for the bit memory table.

The NT631/NT631C allows selection of the display order as the newest record first or the oldest record first by memory switch setting.

The alarm list function is used to determine which bits are ON at the present time. The alarm history function is used to determine the times at which alarms occurred in the past and how many times alarms have occurred

**Alarm List**

Message (character string table No. 32)  
set for bit memory table No. 14

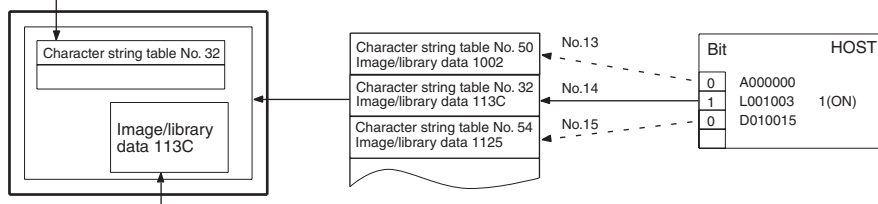

When the message displayed is pressed, the image/library data (113C) set for bit memory table No. 14 is displayed.

**Alarm History**

Message (character string table No. 13)  
set for bit memory table No. 24

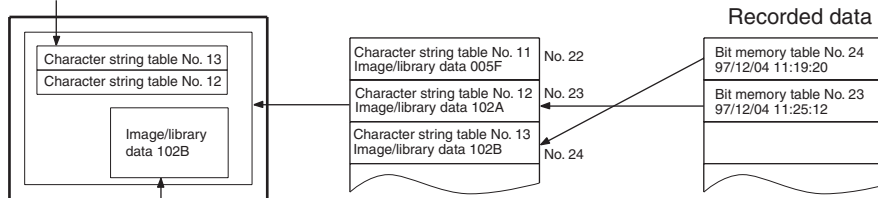

When the upper message displayed is pressed, the image/library data (102B) set for bit memory table No. 13 is displayed.

**Recipe**

You can set several words of numeric data at the PT in tabular format, and write it to the host. You can also read several words of numeric data from the host and display it on the PT screen.

**1-3 System Configuration**

This section shows the configuration of a system that uses an NT631/NT631C. For details on product models, refer to *Appendix J Model List* (page 281).

### 1-3-1 Peripheral Devices That Can Be Connected

The following peripheral devices can be connected to an NT631/NT631C.

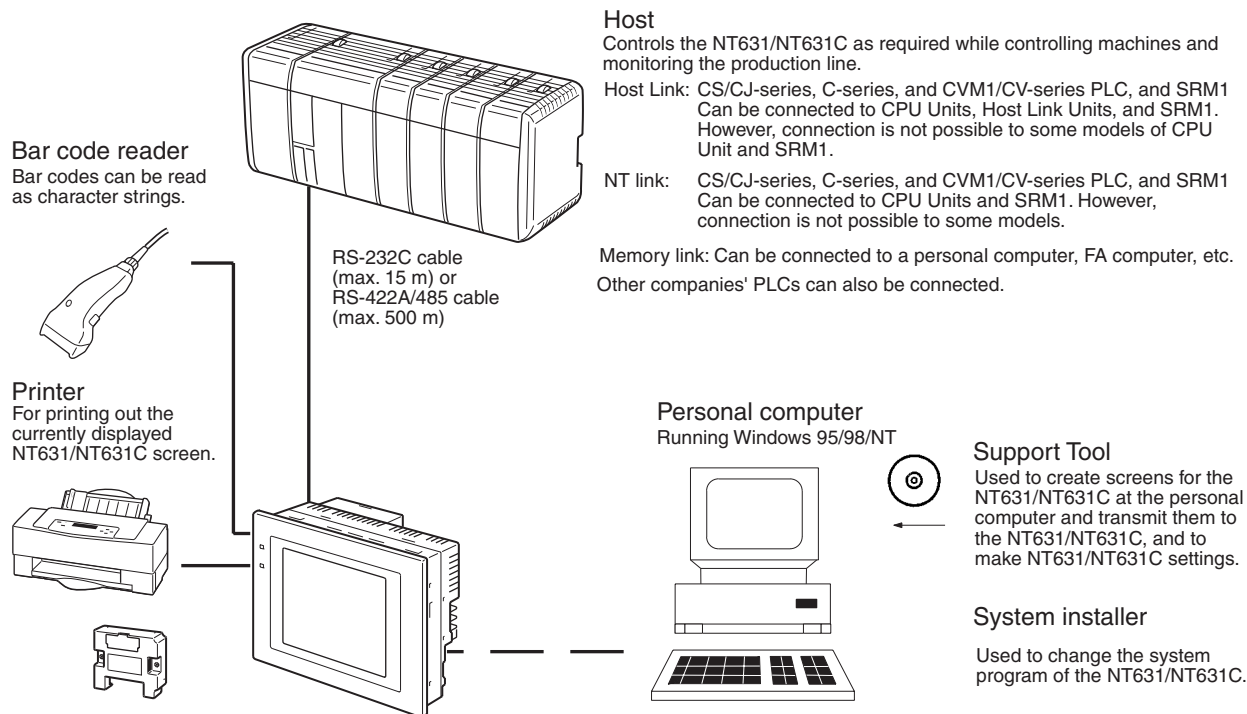

- Bar code reader (page 36)
- Recommended printers (page 36)

It is also possible to use printers that can emulate an NEC PC-PR201H (using the NEC PC-PR201PL control protocol), and printers that comply with one of the following EPSON control standards: ESC/P 24-J83C (color), or ESC/P 24-J82 (monochrome).

- Memory Unit (page 39)
  - NT-MF261 (made by OMRON)
- Support Tool (page 35)
  - NT-series Support Tool Version 4.□ for Windows (Made by OMRON)
    - NT-ZJCAT1-EV4 (CD-ROM version)
- System installer (page 35)
  - System installer (made by OMRON)

The system installer is supplied as a standard accessory with the Support Tool (NT-ZJCAT1-EV4).

**Reference:** The following optional devices are available. All of them can be used either with NT631 or NT631C.

|  |              |
|--|--------------|
| Anti-reflective Protective Sheet (5 pcs/set) | NT610C-KBA04 |
| Chemical-resistant Cover                     | NT625-KBA01  |
| Replacement Battery                          | 3G2A9-BAT08  |

## 1-3-2 Connecting to the Host

The NT631/NT631C has the following two communications ports.  
The serial port B is equipped with an RS-232C connector and an RS-422A/485 terminal block (selectable by memory switch).

### **Serial Port A:**

D-SUB 9-pin connector

For RS-232C use only (The Support Tool and bar code readers can be connected here.)

### **Serial Port B:**

D-SUB 9-pin connector for RS-232C use only (The Support Tool and bar code readers can be connected here) or Terminal block for RS-422A/485 use only.

The host can be connected at either of these two ports.

The connection methods for each communications method at the PT and host sides are indicated below. Make the settings in accordance with the communications method that can be used with the PLC to be connected and the conditions at the operation site.

**Reference:** When using an RS-232C/422A adapter (NT-AL001) with the host link or NT link (1:1) communications method, RS-485 cannot be used. The connection must be made with RS-232C or RS-422A.

## 1-4 Communications with the Host

The NT631/NT631C is connected to the host by one of the following communications methods.

The following communications can be used to connect an OMRON PLC:

- Host Link
- 1:1 NT Link
- 1:N NT Link (standard or high-speed)

The following communications can be used to connect another companies' PLC or FA computer:

- Communications protocol supported by the other company's PLC
- Memory link

In all of these communications methods that can be used with NT631/NT631C, data communications with host are by direct connection (Memory link is, however, a quasi-direct connection).

In the following, the host link and NT link that carry out the direct connection will be discussed. Memory link will be explained in *1-5 Communications Using Memory Links*.

### 1-4-1 Direct Connection Function

With the NT631/NT631C, the bits and words referring to data required for display, and those for storing input data, can be allocated to any part of the PLC memory area.

The NT631/NT631C can directly write to and read from such allocated bits and words to change the display status of the elements on the PT screen, control the PT operating status, and notify the host of the status.

This function, which directly reads and writes the statuses of words and bits without using a PLC program is called the direct connection function.

The words and bits allocated for direct connection are called the allocated words and allocated bits.

The direct connection function allows the data to be displayed at the NT631/NT631C to be read from the memory area in the PLC and written to memory tables in the NT631/NT631C. Also, the data input at the NT631/NT631C can be written to the memory area in the PLC. The NT631/NT631C screen can be changed in accordance with statuses in the PLC memory area, and the NT631/NT631C's status data can be written to the PLC's memory area.

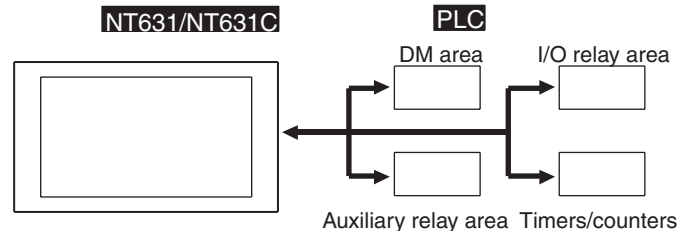

**Features of the Direct Connection Function**

The direct connection function has the following features.

- The bits and words referring to operating status and work instruction information and those for storing input data can be freely allocated to almost any area of the PLC memory.
- Since the NT631/NT631C can directly refer to PLC bit and word data without using the program at the PLC, it can be connected to the PLC without changing the PLC program which controls the currently running production line.
- The area to control and provide notification of the NT631/NT631C status, including display screens, display/no display status, and buzzer output, can be freely allocated to any part of the PLC data area. This means that the PLC status can be read and controlled just by reading this area at the PLC side, without preparing a special communications program.

The direct connection function allows the NT631/NT631C to directly read and write almost all bits and words in the PLC and to automatically change the NT631/NT631C screen display. This function can reduce the load on the PLC so that its program development efficiency is improved.

**1-4-2 Host Link**

The host is connected to a PT in a 1:1 connection, and the words and bits of the host are read and displayed by host link communications. This method can be used for connection to the majority of PLC types.

**1-4-3 NT Link**

NT link is a method for high-speed communications with a PLC using the direct connection function. The PLCs that can be connected with the NT link are as follows.

CPM1, CPM2A, CPM2C, CQM1, CQM1H, C200HS, C200HX/HG/HE(-Z)E, CS1G/CS1H-E(V1), CS1D, CJ1G/CJ1H/CJ1M, CVM1/CV-series PLC (-EV1 or later version), SRM1

Besides the 1:1 NT link method, in which one PLC is connected to one PT, the NT631/NT631C can also use the 1:N connection NT link method, which allows a maximum of eight PTs to be connected to one PLC port.

PLCs that can be connected with the 1:N connection NT Link method are as follows: CQM1H, C200HX/HG/HE(-Z)E, CS1G/CS1H-E(V1), CS1D, CJ1G/CJ1H/CJ1M.

The NT631/NT631C also supports OMRON's high-speed 1:N NT Link that provides faster 1:N communications. The only PLCs that support the high-speed 1:N NT Link are CS1G/CS1H PLCs of version -EV1 and higher, CS1D PLCs, and CJ1G/CJ1H/CJ1M PLCs.

In the following sections, the term NT Link is used to refer to the NT Link communications method in general, the term 1:1 NT Link is used to refer specifically to NT Links with a 1:1 connection, and the term 1:N NT Link is used to refer to both standard and high speed NT Links with 1:N connections. When necessary, the standard 1:N NT Link is distinguished from the high-speed 1:N NT Link.

### Features of the NT Link

The NT link has the following features.

- High-speed communications with specific types of PLCs can be executed. The NT631/NT631C also supports OMRON's high-speed 1:N NT Link.
- Writing in units of bits to the PLC memory area is possible.  
This enables the other bits of words to which a touch switch has been allocated to be allocated for other purposes (e.g. a lamp).  
However, since data is written to the DM area in word units, the other bits of words allocated to touch switches in this area cannot be used for other purposes.
- The NT link can be used even when the PLC is in the RUN mode. (When the host link method is used, the NT631/NT631C switches to the monitor mode when the PLC is in the RUN mode.)
- In the case of PTs that support the standard 1:N NT Link (NT20S, NT31, NT31C, NT600S, NT620S, NT620C, NT625C, NT631, NT631C) up to 8 PTs can be connected to one port of the PLC and used at the same time. Up to 8 PTs (NT31, NT31C, NT631, and NT631C) can also be connected simultaneously when the high-speed 1:N NT Link is being used. All of the PTs connected to a PLC port must use either the standard or high-speed 1:N NT Link; the two communications systems cannot share a single port.
- When using a C200HX/HG/HE(-Z)E PLC and standard 1:N NT Links, up to three 1:N NT Link systems (i.e., 24 PTs) can be connected by installing a Communications Board in the option slot of the CPU Unit. (Only the standard 1:N NT Link can be used.) For details on the Communications Board, refer to the *SYSMAC Communications Board Operation Manual* (W304-E1-□).
- When using a CQM1H PLC and standard 1:N NT Links, multiple 1:N NT Link systems can be connected by installing Serial Communications Boards in the Inner Board slots. For details on the Serial Communications Board, refer to the *CQM1H Serial Communications Board Operation Manual* (W365-E1-□).
- Multiple 1:N NT Link systems (standard or high-speed) can be connected by installing a Communications Board in the Inner Board slot of the CPU Unit for a CS1G/H/D PLC or installing a Serial Communications Unit on the Backplane for a CS1G/H/D or a CJ1G/M/H PLC. For details on the Communications Board/Communications Unit, refer to the *CS/CJ-series Serial Communications Board/Unit Operation Manual* (W336-E1-□).
- If the PLC supports the Programming Console function, the NT631/NT631C can be used as a Programming Console.
- If the PLC supports the Device Monitor function, the NT631/NT631C can be used to change the PLC's operating mode and read/change data in the PLC's memory areas.

The NT link is compatible with the host link. The NT631/NT631C screen data and PLC programs used with the host link direct connection method can be used with the NT link method as they are.

### 1-4-4 Connecting to Other Companies' PLCs

Installing a system program for multi-vendors by using a specific system installer enables the NT631/NT631C to be connected to the PLCs of other models in direct connection. This system installer is supplied with the Support Tool (NT-ZJCAT1-EV4).

#### Compatible PLC

The NT631/NT631C can be connected to the following model PLCs.

- Mitsubishi A-series programmable controller (computer link module)
- Mitsubishi FX-series programmable controller
- SLC 500 Series by Allen-Bradley
- 90-20 and 90-30 Series by GE Fanuc
- S7-300 and S7-400 Series by Siemens

For details on the procedure for connecting to other model PLCs, refer to the *PLC Connection Manual* or *NT31/631 Multi Vendor Connection Manual*.

## 1-5 Communications Using Memory Links

In this section, a communications method other than the direct connection, called the memory link, is discussed.

### 1-5-1 Memory Link

Memory link is a method to send and receive data between a personal computer or a FA computer and the NT631/NT631C by using RS-232C/422A communications.

In memory link, there is an area called PT Memory, as shown below, inside the NT631/NT631C, and this area is treated as a virtual area on the PLC. This allows PT memory and the display elements of the NT631/NT631C to make a quasi-direct connection. By sending a command for the memory link, the host can make the NT631/NT631C execute processes through PT memory. Frequently used commands are kept handy for read and write tasks of the numeral memory table, character-string memory table, and bit memory table.

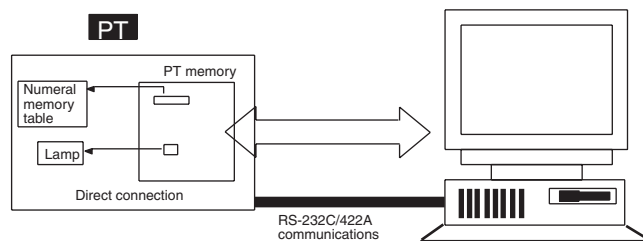

In the memory link method, the only difference is that the NT631/NT631C finds its communications target inside instead of outside. In the memory link method, therefore, change of the target is all that is needed to be capable of using the exact screen data that is acquired by the direct connection. (With the NT631/NT631C, the Support Tool must be used to convert the data to screen data for the memory link.)

When compared to the direct connection of the host link or NT link methods, the memory link method has some restrictions regarding the use of some functions, as described below.

- The Programming Console and Device Monitor functions cannot be used.
- The following strobes of PT status notify bits do not turn ON (pages 7 to 27).
  - Screen switching strobe
  - Numerals input strobe
  - Character-string input strobe
- The usable area for allocation is the PT memory only.

## 1-5-2 Comparison between Direct Connection and Memory Link

The major differences between the direct connection and the memory link are as follows:

- 1,2,3...**
1. In the memory link method, the communications with the host should be carried out by using commands. Compared to the ordinal direct connection, which can be used requiring almost no programs, the memory link method requires a program that is necessary for interchange of commands.  
This, however, gives advantages to the memory link method by using a large variety of functions available in the direct connections from major models such as a personal computer and a FA computer equipped with RS-232C/RS-422A communications means, allowing the PT to be suited for larger usage.
  2. Actual PLCs have many kinds of areas, where as PT memory is a single area with only one kind. When creating screen data by using the memory link methods, it is always necessary to allocate display parts in the PT memory.

For communications between the host and the PT by the memory link method and for handling screen display elements, refer to the *NT31/NT31C/NT631/NT631C Programmable Terminal Reference Manual*.

## 1-5-3 Memory Link Online Transfer Function

When memory link communications are being used, the NT631/NT631C can be switched to Transmit mode from the host even if the NT631/NT631C is operating and screen data can be written. (The NT631/NT631C can be returned to RUN mode after the screen data is written.)

The memory link online transfer function can be used to replace screen data at a fixed time each day or replace screen data with maintenance screen data for maintenance.

For more details on the memory link online transfer function, refer to information on the memory link online transfer function in the *NT31/NT31C/NT631/NT631C Programmable Terminal Reference Manual*.



# 1-6 Before Operating

Follow the procedure given below to start the system of the NT631/NT631C.

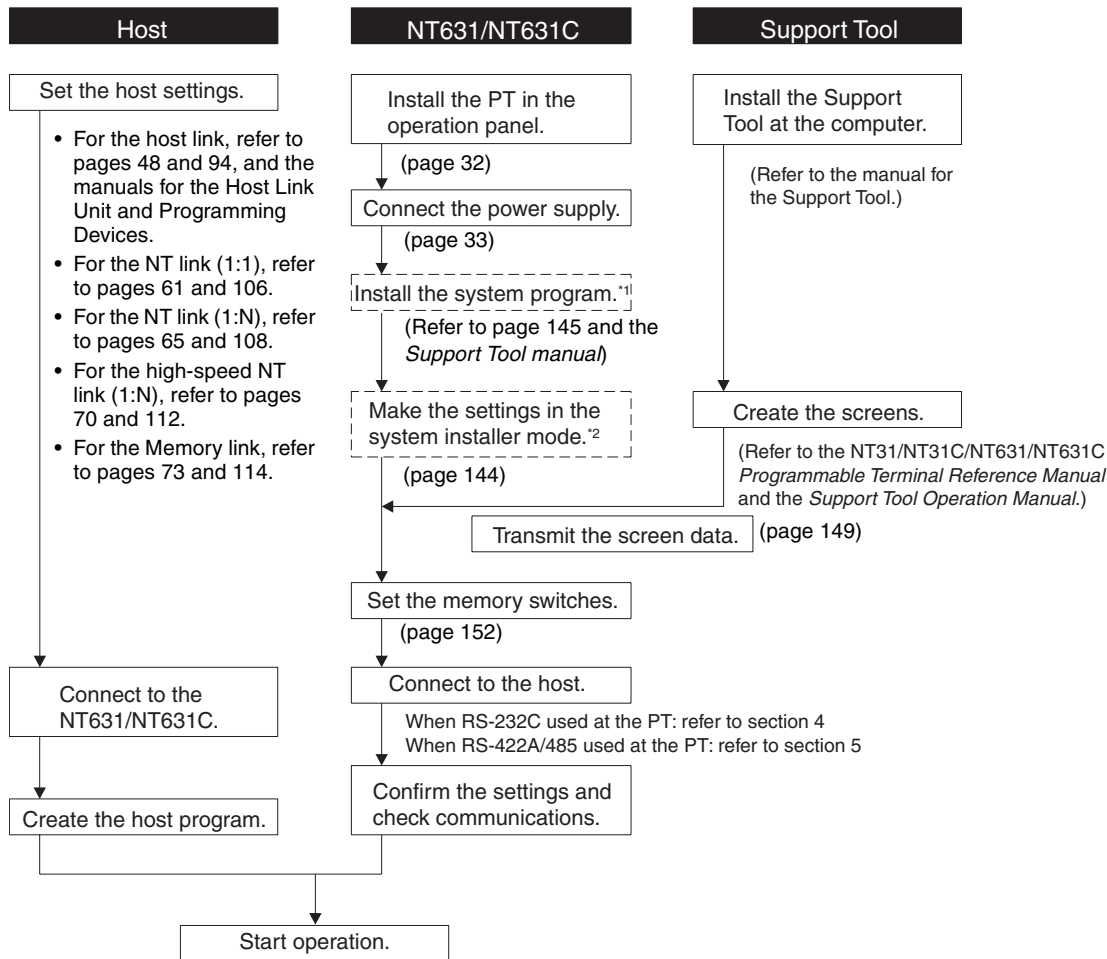

\*1 System program installation is only done in special circumstances, for example when changing the system program, or to recover the original status of the installed program. This operation is not normally necessary. When using other PLC models (sequencers), however, it is necessary to install specific system programs.

\*2 Display of the system menu, and all change operations, can be inhibited. This enables you to prevent the accidental deletion or alteration of screens and settings.

- Reference:**
- For the system program, use the NT631/NT631C system program supplied as an accessory with the NT-series Support Tool (NT-ZJCAT1-EV4).
  - For the Support Tool, use NT-series Support Tool for Windows (Ver. 4.□).

Refer to the following manuals for the devices and software.

| Device or Software       | Manual Title   | Manual Number |
|--------------------------|--|---------------|
| NT31/NT31C, NT631/NT631C | Reference Manual   | V064-E1-1     |
| System Installer         | NT-series Support Tool for Windows (Ver. 4.□) Operation Manual | V061-E1-□     |
| Support Tool             | NT-series Support Tool for Windows (Ver. 4.□) Operation Manual | V061-E1-□     |

| Device or Software   | Manual Title   | Manual Number          |
|--|--|------------------------|
| PLCs   | SYSMAC CPM1 Operation Manual   | W262-E1-□              |
|  | SYSMAC CPM1A Operation Manual  | W317-E1-□              |
|  | SYSMAC CPM2A Operation Manual  | W352-E1-□              |
|  | SYSMAC CPM1/CPM1A/CAM2A/CPM2C/SRM1(-V2) Programmable Controllers Programming Manual                  | W353-E1-□              |
|  | SYSMAC CPM2C Operation Manual  | W356-E1-□              |
|  | SYSMAC C200H Operation Manual (for CPU01/03/11) (programming)  | W130-E1-□              |
|  | SYSMAC C200H Operation Manual (for CPU21/23/31) (programming)  | W217-E1-□              |
|  | SYSMAC C200HS Installation Guide   | W236-E1-□              |
|  | SYSMAC C200HS Operation Manual (programming)   | W235-E1-□              |
|  | SYSMAC C200HX/HG/HE-ZE Installation Guide  | W302-E1-□              |
|  | SYSMAC C200HX/HG/HE Programming Manual   | W303-E1-□              |
|  | SYSMAC C200HX/HG/HE-Z Programming Manual   | W322-E1-□              |
|  | SYSMAC C1000H/C2000H Operation Manual (programming)  | W140-E1-□              |
|  | SYSMAC CQM1 Programming Manual   | W228-E1-□              |
|  | SYSMAC CQM1H Operation Manual  | W363-E1-□              |
|  | SYSMAC CVM1/CV500/CV1000/CV2000 Operation Manual: Ladder Diagrams                                    | W202-E1-□              |
|  | SYSMAC CS Series Programmable Controllers Operation Manual   | W339-E1-□              |
|  | SYSMAC CJ Series Programmable Controllers Operation Manual   | W393-E1-□              |
|  | SYSMAC CS Series, CJ Series, NSJ Series Programmable Controllers Programming Manual                  | W394-E1-□              |
|  | SYSMAC CS Series, CJ Series, NSJ Series Programmable Controllers Operation Manual                    | W340-E1-□              |
|  | SYSMAC CS/CJ Series Programming Consoles Operation Manual  | W341-E1-□              |
|  | SYSMAC CS/CJ/CP Series, NSJ Series Communications Commands Reference Manual                          | W342-E1-□              |
| SYSMAC CS/CJ Series Serial Communications Boards, Serial Communications Units Operation Manual | W336-E1-□  |                        |
| SYSMAC CQM1H Series Serial Communications Board Operation Manual                               | W365-E1-□  |                        |
| CompoBus Master Control Unit   | SRM1 Operation Manual  | W318-E1-□              |
| Programming Devices  | SYSMAC Support Software Operation Manual: C-series PLCs  | W248-E1-□              |
|  | SYSMAC Support Software Operation Manual: CVM1 PLCs  | W249-E1-□              |
|  | SYSMAC CPT User Manual and Quick Start Guide   | W332-E1-□<br>W333-E1-□ |
|  | CX-Programmer Operation Manual   | W446-E1-□              |
| Host Link Units and Serial Communications Boards   | SYSMAC C-series Host Link Unit Operation Manual  | W143-E1-□              |
|  | SYSMAC CVM1/CV-series Host Link Operation Manual   | W205-E1-□              |
|  | SYSMAC C200HW-COM01 C200HW-COM02-V1 to C200HW-COM06-EV1 Serial Communications Board Operation Manual | W304-E1-□              |

# SECTION 2

## Preparing for Connection

This section describes the connection methods that are possible with the PT, and the functions of the parts of PT, as the required knowledge before connecting to the host and to the peripheral devices.

- 2-1 Method for Connection to the Host ..... 26
- 2-2 Names and Functions of Parts ..... 29

## 2-1 Method for Connection to the Host

This section describes the methods for connection to the host used with the NT631/NT631C, and the relationship between the connection method and the communications method.

### **NT631/NT631C Communications Ports and Communications Methods**

The NT631/NT631C has two communications ports. Their uses are indicated in the table below.

| Communications Port |                | Usable Communications Methods   | Communications Type  |
|---------------------|----------------|---|--|
| Serial port A       |                | Host link<br>NT Link (1:1)<br>NT Link (1:N) (See note.)<br>Memory link<br>(Support Tool connection)<br>(bar code reader input function) | RS-232C  |
| Serial port B       | Connector      | Host link<br>NT Link (1:1)<br>NT Link (1:N) (See note.)<br>Memory link  | RS-232C<br>(select between connector and terminal block)     |
|                     | Terminal block | Host link<br>NT Link (1:1)<br>NT Link (1:N) (See note.)   | RS-422A/485<br>(select between connector and terminal block) |

**Note** There are two NT Link (1:N) communications rates: standard and high-speed.

### **Communications Methods That Can Be Used with the Host**

The following communications methods can be used with the hosts that can be connected to the NT631/NT631C.

- RS-232C
- RS-422A
- RS-485

The communications types that are actually supported differ depending on the host. For details, refer to *SECTION 4 Connecting to the Host from the RS-232C Port* and *SECTION 5 Connecting to the Host from the RS-422A/485 Port*.

### **Converting the Communications Type with an RS-232C/RS-422A Adapter**

The following communications type conversions are possible by using an RS-232C/RS-422A adapter (NT-AL001, made by OMRON).

- RS-232C ⇔ RS-422A
- RS-232C ⇔ RS-485

**Combinations of Communications Method and Connection Method**

The connection methods that can be used depending on the communications method used and the communications type for communications between the NT631/NT631C and the host are indicated in the table below.

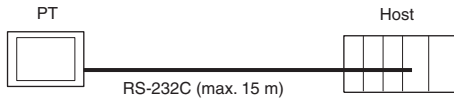
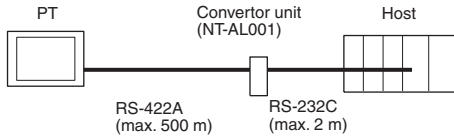
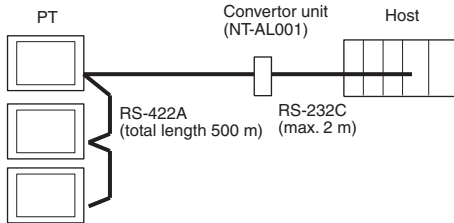
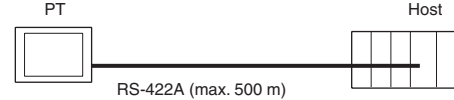
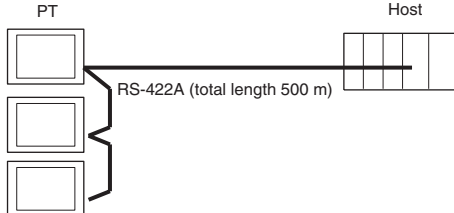
| Communications Type at PT | Communications Type at Host | Usable Connection Method  | Usable Communications Method |               |               |             | Details  |
|---------------------------|-----------------------------|---|------------------------------|---------------|---------------|-------------|----------|
|                           |                             |   | Host link                    | NT Link (1:1) | NT Link (1:N) | Memory link |          |
| RS-232C                   | RS-232C                     | Direct 1:1 connection<br>                | ○                            | ○             | ○             | ○           | page 73  |
| RS-422A                   | RS-232C                     | 1:1 connection via a convertor unit<br>  | ○                            | ○             | ○             | ○           | page 82  |
|                           |                             | 1:N connection via a convertor unit<br> | ×                            | ×             | ○             | ×           | page 86  |
|                           | RS-422A                     | Direct 1:1 connection<br>              | ○                            | ○             | ○             | ○           | page 115 |
|                           |                             | 1:N connection<br>                     | ×                            | ×             | ○             | ×           | page 119 |

○: Connection possible ×: Connection not possible

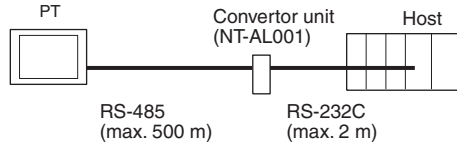
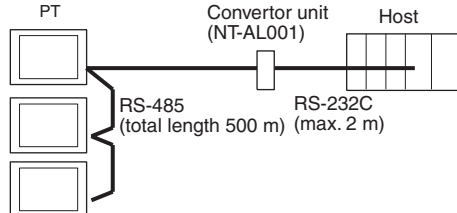
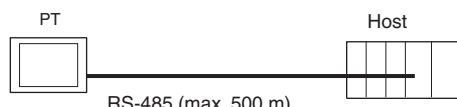
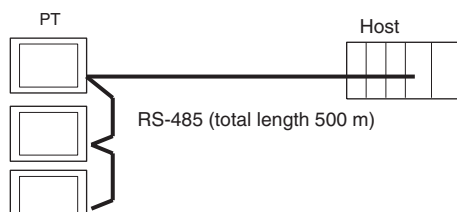
| Communications Type at PT | Communications Type at Host | Usable Connection Method   | Usable Communications Method |               |               |             | Details  |
|---------------------------|-----------------------------|--|------------------------------|---------------|---------------|-------------|----------|
|                           |                             |  | Host link                    | NT Link (1:1) | NT Link (1:N) | Memory link |          |
| RS-485                    | RS-232C                     | 1:1 connection via a convertor unit<br> | ×                            | ×             | ○             | ×           | page 82  |
|                           |                             | 1:N connection via a convertor unit<br> | ×                            | ×             | ○             | ×           | page 86  |
|                           | RS-485                      | Direct 1:1 connection<br>               | ×                            | ×             | ○             | ×           | page 118 |
|                           |                             | 1:N connection<br>                    | ×                            | ×             | ○             | ×           | page 121 |

○: Connection possible ×: Connection not possible

- The RS-232C/RS-422A adapter (NT-AL001) requires +5 V, 150 mA at pin 6 of the RS-232C connector. Check the signals of the RS-232C connector at the host.
- +5 V is not output from serial port B of the NT631/NT631C. When connecting an NT-AL001 at serial port B, a separate power supply is required for the NT-AL001.
- The cable of an NT-AL001 cannot be connected or disconnected while the power is ON. Always connect or disconnect the cable while the power supply from the RS-232C cable is OFF (while the host power supply is OFF).
- NT Link (1:N) connection is possible even when RS-232C is used at the NT631/NT631C side for communications with the host, but in this case one NT-AL001 Adapter is required for each NT631/NT631C. In this case, it is convenient to use serial port A of the NT631/NT631C. +5 V is not output from serial port B.

## 2-2 Names and Functions of Parts

Before starting operation, the names and functions of the parts of the NT631/NT631C are described here as a confirmation. A method of hardware settings is also described.

### Front View

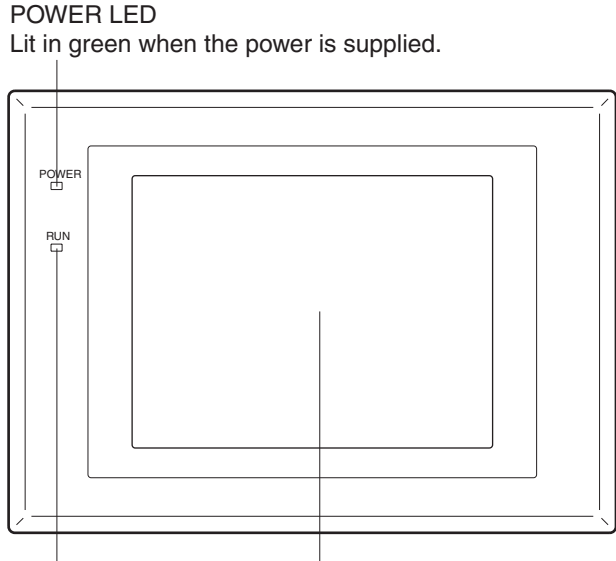

**POWER LED**  
Lit in green when the power is supplied.

**RUN LED**

- Lit in green while the unit is in the RUN mode.
- Lit in orange or red when the battery is low (orange in the RUN mode, red in other modes).

**Display**  
Depending on the model, different display types are used.

- NT631-ST211□-EV2: Monochrome EL display
- NT631C-ST141□-EV2: STN color LCD display with backlight
- NT631C-ST151/152□-EV2: TFT color LCD high intensity display with backlight

The whole area of the screen is a touch panel which works as an input device.

**Reference:** The NT631/NT631C comes in two body colors.

| NT631 (EL)       | NT631C (STN)      | NT631C (TFT)      | Body Color |
|------------------|-------------------|-------------------|------------|
| NT631-ST211-EV2  | NT631C-ST141-EV2  | NT631C-ST153-EV3  | Beige      |
| NT631-ST211B-EV2 | NT631C-ST141B-EV2 | NT631C-ST153B-EV3 | Black      |

Rear View

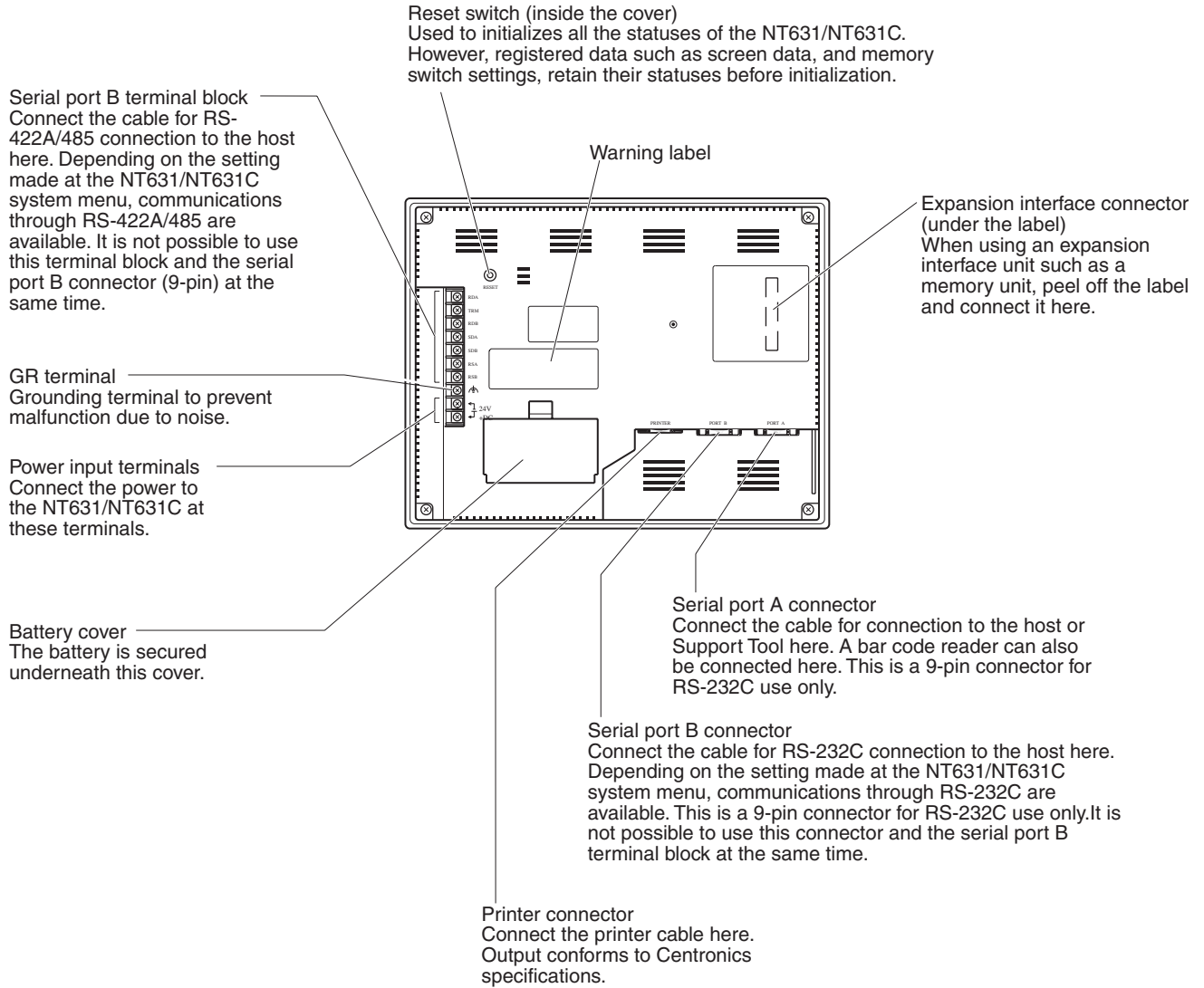

**Note** Confirm system safety before turning the power ON/OFF or resetting.



# SECTION 3

## Hardware Settings and Connections

This section describes the settings of the NT631/NT631C and methods for connection to peripheral devices.

For details on the method for connection to the host, refer to *SECTION 4 Connecting to the Host from the RS-232C Port* or *SECTION 5 Connecting to the Host from the RS-422A/485 Port*.

|       |   |    |
|-------|---|----|
| 3-1   | Installation . . . . .                        | 32 |
| 3-1-1 | Installation Environment . . . . .            | 32 |
| 3-1-2 | Installation in the Operation Panel . . . . . | 32 |
| 3-1-3 | Power Supply Connection . . . . .             | 33 |
| 3-1-4 | Grounding . . . . .                           | 34 |
| 3-2   | Connecting to the Support Tool . . . . .      | 35 |
| 3-3   | Connecting a Printer . . . . .                | 36 |
| 3-3-1 | Connection Method . . . . .                   | 36 |
| 3-4   | Connecting a Bar Code Reader . . . . .        | 36 |
| 3-4-1 | Connection Method . . . . .                   | 37 |
| 3-4-2 | Setting a Bar Code Reader . . . . .           | 37 |
| 3-4-3 | Data Format . . . . .                         | 38 |
| 3-5   | Using a Memory Unit . . . . .                 | 39 |
| 3-5-1 | Installation Method . . . . .                 | 40 |
| 3-5-2 | Method of Use . . . . .                       | 40 |

- Note** On unpacking the NT631/NT631C and peripheral devices, check their external appearance and confirm that there is no damage. Also confirm that there is no abnormal noise on shaking the PT lightly.

## 3-1 Installation

Install the NT631/NT631C in the operation panel and connect the power to the NT631/NT631C as described below.

### 3-1-1 Installation Environment

Observe the following points when installing the PT in an operation panel.

- Note**
1. Do not install the PT at sites subject to the following conditions.
    - Severe temperature variations
    - Temperatures or humidities outside the ranges stated in the specifications
    - High humidity, condensation
    - Splashing chemical agents
    - Severe oil splashing
    - Corrosive or flammable gases
    - Strong vibrations or shocks
    - Direct exposure to wind and rain (outdoor sites)
    - Strong ultra-violet irradiation
  2. Take adequate measures to ensure shielding if the PT is used at a location subject to any of the following conditions.
    - Static electricity, or noise from other equipment
    - Strong electromagnetic fields
    - Nearby power cables
    - Potential exposure to radioactivity

### 3-1-2 Installation in the Operation Panel

The NT631/NT631C is mounted in an operation panel by embedding it in the panel.

Use the panel fittings and tool (Phillips screwdriver) included in the product package and follow the procedure below.

- 1,2,3...**
1. Open a hole of the dimensions shown below in the panel and install the NT631/NT631C from the front side of the panel.

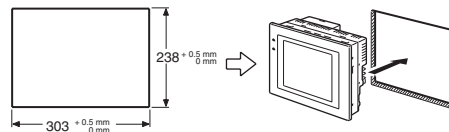

2. Attach the panel fittings at the following positions shown below, from the rear of the NT631/NT631C.  
Fit the hook of the fitting in the square hole in the body and tighten the screw with the Phillips head screwdriver while lightly pulling the fitting.



**Power Supply**

The applicable power supply specifications are as follows.

| Item   | Value   |
|--|---|
| Power supply                                     | 24 VDC  |
| Allowable power supply voltage fluctuation range | 20.4 to 26.4 VDC (24 VDC -15% to +10%)  |
| Power supply voltage capacity                    | NT631-ST211 (B)-EV2:<br>30 W or more (Power supply warm-up time within 200 ms.)<br>NT631C-ST141 (B) /ST153 (B)-EV3:<br>18 W or more |

**Parts Used for Connection**

**Note** For the connection to the power supply terminal block, twisted wires of 2 mm<sup>2</sup> or greater cross sectional area and M3.5 size crimp terminals must be used.

Tighten the screws on the terminal block to a torque of 0.8 N·m.

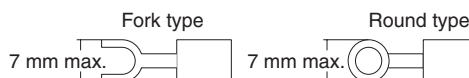

**Recommended Terminals**

| Maker                         | Type (fork type) | Type (round type) | Applicable Wire (stranded wire) |
|-------------------------------|------------------|-------------------|---------------------------------|
| Japan Solderless Terminal MFG | 2-YS3A           | 2-3.5             | 2.0 to 2.63 mm <sup>2</sup>     |
| Fuji Terminal                 | 2-YAS3.5         | V2-S3.5           |                                 |
| Nichifu Terminal              | 2Y-3.5           | 2-3.5             |                                 |

**Note** Conformance to Shipbuilding Standard

- Cover the entire PT with electromagnetic shielding, and ground the electromagnetic shielding to the control panel with copper tape or other electrically conductive tape.

Recommended electromagnetic shielding: E09F100 or E09R13502P

Manufacturer: Seiwa Electric MFG, Co., Ltd.

- Use gaskets or other materials to completely shield all openings and other gaps in the control panel.
- Use copper tape or other electrically conductive tape to shield gaps between the cutout and the PT before securing the PT in place.
- To suppress noise terminal voltage, perform installation under the following conditions. It is recommended to use the following product for the DC power supply.

Recommended Power Supply model: S82K-03024

Manufacturer: OMRON

**3-1-4 Grounding**

The NT631/NT631C has a functional ground terminal (⏏).

Carry out wiring under the following conditions.

- 1,2,3...
1. In cases where there is a potential difference between the grounds of the NT631/NT631C and the host, ground as shown in Fig. If there is some distance between the NT631/NT631C and host and grounding at a single point is difficult, do not connect the functional ground terminal (⏏) of the NT631/NT631C.
  2. If the NT631/NT631C is installed in the same panel as equipment that generates noise, such as a motor or inverter, do not ground the functional ground terminal (⏏) of the NT631/NT631C.

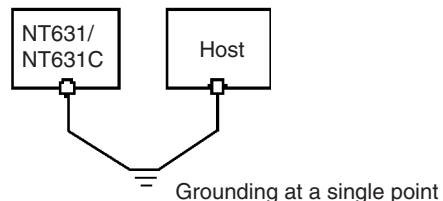

**Note** Carry out grounding correctly in order to prevent operating errors due to noise.

## 3-2 Connecting to the Support Tool

In order to install the system program in the NT631/NT631C, or to transmit screen data created with the Support Tool to the NT631/NT631C, the NT631/NT631C must be connected to a personal computer with an RS-232C cable.

The NT631/NT631C connects the RS-232C cable from a personal computer at serial port A. When the host is connected at serial port B, the connection with the host can be maintained as it is while the NT631/NT631C is connected to the RS-232C cable from a personal computer.

However, when a bar code reader is being used, it must be disconnected, so that the RS-232C cable can be connected, since they both use serial port A.

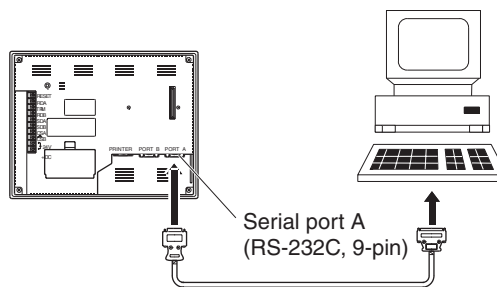

### **Communications Conditions**

The communications conditions are automatically set when the system installer and Support Tool are started.

### **Recommended Connector Cable**

Use the cable indicated below.

- CV500-CN228 (length: 2 m), made by OMRON (D-SUB 9-pin, male ⇔ D-SUB 25-pin, male)
- XW2Z-S001 (conversion cable), made by OMRON (D-SUB 25-pin, female ⇔ half pitch 14-pin, male)
- XW2Z-S002 (length: 2 m), made by OMRON (D-SUB 9-pin, male ⇔ D-SUB 9-pin, female)

For details on making a connector cable, refer to *Appendix F Making the Cable for Connecting a PLC*.

## 3-3 Connecting a Printer

Connecting a printer to the NT631/NT631C enables printing of hard copies of the currently displayed screen (printing of screen images), and, by system menu operations, printing of the screen display history and alarm history.

The following types of data can be printed, depending on the printer connected to the NT631/NT631C. For details, refer to the pages cited.

- Hard copies of the screen (Refer to information on printing data and checking the printer status in the *NT31/NT31C/NT631/NT631C Programmable Terminal Reference Manual*.)
- Screen display history record data (page 194)
- Alarm history record data (page 196)

### 3-3-1 Connection Method

Connect the printer to the NT631/NT631C with a Centronics cable, as shown below. The length of the cable should not exceed 1.5 m.

**Reference:**

If the connector cable is connected or disconnected while the power to the printer is on, the NT631/NT631C may malfunction. Always turn off the power to the printer before connecting or disconnecting the cable.

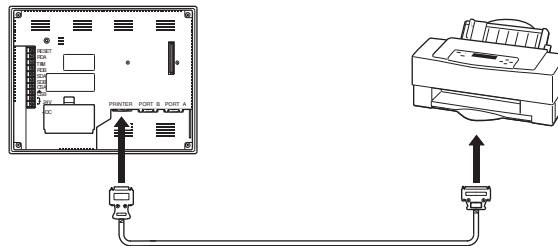

#### **Recommended Connector Cable**

The following connection cables are recommended.

NT-CNT121 (1.5 m, 20-pin to 36-pin), made by OMRON

#### **Recommended Printers**

When using a printer, use one that can emulate an NEC PC-PR201H (using the NEC PC-PR201PL control protocol) or complies with one of the following EPSON control standards: ESC/P 24-J83C (color), or ESC/P 24-J82 (monochrome).

When using a monochrome printer with an NT631C, set Tone printing with the NT631C memory switches (page 169).

## 3-4 Connecting a Bar Code Reader

Connecting a bar code reader to the NT631/NT631C enables bar code data to read as character strings into character string input fields, and set in character string memory tables.

In order to use a bar code reader, the Comm. A Method memory switch must be set to Bar-Code Reader.

For details on the method for inputting character strings with a bar code reader, refer to *3-7 Input of Numeric values and Character Strings* in the *NT31/NT31C/NT631/NT631C Programmable Terminal Reference Manual*.

**Note** Make sure that the power supply to the bar code reader and the power supply to the PT are both OFF before connecting or disconnecting the cable.

### 3-4-1 Connection Method

Connect the bar code reader to serial port A of the NT631/NT631C, as shown in the figure below.

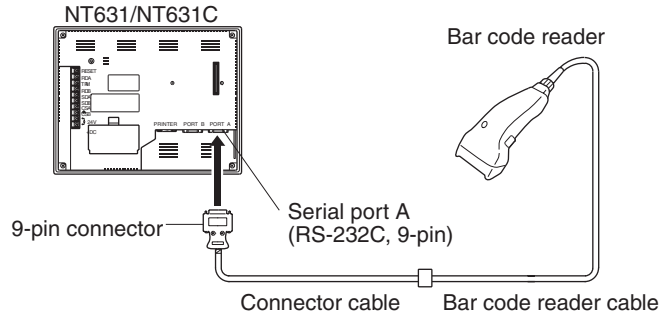

Bar code reader must match the communications setting (3-4-2 *Setting a Bar Code Reader*, page 37) and data format (3-4-3 *Data Format*, page 38) in order to connect to the NT631/NT631C. Please confirm the specification of the bar code reader before using.

For details on making a connector cable, refer to *Appendix G Making the Cable for Connection to a Bar Code Reader*.

**Reference:** The bar code reader must be connected to serial port A. This means that it cannot be connected at the same time as the Support Tool. Note also that when a bar code reader is used, the host must be connected at serial port B.

### 3-4-2 Setting a Bar Code Reader

After connecting a bar code reader, set the communications conditions and other settings for it by selection from the system menu.

#### Settings at the NT631/NT631C

At the NT631/NT631C, set the communications conditions for communications with the bar code reader by using the memory switches, selecting from the options indicated in the table below.

For more detailed information on the actual system menu operations, refer to 6-10 *Setting the Bar Code Reader Input Function*.

| Item                 | Possible Settings     | Default Setting |
|----------------------|-----------------------|-----------------|
| Data bits            | 7 or 8 bits           | 7 bits          |
| Stop bit(s)          | 1 or 2 bits           | 2 bits          |
| Parity               | None, odd, even       | Even            |
| Communications speed | 4800, 9600, 19200 bps | 9600 bps        |
| Input Method         | Manual, Auto          | Manual          |

#### Settings at the Bar Code Reader

Make the settings shown in the table below at the bar code reader. Make sure that the communications speed, parity, stop bit, and data bit settings match the communications settings made at the NT631/NT631C. For details on the setting method, refer to the instruction manual for the bar code reader used.

| Item                 | Possible Settings     |
|----------------------|-----------------------|
| Communications speed | 4800, 9600, 19200 bps |
| Parity               | EVEN, ODD, NONE       |
| Stop bits            | 1 or 2 bits           |
| Data bits            | 7 or 8 bits           |

| Item  | Possible Settings                     |
|---|---------------------------------------|
| Preamble  | STX                                   |
| Postamble                                       | ETX                                   |
| RS/CS control                                   | Available                             |
| Communications protocol                         | No-protocol mode                      |
| Transmission of number of bar code label digits | Transmission prohibited               |
| Transmission of ID characters                   | Transmission prohibited               |
| Bar code types                                  | Multi-reading (all types can be read) |
| Trigger switch setting                          | Automatic reading mode                |

**About RS/CS Control**

During bar code reading, the NT631/NT631C performs RS/CS control. When the Input Method setting of the NT631/NT631C is set to Auto, the RS signal is turned OFF, prohibiting the next input, until the read data has been sent to the host as notification.

Because of this, when the Auto setting is made, the next input is not possible until the data has been sent to the host as notification.

However, when the setting is Auto and the RS/CS signals of the cable are shorted, RS/CS control is ineffective. Consequently, data input from the bar code reader to the NT631/NT631C is updated regardless of whether or not the data is sent to the host as notification.

For details, refer to the instruction manual for the bar code reader used.

**3-4-3 Data Format**

The data format for communications when using the bar code input function of the NT631/NT631C is shown below.

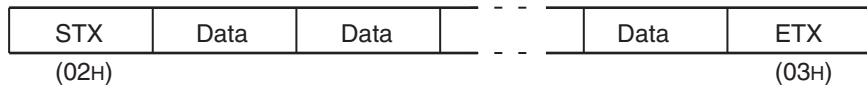

The characters which are effective as data are hexadecimal codes from 20 to 7FH, and the maximum data length is 40 bytes.

Data which does not follow the data format described above is invalidated and discarded.



## 3-5 Using a Memory Unit

This section discusses the use of the Memory Unit.

**Reference:** The Memory Unit functions are determined by the model of PT being used, regardless of the version of the system program installed in the PT.

| PT Model          | Function of Memory Unit                                   |
|-------------------|---|
| Without V□ suffix | System programs can not be transmitted using Memory Unit. |
| With V□ suffix    | System programs can be transmitted using Memory Unit.     |

By installing a Memory Unit (NT-MF261) on the NT631/NT631C, the screen data in the NT631/NT631C can be recorded (backed up) in the Memory Unit.

In addition, the screen data in the Memory Unit can be automatically read into the NT631/NT631C when it starts up. This means that system program and screen data can be changed easily at the operation site without connecting to the Support Tool.

The data in the Memory Unit is retained without backup by a battery or other means.

In systems where there are frequent setup changes, by preparing a number of Memory Units in advance and recording screen data in them in accordance with the control performed in each case, the NT631/NT631C screen data can be changed simply by installing the Memory Unit, without connecting to the Support Tool.

In addition, even if NT631/NT631C is replaced, the previous status can be maintained simply by installing the Memory Unit that retains the system program and screen data of the previous NT631/NT631C.

By using the following combinations, data can be stored (backed up) to a Memory Unit.

- Screen data for two PTs.
- System program for two PTs.
- System program and screen data for one PT.

One Memory Unit can store the screen data for two PTs.

- Note**
1. Make sure that the power supply to the PT is OFF before connecting or disconnecting a Memory Unit.  
After mounting a Memory Unit, be sure to tighten its two screws.
  2. During data transmission, do not turn off the power supply to the NT631/NT631C or reset it.
  3. Do not touch the PCB (printed circuit board) with bare hands.

- Reference:**
- When a Memory Unit is mounted, the NT631/NT631C cannot be set to the operating status. On completion of data transmission with a Memory Unit, always disconnect the Memory Unit from the NT631/NT631C before starting NT631/NT631C operation.
  - Memory Units (NT-MF261) can be used in common for the following PT models: NT31, NT31C, NT631, and NT631C. One Memory Unit can store screen data for up to two PTs of different models. However, since the data compatibility is not complete between NT31/NT31C and NT631/NT631C, an error may occur if an attempt is made to read NT631C data with an NT31C. (The data must be converted using the Support Tool.)

Note also that although there is data compatibility between the NT31 and NT31C, and between the NT631 and NT631C, the display may not be correct since these models have different numbers of colors.

- One Memory Unit can store a system program for up to two PTs of different models. In order to transmit a system program from the Memory Unit to the NT631/NT631C, the system program must be compatible to the target PT model.
- The statuses of memory switch settings and system settings can be recorded to the Memory Unit besides screen data. When the data in the Memory Unit is written into the NT631/NT631C, make sure that these settings can be adapted to the NT631/NT631C used before transmission.

### 3-5-1 Installation Method

Install the Memory Unit (NT-MF261) at the expansion interface connector at the rear of the NT631/NT631C as shown in the figure below (the expansion interface connector is located underneath the note label.).

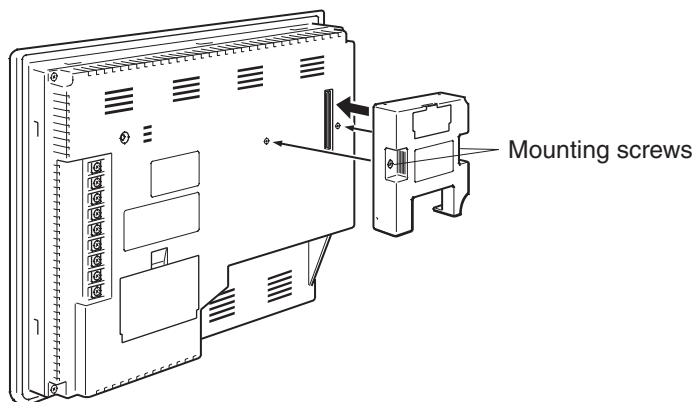

### 3-5-2 Method of Use

As shown in the figure below, a Memory Unit has two sets of four DIP switches, and the operation is determined by the DIP switches that are set at startup.

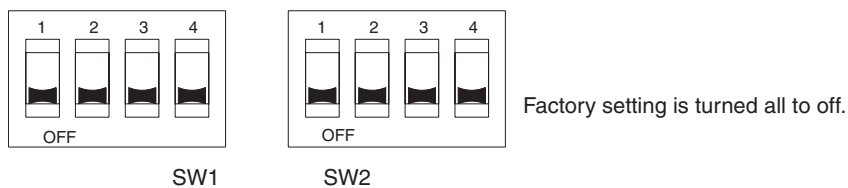

- Note**
1. Always confirm that the power to the NT631/NT631C is off before setting the DIP switches.
  2. Do not touch the PCB (printed circuit board) directly with bare hands.

#### DIP Switch Functions

The functions of the DIP switches on the Memory Unit are indicated in the table below.

#### SW1

| Switch | Function  |                   |
|--------|---|-------------------|
| SW1-1  | Automatic transmission (writing from the Memory Unit to the PT) | OFF: Not executed |
|        |   | ON: Executed      |
| SW1-2  | Automatic transmission (writing from the PT to the Memory Unit) | OFF: Not executed |
|        |   | ON: Executed      |

| Switch | Function   |                    |
|--------|--|--------------------|
| SW1-3  | Manual transmission (Direction of transmission and bank used selected at the PT touch panel) | OFF: Not executed  |
|        |  | ON: Executed       |
| SW1-4  | Data type to transfer  | OFF: Screen data   |
|        |  | ON: System program |

**SW2**

| Switch | Function   |              |
|--------|--|--------------|
| SW2-1  | Disable/enable writing to PT                       | OFF: Disable |
|        |  | ON: Enable   |
| SW2-2  | Disable/enable writing to the Memory Unit          | OFF: Disable |
|        |  | ON: Enable   |
| SW2-3  | Area (bank) selection of automatic transmission. * | OFF: Bank 0  |
|        |  | ON: Bank 1   |
| SW2-4  | System/Screen simultaneous transmission            | OFF: Disable |
|        |  | ON: Enable   |

\*: The Memory Unit stores system program or screen data for one PT in each of areas (bank 0, bank 1). (The total data storage is for two PTs.) SW2-3 sets which of these two banks is used for automatic transmission.

**Reference:**

- In the following cases, a mode setting error occurs.
  - More than one of the SW1-1 to SW1-3 switches are set to ON.
  - None of the SW1-1 to SW1-3 switches are set to ON.
- In the following case, a protect setting error occurs.  
Transmitting to the write destination has been disabled by the setting for SW2-1 or SW2-2.
- In the following cases, a data transmission error occurs.
  - An attempt is made to transmit data other than the system program to PT system program area.
  - An attempt is made to transmit the system program to PT screen data area.
- For details on mode setting errors and protect setting errors, refer to *Errors When Using a Memory Unit* (page 45).

**Writing Screen Data to a Memory Unit Using Automatic Transmission (PT to Memory Unit)**

In this mode, system program or the screen data in the NT631/NT631C is forcibly written to the Memory Unit irrespective of the setting status of the NT631/NT631C.

This mode is convenient if the touch panel is broken and touch switch operation is not possible, or if someone unfamiliar with touch switch operation at the operation site is using the system.

**Reference:**

When screen data is written to the Memory Unit, the data that has been stored in the specified area up until that point is lost (if the data is written into only one Bank, the other Bank will not be affected).

**Method of Execution**

Use the following procedure to write the screen data in the NT631/NT631C to the Memory Unit by automatic transmission.

- 1,2,3... 1. Check that the power supply to the NT631/NT631C is OFF, then set the DIP switches of the Memory Unit as follows after installing Memory Unit to NT631/NT631C.

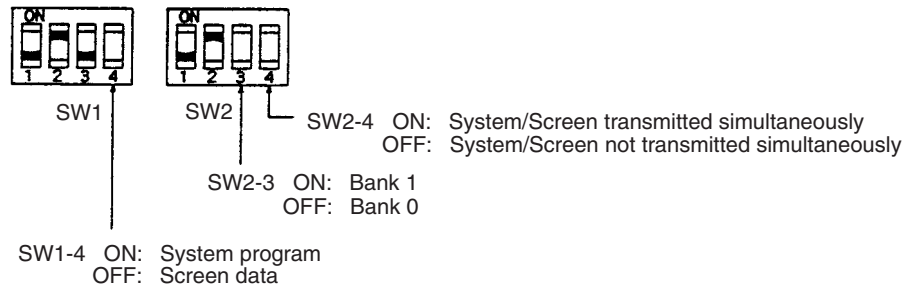

It is not strictly necessary to set SW2-1 to OFF (to disable writing to the PT), but it is recommended to do so to avoid loss of data in the event of operating errors.

**Reference:**

- Setting SW2-4 to ON (System/Screen transmitted simultaneously) disables the setting of SW1-4.
- Setting SW2-4 to ON (System/Screen transmitted simultaneously) disables the setting of SW2-3, writes the system program into bank 0, and the screen data into bank 1 at all times.

2. Switch the NT631/NT631C power ON.

The screen data is automatically written into the Memory Unit. The screen data in the NT631/NT631C is preserved.

The messages Preparing, Transmitting, Verifying, and Finished are displayed on the screen in accordance with the progress of data writing.

At the same time, the progress of the data writing status is displayed by the means of the number of bytes and blocks (1 bank = 16 block = 1024k byte).

RUN LED operates as follows according to the processing status.

Preparing: flashes at intervals of 1 second  
 Transmitting: flashes at intervals of 0.5 second  
 Verifying: flashes at intervals of 0.5 second  
 Finished: lights up

3. Switch the NT631/NT631C power OFF, remove the Memory Unit.

To operate NT631/NT631C continuously, switch the NT631/NT631C power back ON.

**Writing Screen Data to the PT Using Automatic Transmission (Memory Unit to PT)**

In this mode, the system program or screen data in the Memory Unit is forcibly written to NT631/NT631C irrespective of the setting status of the NT631/NT631C.

Since data transmission by this method is faster than when the Support Tool or system installer is used, it can save a lot of time. When transmitting the same system program or screen data to multiple NT631/NT631C, this mode becomes convenient.

**Reference:** When data is written to the NT631/NT631C, the data that has been stored up until that point is lost. When the system program is changed, the operation of NT631/NT631C also changes.

### Method of Execution

Use the following procedure to write the screen data in the Memory Unit to the NT631/NT631C by automatic transmission.

1,2,3...

1. Check that the NT631/NT631C power is OFF, then set the DIP switches on the Memory Unit as follows after installing Memory Unit to NT631/NT631C.

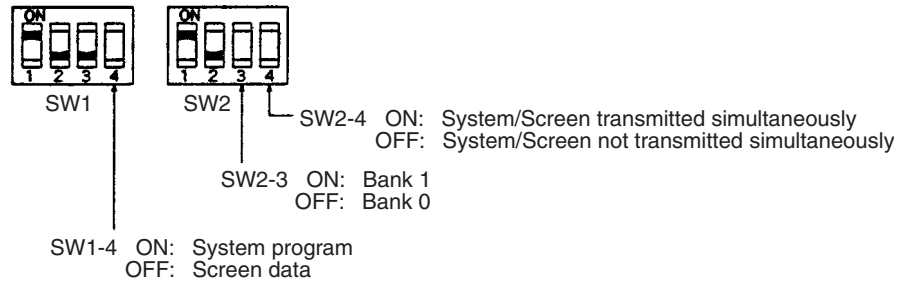

It is not strictly necessary to set SW2-2 to OFF (to disable writing to the Memory Unit), but it is recommended to do so to avoid loss of data in the event of operating errors.

**Reference:**

- Setting SW2-4 to ON (System/Screen transmitted simultaneously) disables the setting of SW1-4.
- Setting SW2-4 to ON (System/Screen transmitted simultaneously) disables the setting of SW2-3. In this case, the data transmission becomes possible only if the data inside Memory Unit is in either of following combinations.

Bank 0: system program, Bank 1: other than system program

Bank 0: other than system program, Bank 1: system program

If the combination is not as listed above, a data transmitting error occurs.

- When writing the system program into the NT631/NT631C, the type of system program inside Memory Unit and the type of PT must correspond.

2. Switch the NT631/NT631C power ON.

The screen data is automatically written into the PT.

The messages Preparing, Transmitting, Verifying and Finished are displayed on the screen in accordance with the progress of data writing.

At the same time, the progress of data writing status is displayed by the means of the number of bytes and blocks (1 bank = 16 block = 1024k byte).

The RUN LED operates as follows according to the processing status.

Preparing: flashes at intervals of 1 second

Transmitting: flashes at intervals of 0.5 second

Verifying: flashes at intervals of 0.5 second

Finished: lights up

3. Switch the NT631/NT631C power OFF, remove the Memory Unit.

To operate NT631/NT631C continuously, switch the NT631/NT631C power back ON.

### Reading and Writing Data by Manual Transmission

In this method, the direction of transmission and area of the Memory Unit used are set by touch switch operations at the NT631/NT631C. Transmission can be executed while checking the settings.

**Reference:** When data is written to the NT631/NT631C or Memory Unit, the data that has been stored up until that point is lost.

### Method of Execution

Use the following procedure to write screen data using manual transmission.

- 1,2,3...**
1. Check that the NT631/NT631C power is OFF, then set the DIP switches on the Memory Unit as follows.

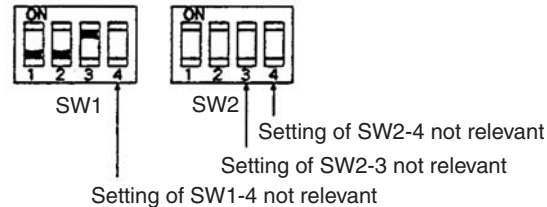

In order to avoid loss of data in the event of operating errors, it is advisable to set SW2-1 and SW2-2 so as to disable writing to the PT from which the data is to be read.

2. Switch the NT631/NT631C power ON.  
Display language select screen appears.



3. Press the Japanese or English touch switches to select the display language.  
The following descriptions are for when English is selected.  
The screen shown below is displayed.

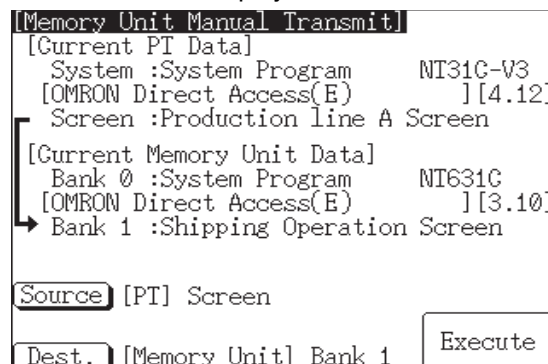

### Current PT Screen Data, System

The first line: Compatible PT type for the system program inside PT.  
The second line: System program name and Version for the system program inside PT.

(The second line may not be displayed in the kind of system program.)

### Current PT Screen Data, Screen

The comment for the screen data in the NT631/NT631C is displayed here.

**Current Memory Unit Screen Data**

- In the case of system program:
  - The first line: Compatible PT type for the system program inside the Memory Unit.
  - The second line: System program name and Version for the system program inside the Memory Unit.
 (The second line may not be displayed in the system program for some models.)
- In the case of screen data:
  - The comment for the screen data in the NT631/NT631C is displayed here.

The available transmitting destinations are altered depending on the settings of the origin of transmitting as described in the table below.

| Source               | Destination  |
|----------------------|--|
| PT screen            |  |
| PT system            |  |
| PT system/screen     | Memory Unit Bank 0/1 (fixed)   |
| Memory Unit Bank 0   | If system program is selected  |
| Memory Unit Bank 1   | PT system (fixed)<br>If screen data is selected<br>PT screen (fixed) |
| Memory Unit Bank 0/1 | PT system/screen (fixed)   |

**Reference:**

- When transmitting the system program and screen data simultaneously from the PT to the Memory Unit, the setting of banks is Bank 0: system program, Bank 1: screen data, and when transmitting them from the Memory Unit to the PT, either of the following combinations must be used.
    - Bank 0: system program, Bank 1: other than system program
    - Bank 0: other than system program, Bank 1: system program
  - When writing the system program into the NT631/NT631C, the type of system program inside Memory Unit and the type of PT must correspond.
4. Press Execute.
 

The data is transmitted.

The messages Preparing, Transmitting, Verifying, and Finished are displayed in accordance with the progress of data transmission. At the same time, the progress of data transmitting status is displayed by the means of the number of bytes and blocks (1 bank = 16 block = 1024k byte).

When the data transmission is operated manually, RUN LED remains OFF.
  5. Switch the NT631/NT631C power OFF, remove the Memory Unit, then switch the NT631/NT631C power back ON.

**Errors When Using a Memory Unit**

If an error occurs when using the Memory Unit, the NT631/NT631C operates as follows.

- The details of the error and remedial action are displayed on the screen.
 

Each screen has touch switches to change the display language from one to the other. When the manual data transmission is operating, the content of error and remedial action are shown with selected language. When the automatic transmission is operating, it is displayed in Japanese.
- The continuous buzzer sounds.

- The RUN LED flashes.

If a protect setting error occurs when executing manual transmission, it is possible to return to the Memory Unit manual transmission screen by pressing the OK touch switch, but in the case of other errors, the status described above remains in effect until the NT631/NT631C power is turned OFF or reset.

**Within the PT Model, the system program inside memory compatible PT model**

The compatibility relationships are shown below.

|                 |   |
|-----------------|---|
| NT631<br>NT631C | System program for NT631/NT631C without the -V suffix, and for NT631/NT631C with the -V1 and -V2 suffix |
| NT631C-EV3      | System program for NT631C with the -V3 suffix   |

When an error occurs, take remedial action by referring to the table below.

| Error   | Probable Cause  | Remedial Action   |
|---|---|---|
| Mode setting error  | DIP switches SW1-1 to SW1-3 are all OFF, or more than one is ON.  | Turn the NT631/NT631C power OFF, set the Memory Unit DIP switches correctly, then turn the NT631/NT631C power back ON.  |
| Protect setting error (automatic transmission)            | Writing to the data write destination has been prohibited by the setting of SW2-1 or SW2-2.   | Turn the NT631/NT631C power OFF, set the Memory Unit DIP switches correctly, then turn the NT631/NT631C power back ON.  |
| Protect setting error (manual transmission)               | Writing to the data write destination has been prohibited by the setting of SW2-1 or SW2-2.   | Perform either of the following procedures. <ul style="list-style-type: none"> <li>• Press the OK touch switch to return to the Memory Unit manual transmission screen, make the correct settings, then try again.</li> <li>• Turn the NT631/NT631C power OFF, correct the DIP switches settings of the Memory Unit, then turn the power back ON.</li> </ul>              |
| Flash memory error  | An error occurred during initialization of the NT631/NT631C or Memory Unit flash memory, or during write processing.  | Turn the NT631/NT631C power OFF, then back ON. If the error recurs, the flash memory at the write destination may be faulty. In this case, replace the PT.  |
| Verify error  | An error occurred during verification processing at the flash memory of the NT631/NT631C or the Memory Unit.  | Turn the NT631/NT631C power OFF, then back ON. If the error recurs, the flash memory at the write destination may be faulty. In this case, replace the PT.  |
| Transmitting data error (The automatic transmission only) | An attempt is made to transmit data other than a system program or the system program of a different PLC model into the NT631/NT631C as the system program.<br>An attempt is made to write a system program into the NT631/NT631C as screen data. | Perform either of the following procedures. <ul style="list-style-type: none"> <li>• Turn the NT631/NT631C power OFF, correct the DIP switch settings of the Memory Unit, and then turn the power back ON.</li> <li>• Turn the NT631/NT631C power OFF, set the DIP switch settings to the manual transmission, and then check the data inside the Memory Unit.</li> </ul> |



# SECTION 4

## Connecting to the Host from the RS-232C Port

This section describes the method for connecting to the host using the RS-232C port of the PT.

|       |  |    |
|-------|--|----|
| 4-1   | Connecting to the RS-232C Port at the Host . . . . . | 48 |
| 4-1-1 | Host Types and Settings . . . . .                    | 48 |
| 4-1-2 | Connecting Directly between RS-232C Ports . . . . .  | 73 |

## 4-1 Connecting to the RS-232C Port at the Host

The method for connecting between the RS-232C port of the PT and the RS-232C port of the host is as follows.

The following discussion is focused on the connection method to OMRON PLCs (By using the memory link method, a connection can be made to any arbitrary RS-232 unit). When making a connection to a host other than OMRON PLCs, refer to the *PLC Connection Manual (V042-E1-□)* or *NT31/631 Multi Vendor Connection Manual (V060-E1-□)*.

### Direct Connection Between The RS-232C Ports Using an RS-232C Cable (page 73)

This is the easiest connection method. Depending on the host to which the connection is to be made, it may be possible to use OMRON cables with connectors.

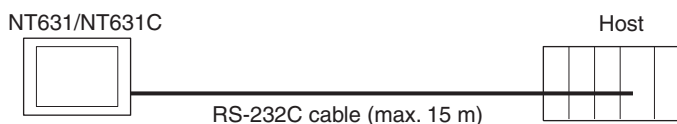

**Reference:** The CS/CJ-series CPU Unit cannot be connected with the 1:1 connection NT Link method. Use the 1:N connection NT Link method instead to make the 1:1 connection. For details, refer to *Using the NT Link (1:N) Method (page 65)* or *Using the High-speed NT Link (1:N) Method (page 70)*.

### 4-1-1 Host Types and Settings

The types of host that can be connected to a PT by using the RS-232C ports of both Units, and the settings to be made at the host, are described here.

#### When Using the Host Link Method

#### Compatible Host Units

Some models and series of OMRON PLCs have the host link function built in. In the CS/CJ-series or CQM1H PLCs, the host link method can be used by installing a Serial Communications Board/Unit. In addition, some C200HX/HG/HE(-Z)E CPU Unit can be connected in the host link method by installing a Communications Board.

Check the model and series of the PLC, the type of installed Serial Communications Board, Serial Communications Unit, or Host Link Unit before making a connection.

The hosts that can be connected to the NT631/NT631C by the host link method using the RS-232C ports of both Units are indicated in the table below.

| PLC Series | Units with Built-in Host Link Function | CPU Units Connectable with Host Link Units or Expansion Communications Board/Units | Host Link Unit or Communications Board/Unit | Connectable to |
|------------|--|--|---|----------------|
| CS Series  | CS1G-CPU42/43/44/45-E(V1)              | CS1G-CPU42/43/44/45-E(V1)  | CS1W-SCU21(-V1)                             | CS1G           |
|            | CS1H-CPU63/64/65/66/67-E(V1)           | CS1H-CPU63/64/65/66/67-E(V1)   | CS1W-SCB21(-V1)                             | CS1H           |
|            | CS1G-CPU42H/43H/44H/45H                | CS1G-CPU42H/43H/44H/45H  | CS1W-SCB41(-V1)                             | CS1D           |
|            | CS1H-CPU63H/64H/65H/66H/67H            | CS1H-CPU63H/64H/65H/66H/67H  |   |                |
|            | CS1D-CPU65H/67H                        | CS1D-CPU65H/67H <sup>(*)</sup>   |   |                |
| CJ Series  | CJ1G-CPU44/45                          | CJ1G-CPU44/45  | CJ1W-SCU21(-V1)                             | CJ1G           |
|            | CJ1G-CPU42H/43H/44H/45H                | CJ1G-CPU42H/43H/44H/45H  | CJ1W-SCU41(-V1)                             | CJ1H           |
|            | CJ1H-CPU65H/66H/67H                    | CJ1H-CPU65H/66H/67H  |   | CJ1M           |
|            | CJ1M-CPU11/12/13/22/23                 | CJ1M-CPU11/12/13/22/23   |   |                |
|            |  |  |   |                |

| PLC Series          | Units with Built-in Host Link Function             | CPU Units Connectable with Host Link Units or Expansion Communications Board/Units  | Host Link Unit or Communications Board/Unit | Connectable to   |
|---------------------|--|---|---|--|
| C Series            |  | C1000H-CPU01-EV1<br>C2000H-CPU01-EV1  | C120-LK201-EV1                              | C1000H<br>C2000H   |
|                     |  | C200HS-CPU01/03/21/23/<br>31/33-E<br>C200HE-CPU11/32/42-E<br>C200HE-CPU11/32/42-ZE<br>C200HG-CPU33/43/53/63-E<br>C200HG-CPU33/43/53/63-ZE<br>C200HX-CPU34/44/54/64-E<br>C200HX-CPU34/44/54/64<br>65/85-ZE | C200H-LK201-EV1                             | C200HS<br>C200HE<br>C200HE-Z<br>C200HG<br>C200HG-Z<br>C200HX<br>C200HX-Z |
|                     | C200HS-CPU21/23/31/33-E                            |   | C200HW-COM02/04/<br>05/06-EV1               | C200HS   |
|                     | C200HE-CPU42-E<br>C200HE-CPU42-ZE                  | C200HE-CPU32/42-E<br>C200HE-CPU32/42-ZE   |   | C200HE<br>C200HE-Z   |
|                     | C200HG-CPU43/63-E<br>C200HG-CPU43/63-ZE            | C200HG-CPU33/43/53/63-E<br>C200HG-CPU33/43/53/63-ZE   |   | C200HG<br>C200HG-Z   |
|                     | C200HX-CPU44/64-E<br>C200HX-CPU44/64/65/85-ZE      | C200HX-CPU34/44/54/64-E<br>C200HX-CPU34/44/54/64/<br>65/85-ZE   |   | C200HX<br>C200HX-Z   |
|                     |  | C1000H-CPU01-EV1<br>C2000H-CPU01-EV1  | C500-LK201-EV1                              | C1000H<br>C2000H   |
|                     |  | C1000H-CPU01-EV1<br>C1000HF-CPU01-EV1<br>C2000H-CPU01-EV1   | C500-LK203                                  | C1000H (F)<br>C2000H   |
|                     |  | CPM1-10/20/30CDR-□<br>+CPM1-CIF01   |   | CPM1   |
|                     |  | CPM1A-10/20/30/40CD□-□<br>+CPM1-CIF01   |   |  |
|                     |  | CPM2A-30/40/60CD□□-□<br>+CPM1-CIF01<br>(Peripheral port connection)   |   | CPM2A  |
|                     |  | CPM2C-10/20□□□□□□-□(*2)   |   | CPM2C  |
|                     |  | CQM1-CPU21-E<br>CQM1-CPU41/42/43/44-EV1   |   | CQM1   |
|                     |  | CQM1H-CPU11/21/51/61(*3)  | CQM1H-CPU51/61                              | CQM1H-SCB41<br>CQM1H   |
| CV Series<br>(*4)   | CV500-CPU01-EV1                                    | CV500-CPU01-EV1   | CV500-LK201                                 | CV500  |
|                     | CV1000-CPU01-EV1                                   | CV1000-CPU01-EV1  |   | CV1000   |
|                     | CV2000-CPU01-EV1                                   | CV2000-CPU01-EV1  |   | CV2000   |
| CVM1 Series<br>(*4) | CVM1-CPU01-EV2<br>CVM1-CPU11-EV2<br>CVM1-CPU21-EV2 | CVM1-CPU01-EV2<br>CVM1-CPU11-EV2<br>CVM1-CPU21-EV2  | CV500-LK201                                 | CVM1   |
|                     | SRM1-C02-V1  |   |   | SRM1   |

\*1 This CPU Unit is for a Duplex-CPU Unit System. The CS1W-SCB21/42(-V1) Serial Communications Board cannot be used.

- \*2 Use a CPM2C-CN111 or CS1W-CN114/118 Connecting Cable, CPM1-CIF01 RS-232C Adapter, or CPM1-CIF11 RS-422A Adapter to connect.
- \*3 The CQM1H-CPU11 does not have a built-in RS-232C port, so connect to the peripheral port to the PT with a CS1W-CN118 Connecting Cable.
- \*4 CPU Units of CVM1/CV-series PLCs without the suffix -EV□ cannot be connected.

**Settings at The Host**

When using the host link method, the settings shown below must be made at the host (depending on the Unit, some of these settings may not be necessary, or settings not shown here may be necessary).

| Item                 | Switch Setting                                   |
|----------------------|--|
| I/O port             | RS-232C  |
| Communications speed | Set the same speed as for the NT631/NT631C. (*1) |
| Transfer code        | ASCII, 7 data bits, 2 stop bits                  |
| Parity               | Even   |
| 1-to-1/1-to-N        | 1-to-N(*2)                                       |
| Instruction level    | Level 1, 2, 3                                    |
| Unit #               | 00   |

Set the host link communications speed at 9600 bps or 19200 bps with the memory switch at the NT631/NT631C. For details, refer to 6-7-2 *Setting the Host Link Method* (page 155).

The 1-to-N setting enables BCC (Block Check Character). It is not actually possible to connect more than one NT631/NT631C in a single host link.

The setting methods for each type of Unit are described in the following.

**Connecting to a C-series Host Link Unit**

**C200H/C200HS/C200HE/HG/HX (-Z)E Rack-mounting Unit: C200H-LK201-V1**

**Setting the Front Switches**

Set each switch with a flat blade screwdriver so that the values or symbols in the setting value window agree with the following.

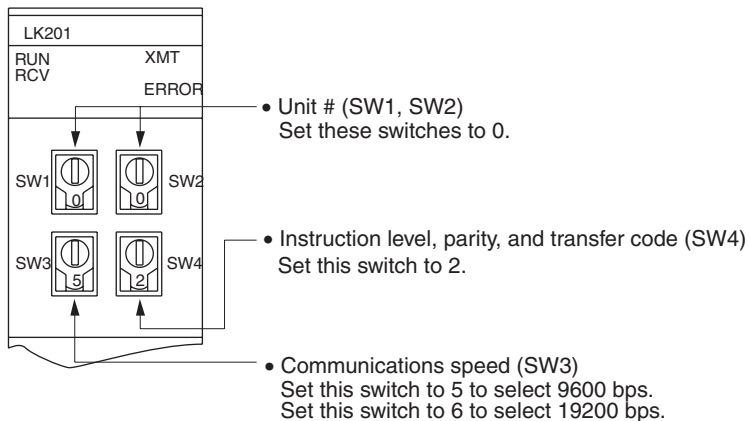

**Setting the Rear Switches**

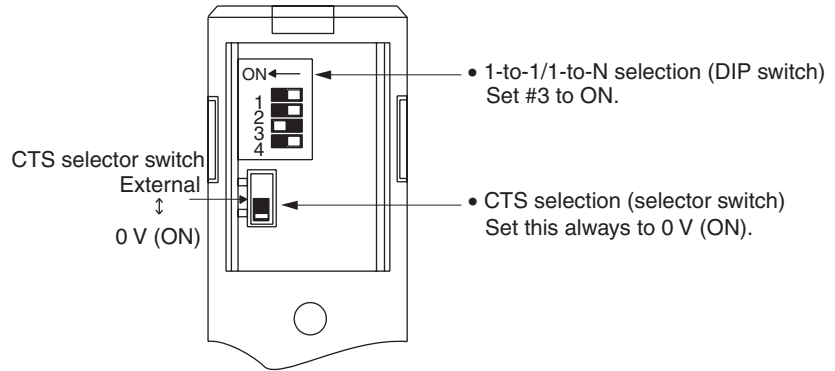

**C1000H(F)/C2000H Rack-mounting Unit: 3G2A5-LK201-EV1**

**Setting the Front Switches**

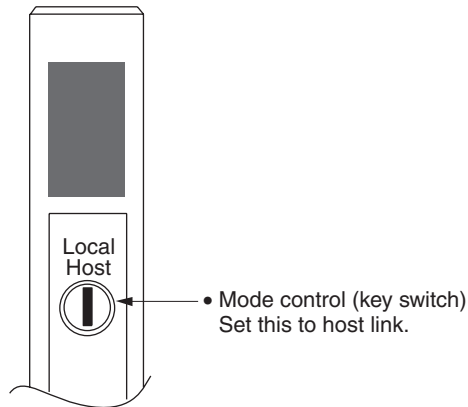

**Setting the Rear Switches**

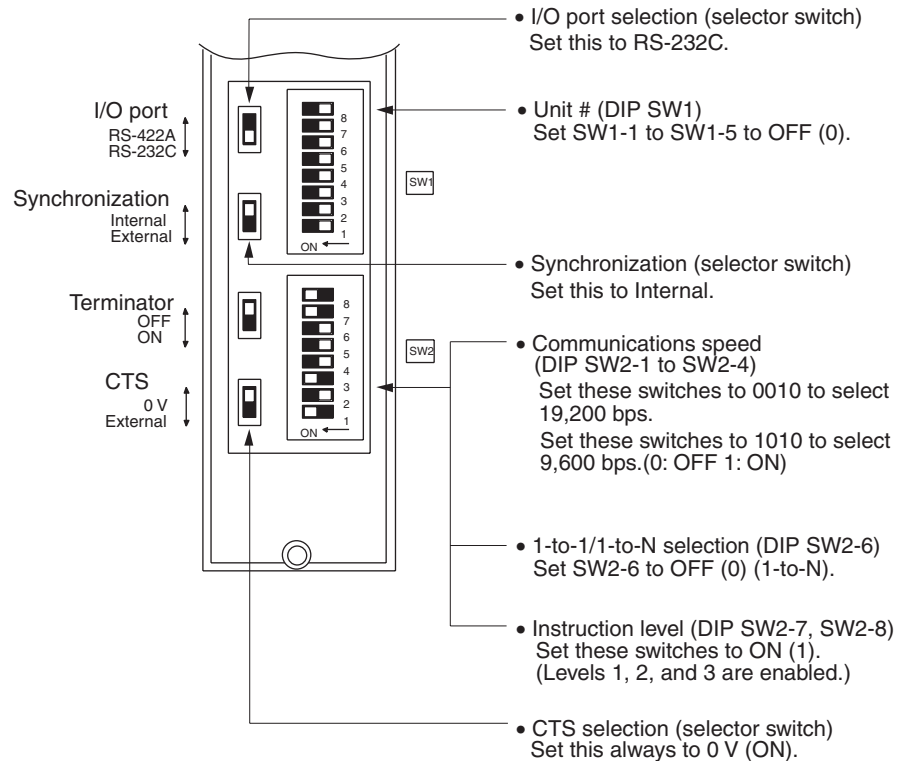

**C1000H/C2000H Rack-mounting Unit: C500-LK203**

**Setting the Rear Switches**

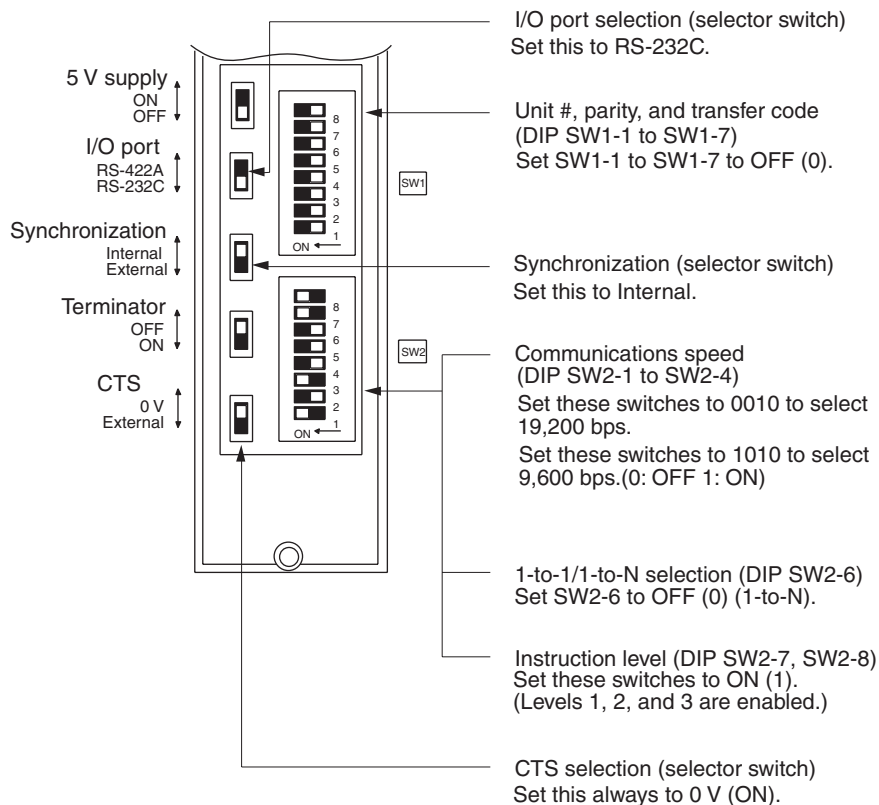

**C200H/C1000H/C2000H CPU-mounting Unit: 3G2A6-LK201-EV1**

**Setting the Rear Switches**

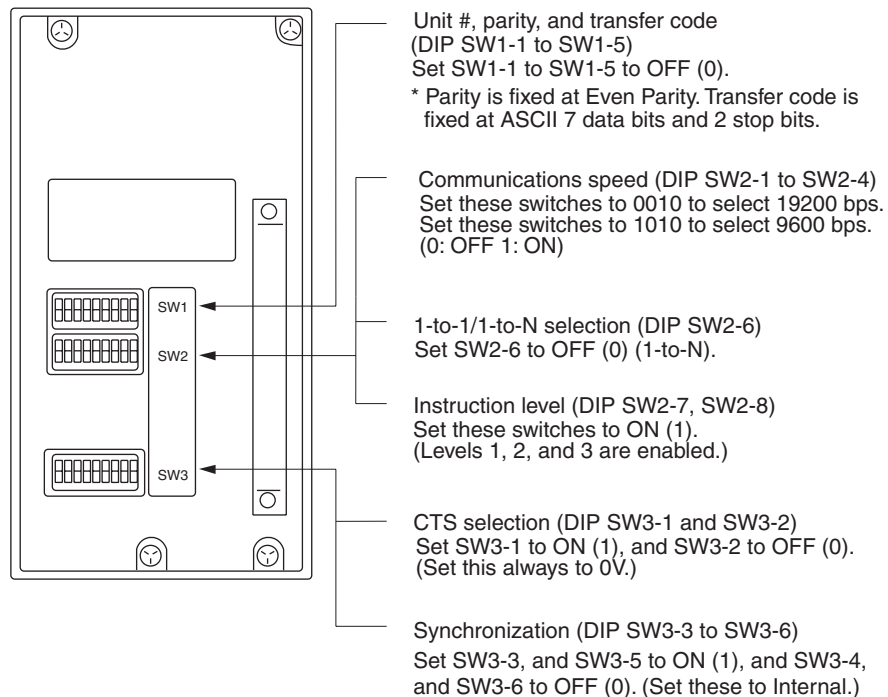

**Connecting to a CVM1/CV-series Host Link Unit**

**CVM1/CV-series Rack-mounting Unit: CV500-LK201**

A CVM1/CV-series Host Link Unit (CV500-LK201) has two connectors (communications ports 1 and 2). Either of these ports can be used for connection to an NT631/NT631C by the RS-232C method. However, since the connectors at these ports are of different types, a cable that matches the connector must be prepared.

- Communications port 1  
Communications port 1 is a 25-pin connector for RS-232C use only.
- Communications port 2  
Communications port 2 is a 9-pin connector which allows selection of the RS-232C or RS-422A method. When this port is used with the RS-232C method, the I/O port selector switch on the front of the PT must be set to RS-232C (the upper position).

**CPU Bus Unit Settings**

When connecting to a CVM1/CV-series Host Link Unit, set the following communications conditions for the CPU Bus Unit settings.

| Item                 | Setting at Host   |
|----------------------|---|
| Communications speed | Set the same speed as set at the NT631/NT631C <sup>(*1)</sup> |
| Transfer code        | ASCII, 7 data bits, 2 stop bits                               |
| Parity               | Even  |
| 1-to-1, 1-to-N       | 1-to-N <sup>(*2)</sup>  |
| Instruction level    | Level 1, 2, 3   |

<sup>\*1</sup> Set the host link communications speed at 9600 bps or 19200 bps with the memory switch at the NT631/NT631C. For details, refer to 6-7-2 *Setting the Host Link Method* (page 155).

<sup>\*2</sup> The 1-to-N setting enables BCC (Block Check Character). It is not actually possible to connect more than one NT631/NT631C in a single host link.

Set the CPU Bus Unit settings directly from a Programming Device (e.g. CX-Programmer).

For details on the CPU Bus Unit settings, refer to the *SYSMAC CVM1/CV-series Host Link Unit Operation Manual* (W205-E1-□).

**Setting The Front Switches**

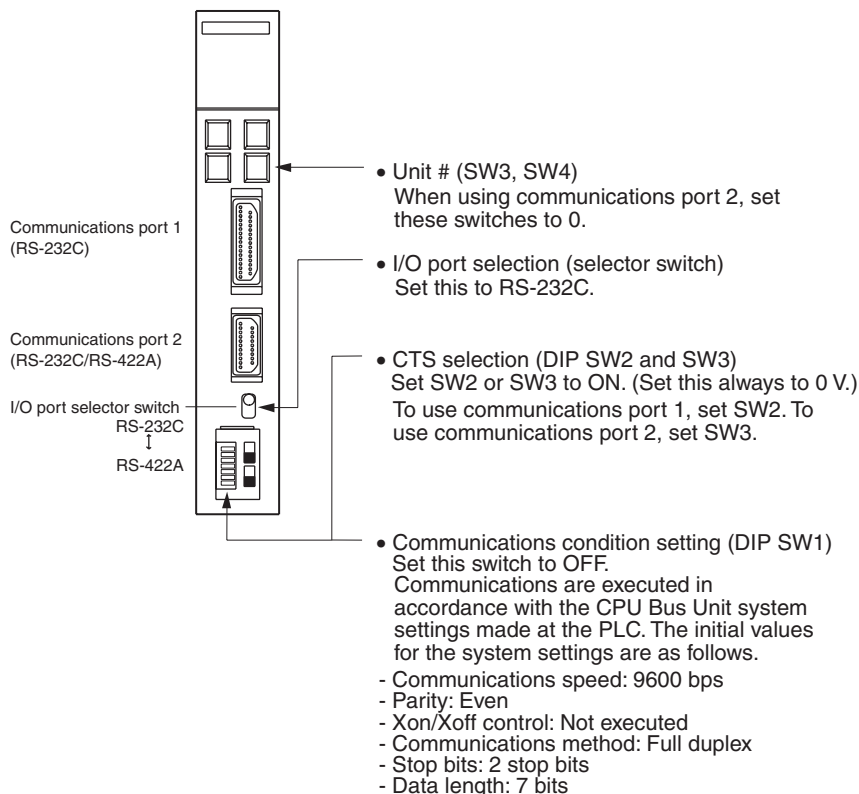

**Connecting to a CPU Unit**

**CV-series and CVM1/CV-series (-EV□) CPU Units**

CV500-CPU01-EV1/CV1000-CPU01-EV1/CV2000-CPU01-EV1  
 CVM1-CPU01-EV2/CVM1-CPU11-EV2/CVM1-CPU21-EV2

**PLC Setup**

When connecting to a CVM1/CV-series CPU Unit, set the following communications conditions for the PLC Setup.

| Item                 | Setting at Host   |
|----------------------|---|
| Communications speed | Set the same speed as set at the NT631/NT631C <sup>(*1)</sup> |
| Stop bit             | 2 stop bits   |
| Parity               | Even  |
| Data length          | ASCII 7 bits  |
| Unit #               | 00  |

\*1 Set the host link communications speed at 9600 bps or 19200 bps with the memory switch at the NT631/NT631C. For details, refer to 6-7-2 *Setting the Host Link Method* (page 155).

Either set PLC Setup directly from a Programming Device (e.g. CX-Programmer), or transmit the PLC Setup made at a Programming Device to the CPU Unit.

For details on the PLC Setup, refer to the *SYSMAC CVM1/CV500/1000/2000 Operation Manual: Ladder Diagrams (W202-E1-□)*.



**Setting the Front Switches**

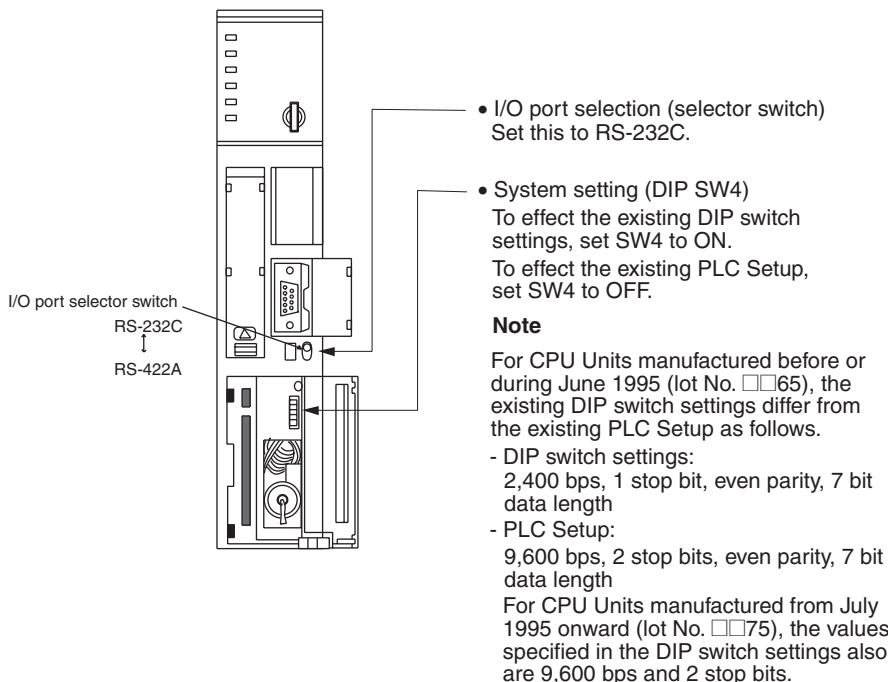

C-series C200HS, C200HX/HG/HE(-Z)E, CPM1, CPM2A, CPM2C, CQM1, CPM1H CPU Units, SRM1

The connection method depends upon the model of PLC being used, as shown in the following table.

| PLC model         | Connection method  |
|-------------------|--|
| C200HS, CQM1      | Connect to the CPU Unit's built-in RS-232C port.   |
| C200HX/HG/HE(-Z)E | Connect to the CPU Unit's built-in RS-232C port.<br>Connect to one of the RS-232C ports (port A or port B) on a Serial Communications Board.   |
| CQM1H             | Connect to the CPU Unit's built-in RS-232C port.<br>Connect to the peripheral port through a CS1W-CN118 Connecting Cable.<br>Connect to the RS-232C port (port 1) on a Serial Communications Board.  |
| CPM1              | Connect to the peripheral port through a CPM1-CIF01 RS-232C Adapter.   |
| CPM2A, SRM1       | Connect to the CPU Unit's built-in RS-232C port.<br>Connect to the peripheral port through a CPM1-CIF01 RS-232C Adapter.   |
| CPM2C             | Connect to the CPU Unit's RS-232C port or the peripheral port through a Connecting Cable (CPM2C-CN111, CS1W-CN118, or CS1W-CN114).<br><br>(The CPM2C-CN111 splits the Unit's Communications Port into a RS-232C port and a peripheral port. A CPM1-CIF01 RS-232C Adapter is also required to connect to this peripheral port.) |

**PLC Setup Area Settings**

When connecting to a C200HS, C200HX/HG/HE(-Z)E, CPM1, CPM2A, CPM2C, CQM1, or CQM1H CPU Unit, or SRM1, set the following communications conditions for the PLC Setup area.

| Item                 | Setting at Host   |
|----------------------|---|
| Communications mode  | Host link mode  |
| Communications speed | Set the same speed as set at the NT631/NT631C <sup>(*1)</sup> |
| Stop bit             | 2 stop bits   |
| Parity               | Even  |
| Data length          | ASCII 7 bits  |
| Unit #               | 00  |

\*1 Set the host link communications speed at 9600 bps or 19200 bps with the memory switch at the NT631/NT631C. For details, refer to 6-7-2 *Setting the Host Link Method* (page 155).

Set the PLC Setup area settings directly from a Programming Device (e.g. CX-Programmer).

For details on operations relating to the PLC Setup area, refer to the manual for the PLC which is used.

The PLC Setup area word numbers and settings to be made depending on the Unit and port to which the connection is made are shown below.

CPM2A, CPM2C, CQM1H, or SRM1: Peripheral port connection

| Word # | Writing Value | Settings  |
|--------|---------------|---|
| DM6650 | 0001          | Host link mode, no CTS control<br>Communications conditions set by the contents of DM |
| DM6651 | 0303          | Data length 7 bits, 2 stop bits, even parity, communications speed: 9600 bps          |
|        | 0304          | Data length 7 bits, 2 stop bits, even parity, communications speed: 19200 bps         |
| DM6653 | 0000          | Unit # 00   |

C200HS, C200HX/HG/HE(-Z)E, CPM2A, CPM2C, CQM1, CQM1H (other than the CPU11), or SRM1: Built-in RS-232C port connection

| Word # | Writing Value | Settings  |
|--------|---------------|---|
| DM6645 | 0001          | Host link mode, no CTS control<br>Communications conditions set by the contents of DM |
| DM6646 | 0303          | Data length 7 bits, 2 stop bits, even parity, communications speed: 9600 bps          |
|        | 0304          | Data length 7 bits, 2 stop bits, even parity, communications speed: 19200 bps         |
| DM6648 | 0000          | Unit # 00   |

C200HX/HG/HE(-Z)E: Serial Communications Board port A

CQM1H: Serial Communications Board port 1

| Word # | Writing Value | Settings  |
|--------|---------------|---|
| DM6555 | 0001          | Host link mode, no CTS control<br>Communications conditions set by the contents of DM |

| Word # | Writing Value | Settings  |
|--------|---------------|---|
| DM6556 | 0303          | Data length 7 bits, 2 stop bits, even parity, communications speed: 9600 bps  |
|        | 0304          | Data length 7 bits, 2 stop bits, even parity, communications speed: 19200 bps |
| DM6558 | 0000          | Unit # 00   |

When using port B of the Communications Board of C200HX/HG/HE(-Z)E

| Word # | Writing Value | Settings  |
|--------|---------------|---|
| DM6550 | 0001          | Host link mode, no CTS control<br>Communications conditions set by the contents of DM |
| DM6551 | 0303          | Data length 7 bits, 2 stop bits, even parity, communications speed: 9600 bps          |
|        | 0304          | Data length 7 bits, 2 stop bits, even parity, communications speed: 19200 bps         |
| DM6553 | 0000          | Unit # 00   |

When using a CPM1

| Word # | Writing Value | Settings  |
|--------|---------------|---|
| DM6650 | 0001          | Host link mode<br>Communications conditions set by the contents of DM         |
| DM6651 | 0303          | Data length 7 bits, 2 stop bits, even parity, communications speed: 9600 bps  |
|        | 0304          | Data length 7 bits, 2 stop bits, even parity, communications speed: 19200 bps |
| DM6653 | 0000          | Unit # 00   |

**Connecting to a CPM2C**

The CPM2C PLCs do not have the same kind of port connectors found on CS/CJ-series PLCs. The CPM2C's communications port handles both RS-232C and peripheral port connections which are divided internally. Therefore, when using the CPM2C, it is necessary to select RS-232C or peripheral port connections, according to the kind of cable and port (on the cable) used, as shown in the following table. Refer to the *CPM2C Operation Manual* for more details.

| Port connecting to PT                     | PLC Setup                      |
|---|--------------------------------|
| RS-232C port (D-Sub 9-pin) of CPM2C-CN111 | Built-in RS-232C port settings |
| Peripheral port of CPM2C-CN111            | Peripheral port settings       |
| RS-232C port (D-Sub 9-pin) of CS1W-CN118  | Built-in RS-232C port settings |
| Peripheral port of CS1W-CN114             | Peripheral port settings       |

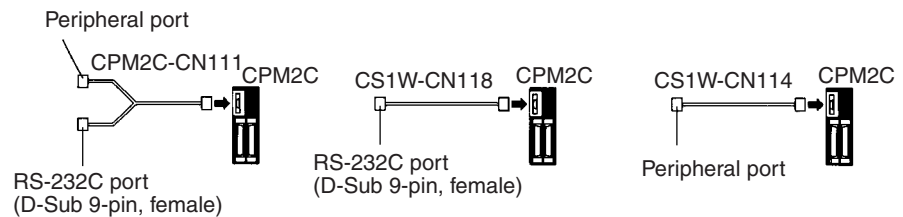

**Setting the DIP Switches of a C200HX/HG/HE(-Z)E, CQM1 or CQM1H**

When using a C200HX/HG/HE(-Z)E, CQM1, or CQM1H the DIP switches on the front panel must be set as shown below in order to make the settings in the PLC Setup area (data memory) effective.

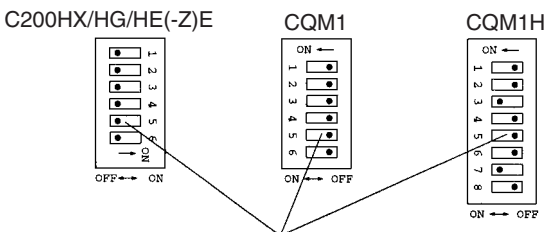

RS-232C port communications condition setting  
Set DIP SW5 to OFF to make the settings made in PC Setup effective.

When using the CQM1H's built-in peripheral port, turn ON SW7.

**Setting the Switches of a CPM2A**

When using a CPM2A, the switches on the front panel must be set as shown below in order to make the PLC Setup settings effective.

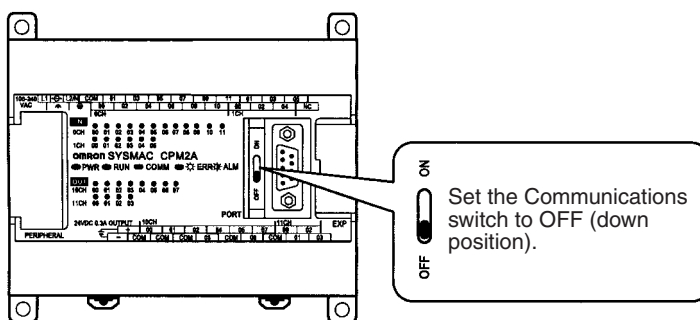

**Setting the Switches of a CPM2C**

When using a CPM2C, the switches on the front panel must be set as shown below in order to make the PLC Setup settings effective.

The settings for SW1 and SW2 depend upon the usage of the peripheral port and RS-232C port.

- Connecting PT to peripheral port
- Connecting PT to built-in RS-232C port  
(A device that requires non-standard communications settings is connected to the peripheral port.)

SW1: OFF  
SW2: ON

- Connecting PT to built-in RS-232C port  
(A Programming Console is connected to the peripheral port.)

SW1: OFF  
SW2: OFF

**Setting the Switches on a RS-232C Adapter**

When using a CPM1-CIF01 RS-232C Adapter, set the mode switch as shown in the following diagram.

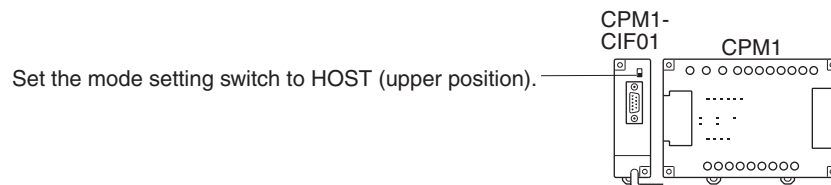

CS/CJ-series CPU Unit: CS1G/H-CPU□□-E(V1), CS1G/H/D-CPU□□H  
 CJ1G/M-CPU□□, CJ1G/H-CPU□□H

Connect to the built-in RS-232C port of the CPU Unit, or the RS-232C port of the Communications Board. Note that the connection to a peripheral port must be made via an RS-232C adapter (CS1W-CN118) specially designed for connecting to a peripheral port.

**PLC Setup**

When connecting to a CS/CJ-series CPU Unit, set the following communications conditions for the PLC Setup area. Since the settings shown below are the PLC default settings for the CPU Unit, no change to the PLC Setup is necessary as long as the communications speed is maintained at 9600 bps.

| Item                       | Setting at Host                                   |
|----------------------------|---|
| Communications speed       | Set the same speed as set at the NT631/NT631C(*1) |
| Stop bits                  | 2 stop bits                                       |
| Parity                     | Even  |
| Data length                | ASCII 7 bits                                      |
| Unit No. for the host link | 00  |

\*1 Set the host link communications speed at 9600 bps or 19200 bps with the memory switch at the NT631/NT631C. For details, refer to 6-7-2 *Setting the Host Link Method* (page 155).

When the communications speed is set to 19200 bps., the PLC Setup of the CPU Unit need to be changed.

Either set the PLC Setup directly from a Programming Device (Programming Console), or transmit the PLC Setup made at a Programming Device (CX-Programmer) to the CPU Unit.

For details on the PLC Setup, refer to the *SYSMAC CS Series Operation Manual* (W339) or the *SYSMAC CJ Series Operation Manual* (W393).

Using the CPU Unit's Built-in RS-232C Port

| Word # | Writing Value | Settings   |
|--------|---------------|--|
| 160    | 8000          | Host link mode, data length 7 bits, 2 stop bits, even parity |
| 161    | 0000          | Communications speed: 9600 bps.                              |
|        | 0007          | Communications speed: 19200 bps.                             |
| 166    | 0000          | Unit #00   |

Using the CPU Unit's Peripheral Port

| Word # | Writing Value | Settings   |
|--------|---------------|--|
| 144    | 8000          | Host link mode, data length 7 bits, 2 stop bits, even parity |
| 145    | 0000          | Communications speed: 9600 bps.                              |
|        | 0007          | Communications speed: 19200 bps.                             |
| 150    | 0000          | Unit #00   |

**Setting the Front Switches**

Set the CPU Unit's DIP switches to 4 or 5 in accordance with the port NT631/NT631C is connected to. An example of a CS-series CPU Unit is shown below.

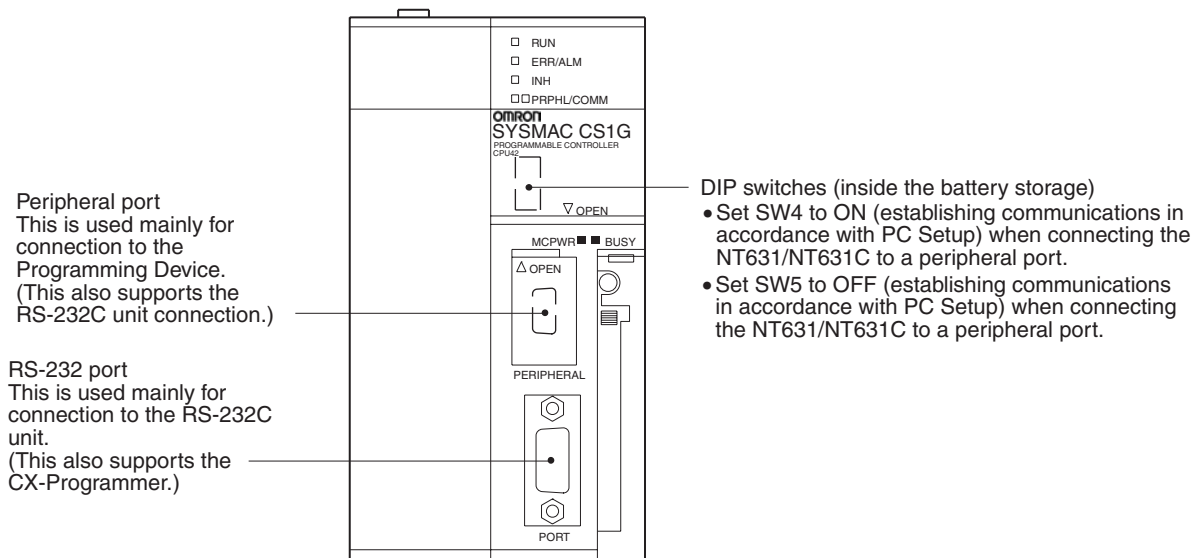

**Connecting to CS-series Serial Communications Board**

Serial Communications Board equipped with a RS-232C port for CS-series CPU Units: CS1W-SCB21(-V1)/41(-V1) (See note.)

**Note** Cannot be used with the CS1D-CPU65H/67H.

**Allocation DM Area Settings for CPU Unit**

Settings are written from the Programming Device (a Programming Console or CX-Programmer) directly into the allocation DM area (system setting area) of the CPU Unit. After the settings are written, they become effective by turning the power ON, restarting the Unit, restarting the communications port, or execution of the STUP command.

In the following, the channel numbers of the allocation DM area and the settings are shown.

| Allocation DM area (words) |         | Writing Value | Settings   |
|----------------------------|---------|---------------|--|
| Port 1                     | Port 2  |               |  |
| DM32000                    | DM32010 | 8000          | Host link mode, 2 stop bits, even parity, data length 7 bits |
| DM32001                    | DM32011 | 0000          | Communications speed 9600 bps.                               |
|                            |         | 0007          | Communications speed 19200 bps.                              |
| DM32002                    | DM32012 | 0000          | Transmit delay time 0 ms.                                    |
| DM32003                    | DM32013 | 0000          | No CTS control Unit No.0 for host link                       |

**Connecting to a CS/CJ-series Serial Communications Unit**

**CS/CJ-series Rack-mounting Unit:**

- CS1W-SCU21(-V1)
- CJ1W-SCU21(-V1)/41(-V1)

**Setting the Front-panel Switches**

Set the unit number of the Serial Communications Unit by using the rotary switch located on the front panel. Set each switch with a flat blade screwdriver so that the values or symbols in the setting value window agree with the following.

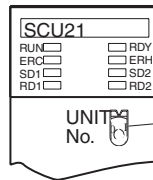

Set the unit number to 0 through F so that it will not overlap with the numbers used in other units.

**Allocation DM Area Settings for CPU Unit**

Settings are written from the Programming Device (a Programming Console or CX-Programmer) directly into the allocation DM area (system setting area) of the CPU Unit. After the settings are written, they become effective by turning the power ON, restarting the Unit, restarting the communications port, or execution of the STUP command.

In the following, the channel numbers of the allocation DM area and the settings are shown.

$$m = DM30000 + 100 \times \text{unit \# (CH)}$$

| Allocation DM area (CH) |        | Writing Value | Settings   |
|-------------------------|--------|---------------|--|
| Port 1                  | Port 2 |               |  |
| m                       | m+10   | 8000          | Host link mode, 2 stop bits, even parity, data length 7 bits |
| m+1                     | m+11   | 0000          | Communications speed 9600 bps.                               |
|                         |        | 0007          | Communications speed 19200 bps.                              |
| m+2                     | m+12   | 0000          | Transmit delay time 0 ms.                                    |
| m+3                     | m+13   | 0000          | No CTS control Unit No.0 for host link                       |

**When Using the NT Link (1:1) Method**

**Compatible Host Units**

Some models and series of OMRON PLCs have the NT link (1:1) function built in. With CQM1H PLCs, a Serial Communications Board can be added to provide 1:1 NT Link communications. Some C200HX/HG/HE(-Z)E CPU Units can be connected by the NT link (1:1) method by installing a Communications Board.

Check the model and series of the PLC against the type of CPU Unit before making the connections.

The hosts that can be connected to the NT631/NT631C by the NT Link (1:1) method using the RS-232C ports of both Units are indicated in the table below.

| PLC Series | CPU Units with Built-in NT Link Function   | CPU Units Connectable with Expansion Communications Board <sup>(*1)</sup>  | Connectable to |
|------------|--|--|----------------|
| C Series   | C200HS-CPU21-E, -EC<br>C200HS-CPU23-E<br>C200HS-CPU31-E<br>C200HS-CPU33-E  |  | C200HS         |
|            | C200HE-CPU42-(Z)E  | C200HE-CPU32-(Z)E<br>C200HE-CPU42-(Z)E   | C200HE (-ZE)   |
|            | C200HG-CPU43-(Z)E<br>C200HG-CPU63-(Z)E   | C200HG-CPU33-(Z)E<br>C200HG-CPU43-(Z)E<br>C200HG-CPU53-(Z)E<br>C200HG-CPU63-(Z)E                                       | C200HG (-ZE)   |
|            | C200HX-CPU44-(Z)E<br>C200HX-CPU64-(Z)E<br>X200HX-CPU65-ZE<br>C200HX-CPU85-ZE   | C200HX-CPU34-(Z)E<br>C200HX-CPU44-(Z)E<br>C200HX-CPU54-(Z)E<br>C200HX-CPU64-(Z)E<br>C200HX-CPU65-ZE<br>C200HX-CPU85-ZE | C200HX (-ZE)   |
|            | CPM1-10CDR-□ <sup>(*2)</sup><br>CPM1-20CDR-□ <sup>(*2)</sup><br>CPM1-30CDR-□ <sup>(*2)</sup><br>CPM1A-10CD□-□ <sup>(*2)</sup><br>CPM1A-20CD□-□ <sup>(*2)</sup><br>CPM1A-30CD□-□ <sup>(*2)</sup><br>CPM1A-40CD□-□ <sup>(*2)</sup> |  | CPM1           |
|            | CPM2A-30CD□□-□<br>CPM2A-40CD□□-□<br>CPM2A-60CD□□-□   |  | CPM2A          |
|            | CPM2C-10□□□□□□-□ <sup>(*3)</sup><br>CPM2C-20□□□□□□-□   |  | CPM2C          |
|            | CQM1-CPU41-EV1<br>CQM1-CPU42-EV1<br>CQM1-CPU43-EV1<br>CQM1-CPU44-EV1<br>CQM1-CPU45-EV1   |  | CQM1           |
|            | CQM1H-CPU21<br>CQM1H-CPU51<br>CQM1H-CPU61  | CQM1H-CPU51 <sup>(*4)</sup><br>CQM1H-CPU61 <sup>(*4)</sup>   | CQM1H          |
|            | CV Series <sup>(*5)</sup>  | CV500-CPU01-EV1<br>CV1000-CPU01-EV1<br>CV2000-CPU01-EV1  |                |



| PLC Series                     | CPU Units with Built-in NT Link Function           | CPU Units Connectable with Expansion Communications Board <sup>(*1)</sup> | Connectable to |
|--------------------------------|--|---|----------------|
| CVM1 Series <sup>(*5)</sup>    | CVM1-CPU01-EV2<br>CVM1-CPU11-EV2<br>CVM1-CPU21-EV2 |   | CVM1           |
| CompoBus/S Master Control Unit | SRM1-C02-V1  |   | SRM1           |

<sup>\*1</sup> One of the following Communications Boards is required: C200HW-COM02/COM04/COM05/COM06-EV1.

<sup>\*2</sup> A CPM1-CIF01 Adapter is required.

<sup>\*3</sup> Use a CPM2C-CN111 or CS1W-CN114/118 Connecting Cable, CPM1-CIF01 RS-232C Adapter, or CPM1-CIF11 RS-422A Adapter to connect.

<sup>\*4</sup> A CQM1H-SCB41 Serial Communications Board is required.

<sup>\*5</sup> CPU Units of CVM1/CV-series PLCs without the suffix -EV□ cannot be connected.

**Reference:** CS/CJ-series CPU Units cannot be connected with the 1:1 connection NT link method. Use the 1:N connection NT link method (standard or high-speed) instead to make the 1:1 connection. For details, refer to *Using the NT Link (1:N) Method* (page 65) or *Using the High-speed NT Link (1:N) Method* (page 70).

**Settings at the Host**

The setting methods for each Unit are as follows.

**Connecting to a C-series C200HS, C200HX/HG/HE(-Z)E, CPM1, CPM2A, CPM2C, CQM1, CQM1H or SRM1 PLC**

**PLC Setup Area Settings**

Write the PLC Setup area (data memory) settings directly from a Programming Device (e.g. CX-Programmer) in accordance with the host model and port.

| Host Model   | Word # | Writing Value | Setting           |
|--|--------|---------------|-------------------|
| RS-232C port of C200HS, C200HX/HG/HE(-Z)E, CPM2A, CPM2C, CQM1, CQM1H, SRM1     | DM6645 | 4000          | Use NT link (1:1) |
| Port A of C200HX/HG/HE(-Z)E <sup>(*1)</sup><br>Port 1 of CQM1H <sup>(*2)</sup> | DM6555 |               |                   |
| Port B of C200HX/HG/HE(-Z)E <sup>(*1)</sup>                                    | DM6550 |               |                   |
| CPM1   | DM6650 |               |                   |

<sup>\*1</sup> RS-232C port of the Communications Board

<sup>\*2</sup> RS-232C port of the Serial Communications Board

For details on operations relating to the PLC Setup area, refer to the manual for the PLC which is used.

**Connecting to a CPM2C**

The CPM2C PLCs do not have the same kind of port connectors found on CS/CJ-series PLCs. The CPM2C's communications port handles both RS-232C and peripheral port connections which are divided internally. Therefore, when using the CPM2C, it is necessary to select RS-232C or peripheral port connections, according to the kind of cable and port (on the cable) used, as shown in the following table. Refer to the *CPM2C Operation Manual* for more details.

| Port connecting to PT                     | PLC Setup                      |
|---|--------------------------------|
| RS-232C port (D-Sub 9-pin) of CPM2C-CN111 | Built-in RS-232C port settings |
| Peripheral port of CPM2C-CN111            | Peripheral port settings       |
| RS-232C port (D-Sub 9-pin) of CS1W-CN118  | Built-in RS-232C port settings |
| Peripheral port of CS1W-CN114             | Peripheral port settings       |

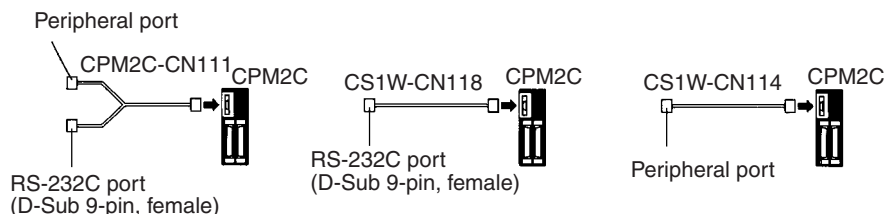

**Setting the DIP Switches of a C200HX/HG/HE(-Z)E, CQM1, or CQM1H**

When using a C200HX/HG/HE(-Z)E, CQM1, or CQM1H, the DIP switches on the front panel must be set as shown below in order to make the settings in the PLC Setup area (data memory) effective.

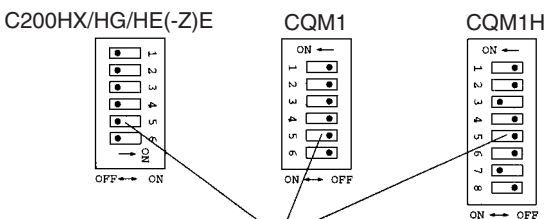

RS-232C port communications condition setting  
Set DIP SW5 to OFF to make the settings made in PLC Setup effective.

**Setting the Switches of a CPM2A**

When using a CPM2A, the switches on the front panel must be set as shown below in order to make the PLC Setup settings effective.

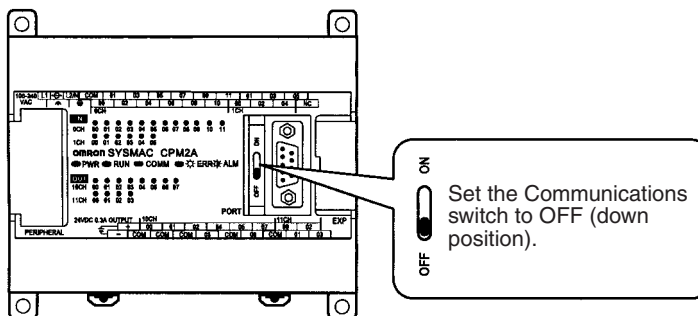

**Setting the Switches of a CPM2C**

When using a CPM2C, the switches on the front panel must be set as shown below in order to make the PLC Setup settings effective.

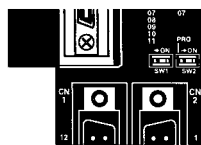

The settings for SW1 and SW2 depend upon the usage of the peripheral port and RS-232C port.

- Connecting PT to peripheral port
- Connecting PT to built-in RS-232C port  
(A device that requires non-standard communications settings is connected to the peripheral port.)

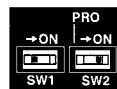

SW1: OFF  
SW2: ON

- Connecting PT to built-in RS-232C port  
(A Programming Console is connected to the peripheral port.)

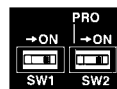

SW1: OFF  
SW2: OFF

**Setting the Switches on an RS-232C Adapter**

When using a CPM1-CIF01 RS-232C Adapter, set the mode switch as shown in the following diagram.

Set the mode setting switch to NT (lower position).

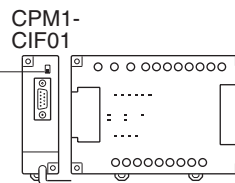

**Connecting to CVM1/CV Series (-EV□)**

Set the DIP switches on the front panel as follows.

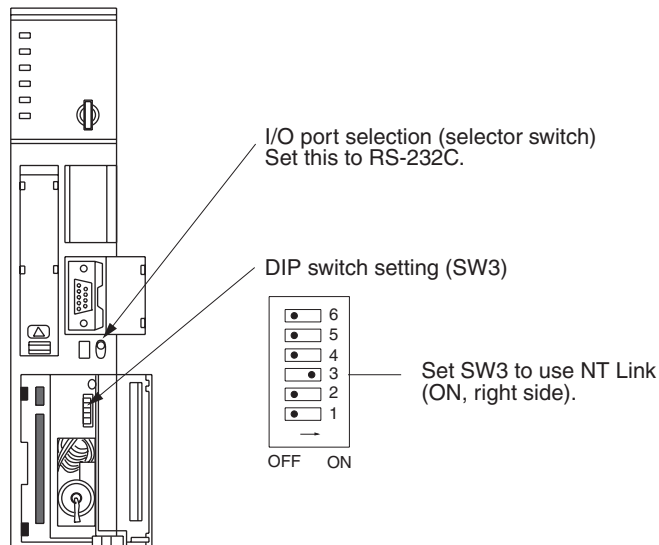

When using a CVM1/CV-series PLC, CPU Unit execution processing (execution control 2) in the PLC Setup must be set to Simultaneous processing.

**Using the NT Link (1:N) Method**

**Compatible Host Units**

The OMRON PLCs that can be connected using the NT link (1:N) method are the CS/CJ-series CPU Units and the C-series C200HX/HG/HE(-Z)E, CQM1H, and SRM1 only. With the CS/CJ-series PLCs, it is possible to connect a 1:N NT Link using a Serial Communications Board (CS Series only) or a Serial Communications Unit.

Check the model and series of the PLC as well as the model of Serial Communications Board or Unit being used before making the connections.

The hosts that can be connected to the NT631/NT631C by the NT link (1:N) method using the RS-232C ports of both Units are indicated in the table below.

| PLC Series                     | CPU Units with Built-in NT Link Function   | CPU Units Connectable with Communications Board/Unit   | Connectable to       |
|--------------------------------|--|--|----------------------|
| CS Series                      | CS1G-CPU42/43/44/45-E(V1)<br>CS1H-CPU63/64/65/66/67-E(V1)<br>CS1G-CPU42H/43H/44H/45H<br>CS1H-CPU63H/64H/65H/66H/67H<br>CS1D-CPU65H/67H | CS1G-CPU42/43/44/45-E(V1) <sup>(*1)</sup><br>CS1H-CPU63/64/65/66/67-E(V1) <sup>(*1)</sup><br>CS1G-CPU42H/43H/44H/45H <sup>(*1)</sup><br>CS1H-CPU63H/64H/65H/66H/67H <sup>(*1)</sup><br>CS1D-CPU65H/67H <sup>(*2)</sup> | CS1G<br>CS1H<br>CS1D |
| CJ Series                      | CJ1G-CPU44/45<br>CJ1G-CPU42H/43H/44H/45H<br>CJ1H-CPU65H/66H/67H<br>CJ1M-CPU11/12/13/21/22/23   | CJ1G-CPU44/45 <sup>(*3)</sup><br>CJ1G-CPU42H/43H/44H/45H <sup>(*3)</sup><br>CJ1H-CPU65H/66H/67H <sup>(*3)</sup><br>CJ1M-CPU11/12/13/21/22/23 <sup>(*3)</sup>   | CJ1G<br>CJ1H<br>CJ1M |
| C Series                       | C200HE-CPU42-(Z)E  | C200HE-CPU32-(Z)E <sup>(*4)</sup><br>C200HE-CPU42-(Z)E <sup>(*4)</sup>   | C200HE (-Z)E         |
|                                | C200HG-CPU43-(Z)E<br>C200HG-CPU63-(Z)E   | C200HG-CPU33-(Z)E <sup>(*4)</sup><br>C200HG-CPU43-(Z)E <sup>(*4)</sup><br>C200HG-CPU53-(Z)E <sup>(*4)</sup><br>C200HG-CPU63-(Z)E <sup>(*4)</sup>   | C200HG (-Z)E         |
|                                | C200HX-CPU44-(Z)E<br>C200HX-CPU64-(Z)E<br>C200HX-CPU65-ZE<br>C200HX-CPU85-ZE   | C200HX-CPU34-(Z)E <sup>(*4)</sup><br>C200HX-CPU44-(Z)E <sup>(*4)</sup><br>C200HX-CPU54-(Z)E <sup>(*4)</sup><br>C200HX-CPU64-(Z)E <sup>(*4)</sup><br>C200HX-CPU65-ZE <sup>(*4)</sup><br>C200HX-CPU85-ZE <sup>(*4)</sup> | C200HX (-Z)E         |
|                                | ---  | CQM1H-CPU51 <sup>(*5)</sup><br>CQM1H-CPU61 <sup>(*5)</sup>   | CQM1H                |
| CompoBus/S Master Control Unit | SRM1-C02-V2  | ---  | SRM1                 |

\*1 A CS1W-SCB21(-V1) or CS1W-SCB41(-V1) Serial Communications Board or CS1W-SCU21(-V1) Serial Communications Unit is required.

\*2 A CS1W-SCU21(-V1) Serial Communications Unit is required. A CS1W-SCB21/41(-V1) Serial Communications Board cannot be used.

\*3 One of the following Communications Units is required:  
CJ1W-SCU21/41(-V1).

\*4 One of the following Communications Boards is required:  
C200HW-COM02/COM04/COM05/COM06-E(V1)

\*5 A CQM1H-SCB41 Serial Communications Board is required.

**Reference:** Version 1 (-V1) and high-speed versions (H) of the CS-series and CJ-series CPU Units support the high-speed 1:N NT Link method in addition to the standard 1:N NT Link method. Furthermore, the high-speed 1:N NT Link method can be used in earlier versions of CS-series CPU Units by installing the latest version of a Serial Communications Board or Unit. For details, refer to *Using the High-speed NT Link (1:N) Method* (page 70).

**Settings at the Host**

The Settings required for each Unit are described below.

- Connecting a C-series C200HX/HG/HE(-Z)E, CQM1H, or SRM1

**PLC Setup Area Settings**

Write the PLC Setup area (data memory) settings directly from a Programming Device (e.g. CX-Programmer) in accordance with the host model and port.

| Connection to  | Word # | Writing Value | Setting   |
|--|--------|---------------|---|
| C200HX/HG/HE(-Z)E, SRM1<br>Built-in RS-232C port                     | DM6645 | 5□00          | Use NT link (1:N)<br>□ = highest unit number of the connected PTs (1 to 7) (*3) |
| C200HX/HG/HE(-Z)E<br>Communications Board port A*1<br>CQM1H port 1*2 | DM6555 |               |   |
| C200HX/HG/HE(-Z)E<br>Communications Board port B*1                   | DM6550 |               |   |

\*1 RS-232C port on the Communications Board

\*2 RS-232C port on the Serial Communications Board

\*3 When using a C200HE(-Z)E, the maximum PT unit number is 3.

Refer to the PLC's operation manual for details on changing PLC Setup settings.

**Setting the DIP Switches of a C200HX/HG/HE(-Z)E**

When using a C200HX/HG/HE(-Z)E, the DIP switches on the front panel must be set as shown below in order to make the settings in the PLC Setup area (data memory) effective.

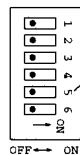

RS-232C port communications condition setting  
Set DIP SW5 to OFF to make the settings made in PLC Setup effective.

Connecting to CS/CJ-series CPU Units

CS/CJ-series CPU Unit: CS1G/H-CPU□□-E(V1), CS1G/H/D-CPU□□H,  
CJ1G/M-CPU□□, CJ1G/H-CPU□□H

Connect the PT to the CPU Unit's built-in RS-232C port. Use a CS1W-CN118 Connecting Cable, however, if connecting the PT to the peripheral port of the CPU Unit.

**PLC Setup Area Settings**

When connecting to a CS/CJ-series CPU Unit, set the following communications conditions for the PLC Setup area, in accordance with the communications port to be used.

Using the CPU Unit's Built-in RS-232C Port

| Word # | Writing Value     | Settings   |
|--------|-------------------|--|
| 160    | 8200              | NT link (1:N) mode                                       |
| 161    | 0000 to 0009 (*1) | Communications baud rate (standard)                      |
| 166    | 000□              | □ = The largest model number of the connected PT (0 – 7) |

\*1 Set any value between 0000 and 0009 Hex for the communications baud rate. The same baud rate will be used regardless of the value as long as it is between 0000 and 0009 Hex.

Using the CPU Unit's Peripheral Port

| Word # | Writing Value     | Settings   |
|--------|-------------------|--|
| 144    | 8200              | NT link (1:N) mode                                       |
| 145    | 0000 to 0009 (*1) | Communications baud rate (standard)                      |
| 150    | 000□              | □ = The largest model number of the connected PT (0 – 7) |

\*1 Set any value between 0000 and 0009 Hex for the communications baud rate. The same baud rate will be used regardless of the value as long as it is between 0000 and 0009 Hex.

When connecting PT with its model number 0, 2-5 to the built-in RS-232C port, for example, set the value 8200 Hex to 160 CH, and 0005 Hex to 166CH.

Either set PLC Setup directly from a Programming Device (Programming Console), or transmit the PLC Setup made at a Programming Device (CX-Programmer) to the CPU Unit.

For details on the PLC Setup, refer to the *SYSMAC CS Series Operation Manual (W339)* or the *SYSMAC CJ Series Operation Manual (W393)*.

**Setting the Front Switches**

Set the CPU Unit's DIP switch to 4 or 5 in accordance with the port NT631/NT631C is connected to. An example of a CS-series CPU Unit is shown below.

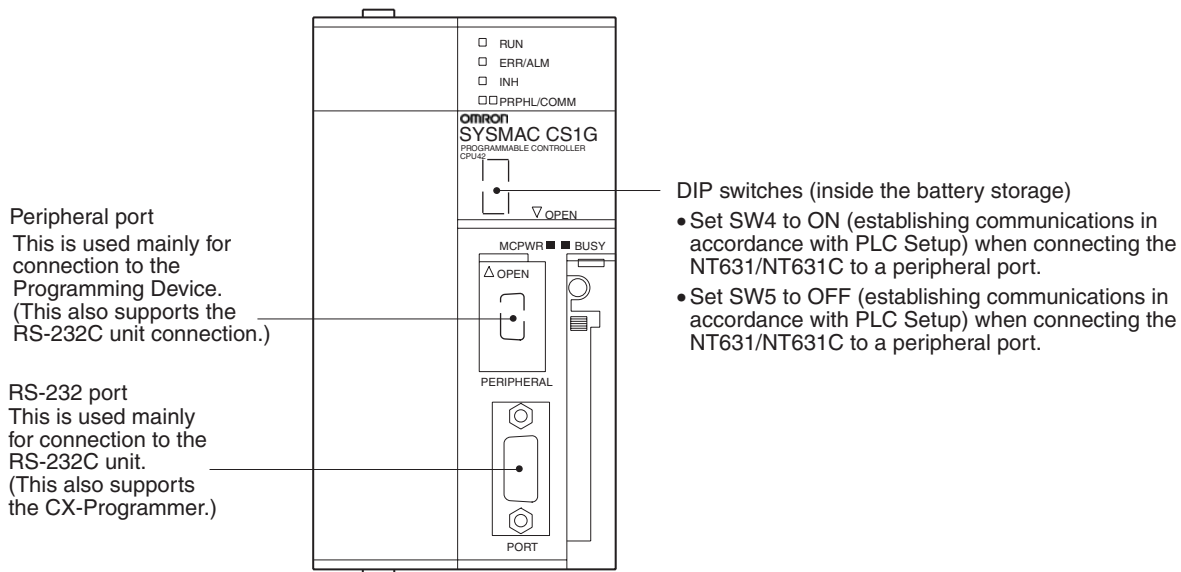

**Connecting to CS-series Serial Communications Board**

Serial Communications Board equipped with a RS-232C port for CS1-series CPU Units: CS1W-SCB21(-V1)/41(-V1) (See note.)

**Note** Cannot be used with the CS1D-CPU65H/67H.

**CPU Unit Allocation DM Area Settings**

Setting is written from the Programming Device (a Programming Console or CX-Programmer) directly into the allocation DM area (system setting area) of the CPU Unit. After the setting is written, it becomes effective by turning the power ON, restarting the Unit, restarting the communications port, or execution of the STUP command.

In the following, the channel numbers of the allocation DM area and settings are shown.

| Allocated DM Area words |         | Setting           | Setting Contents  |
|-------------------------|---------|-------------------|---|
| Port 1                  | Port 2  |                   |   |
| DM32000                 | DM32010 | 8200              | 1:N NT Link Mode  |
| DM32001                 | DM32011 | 0000 to 0009 (*1) | Baud rate (standard)                                      |
| DM32006                 | DM32016 | 000□              | □ = The highest unit number of the connected PTs (0 to 7) |

\*1 Set any value between 0000 and 0009 hex for the baud rate. The same baud rate will be used regardless of the value as long as it is between 0000 and 0009 hex.

When connecting PTs with model numbers 3 to 6 to port 1, for example, set the value 8200 hex to DM32000, 0000 hex to DM32001, and 0006 hex to DM32006.

**Connecting to CS/CJ-series Serial Communications Unit**

A CS/CJ-series Rack-mounting Unit: CS1W-SCU21,  
CJ1W-SCU21(-V1)/41(-V1)

**Setting the Front Switches**

Set the unit number of the Serial Communications Unit by using the rotary switch located on the front panel. Set each switch with a flat blade screwdriver so that the values or symbols in the setting value window agree with the following.

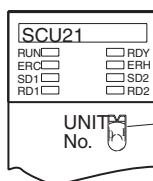

Set the unit number to 0 through F so that it will not overlap with the numbers used in other units.

**Allocation DM Area Settings for CPU Unit**

Setting is written from the Programming Device (a Programming Console or CX-Programmer) directly into the allocation DM area (system setting area) of the CPU Unit. After the setting is written, it becomes effective by turning the power ON, restarting the Unit, restarting the communications port, or execution of the STUP command.

In the following, the channel numbers of the allocation DM area and settings are shown.

$$m = \text{DM30000} + 100 * \text{unit number (CH)}$$

| Allocated DM Area words |        | Setting           | Setting Contents  |
|-------------------------|--------|-------------------|---|
| Port 1                  | Port 2 |                   |   |
| m                       | m+10   | 8200              | 1:N NT Link Mode  |
| m+1                     | m+11   | 0000 to 0009 (*1) | Baud rate (standard)                                      |
| m+6                     | m+16   | 000□              | □ = The highest unit number of the connected PTs (0 to 7) |

\*1 Set any value between 0000 and 0009 hex for the baud rate. The same baud rate will be used regardless of the value as long as it is between 0000 and 0009 hex.

**Using the High-speed NT Link (1:N) Method**

**Compatible Host Units**

The high-speed 1:N NT Link method can be used with version 1 (-V1) and high-speed versions (H) of the CS-series and CJ-series CPU Units. Furthermore, the high-speed 1:N NT Link method can be used in earlier versions of CS-series and CJ-series CPU Units by installing the latest version of a Serial Communications Board (CS Series only) or Serial Communications Unit.

Be sure to check the model number of the PLC and Serial Communications Board/Unit before trying to establish the high-speed 1:N NT Link.

The following table shows which CS-series PLCs can be connected to an NT631/NT631C with the high-speed 1:N NT Link.

| PLC Series | CPU Units with Built-in NT Link Function   | CPU Units Connectable with Communications Board/Unit   | Connectable to       |
|------------|--|--|----------------------|
| CS Series  | CS1G-CPU42/43/44/45-EV1 <sup>(*1)</sup><br>CS1H-CPU63/64/65/66/67-EV1 <sup>(*1)</sup><br>CS1G-CPU42H/43H/44H/45H<br>CS1H-CPU63H/64H/65H/66H/67H<br>CS1D-CPU65H/67H | CS1G-CPU42/43/44/45-E(V1) <sup>(*2)</sup><br>CS1H-CPU63/64/65/66/67-E(V1) <sup>(*2)</sup><br>CS1G-CPU42H/43H/44H/45H <sup>(*2)</sup><br>CS1H-CPU63H/64H/65H/66H/67H <sup>(*2)</sup><br>CS1D-CPU65H/67H <sup>(*3)</sup> | CS1G<br>CS1H<br>CS1D |
| CJ Series  | CJ1G-CPU44/45<br>CJ1G-CPU42H/43H/44H/45H<br>CJ1H-CPU65H/66H/67H<br>CJ1M-CPU11/12/13/21/22/23   | CJ1G-CPU44/45 <sup>(*4)</sup><br>CJ1G-CPU42H/43H/44H/45H <sup>(*4)</sup><br>CJ1H-CPU65H/66H/67H <sup>(*4)</sup><br>CJ1M-CPU11/12/13/21/22/23 <sup>(*4)</sup>   | CJ1G<br>CJ1H<br>CJ1M |

\*1 The high-speed 1:N NT Link is not supported in a direct connection to the CPU Unit of a CS1-series PLC without the -V1 suffix.

\*2 A CS1W-SCB21 or CS1W-SCB41(-V1) Serial Communications Board or CS1W-SCU21(-V1) Serial Communications Unit is required.

\*3 A CS1W-SCU21(-V1) Serial Communications Unit is required. A CS1W-SCB21/41(-V1) Serial Communications Board cannot be used.

\*4 One of the following Communications Units is required: CJ1W-SCU21/41(-V1).

**Settings at the Host**

The Settings required for each Unit are described below.

• **Connecting CS/CJ-series CPU Units**

CS/CJ-series CPU Unit: CS1G/H-CPU□□-EV1, CS1G/H/D-CPU□□H-E, CJ1G/M-CPU□□-E, CJ1GH-CPU□□H-E

Connect the PT to the CPU Unit's built-in RS-232C port. Use a CS1W-CN118 Connecting Cable, however, if connecting the PT to the peripheral port of the CPU Unit.

**PLC Setup**

When connecting to a CS-series CPU Unit, set the following communications conditions for the PLC Setup area, in accordance with the communications port to be used.



Using the CPU Unit's Built-in RS-232C Port

| Word # | Setting | Setting Contents  |
|--------|---------|---|
| 160    | 8200    | 1:N NT Link Mode  |
| 161    | 000A    | Baud rate (standard)                                      |
| 166    | 000□    | □ = The highest unit number of the connected PTs (0 to 7) |

Using the CPU Unit's Peripheral Port

| Word # | Setting | Setting Contents  |
|--------|---------|---|
| 144    | 8200    | 1:N NT Link Mode  |
| 145    | 000A    | Baud rate (standard)                                      |
| 150    | 000□    | □ = The highest unit number of the connected PTs (0 to 7) |

When connecting PTs with model numbers 0, 2, 3, 4, and 5 to the built-in RS-232C port, for example, set the value 8200 hex to word 160, 000A hex to word 161, and 0005 hex to word 166.

Either set PLC Setup directly from a Programming Device (Programming Console), or transmit the PLC Setup made at a Programming Device (CX-Programmer) to the CPU Unit.

For details on the PLC Setup, refer to the *SYSMAC CS Series Operation Manual (W339)* or the *SYSMAC CJ Series Operation Manual (W393)*.

**Reference:** When using the CX-Programmer to set the high-speed 1:N NT Link, set the communications baud rate to 115,200 bps.

**Setting The Front Switches**

Set the CPU Unit's DIP switch to 4 or 5 in accordance with the port NT631/NT631C is connected to. An example of a CS-series CPU Unit is shown below.

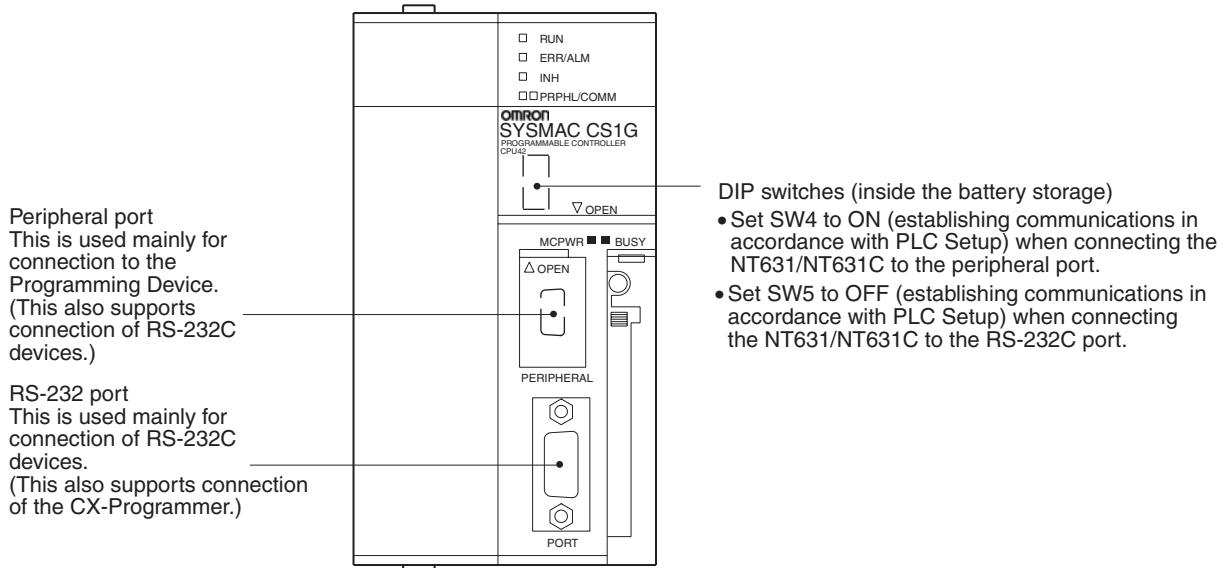

**Connecting to a CS-series Serial Communications Board**

Serial Communications Board equipped with a RS-232C port for CS-series CPU Units: CS1W-SCB21(-V1)/41(-V1)

**Note** Cannot be used with the CS1D-CPU65H/67H.

**Reference:** CS-series Serial Communications Boards and Units with lot number 991220 (12/20/99) and later support the high-speed 1:N NT Link. Boards and Units with earlier lot numbers **cannot** be used.

**CPU Unit Allocation DM Area Settings**

Setting is written from the Programming Device (a Programming Console or CX-Programmer) directly into the allocation DM area (system setting area) of the CPU Unit. After the setting is written, it becomes effective by turning the power ON, restarting the Unit, restarting the communications port, or execution of the STUP command.

In the following, the channel numbers of the allocation DM area and settings are shown.

| Allocated DM Area words |         | Setting | Setting Contents  |
|-------------------------|---------|---------|---|
| Port 1                  | Port 2  |         |   |
| DM32000                 | DM32010 | 8200    | 1:N NT Link Mode  |
| DM32001                 | DM32011 | 000A    | Baud rate (standard)                                      |
| DM32006                 | DM32016 | 000□    | □ = The highest unit number of the connected PTs (0 to 7) |

For example, when connecting PTs with model numbers 3, 4, 5, and 6 to port 1, set the value 8200 hex to DM32000, 000A hex to DM32001, and 0006 hex to DM32006.

**Connecting to a CS/CJ-series Serial Communications Unit**

A CS/CJ-series Rack-mounting Unit: CS1W-SCU21(-V1),  
CJ1W-SCU21(-V1)/41(-V1)

**Reference:** CS-series Serial Communications Boards and Units with lot number 991220 (12/20/99) and later support the high-speed 1:N NT Link. Boards and Units with earlier lot numbers **cannot** be used.

**Setting the Front Switches**

Set the unit number of the Serial Communications Unit by using the rotary switch located on the front panel. Set each switch with a flat blade screwdriver so that the values or symbols in the setting value window agree with the following.

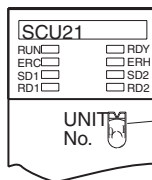

Set the unit number to 0 through F so that it will not overlap with the numbers used in other units.

**Allocation DM Area Settings for CPU Unit**

Setting is written from the Programming Device (a Programming Console or CX-Programmer) directly into the allocation DM area (system setting area) of the CPU Unit. After the setting is written, it becomes effective by turning the power ON, restarting the Unit, restarting the communications port, or execution of the STUP command.

In the following table, the channel numbers of the allocation DM area and settings are shown.

Word m = DM30000 + (100 × unit number)

| Allocated DM Area words |        | Setting | Setting Contents  |
|-------------------------|--------|---------|---|
| Port 1                  | Port 2 |         |   |
| m                       | m+10   | 8200    | 1:N NT Link Mode  |
| m+1                     | m+11   | 000A    | Baud rate (standard)                                      |
| m+6                     | m+16   | 000□    | □ = The highest unit number of the connected PTs (0 to 7) |

**When Using the Memory Link Method**

In the memory link method, the connection can be made to a personal computer with RS-232 and an FA computer, etc.

When connecting to the host in the memory link method, it is necessary to create a program for the memory link at the host side.

The following are the communications conditions that can be used in the memory link method. For the host (a personal computer, an FA computer, etc.), its setting should be compatible to one of the communications conditions listed in the following table. Set the same communications conditions at the NT631/NT631C by the memory switch. (page 160).

| Item                 | Settings at the host                      |
|----------------------|---|
| Input/Output port    | RS-232C                                   |
| Communications speed | 1200, 2400, 4800, 9600, 19200, 38400 bps. |
| Data bits length     | 7 bits, 8 bits                            |
| Stop bits length     | 1 bits, 2 bits                            |
| Parity               | None, even, odd                           |
| Flow control         | None, RS/CS, XON/XOFF                     |

**4-1-2 Connecting Directly between RS-232C Ports**

The method for connection between the RS-232C ports of the NT631/NT631C and the host is described here.

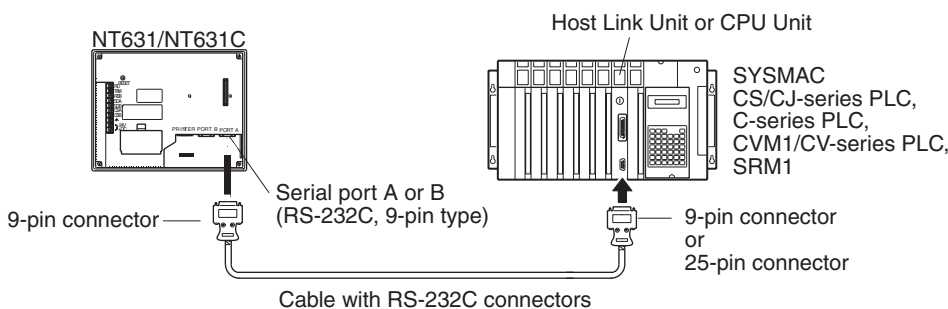

**Recommended Connector Cable**

When making the connector cable, as far as possible use the recommended connectors, connector hoods, and cables indicated in the table below. Some Units come supplied with one connector and one connector hood.

Check the required components and prepare them in advance.

| Name           | Model                   | Remarks   | Delivered with  |
|----------------|-------------------------|---|---|
| Connector      | XM2A-0901               | 9-pin<br>Made by OMRON                                      | CS-series CS1G/CS1H/<br>CS1D,<br>CJ-series CJ1G/CJ1H/<br>CJ1M,<br>C-series CQM1,<br>C200HS,<br>C200HX/HG/HE(-Z)E,<br>CVM1/CV-series CPU<br>Units<br>CV500-LK201 |
|                | XM24-2501               | 25-pin<br>Made by OMRON                                     | C500-LK203<br>CV500-LK201<br>C200H-LK201-EV1  |
|                | DB-25P                  | 25-pin<br>Made by JAE                                       | 3G2A5-LK201-EV1<br>3G2A6-LK201-EV1  |
| Connector hood | XM2S-0911               | 9-pin<br>Made by OMRON                                      | C-series CQM1,<br>C200HS,<br>C200HX/HG/HE(-Z)E,<br>CVM1/CV-series CPU<br>Units<br>CV500-LK201   |
|                | XM2S-0913               | 9-pin<br>Made by OMRON                                      |   |
|                | XM2S-0911-E             | 9-pin<br>Made by OMRON                                      | CS-series CS1G/CS1H/<br>CS1D,<br>CJ-series CJ1G/CJ1H/<br>CJ1M   |
|                | XM2S-2511               | 25-pin<br>Made by OMRON                                     | C500-LK203<br>CV500-LK201<br>C200H-LK201-EV1  |
|                | DB-C2-J9                | 25-pin<br>Made by JAE                                       | 3G2A5-LK201-EV1<br>3G2A6-LK201-EV1  |
| Cable          | AWG28×5P<br>IFVV-SB     | Multi-core shielded cable<br>Made by Fujikura, Ltd.         |   |
|                | CO-MA-VV-SB<br>5P×28AWG | Multi-core shielded cable<br>Made by Hitachi Cable,<br>Ltd. |   |

**Note** After connecting a communications cable, always secure it with the screws.

**OMRON Cables with Connectors**

When a connection is made at serial port A in other than the memory link method, OMRON cables with connectors shown below are available.

| Model     | Cable Length | Connector Specification |
|-----------|--------------|-------------------------|
| XW2Z-200S | 2 m          | 9-pin ↔ 25 pin          |
| XW2Z-500S | 5 m          |                         |
| XW2Z-200T | 2 m          | 9-pin ↔ 9-pin           |
| XW2Z-500T | 5 m          |                         |

When a connection is made to a personal computer at serial port A in the memory link method, OMRON cable with connectors shown below are available.

| Model       | Cable Length | Connector Specification |
|-------------|--------------|-------------------------|
| CV500-CN228 | 2 m          | 9-pin ↔ 25 pin          |
| XW2Z-S002   | 2 m          | 9-pin ↔ 9 pin           |

**Note** The cable's tensile load is 30 N. Do not subject it to loads greater than this.

**Wiring for a Host Link Unit (25-pin) Connection**

Applicable Units: C200H-LK201-EV1  
 3G2A5-LK201-EV1  
 C500-LK203  
 3G2A6-LK201-EV1  
 CV500-LK201 (communications port 1)

Cables with connectors that can be used at serial port A:  
 XW2Z-200S (9-pin ↔ 25-pin, 2 m)  
 XW2Z-500S (9-pin ↔ 25-pin, 5 m)

CVM1/CV-series Host Link Units (CV500-LK201) have two types of connector; a 25-pin connector (communications port 1), and a 9-pin connector (communications port 2). When using communications port 2, refer to *Wiring for Other Connections (Other Than the Memory Link Method)* (page 75).

**Serial Port A, B**

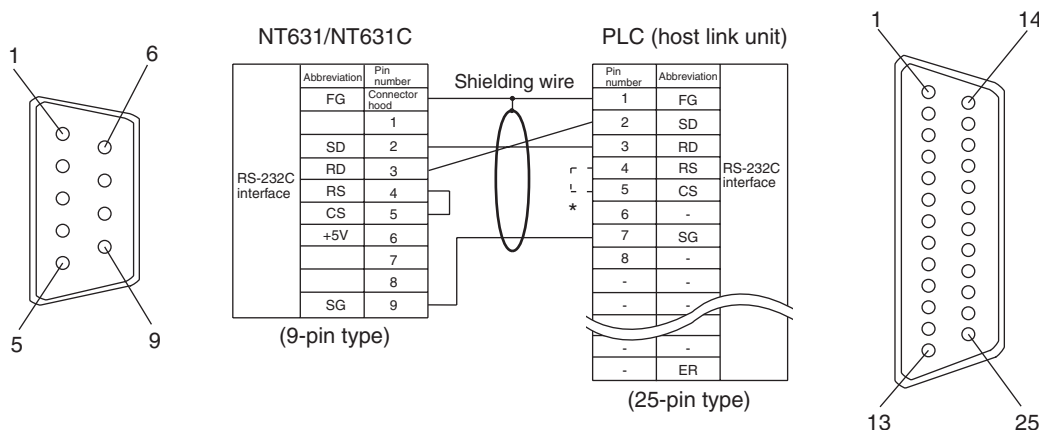

\* For Units that have a CTS setting selector switch, RS and CS do not have to be shorted if this switch is set to 0 V.

**Wiring for Other Connections**

Applicable Units:

|                                     |                  |
|-------------------------------------|------------------|
| CV500-LK201 (communications port 2) |                  |
| CS1W-SCU21(-V1)                     |                  |
| CJ1W-SCU21(-V1)                     | CJ1W-SCU41(-V1)  |
| CPM1-10CDR-□                        | CPM1-20CDR-□     |
| CPM1A-10CD□-□                       | CPM1A-20CD□-□    |
| CPM1A-30CD□-□                       | CPM1A-40CD□-□    |
| CPM2A-30CD□□-□                      | CPM2A-40CD□□-□   |
| CPM2A-60CD□□-□                      |                  |
| CPM2C-10□□□□□□-□                    | CPM2C-20□□□□□□-□ |
| CQM1-CPU21-E                        |                  |
| CQM1-CPU41-EV1                      | CQM1-CPU42-EV1   |
| CQM1-CPU43-EV1                      | CQM1-CPU44-EV1   |
| CQM1H-CPU11                         | CQM1H-CPU21      |
| CQM1H-CPU51                         | CQM1H-CPU61      |

- CS1G-CPU42/43/44/45-E(V1)
- CS1H-CPU63/64/65/66/67-E(V1)
- CS1G-CPU42H/43H/44H/45H
- CS1H-CPU63H/64H/65H/66H/67H
- CS1D-CPU65H/67H
- CJ1G-CPU44/45
- CJ1G-CPU42H/43H/44H/45H
- CJ1H-CPU65H/66H/67H
- CJ1M-CPU11/12/13/21/22/23
- C200HS-CPU21-E, -EC
- C200HS-CPU31-E
- C200HE-CPU32-(Z)E
- C200HG-CPU33-(Z)E
- C200HG-CPU53-(Z)E
- C200HX-CPU34-(Z)E
- C200HX-CPU54-(Z)E
- C200HX-CPU65-ZE
- CV500-CPU01-EV1
- CV2000-CPU01-EV1
- CVM1-CPU01-EV2
- CVM1-CPU21-EV2
- SRM1-C02-V2
- C200HS-CPU23-E
- C200HS-CPU33-E
- C200HE-CPU42-(Z)E
- C200HG-CPU43-(Z)E
- C200HG-CPU63-(Z)E
- C200HX-CPU44-(Z)E
- C200HX-CPU64-(Z)E
- C200HX-CPU85-ZE
- CV1000-CPU01-EV1
- CVM1-CPU11-EV2

Cables with connectors that can be used at serial port A:

- XW2Z-200T (9-pin ⇔ 9-pin, 2 m)
- XW2Z-500T (9-pin ⇔ 9-pin, 5 m)

CPU Units of CVM1/CV-series PLCs without the suffix -EV□ cannot be connected by any connection method.

When connecting to the peripheral port of a CS/CJ-series CPU Unit, a CS1W-CN118 Connecting Cable is required in addition to the above cables.

**Serial Port A, B**

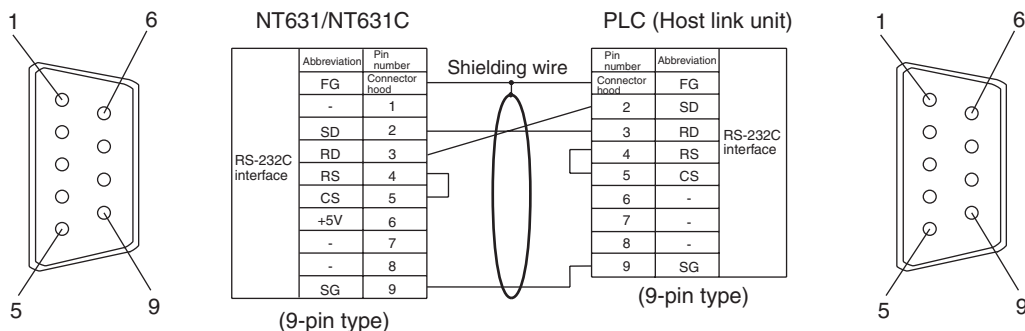

**Wiring for a Memory Link Connection**

Cables with connectors that can be used:

- CV500-CN228 (9-pin⇔25-pin, 2 m)
- XW2Z-S002 (9-pin⇔9-pin, 2 m)

**Serial Port A, B**

Prepare the adapter cable while referring to the following diagram.

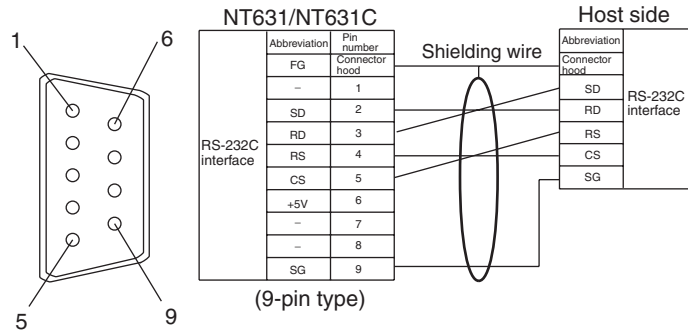





# SECTION 5

## Connecting to the Host from the RS-422A/485 Port

This section describes the method for connecting to the host using the RS-422A/485 port of the PT.

|       |   |     |
|-------|---|-----|
| 5-1   | Connecting to the Host's RS-232C Port . . . . .                                   | 80  |
| 5-1-1 | The Type of Host and Settings . . . . .   | 81  |
| 5-1-2 | 1:1 Connection between RS-422A/485 at the PT and RS-232C<br>at the Host . . . . . | 82  |
| 5-1-3 | 1:N Connection between RS-422A/485 at the PT and RS-232C<br>at the Host . . . . . | 86  |
| 5-1-4 | Recommended Connectors, Cables, and Crimp Terminals . . . . .                     | 90  |
| 5-1-5 | Setting the Terminal Resistance for RS-422A/485 Communications                    | 92  |
| 5-2   | Connecting to the Host's RS-422A/485 Port . . . . .                               | 93  |
| 5-2-1 | Host Types and Settings . . . . .   | 94  |
| 5-2-2 | Direct Connection between RS-422A Ports at Both Units . . . . .                   | 115 |
| 5-2-3 | Direct Connection between RS-485 Ports at Both Units . . . . .                    | 118 |
| 5-2-4 | 1:N Connection among RS-422A Ports . . . . .                                      | 119 |
| 5-2-5 | 1:N Connection among RS-485 Ports . . . . .                                       | 121 |
| 5-2-6 | Recommended Connectors, Cables and Crimp Terminals . . . . .                      | 123 |
| 5-2-7 | Setting the Terminal Resistance for RS-422A/485 Communications                    | 124 |
| 5-2-8 | Handling the Shield on RS-422A/485 Cables . . . . .                               | 125 |

## 5-1 Connecting to the Host's RS-232C Port

The methods for connecting the RS-422A/485 port of the NT631/NT631C and the RS-232C port of the host are described here. There are the following methods.

The following discussion is focused on the connection method to OMRON PLCs (By using the memory link method, a connection can be made to any arbitrary RS-232 unit). When making a connection to a host other than OMRON PLCs, refer to the *PLC Connection Manual (V042-E1-□)* or *NT31/631 Multi Vendor Connection Manual (V060-E1-□)*.

- Method in which the RS-422A port of the NT631/NT631C and the RS-232C port of the host are connected in a 1:1 connection via an RS-232C/RS-422A Adapter (page 82).

When this method is used, the cable length can be extended up to 500 m.

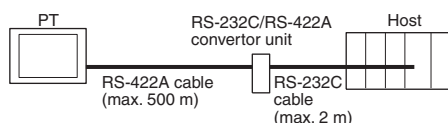

- Method in which the RS-485 port of the NT631/NT631C and the RS-232C port of the host are connected in a 1:1 connection via an RS-232C/RS-422A Adapter (page 82).

When this method is used, the cable length can be extended up to 500 m. This connection method can be used only with the NT Link (1:N) method of type RS-485.

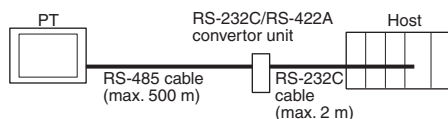

- Method in which the RS-422A ports of multiple NT631/NT631Cs and the RS-232C port of the host are connected in a 1:N connection via an RS-232C/RS-422A Adapter (page 86).

This connection method is used with the RS-422A NT Link (1:N) method.

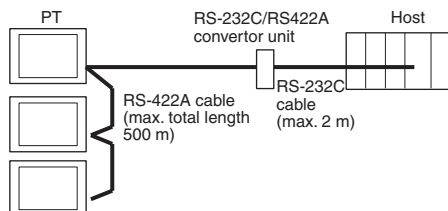

- Method in which the RS-485 ports of multiple NT631/NT631Cs and the RS-232C port of the host are connected in a 1:N connection via an RS-232C/RS-422A Adapter (page 86).

This connection method is used with the RS-485 NT Link (1:N) method (standard or high-speed).

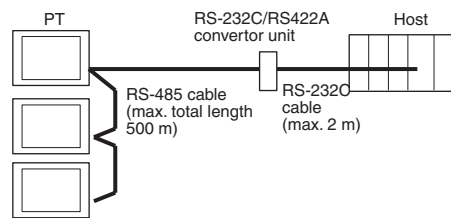

**Note** One end of the wire must always be connected to the host (PLC), and there must be no branching. Branching will cause problems such as transmission delays and communications failures.

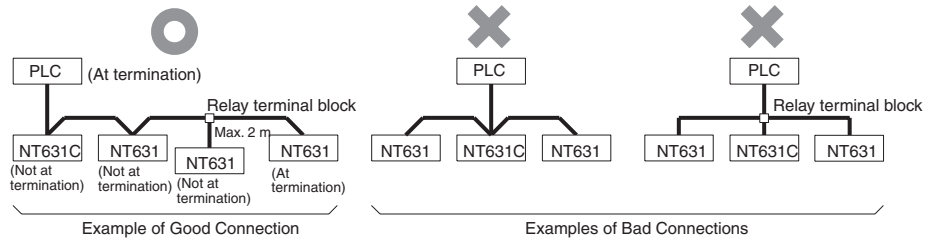

**Reference:** CS/CJ-series CPU Units cannot be connected with the 1:1 connection NT Link method. Use the 1:N connection NT Link method (standard or high-speed) instead to make the 1:1 connection. For details, refer to *Using the NT Link (1:N) Method* (page 65) or *Using the High-speed NT Link (1:N) Method* (page 70).

### 5-1-1 The Type of Host and Settings

The using condition is the same as the connecting PT side RS-232C and the host side RS-232C.

For the available type and settings of the host, refer to the pages listed below.

| Method                   | Reference   |
|--------------------------|---|
| Host link                | Host Link Method (page 48)                          |
| NT Link (1:1)            | NT Link (1:1) method (page 61)                      |
| NT Link (1:N)            | Using the NT Link (1:N) Method (page 65)            |
| High-speed NT Link (1:N) | Using the High-speed NT Link (1:N) Method (page 70) |
| Memory link              | Memory Link Method (page 73)                        |

#### Settings at the RS-232C/RS-422A Adapter (NT-AL001)

When making a connection between RS-232C and RS-422A/485 ports using an RS-232C/RS-422A Adapter, set the DIP switches on the NT-AL001 as follows.

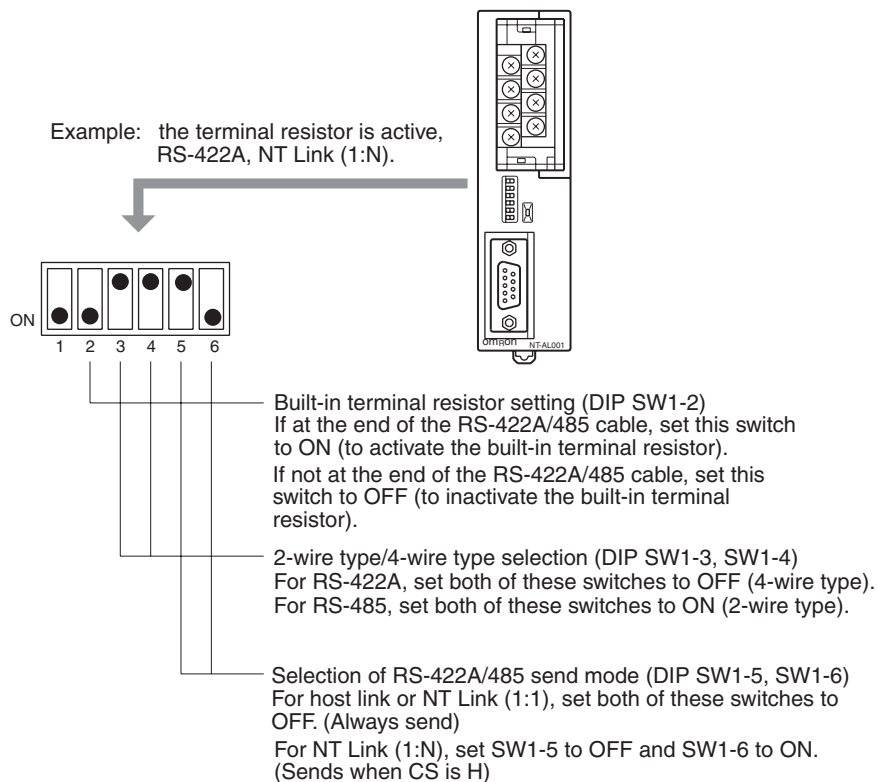

**Note** Read the manual supplied with the NT-AL001 carefully before using the Unit.

### 5-1-2 1:1 Connection between RS-422A/485 at the PT and RS-232C at the Host

The connection method in which the RS-422A/485 port of an NT631/NT631C and the RS-232C port of a host are connected via a Adapter is described here.

An RS-232C/RS-422A Adapter (NT-AL001) is used to convert between the RS-232C and RS-422A communications methods.

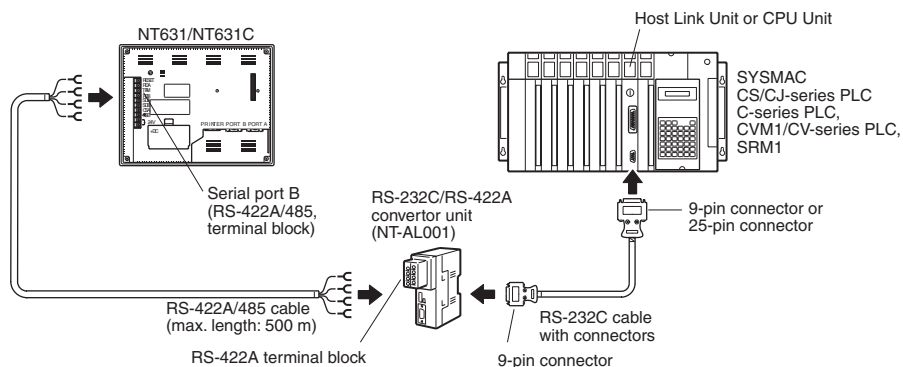

**Reference:** When using RS-485 as a port for the NT631/NT631C, only NT Link (1:N) method (standard or high-speed) can be used.

**Connecting an NT631/NT631C and NT-AL001 (RS-422A)**

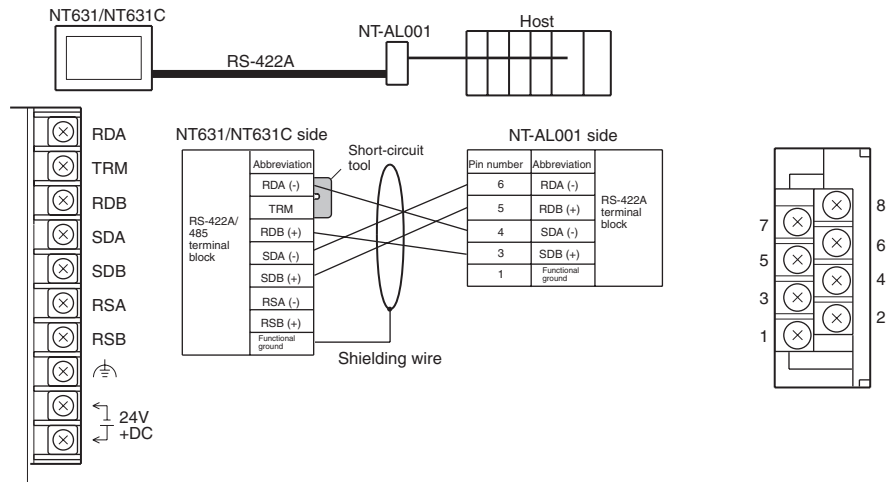

For details on handling shield wires, refer to 5-2-8 Handling the Shield on RS-422A/485 Cables on page 125.

**Connecting an NT631/NT631C and NT-AL001 (RS-485)**

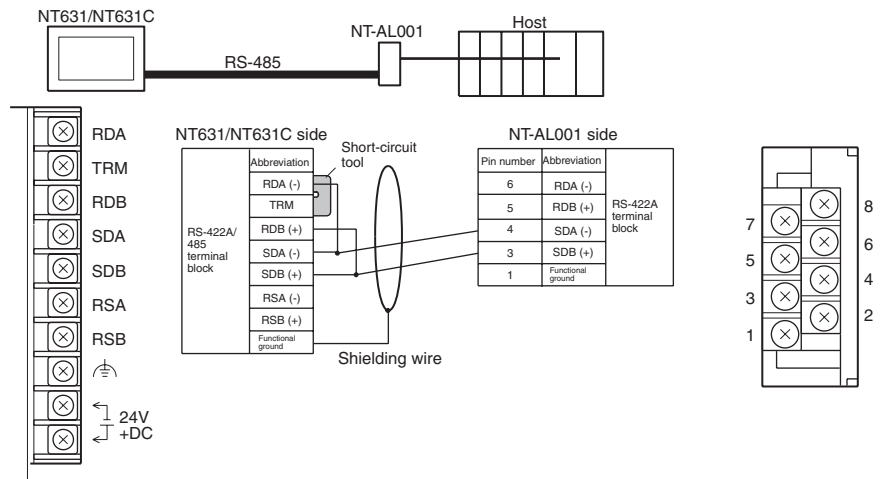

For details on handling shield wires, refer to 5-2-8 Handling the Shield on RS-422A/485 Cables on page 125.

**Reference:** When using RS-485 as a port for the NT631/NT631C, only NT Link (1:N) method (standard or high-speed) can be used.

**Connecting an NT-AL001 and Host**

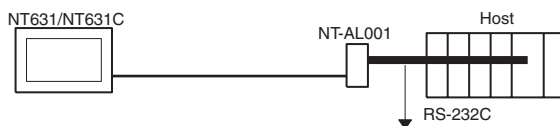

**Wiring When Connecting a Host Link Unit (25-pin)**

Applicable Units:

- C200H-LK201-V1
- 3G2A5-LK201-EV1
- C500-LK203
- 3G2A6-LK201-EV1
- CV500-LK201 (communications port 1)

CVM1/CV-series Host Link Unit (CV500-LK201) has two types of connector: a 25-pin connector (communications port 1), and a 9-pin connector (communications port 2). When using the communications port, refer to Wiring for Connections other than Memory Link (page 84).

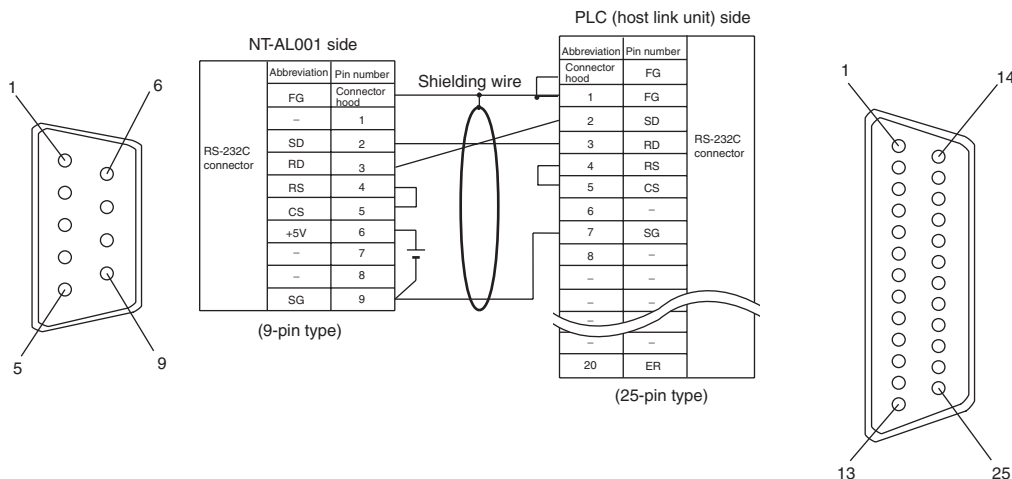

**Wiring for Connections Other Than Memory Link**

Applicable Units:

- CV500-LK201 (communications port 2)
- CS1W-SCU21(-V1)
- CJ1W-SCU21(-V1)
- CPM1-10CDR-□
- CPM1A-10CD□-□
- CPM1A-30CD□-□
- CPM2A-30CD□□-□
- CPM2A-60CD□□-□
- CPM2C-10□□□□□□-□
- CQM1-CPU21-E
- CQM1-CPU41/42/43/44-EV1
- CQM1H-CPU11/21/51/61
- CS1G-CPU42/43/44/45-E(V1)
- CS1H-CPU63/64/65/66/67-E(V1)
- CS1G-CPU42H/43H/44H/45H
- CS1H-CPU63H/64H/65H/66H/67H
- CS1D-CPU65H/67H
- CJ1G-CPU44/45
- CJ1G-CPU42H/43H/44H/45H
- CJ1H-CPU65H/66H/67H
- CJ1M-CPU11/12/13/21/22/23
- C200HS-CPU21/23/31/33
- CJ1W-SCU41(-V1)
- CPM1-20CDR-□
- CPM1A-20CD□-□
- CPM1A-40CD□-□
- CPM2A-40CD□□-□
- CPM2C-20□□□□□□-□

- C200HE-CPU32/42(-Z)E
- C200HG-CPU33/43/53/63(-Z)E
- C200HZ-CPU34/44/54/64(-Z)E
- C200HX-CPU65-ZE
- CV500-CPU01-EV1
- CV2000-CPU01-EV1
- CVM1-CPU01-EV2
- CVM1-CPU21-EV2
- SRM1-C02-V2
- C200HX-CPU85-ZE
- CV1000-CPU01-EV1
- CVM1-CPU11-EV2

Usable Cables with Attached Connectors:

- For host link, 1:1 NT Link, or 1:N NT Link (+5 V power supplied from PLC)
  - XW2Z-070T-1(9-pin to 9-pin, 0.7 m)
  - XW2Z-200T-1(9-pin to 9-pin, 2 m)

CVM1/CV-series CPU Units whose model names do not have the suffix -EV□ cannot be connected by any connection method.

When connecting to the peripheral port of a CS/CJ-series CPU Unit, a CS1W-CN118 Connecting Cable is required in addition to the above cables. (Supply power to the +5-V output of the NT-AL001 from an external power supply when using this method.)

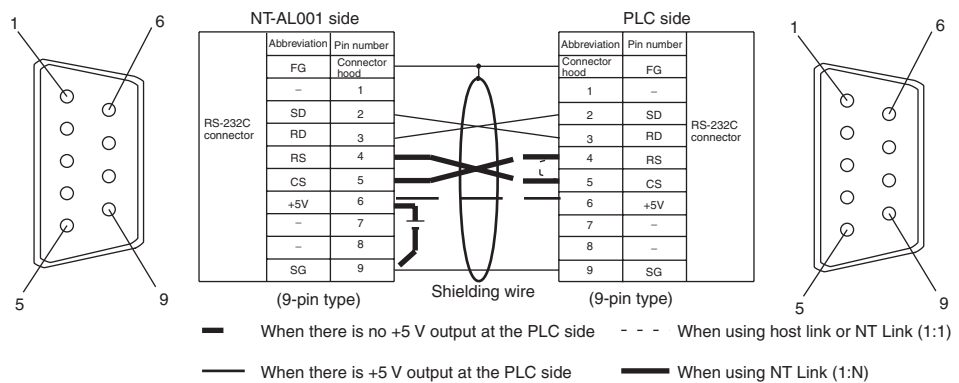

- When using the host link or NT Link (1:1) method, short the RS and CS terminals at the PLC side with each other (leave the RS and CS terminals at the NT-AL001 side open).
- When using the NT Link (1:N), cross-connect the RS and CS terminals at the NT-AL001 and PLC sides.

If there is +5 V output at the PLC side, no external power supply is required for the NT-AL001.

**Wiring for a Memory Link Connection**

Prepare the adapter cable while referring to the diagram shown below.

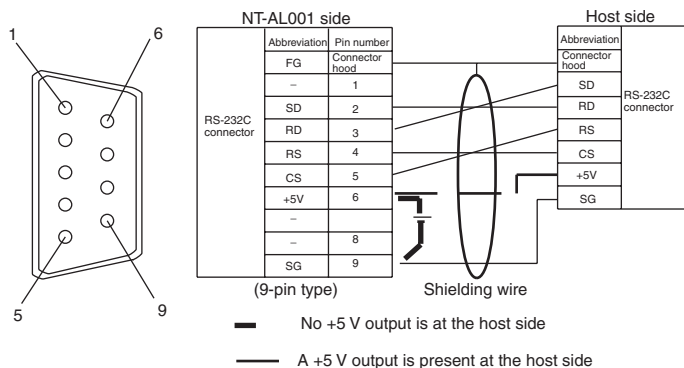

Since it is necessary to input a voltage of +5 V to the number 6 pin of NT-AL001, supplying a voltage of 5 V from the host or an external voltage supply for NT-AL001 is required.

**5-1-3 1:N Connection between RS-422A/485 at the PT and RS-232C at the Host**

The connection method in which the RS-422A/485 ports of multiple NT631/NT631Cs are connected to the RS-232C port of one host in a 1:N connection is described here.

An RS-232C/RS-422A Adapter (NT-AL001) is used to convert between the RS-232C and RS-422A/485 communications methods.

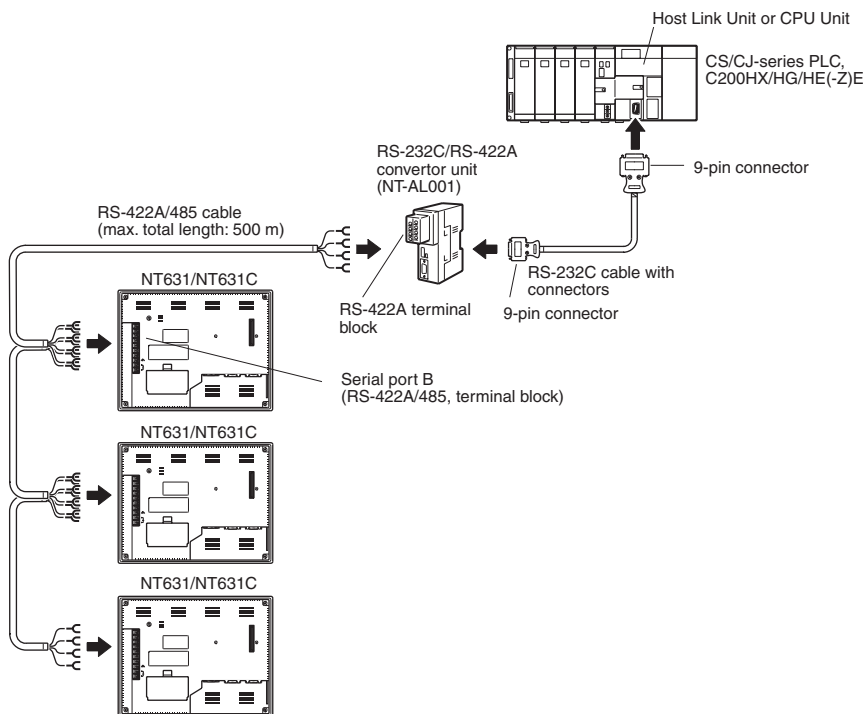



**Connecting an NT631/  
NT631C and NT-AL001  
(RS-422A)**

The relay terminal board is not included in the figure below. Insert a relay terminal board so as to achieve the wiring configuration indicated below.

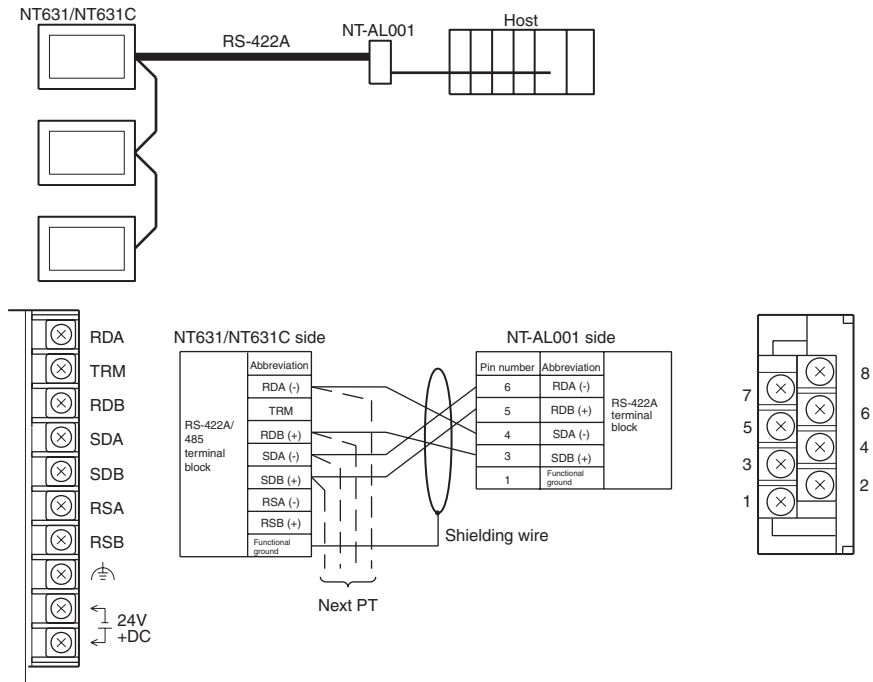

For details on handling shield wires, refer to 5-2-8 Handling the Shield on RS-422A/485 Cables on page 125.

**Connecting an NT631/  
NT631C and NT-AL001(RS-485)**

The relay terminal board is not included in the figure below. Insert a relay terminal board so as to achieve the wiring configuration indicated below.

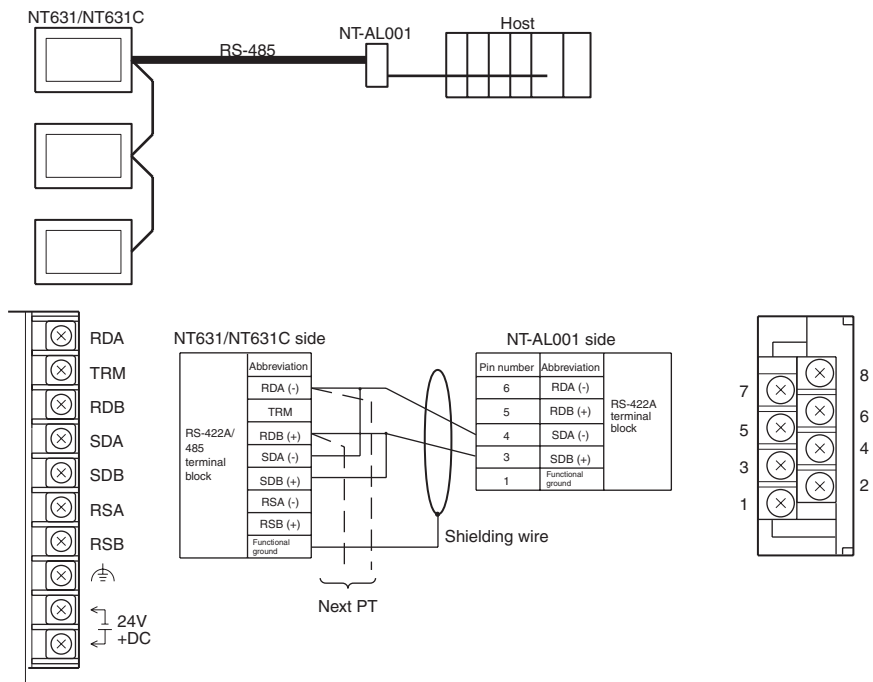

For details on handling shield wires, refer to 5-2-8 Handling the Shield on RS-422A/485 Cables on page 125.

**Connection between NT631/NT631C Units (RS-422A)**

The relay terminal board is not included in the figure below. Insert a relay terminal board so as to achieve the wiring configuration indicated below.

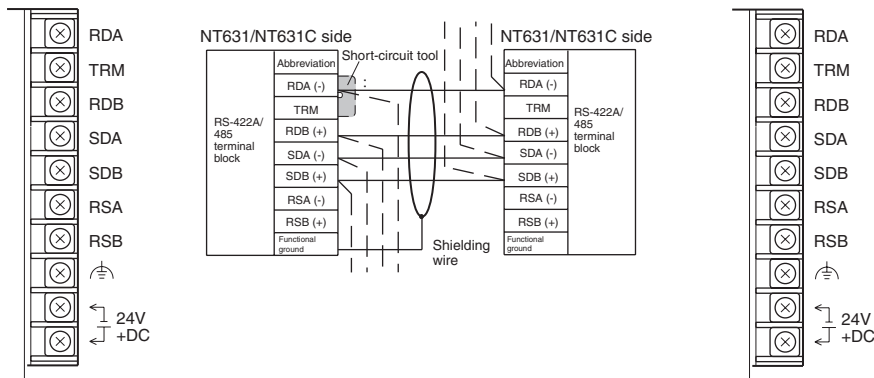
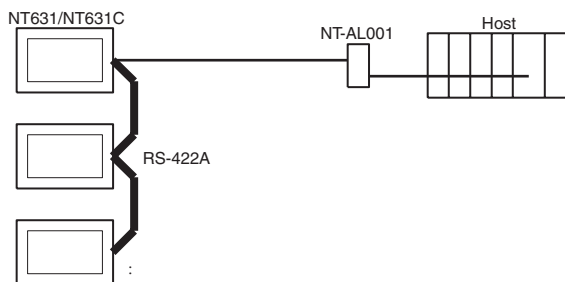

\* Short TRM and RDA terminals of the NT631/NT631C at the end of the RS-422A cable (\* marked in the above figure) using the short-circuit tool supplied with the NT631/NT631C.

For details on handling shield wires, refer to 5-2-8 Handling the Shield on RS-422A/485 Cables on page 125.

**Connection between NT631/NT631C Units (RS-485)**

The relay terminal board is not included in the figure below. Insert a relay terminal board so as to achieve the wiring configuration indicated below.

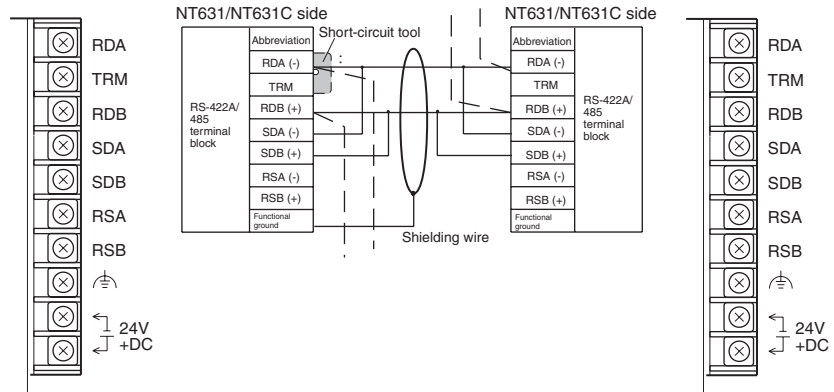
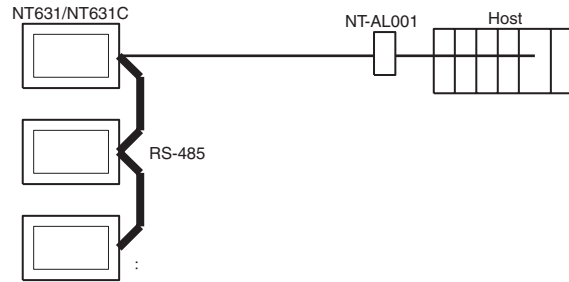

\* Short TRM and RDA terminals of the NT631/NT631C at the end of the RS-485 cable (\* marked in the above figure) using the short-circuit tool supplied with the NT631/NT631C.

For details on handling shield wires, refer to 5-2-8 Handling the Shield on RS-422A/485 Cables on page 125.

**Connecting an NT-AL001 and Host**

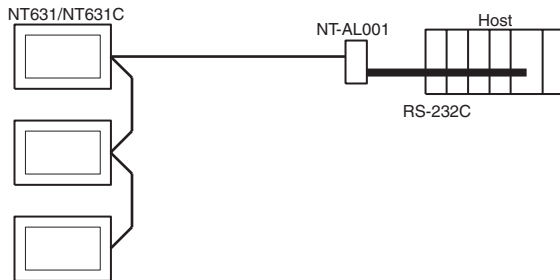

**Wiring when connecting a CS-series Serial Communications Board, CS/CJ-series Serial Communications Unit, CQM1H Serial Communications Board, or C-series C200HX/HG/HE(-Z)E Communications Board**

Applicable Units:

- CS1W-SCU21(-V1)
- CJ1W-SCU21(-V1)/CJ1W-SCU41(-V1)
- CS1G-CPU42/43/44/45-E(V1)
- CS1H-CPU63/64/65/66/67-E(V1)
- CS1G-CPU42H/43H/44H/45H
- CS1H-CPU63H/64H/65H/66H/67H
- CS1D-CPU65H/67H (See note.)

- CJ1G-CPU44/45
- CJ1G-CPU42H/43H/44H/45H
- CJ1H-CPU65H/66H/67H
- CJ1M-CPU11/12/13/21/22/23
- CQM1H-CPU51/61
- C200HE-CPU32/42(-Z)E
- C200HG-CPU33/43/53/63(-Z)E
- C200HX-CPU34/44/54/64(-Z)E
- C200HX-CPU65-ZE/85-ZE

**Note** A Serial Communications Board cannot be installed.

Usable Cables with Attached Connectors:

For host link, 1:1 NT Link, or 1:N NT Link (+5 V power supplied from PLC)

XW2Z-070T-1(9-pin to 9-pin, 0.7 m)

XW2Z-200T-1(9-pin to 9-pin, 2 m)

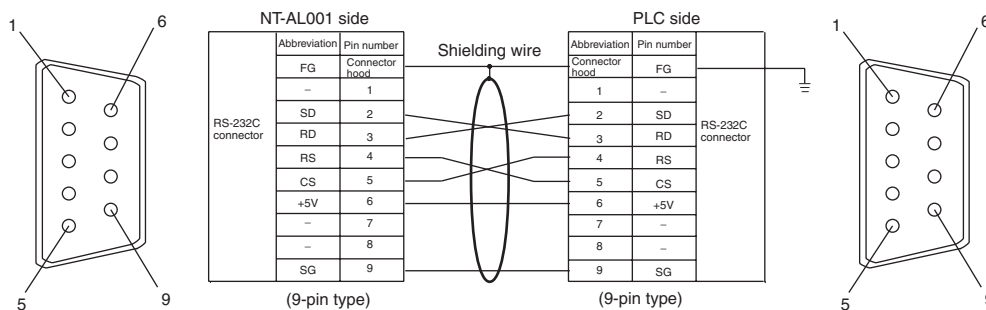

Since the CS1G/H, CQM1H, and C200HX/HG/HE(-Z)E have a +5 V output, no external power supply is required for the NT-AL001.

### 5-1-4 Recommended Connectors, Cables, and Crimp Terminals

#### Connectors and Cables Recommended for RS-232C

When making an RS-232C connecting cable, as far as possible use the recommended parts indicated in the table below. Some Units come supplied with one connector and connector hood.

Check the required parts and prepare them in advance.

| Name      | Model     | Remarks                      | Delivered with   |
|-----------|-----------|------------------------------|--|
| Connector | XM2A-0901 | 9-pin type<br>Made by OMRON  | CS/CJ-series PLCs,<br>C-series CQM1, C200HS,<br>C200HX/HG/HE(-Z)E<br>CVM1/CV-series CPU Units<br>CV500-LK201 |
|           | XM2A-2501 | 25-pin type<br>Made by OMRON | C500-LK203<br>3G2A5-LK201-EV1<br>C200H-LK201-V1  |
|           | DB-25P    | 25-pin type<br>Made by JAE   | 3G2A5-LK201-EV1<br>3G2A6-LK201-EV1   |

| Name           | Model                   | Remarks  | Delivered with   |
|----------------|-------------------------|--|--|
| Connector hood | XM2S-0911               | 9-pin type<br>Made by OMRON                            | C-series CQM1, C200HS,<br>C200HX/HG/HE(-Z)E<br>CVM1/CV-series CPU Units<br>CV500-LK201 |
|                | XM2S-0913               | Made by OMRON 9-pin                                    |  |
|                | XM2S-0911-E             | Made by OMRON 9-pin                                    | CS/CJ-series CPU Units   |
|                | XM2S-2511               | 25-pin type<br>Made by OMRON                           | C500-LK203<br>3G2A5-LK201-EV1<br>C200H-LK201-V1  |
|                | DB-C2-J9                | 25-pin type<br>Made by JAE                             | 3G2A5-LK201-EV1<br>3G2A6-LK201-EV1   |
| Cable          | AWG28×5P<br>IFVV-SB     | Multi-core shielded<br>cable<br>Made by Fujikura, Ltd. |  |
|                | CO-MA-VV-SB<br>5P×28AWG | Multi-core shielded<br>cable<br>Made by Hitachi, Ltd.  |  |

#### **Cables with Connectors Made by OMRON**

When connecting an NT-AL001 and a PLC, use the OMRON cables with connectors indicated in the table below.

| Model       | Cable Length | Connector Specification  |
|-------------|--------------|--|
| XW2Z-070T-1 | 0.7 m        | 9-pin ↔ 9-pin  |
| XW2Z-200T-1 | 2 m          | Host link, NT Link (1:1), NT Link (1:N)<br>+5 V power supplied from PLC<br>(Use when the PLC has a +5 V output.) |

- Note**
1. The maximum tensile load of the recommended cable is 30 N. Do not exceed this load.
  2. After connecting a connecting cable, always tighten the connector screws.

#### **Recommended Connectors, Cables and Crimp Terminals for RS-422A/485**

When making an RS-422A/485 connecting cable, as far as possible use the recommended parts indicated in the table below. Some Units come supplied with one connector and connector hood.

Check the required parts and prepare them in advance.

| Name           | Model      | Maker                        | Remarks  |
|----------------|------------|------------------------------|--|
| Connector      | XM2A-2501  | 25-pin type<br>Made by OMRON | Delivered with the following<br>Units:<br>C500-LK203                         |
|                | DB-25P F-N | 25-pin type<br>Made by JAE   | Delivered with the following<br>Units:<br>3G2A6-LK201-EV1<br>3G2A5-LK201-EV1 |
| Connector hood | XM2S-2511  | 25-pin type<br>Made by OMRON | Delivered with the following<br>Units:<br>C500-LK203                         |
|                | DB-C2-J9   | 25-pin type<br>Made by JAE   | Delivered with the following<br>Units:<br>3G2A6-LK201-EV1<br>3G2A5-LK201-EV1 |

| Name            | Model                  | Maker                          | Remarks  |
|-----------------|------------------------|--------------------------------|--|
| Cable           | TKVBS4P-03             | Tachii Electric Wire Co., Ltd. |  |
| Crimp terminals | 1.25-N3A (fork type)   | Japan Solderless Terminal MFG  | Recommended cable size: AWG22 to 18 (0.3 to 0.75 mm <sup>2</sup> ) |
|                 | Y1.25-3.5L (fork type) | Molex Inc.                     |  |

The terminal screws of the NT631/NT631C are M3.5 specification. When wiring, use crimp terminals for M3.5 use. Tighten terminal screws with a tightening torque of 0.8 N·m.

**Note** Always use crimp terminals for wiring.

Examples of applicable terminals



### 5-1-5 Setting the Terminal Resistance for RS-422A/485 Communications

The serial port B connector of the NT631/NT631C has a terminal resistance setting terminal (TRM).

In RS-422A/485 communications, a terminal resistor must be set at the device at the end of the communications cable, but not at any other device.

The NT631/NT631C has a built-in terminal resistor, and whether or not the terminal resistance is applied is set by shorting or opening the terminal resistance setting terminals (TRM). The terminal resistance is 120 Ω.

When carrying out RS-422A/485 communications using serial port B, short between TRM and RDA terminals at the NT631/NT631C at the end of the RS-422A/485 cable. Leave these terminals open at NT631/NT631C PTs other than the one at the end of the cable.

When not using RS-422A/485 communications, the terminal resistance setting is ineffective.

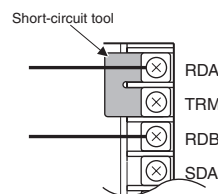

| TRM-RDA terminals | Function   |
|-------------------|--|
| Shorted           | Terminal resistance is applied.<br>Short only at the NT631/NT631C connected to the end of an RS-422A/485 cable.  |
| Open              | Terminal resistance is not applied.<br>Leave the terminals open when connecting an NT631/NT631C anywhere other than at the end of the RS-422A/485 cable. |

**Note** Before connecting or disconnecting cables between devices, make sure that the power supply to all of the connected devices (NT631/NT631C, PLC, etc.) is OFF.

- Reference:**
- The internal circuit of the NT631/NT631C is shown below.

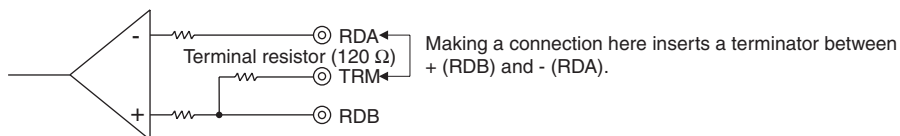

- For details on setting the terminal resistance of NT-AL001, refer to *Settings at the RS-232C/RS-422A Adapter (NT-AL001)* (page 81).

## 5-2 Connecting to the Host's RS-422A/485 Port

The methods for connecting the RS-422A/485 port of the NT631/NT631C and the RS-422A/485 port of the host are described here. There are the following methods.

The following discussion is focused on the connection method to OMRON PLCs (By using the memory link method, a connection can be made to any arbitrary RS-422 unit). When making a connection to a host other than OMRON PLCs, refer to the *PLC Connection Manual (V042-E1-□)* or *Multi Vendor Connection Manual (V060-E1-□)*.

- Method in which the RS-422A ports of the NT631/NT631C and host are connected directly by an RS-422A cable (page 115).

When this method is used, the cable length can be extended up to 500 m.

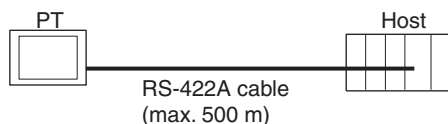

- Method in which the RS-485 ports of the NT631/NT631C and host are connected by an RS-485 cable (page 118).

When this method is used, the cable length can be extended up to 500 m.

This connection method can be used only with the NT Link (1:N) method (standard or high-speed) of type RS-485.

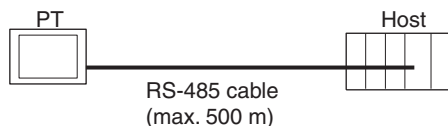

- Method in which the RS-422A ports of multiple NT631/NT631Cs and the RS-422A port of the host are connected in a 1:N connection (page 119).

This connection method is used with the RS-422A NT Link (1:N) method (standard or high-speed).

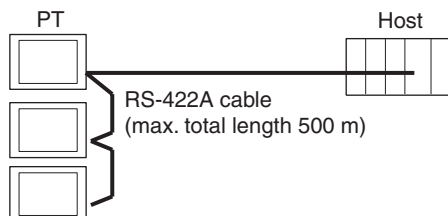

- Method in which the RS-485 ports of multiple NT631/NT631Cs and the RS-485 port of the host are connected in a 1:N connection (page 121).

This connection method is used with the RS-485 NT Link (1:N) method (standard or high-speed).

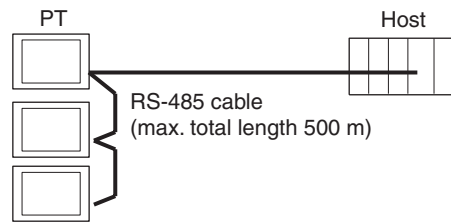

**Note** One end of the wire must always be connected to the host (PLC), and there must be no branching. Branching will cause problems such as transmission delays and communications failures.

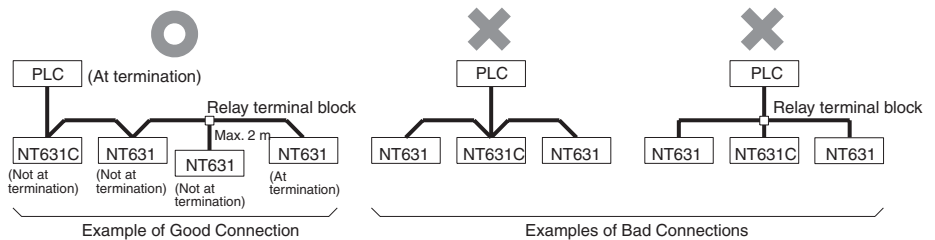

**Reference:** CS/CJ-series CPU Units cannot be connected with the 1:1 connection NT Link method. Use the 1:N connection NT Link method (standard or high-speed) instead to make the 1:1 connection. For details, refer to *Using the NT Link (1:N) Method* (page 106) or *Using the High-speed NT Link (1:N) Method* (page 108).

### 5-2-1 Host Types and Settings

The types of host that have an RS-422A port and can be connected to the RS-422A/485 port of the NT631/NT631C, and the settings to be made at the host, are described here.

#### When Using the Host Link Method

#### Compatible Host Units

Some models and series of OMRON PLCs have the RS-422A/485 host link function built in. With the CS/CJ-series and CQM1H, the host link method can be used by installing a Serial Communications Board/Unit. In addition, some C200HX/HG/HE(-Z)E CPU Unit can be connected in the host link method by installing a Communications Board.

With the CPM2A and CPM2C, an RS-422A of 1:1 NT Link can be created through a CPM1-CIF11 RS-422A Adapter.

Check the model and series of the PLC and the type of the installed Board or Unit before making a connection.



The hosts featuring the RS-422A/485 host link function and can be connected to the RS-422A/485 port of the NT631/NT631C are indicated in the table below.

| PLC Series | CPU Unit with built-in Host Link                                    | CPU Units Connectable with Host Link Units or Expansion Communications Board/Units   | Host Link Unit or Communications Board/ Unit | Connectable to  |
|------------|---|--|--|---|
| CS Series  |   | CS1G-CPU42/43/44/45-E(V1)<br>CS1H-CPU63/64/65/66/67-E(V1)<br>CS1G-CPU42H/43H/44H/45H<br>CS1H-CPU63H/64H/65H/66H/67H<br>CS1D-CPU65H/67H <sup>(*)</sup>  | CS1W-SCB41(-V1)<br>CS1W-SCU31(-V1)           | CS1G<br>CS1H<br>CS1D  |
| CJ Series  |   | CJ1G-CPU44/45<br>CJ1G-CPU42H/43H/44H/45H<br>CJ1H-CPU65H/66H/67H<br>CJ1M-CPU11/12/13/21/22/23   | CJ1W-SCU31(-V1)<br>CJ1W-SCU41(-V1)           | CJ1G<br>CJ1H<br>CJ1M  |
| C Series   |   | C1000H-CPU01-EV1<br>C2000H-CPU01-EV1   | 3G2A6-LK202-EV1                              | C1000H<br>C2000H  |
|            |   | C200HS-CPU01/03/21/23/31/33-E<br>C200HS-CPU01/21-EC<br>C200HE-CPU11/32/42-E<br>C200HE-CPU11/32/42-ZE<br>C200HG-CPU33/43/53/63-E<br>C200HG-CPU33/43/53/63-ZE<br>C200HX-CPU34/44/54/64-E<br>C200HX-CPU34/44/54/64/65/85-ZE | C200H-LK202-V1                               | C200HS<br>C200HE<br>C200HE-ZE<br>C200HG<br>C200HG-ZE<br>C200HX<br>C200HX-ZE |
|            |   | C200HE-CPU32/42-E<br>C200HE-CPU32/42-ZE<br>C200HG-CPU33/43/53/63-E<br>C200HG-CPU33/43/53/63-ZE<br>C200HX-CPU34/44/54/64-E<br>C200HX-CPU34/44/54/64/65/85-ZE  | C200HW-COM03/06-EV1                          | C200HE<br>C200HE-ZE<br>C200HG<br>C200HG-ZE<br>C200HX<br>C200HX-ZE           |
|            |   | C1000H-CPU01-EV1<br>C2000H-CPU01-EV1   | 3G2A5-LK201-EV1                              | C1000H<br>C2000H  |
|            |   | C1000H-CPU01-EV1<br>C2000H-CPU01-EV1   | C500-LK203                                   | C1000H<br>C2000H  |
|            | CPM1-10/20/30CDR-□<br>+CPM1-CIF11                                   |  |  | CPM1  |
|            | CPM1A-10/20/30/40CD□-□<br>+CPM1-CIF11                               |  |  |   |
|            | CPM2A-30/40/60CD□□-□<br>+CPM1-CIF11<br>(Peripheral port connection) |  |  | CPM2A   |
|            | CPM2C-10/20□□□□□□-□ <sup>(*)</sup>                                  |  |  | CPM2C   |
|            |   | CQM1H-CPU51/61   | CQM1H-SCB41                                  | CQM1H   |

| PLC Series       | CPU Unit with built-in Host Link | CPU Units Connectable with Host Link Units or Expansion Communications Board/Units | Host Link Unit or Communications Board/Unit | Connectable to |
|------------------|----------------------------------|--|---|----------------|
| CV Series (*3)   | CV500-CPU01-EV1                  | CV500-CPU01-EV1  | CV500-LK201                                 | CV500          |
|                  | CV1000-CPU01-EV1                 | CV1000-CPU01-EV1   |   | CV1000         |
|                  | CV2000-CPU01-EV1                 | CV2000-CPU01-EV1   |   | CV2000         |
| CVM1 Series (*3) | CVM1-CPU01-EV2                   | CVM1-CPU01-EV2   | CV500-LK201                                 | CVM1           |
|                  | CVM1-CPU11-EV2                   | CVM1-CPU11-EV2   |   |                |
|                  | CVM1-CPU21-EV2                   | CVM1-CPU21-EV2   |   |                |
| SRM1             | SRM1-C02-V1+CPM1-CIF11           |  |   | SRM1           |

\*1 This CPU Unit is for a Duplex-CPU Unit System. The CS1W-SCB41(-V1) Serial Communications Board cannot be used.

\*2 Use a CPM2C-CN111 or CS1W-CN114/118 Connecting Cable, CPM1-CIF01 RS-232C Adapter, or CPM1-CIF11 RS-422A Adapter to connect.

\*3 CPU Units of CVM1/CV-series PLCs without the suffix -EV□ cannot be connected.

The host link method cannot be used when an NT631/NT631C is connected using RS-485. To use the host link method, connect by RS-422A.

**Settings at the Host**

When using the RS-422A host link method, the settings shown below must be made at the host (depending on the Unit, some of these settings may not be necessary, or settings not shown here may be necessary).

| Item                 | Setting at Host                                  |
|----------------------|--|
| I/O port             | RS-422A  |
| Communications speed | Set the same speed as for the NT631/NT631C. (*1) |
| Transfer code        | ASCII, 7 data bits, 2 stop bits                  |
| Parity               | Even   |
| 1-to-1/1-to-N        | 1-to-N(*2)                                       |
| Instruction level    | Level 1, 2, 3                                    |
| Unit #               | 00   |

\*1 Set the host link communications speed at 9600 bps or 19200 bps with the Comm. Speed memory switch at the NT631/NT631C. For details, refer to 6-7-2 *Setting the Host Link Method* (page 155).

\*2 The 1-to-N setting enables BCC (Block Check Character). It is not actually possible to connect more than one NT631/NT631C in a single host link.

The setting methods for each type of Unit are described in the following.

Connecting to a C-series Host Link Unit

**C200H/C200HS/C200HE(-Z)E/C200HG(-Z)E/C200HX(-Z)E**  
**Rack-mounting Unit: C200H-LK201-V1**

**Setting the Front Switches**

Set each switch with a flat blade screwdriver so that the values or symbols in the setting value window agree with the following:

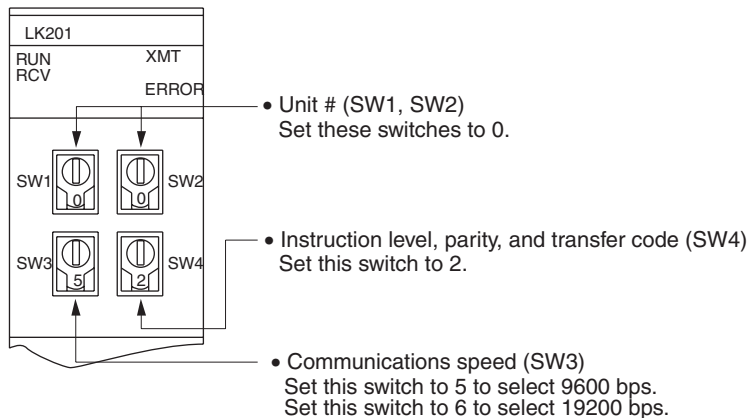

**Setting the Rear Switches**

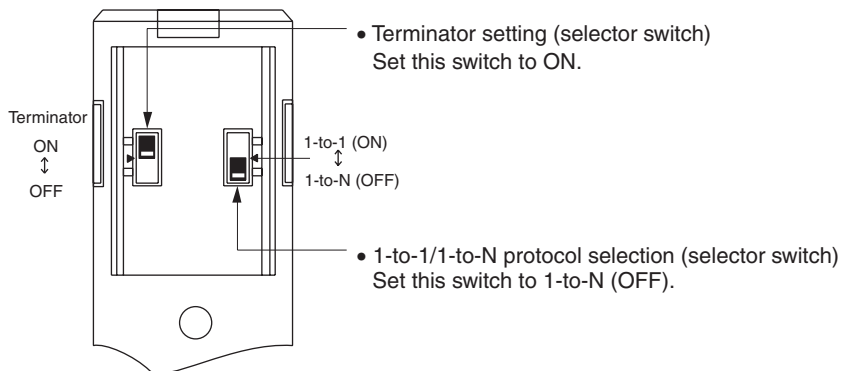

**C1000H/C2000H Rack-mounting Unit: 3G2A5-LK201-EV1**

**Setting the Front Switches**

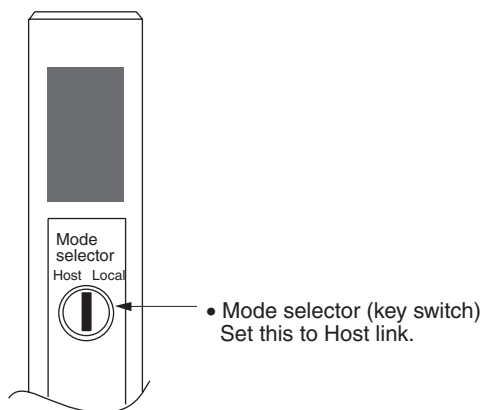

Setting the Rear Switches

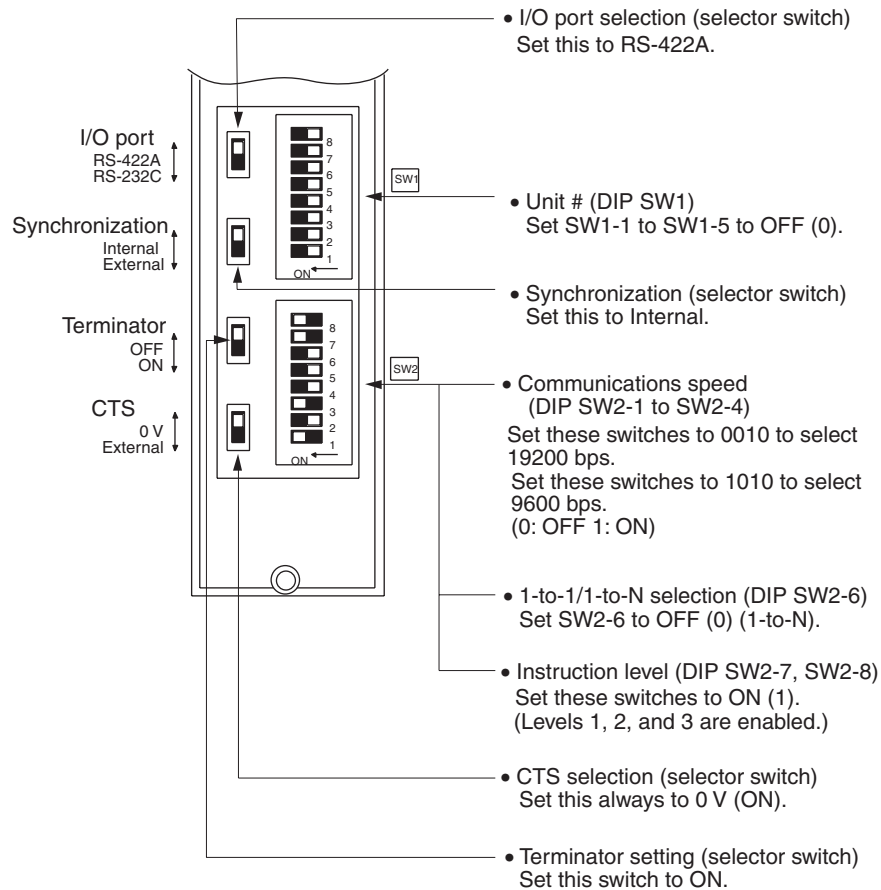

**C1000H/C2000H Rack-mounting Unit: C500-LK203**

**Setting the Rear Switches**

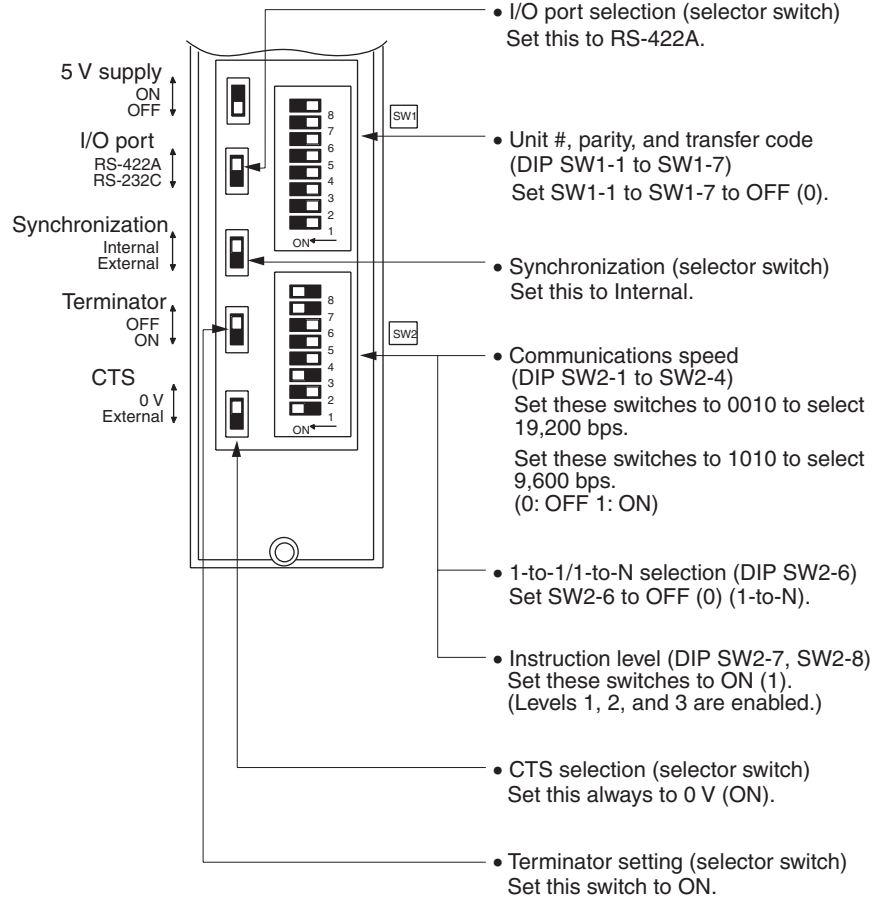

**C200H/C1000H/C2000H CPU-mounting Unit: 3G2A6-LK202-EV1**

**Setting the Rear Switches**

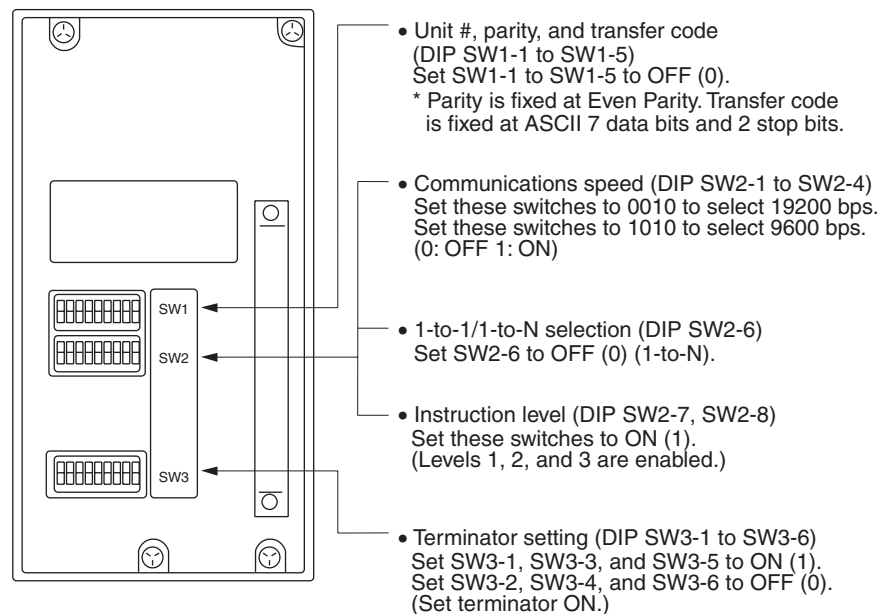

**Connecting to a CVM1/CV-series Host Link Unit**

**CVM1/CV-series Rack-mounting Unit: CV500-LK201**

A CVM1/CV-series Host Link Unit (CV500-LK201) has two connectors (communications ports 1 and 2). To use the RS-422A host link method, set communications port 2 to RS-422A.

Communications port 2 is a 9-pin connector which allows selection of the RS-232C or RS-422A method. When this port is used with the RS-422A method, the I/O port selector switch on the front of the Unit must be set to RS-422A (the lower position).

**CPU Bus Unit Settings**

When connecting to a CVM1/CV-series Host Link Unit, set the following communications conditions for the CPU Bus Unit settings.

| Item                 | Setting at Host                                  |
|----------------------|--|
| Communications speed | Set the same speed as for the NT631/NT631C. (*1) |
| Transfer code        | ASCII, 7 data bits, 2 stop bits                  |
| Parity               | Even   |
| 1-to-1/1-to-N        | 1-to-N(*2)                                       |
| Instruction level    | Level 1, 2, 3                                    |

\*1 Set the host link communications speed at 9600 bps or 19200 bps with the Comm. Speed memory switch at the NT631/NT631C. For details, refer to 6-7-2 *Setting the Host Link Method* (page 155).

\*2 The 1-to-N setting enables BCC (Block Check Character). It is not actually possible to connect more than one NT631/NT631C in a single host link.

Set the CPU Bus Unit settings directly from a Programming Device (e.g. CX-Programmer).

For details on the CPU Bus Unit settings, refer to the *SYSMAC CVM1/CV-series Host Link Unit Operation Manual* (W205-E1-□).

**Setting the Front Switches**

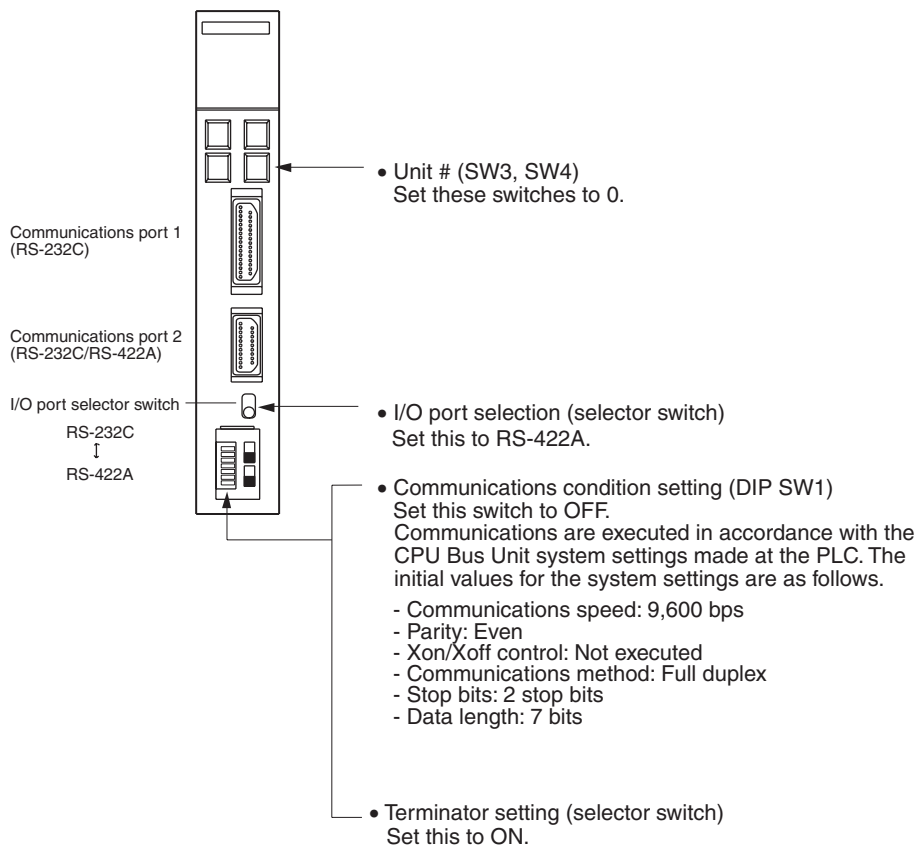

**Connecting to a CPU Unit**

**CVM1/CV-series (-EV□) CPU Units**

- CV500-CPU01-EV1/CV1000-CPU01-EV1/CV2000-CPU01-EV1
- CVM1-CPU01-EV2/CVM1-CPU11-EV2/CVM1-CPU21-EV2

**PLC Setup**

When connecting to a CVM1/CV-series CPU Unit, set the following communications conditions for the PLC Setup.

| Item                 | Setting at Host                                  |
|----------------------|--|
| Communications speed | Set the same speed as for the NT631/NT631C. (*1) |
| Stop bit             | 2 stop bits                                      |
| Parity               | Even   |
| Data length          | ASCII 7 bits                                     |
| Unit #               | 00   |

\*1 Set the host link communications speed at 9600 bps or 19200 bps with the Comm. Speed memory switch at the NT631/NT631C. For details, refer to 6-7-2 Setting the Host Link Method (page 155).

Either set the PLC Setup directly from a Programming Device (e.g. CX-Programmer), or transmit the PLC Setup made at a Programming Device to the CPU Unit.

For details on the PLC Setup, refer to the *SYSMAC CVM1/CV500/CV1000/CV2000 Operation Manual: Ladder Diagrams (W202-E1-□)*.

**Setting the Front Switches**

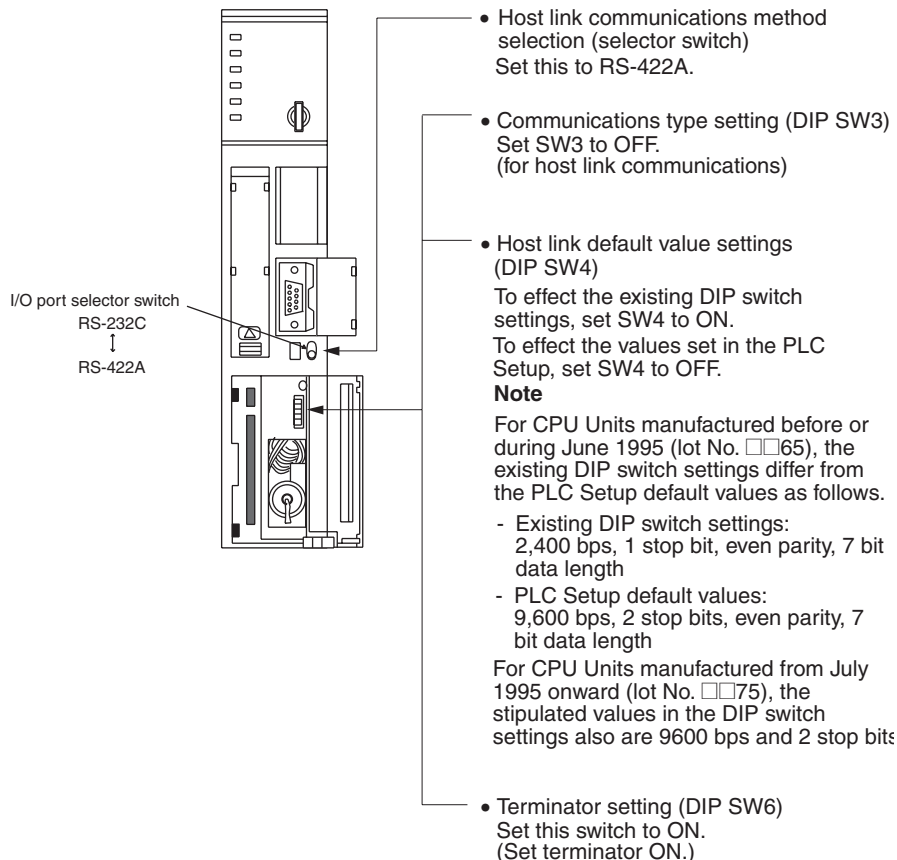

**C200HX/HG/HE(-Z)E, CPM1, CPM2A, CPM2C, CQM1H, or SRM1**

The connection method depends upon the model of PLC being used, as shown in the following table.

| PLC model         | Connection method  |
|-------------------|--|
| C200HX/HG/HE(-Z)E | Connect to the RS-422A port (port A) on a Communications Board.  |
| CQM1H             | Connect to the RS-422A port (port 2) on a Serial Communications Board.   |
| CPM1              | Connect to the peripheral port through a CPM1-CIF11 RS-422A Adapter.   |
| CPM2A, SRM1       | Connect to the peripheral port through a CPM1-CIF11 RS-422A Adapter.   |
| CPM2C             | Connect to the peripheral port (on a CPM2C-CN111 or CS1W-CN114 Connecting Cable) through a CPM1-CIF11 RS-422A Adapter.<br><br>(The CPM2C-CN111 splits the Unit's Communications Port into a RS-232C port and a peripheral port.) |

- Reference:**
- There are no Communications Boards for the C200HX/HG/HE(-Z)E in which port B is the RS-422A port.
  - There are no Serial Communications Boards for the CQM1H in which port 1 is the RS-422A port.



**PLC Setup Area Settings**

When connecting to a C200HX/HG/HE(-Z)E or CPM1, CPM2A, CPM2C, CQM1H CPU Units or SRM1, set the following communications conditions for the PLC Setup area.

| Item                 | Setting at Host                                  |
|----------------------|--|
| I/O port             | RS-422A  |
| Communications mode  | Host link mode                                   |
| Communications speed | Set the same speed as for the NT631/NT631C. (*1) |
| Stop bit             | 2 stop bits                                      |
| Parity               | Even   |
| Data length          | ASCII 7 bits                                     |
| Unit #               | 00   |

\*1 Set the host link communications speed at 9600 bps or 19200 bps with the Comm. Speed at the NT631/NT631C. For details, refer to *6-7-2 Setting the Host Link Method* (page 155).

Set the PLC Setup area settings directly from a Programming Device (e.g. CX-Programmer).

For details on operations relating to the PLC Setup area, refer to the manual for the PLC which is used.

The PLC Setup area word numbers and settings to be made depending on the Unit to which the connection is made are shown below.

When using port A of the Communications Board of C200HX/HG/HE(-Z)E

| Word # | Setting | Setting Contents  |
|--------|---------|---|
| DM6555 | 0001    | Host link mode, no CTS control<br>Communications conditions set by the contents of DM |
| DM6556 | 0303    | Data length 7 bits, 2 stop bits, even parity, communications speed: 9600 bps          |
|        | 0304    | Data length 7 bits, 2 stop bits, even parity, communications speed: 19200 bps         |
| DM6558 | 0000    | Unit # 00   |

When using a CPM1, CPM2A, CPM2C, SRM1

| Word # | Setting | Setting Contents  |
|--------|---------|---|
| DM6650 | 0001    | Host link mode, no CTS control<br>Communications conditions set by the contents of DM |
| DM6651 | 0303    | Data length 7 bits, 2 stop bits, even parity, communications speed: 9600 bps          |
|        | 0304    | Data length 7 bits, 2 stop bits, even parity, communications speed: 19200 bps         |
| DM6653 | 0000    | Unit # 00   |

When using a CQM1H

| Word # | Setting | Setting Contents  |
|--------|---------|---|
| DM6550 | 0001    | Host link mode, no CTS control<br>Communications conditions set by the contents of DM |
| DM6551 | 0303    | Data length 7 bits, 2 stop bits, even parity, communications speed: 9600 bps          |
|        | 0304    | Data length 7 bits, 2 stop bits, even parity, communications speed: 19200 bps         |
| DM6553 | 0000    | Unit # 00   |

**Connecting to a CPM2C**

The CPM2C PLCs do not have the same kind of port connectors found on CS/CJ-series PLCs. The CPM2C's communications port handles both RS-232C and peripheral port connections which are divided internally. Therefore, when using the CPM2C, it is necessary to select RS-232C or peripheral port connections, according to the kind of cable and port (on the cable) used, as shown in the following table. Refer to the *CPM2C Operation Manual* for more details.

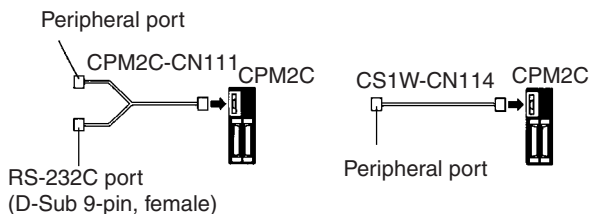

**Setting Switches on a C200HX/HG/HE(-Z)E Communications Board**

Set the switches on a C200HX/HG/HE(-Z)E Communications Board as follows.

Switch 1:  4 (4-wire = RS-422A)

Switch 2: ON (terminator ON = terminating resistance enabled)

**Setting Switches on a CQM1H Serial Communications Board**

Set the switches on a CQM1H Serial Communications Board as follows.

2-wire or 4-wire selector (WIRE):  4 (4-wire = RS-422A)

Terminating resistance switch (TERM): ON (terminator ON = terminating resistance enabled)

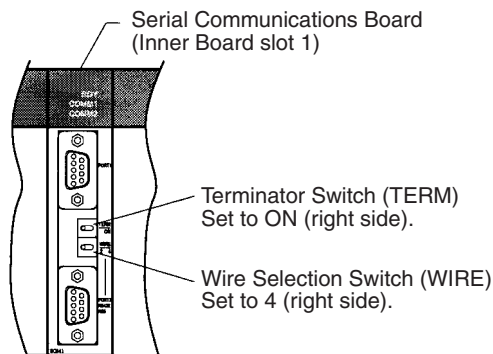

**Setting the Switches on an RS-422A Adapter**

Set the terminator selector switch to ON (upper position).

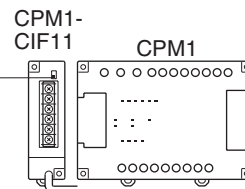

**Connecting to a CS-series Serial Communications Board**

Serial Communications Board with RS-422A/485 port equipped for CS-series CPU Unit:

CS1W-SCB41(-V1) (The port 2 is an RS-422A/485 port.)

**Serial Communications Board Switch Settings**

Set the switches on the Serial Communications Board as shown below.

2-wire or 4-wire selector (WIRE):  4 (4-wire = RS-422A)

Terminating resistance switch (TERM): ON (terminator ON = terminating resistance enabled).

**Allocation DM Area Settings for CPU Unit**

Settings are written from the Programming Device (a Programming Console or CX-Programmer) directly into the allocation DM area (system setting area) of the CPU Unit. After the settings are written, they become effective by turning the power ON, restarting the Unit, restarting the communications port, or executing the STUP command.

In the following, the channel numbers of the allocation DM area and the settings are shown.

| Allocated DM Area words | Setting | Setting Contents  |
|-------------------------|---------|---|
| <b>Port 2</b>           |         |   |
| DM32010                 | 8000    | Host link mode, 2 stop bits, data length 7 bits, even parity, |
| DM32011                 | 0000    | Communications speed: 9600 bps                                |
|                         | 0007    | Communications speed:19200 bps                                |
| DM32012                 | 0000    | Transmit delay time0 ms.                                      |
| DM32013                 | 0000    | No CTS control Unit, No.0 for host link                       |

**Connecting to a CS/CJ-series Serial Communications Unit**

CS/CJ-series Rack-mounting Units:

CS1W-SCU31-V1 (Port 1 and port 2 are both RS-422A/485 ports.)

CJ1W-SCU31-V1 (Port 1 and port 2 are both RS-422A/485 ports.)

CJ1W-SCU41(-V1) (Port 1 is an RS-422A/485 port.)

**Setting the Front Switches**

Set the unit number of the Serial Communications Unit using the rotary switches on the front of the Unit. Set the number or symbol in the setting display window in the following way using a flat-blade screwdriver. When using a CS/CJ-series Serial Communications Unit set the switches as shown below.

2-wire or 4-wire selector (WIRE):  4 (4-wire = RS-422A)

Terminating resistance switch (TERM): ON (terminator ON = terminating resistance enabled).

**DM Area Allocation Settings**

From the Programming Device (i.e., a Programming Console or CX-Programmer), write the settings directly to the CPU Unit's DM Area Setup Area. After the settings have been written, they will be enabled when the power supply is cycled, the Unit is restarted, the communications port is restarted, or a STUP instruction is executed.

The DM Area words that are allocated and the contents of the settings are given in the following table.

$$m = DM\ 30000 + 100 \times \text{unit number}$$

| Allocated DM Area words |        | Setting | Setting Contents   |
|-------------------------|--------|---------|--|
| Port 1                  | Port 2 |         |  |
| m                       | m+10   | 8000    | Host link mode, 2 stop bits, even parity, data length 7 bits |
| m+1                     | m+11   | 0000    | Communications speed: 9600 bps                               |
|                         |        | 0007    | Communications speed: 19200 bps                              |
| m+2                     | m+12   | 0000    | Transmit delay time 0 ms                                     |
| m+3                     | m+13   | 0000    | No CTS control Unit, No.0 for host link                      |

**Using the NT Link (1:1) Method**

**Compatible Host Units**

Some models and series of OMRON PLCs have the RS-422A NT Link (1:1) function built in.

- The C200HX/HG/HE(-Z)E CPU Units can be connected by the RS-422A NT Link (1:1) method by installing a Communications Board.
- The CQM1H CPU Units can be connected by the RS-422A NT Link (1:1) method by installing a Serial Communications Board.

Check the model and series of the PLC against the type of CPU Unit before making the connections.

The hosts that can be connected to the RS-422A port of the NT631/NT631C by the RS-422A NT Link (1:1) method are indicated in the table below.

| PLC Series                  | CPU Units with Built-in RS-422A NT Link (1:1) Function   | Model Name       |        |
|-----------------------------|--|------------------|--------|
| C Series                    | C200HE-CPU32-(Z)E <sup>(*1)</sup><br>C200HE-CPU42-(Z)E <sup>(*1)</sup>   | C200HE(-Z)E      |        |
|                             | C200HG-CPU33-(Z)E <sup>(*1)</sup><br>C200HG-CPU43-(Z)E <sup>(*1)</sup><br>C200HG-CPU53-(Z)E <sup>(*1)</sup><br>C200HG-CPU63-(Z)E <sup>(*1)</sup>   | C200HG(-Z)E      |        |
|                             | C200HX-CPU34-(Z)E <sup>(*1)</sup><br>C200HX-CPU44-(Z)E <sup>(*1)</sup><br>C200HX-CPU54-(Z)E <sup>(*1)</sup><br>C200HX-CPU64-(Z)E <sup>(*1)</sup><br>C200HX-CPU65-ZE <sup>(*1)</sup><br>C200HX-CPU85-ZE <sup>(*1)</sup> | C200HX(-Z)E      |        |
|                             | CQM1H-CPU51/61   | CQM1H            |        |
|                             | CV Series <sup>(*3)</sup>  | CV500-CPU01-EV1  | CV500  |
|                             |  | CV1000-CPU01-EV1 | CV1000 |
|                             |  | CV2000-CPU01-EV1 | CV2000 |
| CVM1 Series <sup>(*3)</sup> | CVM1-CPU01-EV2<br>CVM1-CPU11-EV2<br>CVM1-CPU21-EV2   | CVM1             |        |

\*1 One of the following Communications Boards is required:  
C200HW-COM03-EV1 or C200HW-COM06-EV1.

\*2 A CQM1H-SCB41-E Serial Communications Board is required.

\*3 CPU Units of CVM1/CV-series PLCs without the suffix -EV□ cannot be connected.

The NT Link (1:1) method cannot be used using RS-485. To use the NT Link (1:1) method, connect by RS-422A.

The 1:1 NT Link connection using RS-422A/485 is not possible with the CPM1, CPM2A, or CPM2C.

**Settings at the Host**

The setting methods for each type of Unit are described in the following.

- Connecting to a CVM1/CV-series (-EV□) CPU Units
  - CV500-CPU01-EV1/CV1000-CPU01-EV1/CV2000-CPU01-EV1
  - CVM1-CPU01-EV2/CVM1-CPU11-EV2/CVM1-CPU21-EV2

**PLC Setup**

When connecting to a CVM1/CV-series CPU Unit by the NT Link (1:1) method, no particular settings are required at the PLC Setup.

**Setting the Front Switches**

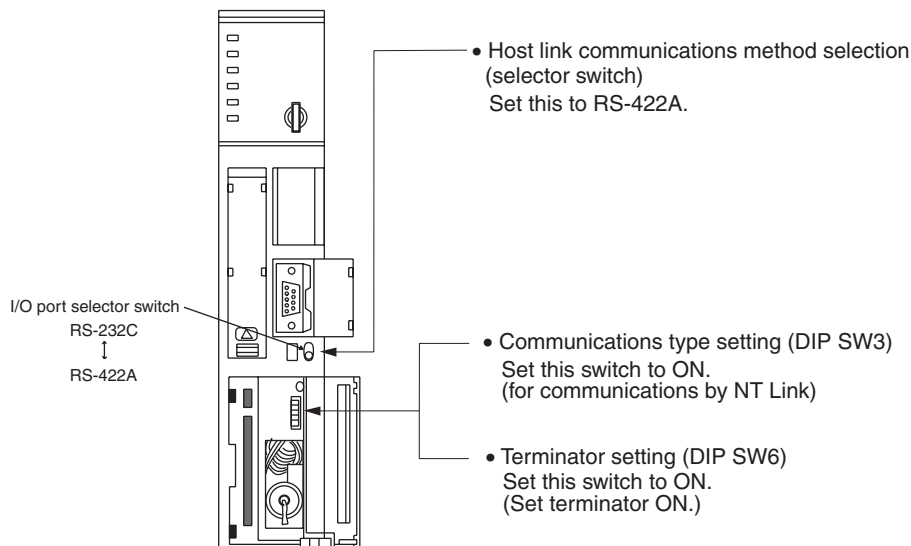

- Connecting to a C-series C200HX/HG/HE(-Z)E

**PLC Setup Area Settings**

Write the PLC Setup area (data memory) settings directly from a Programming Device (e.g. CX-Programmer) in accordance with the host model.

| Host Model                    | Word # | Setting | Setting Contents  |
|-------------------------------|--------|---------|-------------------|
| Port A of C200HX/HG/HE(-Z)E*1 | DM6555 | 4000    | Use NT Link (1:1) |
| Port 2 of CQM1H*2             | DM6550 | 4000    |                   |

\*1 RS-422A port of the Communications Board

\*2 RS-422A port of the Serial Communications Board

For details on operations relating to the PLC Setup area, refer to the manual for the PLC you are using.

**Setting the DIP Switches on a C200HX/HG/HE(-Z)E Communications Board**

Set the switches on a C200HX/HG/HE(-Z)E Communications Board as follows.

Switch 1:  4 (4-wire = RS-422A)

Switch 2: ON (terminator ON = terminating resistance enabled).

**Setting Switches on a CQM1H Serial Communications Board**

Set the switches on a CQM1H Serial Communications Board as follows.

2-wire or 4-wire selector (WIRE):  4 (4-wire = RS-422A)

Terminating resistance switch (TERM): ON (terminator ON = terminating resistance enabled).

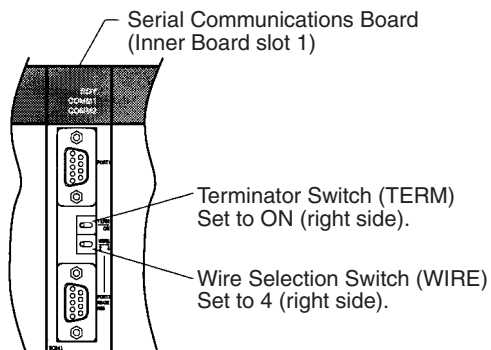

**Using the NT Link (1:N) Method**

**Compatible Host Units**

The OMRON PLCs that can be connected using the RS-422A/485 NT Link (1:N) method are the CS/CJ-series, C200HX/HG/HE(-Z)E, and CQM1H models only. A Serial Communications Board/Unit or a Communications Board must be installed to make the connection.

Check the model and series of the PLC against the type of CPU Unit or communications board before making the connections.

The hosts that can be connected to the RS-232C port of the NT631/NT631C by the RS-422A NT Link (1:N) function via an Adapter are indicated in the table below.

| PLC Series | CPU Units with Built-in NT Link (1:1) Function | CPU Unit that becomes connectable by installing a Communications Board/Unit | Model Name           |
|------------|--|---|----------------------|
| CS Series  |  | CS1G-CPU42/43/44/45-E(V1) <sup>(*1)</sup>                                   | CS1G<br>CS1H<br>CS1D |
|            |  | CS1H-CPU63/64/65/66/67-E(V1) <sup>(*1)</sup>                                |                      |
|            |  | CS1G-CPU42H/43H/44H/45H <sup>(*1)</sup>                                     |                      |
|            |  | CS1H-CPU63H/64H/65H/66H/67H <sup>(*1)</sup>                                 |                      |
|            |  | CS1D-CPU65H/67H <sup>(*2)</sup>   |                      |
| CJ Series  |  | CJ1G-CPU44/45 <sup>(*3)</sup>   | CJ1G<br>CJ1H<br>CJ1M |
|            |  | CJ1G-CPU42H/43H/44H/45H <sup>(*3)</sup>                                     |                      |
|            |  | CJ1H-CPU65H/66H/67H <sup>(*3)</sup>   |                      |
|            |  | CJ1M-CPU11/12/13/21/22/23 <sup>(*3)</sup>                                   |                      |

| PLC Series | CPU Units with Built-in NT Link (1:1) Function | CPU Unit that becomes connectable by installing a Communications Board/Unit  | Model Name   |
|------------|--|--|--------------|
| C Series   |  | C200HE-CPU32-(Z)E <sup>(*4)</sup><br>C200HE-CPU42-(Z)E <sup>(*4)</sup>   | C200HE (-Z)E |
|            |  | C200HG-CPU33-(Z)E <sup>(*4)</sup><br>C200HG-CPU43-(Z)E <sup>(*4)</sup><br>C200HG-CPU53-(Z)E <sup>(*4)</sup><br>C200HG-CPU63-(Z)E <sup>(*4)</sup>   | C200HG (-Z)E |
|            |  | C200HX-CPU34-(Z)E <sup>(*4)</sup><br>C200HX-CPU44-(Z)E <sup>(*4)</sup><br>C200HX-CPU54-(Z)E <sup>(*4)</sup><br>C200HX-CPU64-(Z)E <sup>(*4)</sup><br>C200HX-CPU65-ZE <sup>(*4)</sup><br>C200HX-CPU85-ZE <sup>(*4)</sup> | C200HX (-Z)E |
|            |  | CQM1H-CPU51/61 <sup>(*5)</sup>   | CQM1H        |

\*1 A CS1W-SCB41(-V1) Serial Communications Board or CS1W-SCU31-V1 Serial Communications Unit is required.

\*2 This CPU Unit is for a Duplex-CPU Unit System. The CS1W-SCB41(-V1) Serial Communications Board cannot be used. Use the CS1W-SCU31-V1 Communications Unit.

\*3 A CS1W-SCU31-V1 or CS1W-SCU41(-V1) Serial Communications Unit is required.

\*4 A C200HW-COM03-V1 or C200-COM06-V1 Communications Board is required.

\*5 A CQM1H-SCB41 Serial Communications Board is required.

**Settings at the Host**

C-series C200HX/HG/HE(-Z)E

**PLC Setup Area Settings**

Write the communications conditions directly into the PLC Setup area (data memory) using a Programming Device (e.g. CX-Programmer).

Make the setting indicated in the word shown below.

| Connection to                               | Word # | Setting | Setting Contents   |
|---|--------|---------|--|
| Port A of a C200HX/HG/HE(-Z)E <sup>*1</sup> | DM6555 | 5□00    | Use NT Link (1:N)<br>□ = highest unit number of the connected PTs (1 to 7) <sup>*3</sup> |
| Port 2 of a CQM1H <sup>*2</sup>             | DM6550 | 5□00    |  |

\*1 The Communications Board's RS-422A/485 port

\*2 The Serial Communications Board's RS-422A/485 port

\*3 When using C200HE(-Z)E, the maximum PT unit number is 3.

For details on setting the PLC Setup area settings, refer to the PLC's operation manual.

- Reference:**
- There are no Serial Communications Boards for the C200HX/HG/HE(-Z)E in which port B is the RS-422A/485 port.
  - There are no Serial Communications Boards for the CQM1H in which port 1 is the RS-422A/485 port.

**Setting the DIP Switches on a C200HX/HG/HE(-Z)E Communications Board**

Set the switches on a C200HX/HG/HE(-Z)E Communications Board as follows.

- Switch 1:  4 (4-wire = RS-422A), or  2 (2-wire = RS-485)
- Switch 2: ON (terminator ON = terminating resistance enabled).

**Setting Switches on a CQM1H Serial Communications Board**

Set the switches on a CQM1H Serial Communications Board as follows.

- 2-wire or 4-wire selector (WIRE):  4 (4-wire = RS-422A), or  2 (2-wire = RS-485)
- Terminating resistance switch (TERM): ON (terminator ON = terminating resistance enabled).

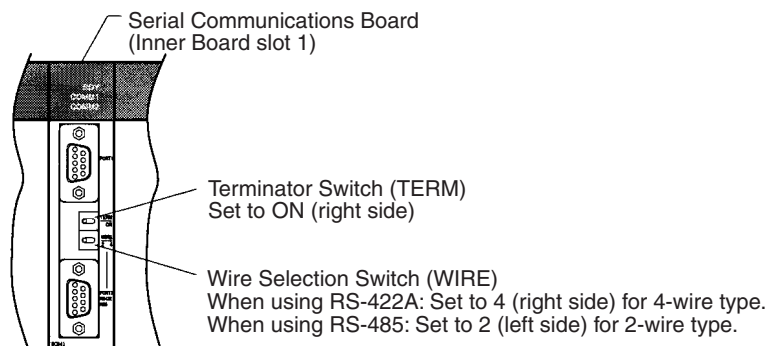

**Connecting to CS-series Serial Communications Board**

Serial Communications Board with RS-422A/485 port equipped for CS-series CPU Unit:

CS1W-SCB41(-V1) (Port 2 is an RS-422A/485 port.)

**Setting the Front Switches**

- 2-wire or 4-wire selector (WIRE):  4 (4-wire = RS-422A), or  2 (2-wire = RS-485)
- Terminating resistance switch (TERM): ON (terminator ON = terminating resistance enabled).



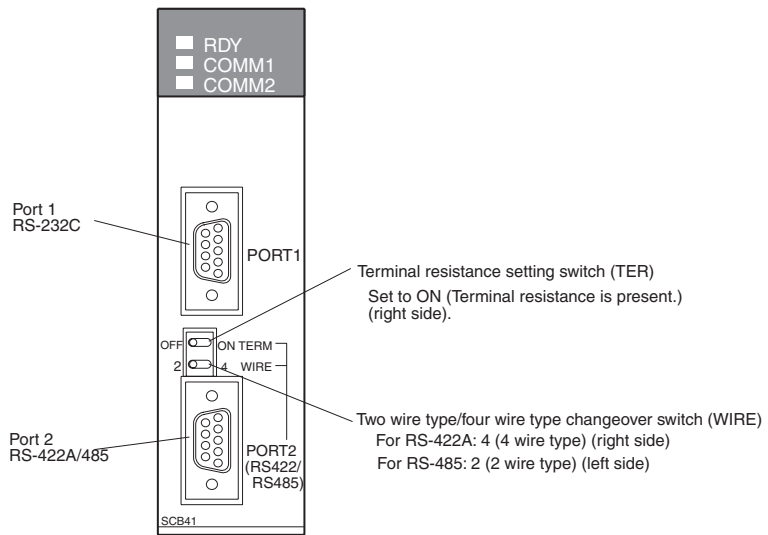

**Allocation DM Area Settings for CPU Unit**

Settings are written from the Programming Device (a Programming Console or CX-Programmer) directly into the allocation DM area (system setting area) of the CPU Unit. After settings are written, they become effective by turning the power ON, restarting the Unit, restarting the communications port, or executing the STUP command.

In the following, the channel numbers of the allocation DM area and settings are shown.

| Allocated DM Area words | Setting           | Setting Contents  |
|-------------------------|-------------------|---|
| <b>Port 2</b>           |                   |   |
| DM32010                 | 8200              | 1:N NT Link Mode  |
| DM32011                 | 0000 to 0009 (*1) | Baud rate (standard)                                      |
| DM32016                 | 000□              | □ = The highest unit number of the connected PTs (0 to 7) |

\*1 Set any value between 0000 and 0009 hex for the baud rate. The same baud rate will be used regardless of the value as long as it is between 0000 and 0009 hex.

For example, when connecting PTs with model numbers 3, 4, 5, and 6 to port 2 in the NT Link (1:N), set a value of 8200 hex for D32010, 0000 hex for DM32011, and 0006 hex for D32016.

**Connecting to a CS/CJ-series Serial Communications Unit**

CS/CJ-series Rack-mounting Units:

CS1W-SCU31-V1 (Port 1 and 2 are both RS-422A/485 ports.)

CJ1W-SCU31-V1 (Port 1 and 2 are both RS-422A/485 ports.)

CJ1W-SCU41(-V1) (Port 1 is an RS-422A/485 port.)

**Setting the Front Switches**

Set the unit number of the Serial Communications Unit using the rotary switches on the front of the Unit. Set the number or symbol in the setting display window in the following way using a flat-blade screwdriver. When using a CS/CJ-series Serial Communications Unit set the switches as shown below.

2-wire or 4-wire selector (WIRE):  4 (4-wire = RS-422A), or  
 2 (2-wire = RS-485)

Terminating resistance switch (TERM): ON (terminator ON = terminating resistance enabled).

**DM Area Allocation Settings**

From the Programming Device (i.e., a Programming Console or CX-Programmer), write the settings directly to the CPU Unit's DM Area Setup Area. After the settings have been written, they will be enabled when the power supply is cycled, the Unit is restarted, the communications port is restarted, or a STUP instruction is executed.

The DM Area words that are allocated and the contents of the settings are given in the following table.

m = DM 30000 + 100 × unit number

| Allocated DM Area words |        | Setting                      | Setting Contents   |
|-------------------------|--------|------------------------------|--|
| Port 1                  | Port 2 |                              |  |
| m                       | m+10   | 8200                         | 1:N NT Link Mode   |
| m+1                     | m+11   | 0000 to 0009 (*1)            | Baud rate (standard)   |
| m+6                     | m+16   | 000 <input type="checkbox"/> | <input type="checkbox"/> = The highest unit number of the connected PTs (0 to 7) |

\*1 Set any value between 0000 and 0009 hex for the baud rate. The same baud rate will be used regardless of the value as long as it is between 0000 and 0009 hex.

**Using the High-speed NT Link (1:N) Method**

**Compatible Host Units**

Only OMRON's CS/CJ-series PLCs support the high-speed 1:N NT Link through RS-422A/RS-485. The high-speed 1:N NT Link must be established through a Serial Communications Board/Unit. (Even CS/CJ-series Units without the "-V1" suffix can be connected via a high-speed 1:N NT Link by mounting a Serial Communications Board/Unit.)

Be sure to check the model number of the PLC and Board/Unit before trying to establish the high-speed 1:N NT Link.

The following table shows which CS-series PLCs can be connected to an NT631/NT631C with the high-speed 1:N NT Link through RS-422A/RS-485.

| PLC Series | CPU Units with Built-in NT Link (1:1) Function | CPU Unit that becomes connectable by installing a Communications Board/Unit | Model Name |
|------------|--|---|------------|
| CS Series  |  | CS1G-CPU42/43/44/45-E(V1)(*1)   | CS1G       |
|            |  | CS1H-CPU63/64/65/66/67-E(V1)(*1)  | CS1H       |
|            |  | CS1G-CPU42H/43H/44H/45H(*1)   | CS1D       |
|            |  | CS1H-CPU63H/64H/65H/66H/67H(*1)   |            |
|            |  | CS1D-CPU65H/67H(*2)   |            |
| CJ Series  |  | CJ1G-CPU44/45(*3)   | CJ1G       |
|            |  | CJ1G-CPU42H/43H/44H/45H(*3)   | CJ1H       |
|            |  | CJ1H-CPU65H/66H/67H(*3)   | CJ1M       |
|            |  | CJ1M-CPU11/12/13/21/22/23(*3)   |            |

\*1 A CS1W-SCB41(-V1) Serial Communications Board or CS1W-SCU31-V1 Serial Communications Unit is required.

\*2 This CPU Unit is for a Duplex-CPU Unit System. The CS1W-SCB41(-V1) Serial Communications Board cannot be used. Use the CS1W-SCU31-V1 Communications Unit.

\*3 A CS1W-SCU31-V1 or CS1W-SCU41(-V1) Serial Communications Unit is required.

**Settings at the Host**

**Connecting to a CS-series Serial Communications Board**

Serial Communications Board equipped with an RS-422A/485 port for CS-series CPU Units:

CS1W-SCB41(-V1) (Port 2 is an RS-422A/485 port.)

**Reference:** CS-series Serial Communications Boards and Units with lot number 991220 (12/20/99) and later support the high-speed 1:N NT Link. Boards and Units with earlier lot numbers **cannot** be used.

**Setting the Front Switches**

Set the switches on a Serial Communications Board as follows.

2-wire or 4-wire selector (WIRE):  4 (4-wire = RS-422A), or  2 (2-wire = RS-485)

Terminating resistance switch (TERM): ON (terminator ON = terminating resistance enabled).

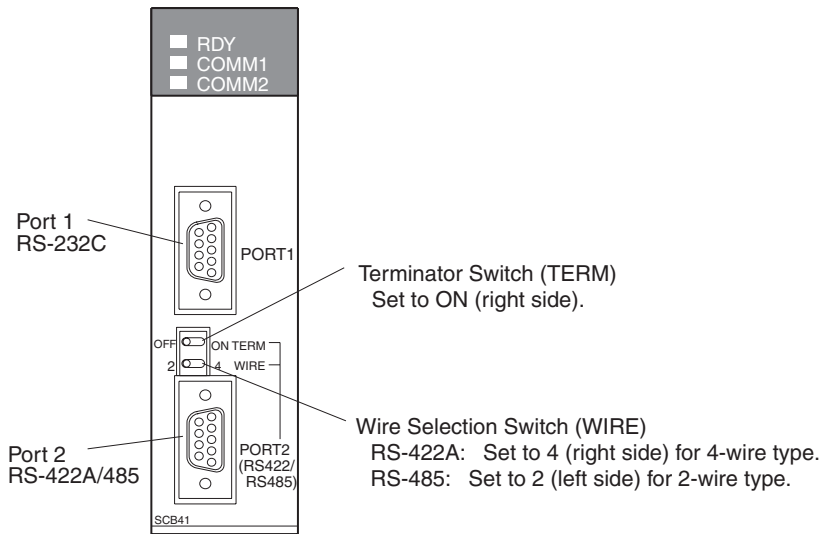

**Allocation DM area settings for CPU Unit**

Settings are written from the Programming Device (a Programming Console or CX-Programmer) directly into the allocation DM area (system setting area) of the CPU Unit. After settings are written, they become effective by turning the power ON, restarting the Unit, restarting the communications port, or executing the STUP command.

In the following table, the relevant word addresses in the allocation DM area and settings are shown.

| Allocated DM Area words | Setting | Setting Contents |
|-------------------------|---------|------------------|
| <b>Port 2</b>           |         |                  |
| DM32010                 | 8200    | 1:N NT Link Mode |

| Allocated DM Area words |        | Setting | Setting Contents  |
|-------------------------|--------|---------|---|
| Port 1                  | Port 2 |         |   |
|                         |        | 000A    | Baud rate (standard)                                      |
|                         |        | 000□    | □ = The highest unit number of the connected PTs (0 to 7) |

\*1 For example, when connecting PTs with model numbers 3, 4, 5, and 6 to port 2, set the value 8200 hex to DM32010, 000A hex to DM32011, and 0006 hex to DM32016.

**Connecting to a CS/CJ-series Serial Communications Unit**

CS/CJ-series Rack-mounting Units:

CS1W-SCU31-V1 (Port 1 and 2 are RS-422A/485 port.)

CJ1W-SCU31-V1 (Port 1 and 2 are RS-422A/485 port.)

CJ1W-SCU41(-V1) (Port 1 is an RS-422A/485 port.)

**Setting the Front Switches**

Set the unit number of the Serial Communications Unit using the rotary switches on the front of the Unit. Set the number or symbol in the setting display window in the following way using a flat-blade screwdriver. When using a CS/CJ-series Serial Communications Unit set the switches as shown below.

2-wire or 4-wire selector (WIRE):  4 (4-wire = RS-422A), or  
 2 (2-wire = RS-485)

Terminating resistance switch (TERM): ON (terminator ON = terminating resistance enabled).

**DM Area Allocation Settings**

From the Programming Device (i.e., a Programming Console or CX-Programmer), write the settings directly to the CPU Unit's DM Area Setup Area. After the settings have been written, they will be enabled when the power supply is cycled, the Unit is restarted, the communications port is restarted, or a STUP instruction is executed.

The DM Area words that are allocated and the contents of the settings are given in the following table.

$$m = \text{DM } 30000 + 100 \times \text{unit number}$$

| Allocated DM Area words |        | Setting | Setting Contents  |
|-------------------------|--------|---------|---|
| Port 1                  | Port 2 |         |   |
| m                       | m+10   | 8200    | 1:N NT Link Mode  |
| m+1                     | m+11   | 000A    | Baud rate (standard)                                      |
| m+6                     | m+16   | 000□    | □ = The highest unit number of the connected PTs (0 to 7) |

**When using the Memory Link Method**

With the memory link method, the connection can be made to a personal computer and an FA computer with RS-422A.

When connecting to the host with the memory link method, it is necessary to create a program for the memory link at the host side.

The following are the communications conditions that can be used with the memory link method. For the host (a personal computer, an FA computer, etc.), its setting should be compatible to one of the communications conditions listed in the following table. Set the same communications conditions at the NT631/NT631C by the memory switch. (page 160).

| Item                 | Setting at Host                           |
|----------------------|---|
| Input/Output board   | RS-422A                                   |
| Communications speed | 1200, 2400, 4800, 9600, 19200, 38400 bps. |
| Data bits length     | 7 bits, 8 bits                            |
| Stop bits length     | 1 bit, 2 bits                             |
| Parity               | None, even, odd                           |
| Flow control         | None, XON/XOFF                            |

### 5-2-2 Direct Connection between RS-422A Ports at Both Units

The connection method in which the RS-422A ports of an NT631/NT631C and a host are connected is described here.

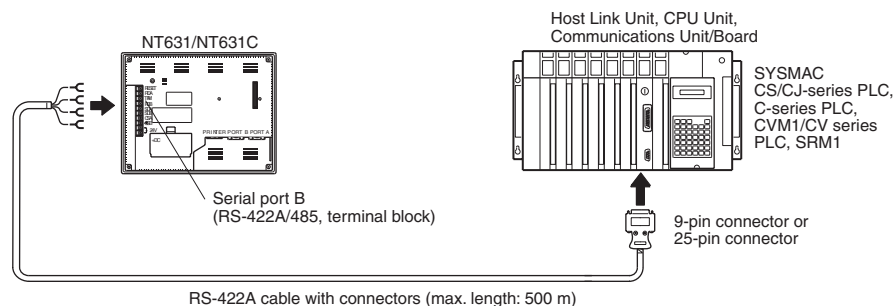

### Connecting an NT631/NT631C and Host (RS-422A)



### Wiring When Connecting a C-series Host Link Unit or CPM1 (Host Link)

Applicable Units:

- C200H-LK202-V1
- 3G2A5-LK201-EV1
- C500-LK203
- 3G2A6-LK202-EV1

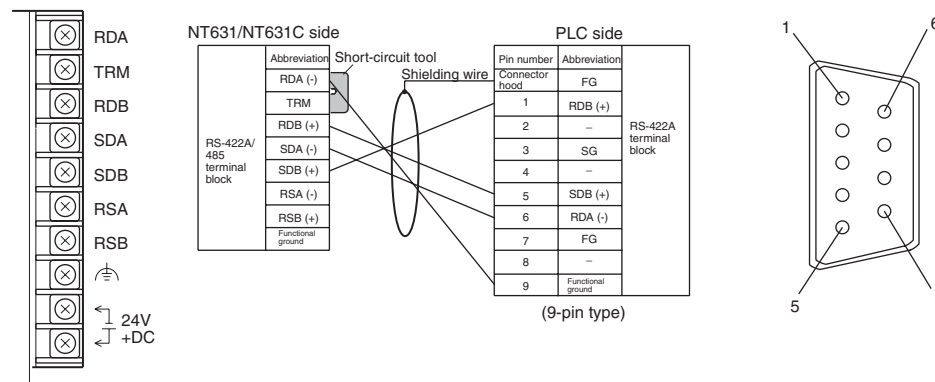

For details on handling shield wires, refer to 5-2-8 Handling the Shield on RS-422A/485 Cables on page 125.

**Wiring When Connecting CPM1, CPM2A, CPM2C, or SRM1**

Applicable Units:

- CPM1-10CDR-□
- CPM1A-10CD□-□
- CPM1A-30CD□-□
- CPM2A-30CD□□-□
- CPM2A-60CD□□-□
- CPM2C-10□□□□□□-□
- SRM1-C02-V2
- CPM1-20CDR-□
- CPM1A-20CD□-□
- CPM1A-40CD□-□
- CPM2A-40CD□□-□
- CPM2C-20□□□□□□-□

Connect to the PLC through a CPM1-CIF11 RS-422A Adapter.

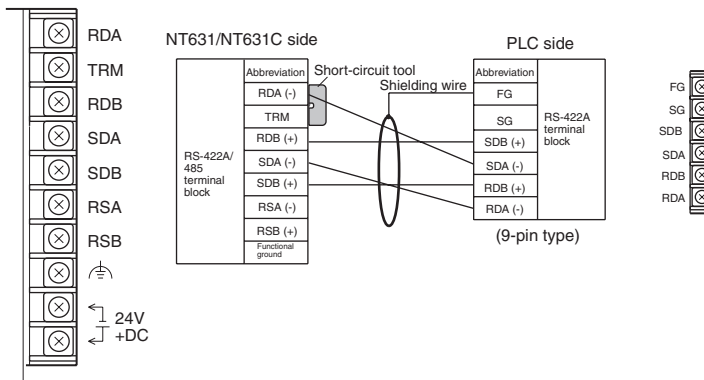

For details on handling shield wires, refer to 5-2-8 Handling the Shield on RS-422A/485 Cables on page 125.

**Wiring When Connecting a CS-series Serial Communications Board, CS/CJ-series Serial Communications Unit, C-series C200HX/HG/HE(-Z)E Communications Board, CQM1H Serial Communications Board, or CVM1/CV-series Host Link Unit**

Applicable Units:

- CS1W-SCU31-V1
- CJ1W-SCU31-V1/CJ1W-SCU41(-V1)
- CS1G-CPU42/43/44/45-E(V1)
- CS1H-CPU63/64/65/66/67-E(V1)
- CS1G-CPU42H/43H/44H/45H
- CS1H-CPU63H/64H/65H/66H/67H
- CS1D-CPU66H/67H (See note.)
- C200HE-CPU32/42-(Z)E
- C200HG-CPU33/43/53/63-(Z)E
- C200HX-CPU34/44/54/64-(Z)E
- C200HX-CPU65-ZE/85-ZE
- CQM1H-CPU51/61
- CV500-LK201 (communications port 2)

**Note** A Serial Communications Board cannot be installed.

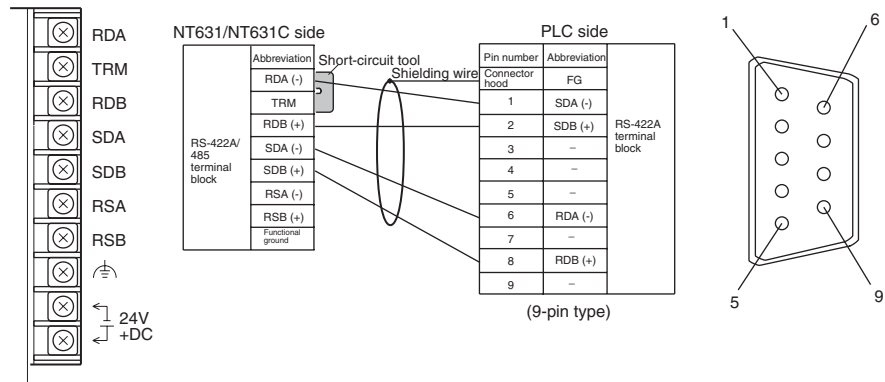

For details on handling shield wires, refer to 5-2-8 Handling the Shield on RS-422A/485 Cables on page 125.

**Wiring When Connecting a CVM1/CV-series CPU Unit**

Applicable Units:

- CV500-CPU01-EV1
- CV2000-CPU01-EV1
- CVM1-CPU01-EV□
- CVM1-CPU21-EV□
- CV1000-CPU01-EV1
- CVM1-CPU11-EV□

CVM1/CV-series CPU Units whose model names do not have the suffix -EV□ cannot be connected by any connection method.

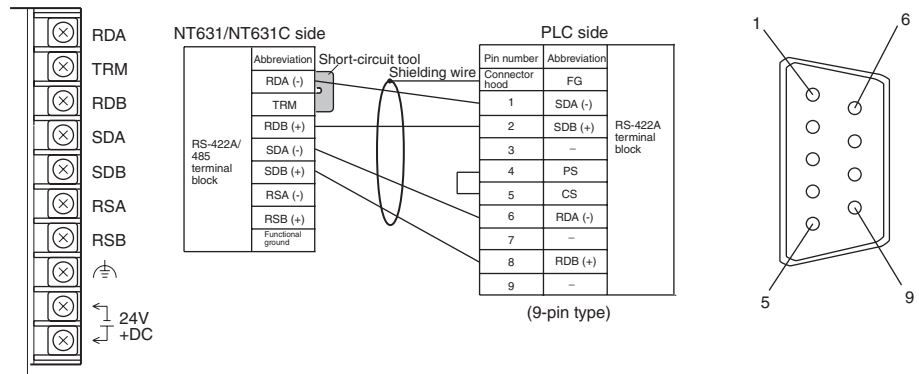

For details on handling shield wires, refer to 5-2-8 Handling the Shield on RS-422A/485 Cables on page 125.

**Wiring for a Memory Link Connection**

Prepare the adapter cable while referring to the following diagram.

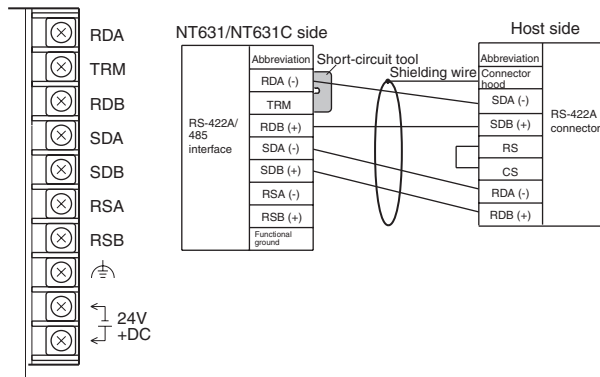

For details on handling shield wires, refer to 5-2-8 Handling the Shield on RS-422A/485 Cables on page 125.

### 5-2-3 Direct Connection between RS-485 Ports at Both Units

The connection method in which the RS-485 ports of an NT631/NT631C and a host are connected is described here.

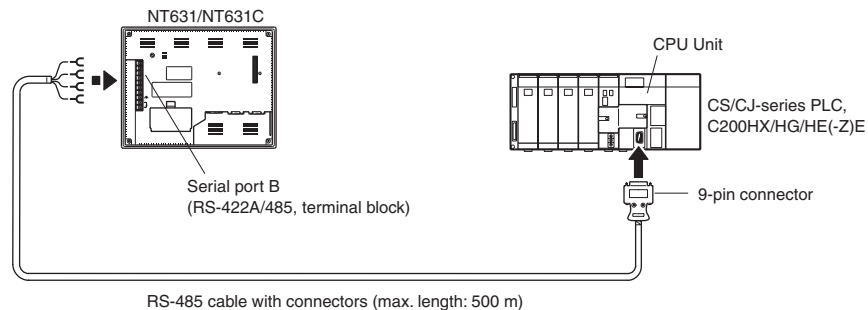

**Reference:** When RS-485 is used at the PT side, only the NT Link (1:N) method (standard or high-speed) can be used.

#### Connecting an NT631/NT631C and Host



#### Wiring When Connecting a CS-series Serial Communications Board, CS/CJ-series Serial Communications Unit, C-series C200HX/HG/HE(-Z)E Communications Board, or CQM1H Serial Communications Board

Applicable Units:

- CS1W-SCU31-V1
- CJ1W-SCU31-V1/CJ1W-SCU41(-V1)
- CS1G-CPU42/43/44/45-E(V1)
- CS1H-CPU63/64/65/66/67-E(V1)
- CS1G-CPU42H/43H/44H/45H
- CS1H-CPU63H/64H/65H/66H/67H
- CS1D-CPU66H/67H (See note.)
- C200HE-CPU32/42-(Z)E
- C200HG-CPU33/43/53/63-(Z)E
- C200HX-CPU34/44/54/64-(Z)E
- C200HX-CPU65-ZE/85-ZE
- CQM1H-CPU51/61

**Note** A Serial Communications Board cannot be installed.

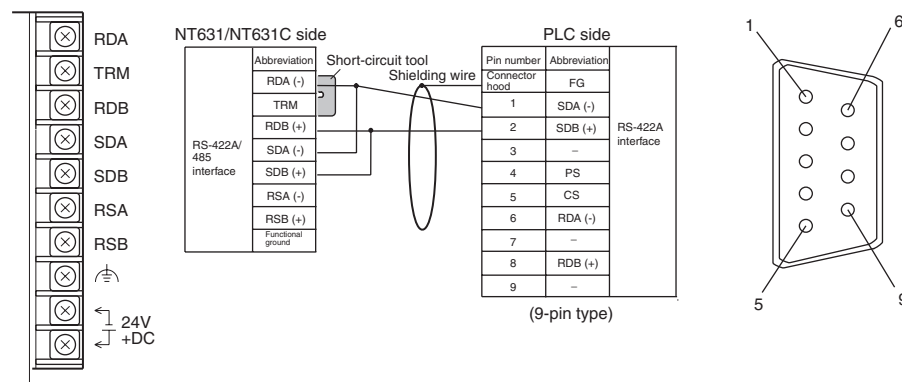

For details on handling shield wires, refer to 5-2-8 Handling the Shield on RS-422A/485 Cables on page 125.



### 5-2-4 1:N Connection among RS-422A Ports

The connection method in which the RS-422A ports of multiple NT631/NT631Cs and one host are connected in a 1:N connection is described here.

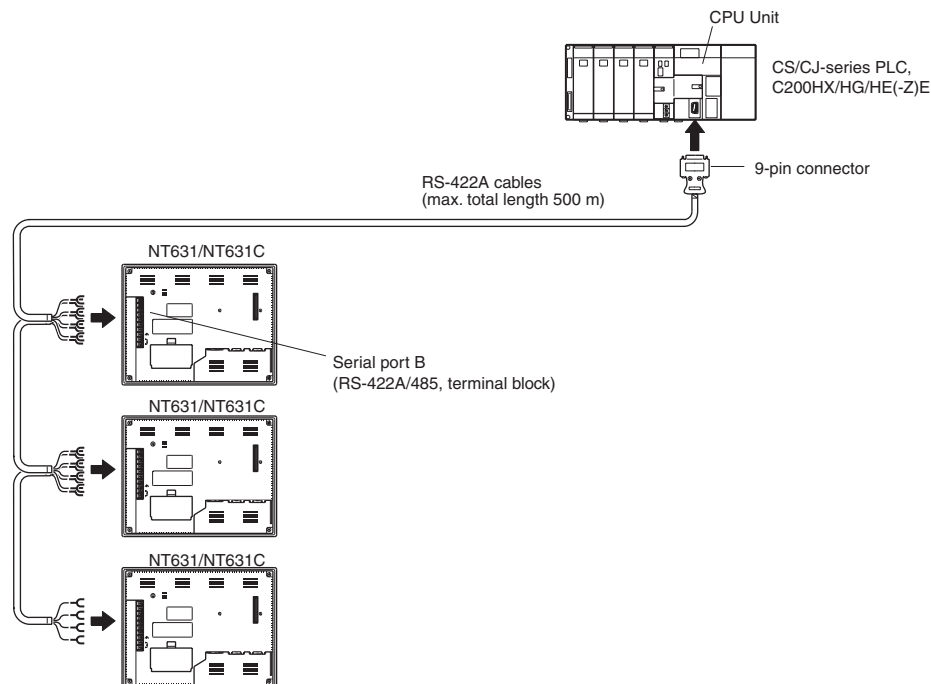

**Reference:**

- Communications using the RS-422A standard NT link (1:N) method is possible only when a Serial Communications Board is installed in a CS-series PLC, a Serial Communications Unit is installed in a CS/CJ-series PLC, a Communications Board is installed in a C200HX/HG/HE(-Z)E, or a CQM1H-SCB41 Serial Communications Board is installed in a CQM1H.
- Communications using the RS-422A high-speed NT link (1:N) method is possible only when a Serial Communications Board is installed in a CS-series PLC or a Serial Communications Unit is installed in a CS/CJ-series PLC.

Connecting between NT631/NT631C Units

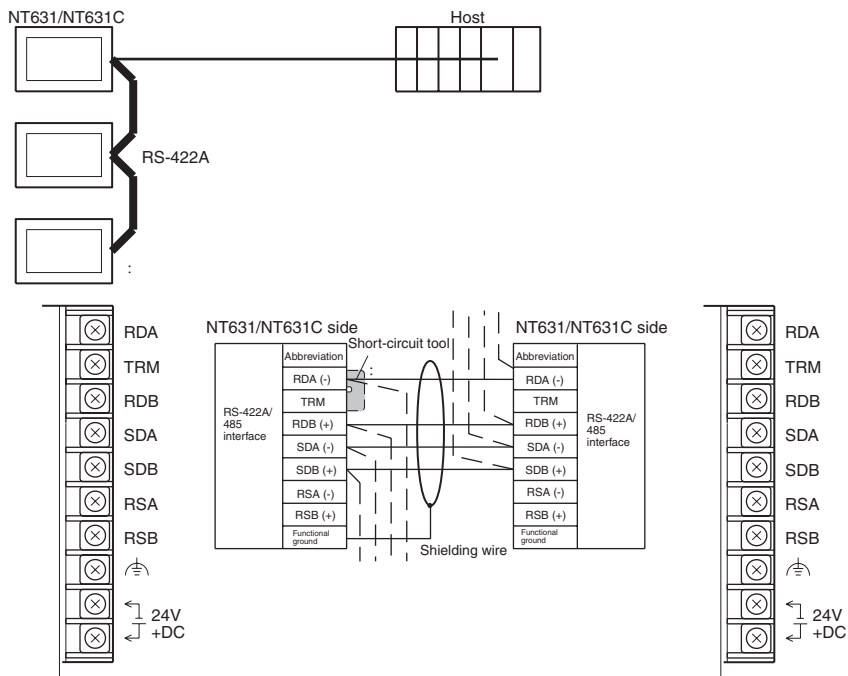

\* Short TRM and RDA terminals of the NT631/NT631C at the end of the RS-422A cable (\* marked in the above figure) using the short-circuit tool supplied with the NT631/NT631C.

For details on handling shield wires, refer to 5-2-8 Handling the Shield on RS-422A/485 Cables on page 125.

Connecting an NT631/NT631C and a Host

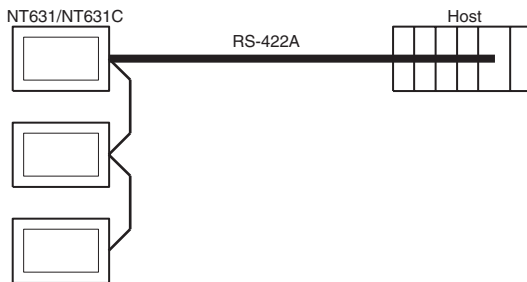

**Wiring When Connecting a CS-series Serial Communications Board, CS/C-series Serial Communications Unit, C-series C200HX/HG/HE(-Z)E Communications Board, or CQM1H Serial Communications Board**

Applicable Units:

- CS1W-SCU31-V1
- CJ1W-SCU31-V1/CJ1W-SCU41(-V1)
- CS1G-CPU42/43/44/45-E(V1)
- CS1H-CPU63/64/65/66/67-E(V1)
- CS1G-CPU42H/43H/44H/45H
- CS1H-CPU63H/64H/65H/66H/67H
- CS1D-CPU66H/67H (See note.)
- C200HE-CPU32/42-(Z)E
- C200HG-CPU33/43/53/63-(Z)E
- C200HX-CPU34/44/54/64-(Z)E

C200HX-CPU65-ZE/85-ZE  
CQM1H-CPU51/61

**Note** A Serial Communications Board cannot be installed.

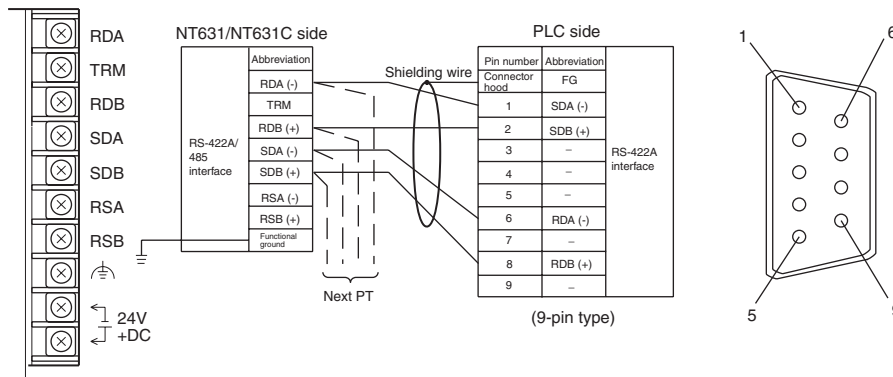

For details on handling shield wires, refer to 5-2-8 Handling the Shield on RS-422A/485 Cables on page 125.

### 5-2-5 1:N Connection among RS-485 Ports

The connection method in which the RS-485 ports of multiple NT631/NT631Cs and one host are connected in a 1:N connection is described here.

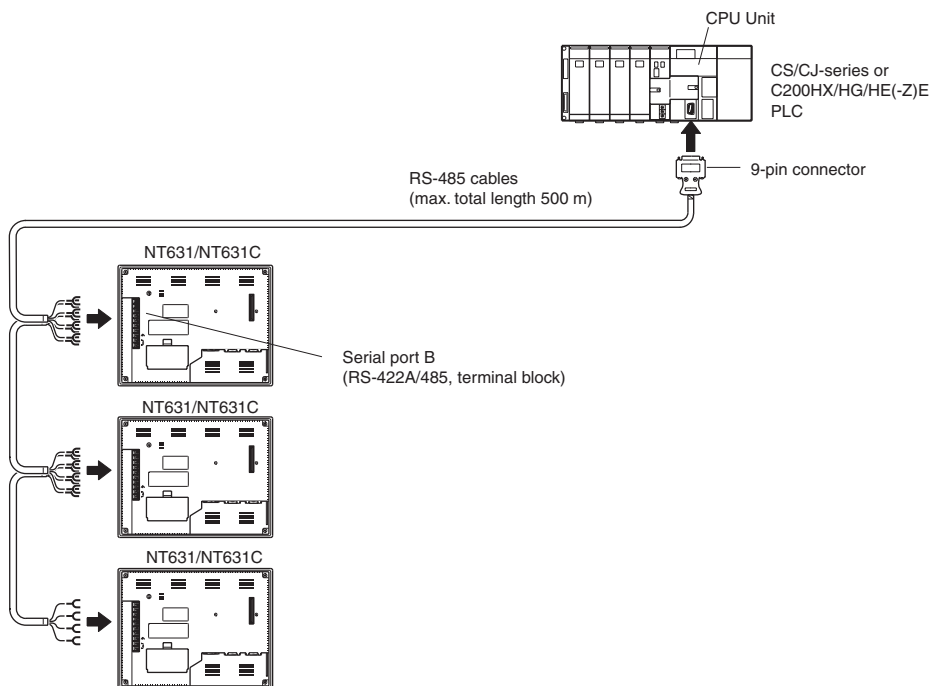

**Reference:**

- Communications using the RS-485A standard NT link (1:N) method is possible only when a Serial Communications Board is installed in a CS-series PLC, a Serial Communications Unit is installed in a CS/CJ-series PLC, a Communications Board is installed in a C200HX/HG/HE(-Z)E, or a CQM1H-SCB41 Serial Communications Board is installed in a CQM1H.
- Communications using the RS-485A high-speed NT link (1:N) method is possible only when a Serial Communications Board is installed in a CS-series PLC or a Serial Communications Unit is installed in a CS/CJ-series PLC.

Connecting between NT631/NT631C Units

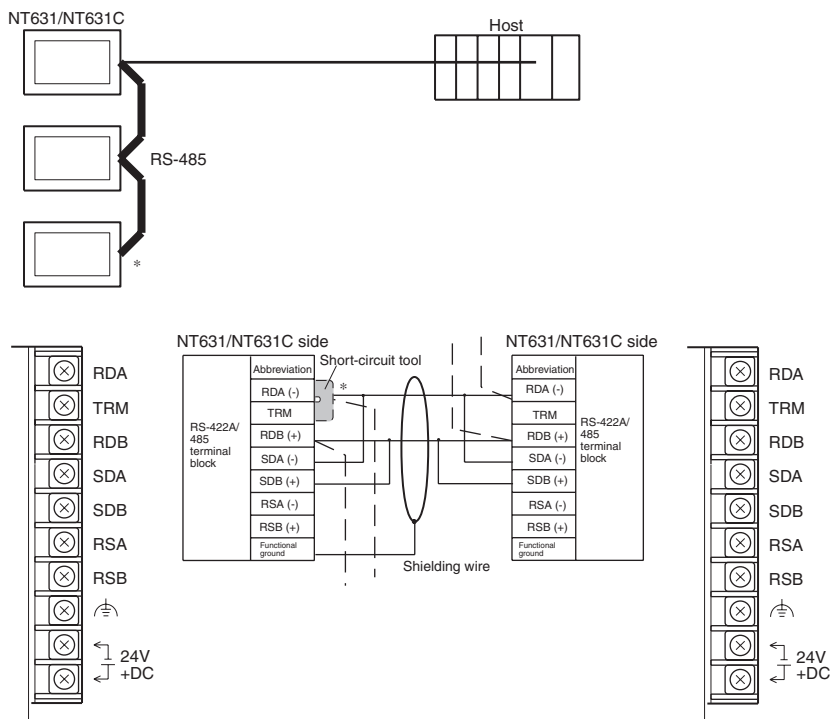

\* Short TRM and RDA terminals of the NT631/NT631C at the end of the RS-485 cable (\* marked in the above figure) using the short-circuit tool supplied with the NT631/NT631C.

For details on handling shield wires, refer to 5-2-8 Handling the Shield on RS-422A/485 Cables on page 125.

Connecting an NT631/NT631C and a Host

The relay terminal block is not included in this figure. Insert the relay terminal block so as to achieve the wiring configuration shown below.

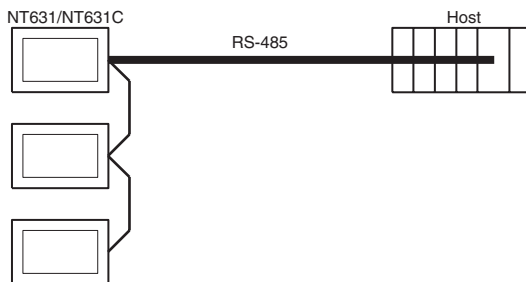

**Wiring When Connecting a CS-series Serial Communications Board, CS/CJ-series Serial Communications Unit, C-series C200HX/HG/HE(-Z)E Communications Board, or CQM1H Serial Communications Board**

Applicable Units:

- CS1W-SCU31-V1
- CJ1W-SCU31-V1/CJ1W-SCU41(-V1)
- CS1G-CPU42/43/44/45-E(V1)
- CS1H-CPU63/64/65/66/67-E(V1)
- CS1G-CPU42H/43H/44H/45H
- CS1H-CPU63H/64H/65H/66H/67H
- CS1D-CPU66H/67H (See note.)

- C200HE-CPU32/42-(Z)E
- C200HG-CPU33/43/53/63-(Z)E
- C200HX-CPU34/44/54/64-(Z)E
- C200HX-CPU65-ZE/85-ZE
- CQM1H-CPU51/61

**Note** A Serial Communications Board cannot be installed.

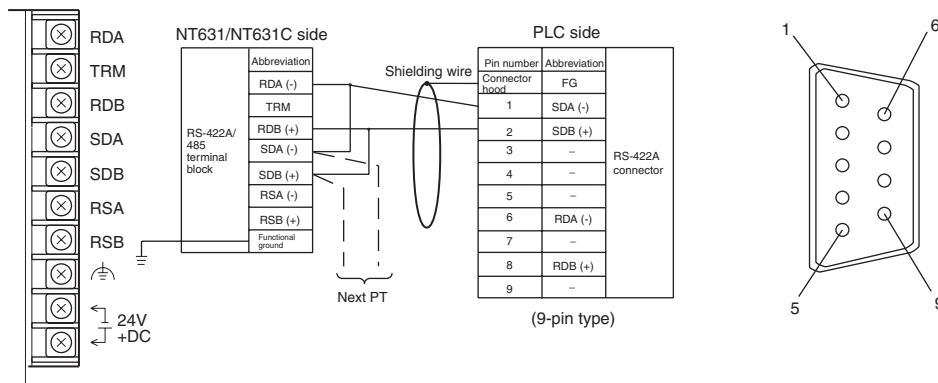

For details on handling shield wires, refer to 5-2-8 Handling the Shield on RS-422A/485 Cables on page 125.

## 5-2-6 Recommended Connectors, Cables and Crimp Terminals

### Connectors and Cables Recommended for RS-422A/485

When making an RS-422A/485 connecting cable, as far as possible use the recommended parts indicated in the table below. When using the memory link method, however, use a connector that matches with the RS-422A port at the CPU Unit (CP) side. Some Units come supplied with one connector and connector hood.

Check the required parts and prepare them in advance.

| Name           | Model       | Maker                          | Remarks  |
|----------------|-------------|--------------------------------|--|
| Connector      | XM2A-0901   | 9-pin type<br>Made by OMRON    | Delivered with the following Units:<br>CS/CJ-series CPU Units,<br>C-series C200HS<br>C200HX/HG/HE(-Z)E<br>Delivered with the following Units:<br>CVM1/CV-series CPU Units<br>CV500-LK201 |
| Connector hood | XM2S-0911   | 9-pin type<br>Made by OMRON    | Delivered with the following Units:<br>C-series C200HS<br>C200HX/HG/HE(-Z)E<br>Delivered with the following Units:<br>CVM1/CV-series CPU Units<br>CV500-LK201                            |
|                | XM2S-0911-E | 9-pin type<br>Made by OMRON    | Delivered with the following Units: CS/CJ-series PLCs  |
| Cable          | TKVVBS4P-03 | Tachii Electric Wire Co., Ltd. |  |

| Name            | Model                     | Maker                         | Remarks  |
|-----------------|---------------------------|-------------------------------|--|
| Crimp terminals | 1.25-N3A (fork type) *1   | Japan Solderless Terminal MFG | Recommended cable size: AWG22 to 18 (0.3 to 0.75 mm <sup>2</sup> ) |
|                 | Y1.25-3.5L (fork type) *1 | Molex Inc.                    |  |

\*1 Crimp terminals of common use for M3 and M3.5

The terminal screws of the NT631/NT631C are M3.5 specification. When wiring, use crimp terminals for M3.5 use. Tighten terminal screws with a tightening torque of 0.8 N·m.

The terminal screws of the RS-422A adaptor (CPM1-CIF11) are M3 specification. When wiring, use crimp terminals for M3 use. Tighten terminal screws with a tightening torque of 0.5 N·m.

- Note**
1. Make sure to tighten screws at the connectors after cable connection.
  2. Always use crimp terminals for wiring at terminal blocks.

**Examples of Applicable Terminals**

- For M3.5

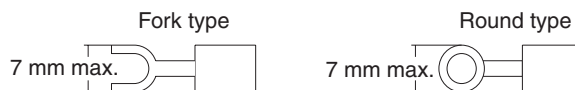

- For M3

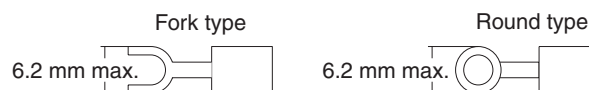

### 5-2-7 Setting the Terminal Resistance for RS-422A/485 Communications

The serial port B connector of the NT631/NT631C has a terminal resistance setting terminal (TRM).

In RS-422A/485 communications, a terminal resistor must be set at the device at the end of the communications cable, but not at any other device.

The NT631/NT631C has a built-in terminal resistor, and whether or not the terminal resistance is applied is set by shorting or opening the terminal resistance setting terminals (TRM). The terminal resistance is 120 Ω.

When carrying out RS-422A/485 communications using serial port B, short between terminals at the NT631/NT631C at the end of the RS-422A/485 cable. Leave these terminals open at NT631/NT631C PTs other than the one at the end of the cable.

When not using RS-422A/485 communications, the terminal resistance setting is ineffective.

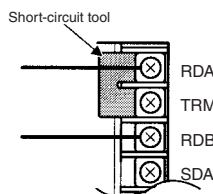

| TRM-RDA terminals | Function   |
|-------------------|--|
| Shorted           | Terminal resistance is applied.<br>Short only at the NT631/NT631C connected to the end of an RS-422A/485 cable.  |
| Open              | Terminal resistance is not applied.<br>Leave the terminals open when connecting an NT631/NT631C anywhere other than at the end of the RS-422A/485 cable. |

**Note** Before connecting or disconnecting cables between devices, make sure that the power supply to all of the connected devices (NT631/NT631C, PLC, etc.) is OFF.

**Reference:** • The internal circuit of the NT631/NT631C is shown below.

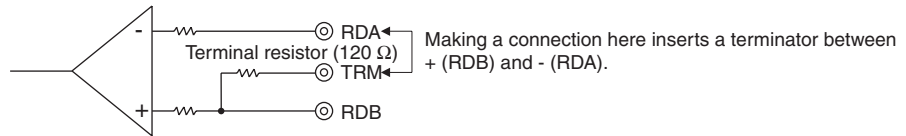

- For details on setting the terminal resistance of the host, refer to Setting methods for each type of the communications.

### 5-2-8 Handling the Shield on RS-422A/485 Cables

Perform the following procedures to connect, process the shield, and connect to ground for communications systems using the RS-422A/485. Incorrect connection may result in communications errors with the host.

#### Connecting the Ground Wire

The PT has a functional ground terminal (FG:  $\text{⏏}$ ).

- 1,2,3...**
1. Ground according to *Figure (a)* for normal grounding.
    - Connect the ground terminal (GR) of the devices to the functional ground (FG:  $\text{⏏}$ ).
    - Make sure that each signal line is grounded at only one point and ground to 100 Ω max.
    - Short the LG terminal of the PLC to the ground terminal (GR).
    - Use a wire gauge of at least 2mm<sup>2</sup> for the ground wire.
    - Refer to the manual for individual Communications Units for details on proper wiring procedures.
  2. Do not ground the functional ground (FG:  $\text{⏏}$ ) of the PT if it is mounted to the same panel as devices that generate noise, such as motors or inverters, as shown in *Figure (b)*.

#### Preparing the Shield of RS-422A/485 Connectors

Always prepare RS-422A/485 cable shields properly. Otherwise, communications errors may occur with the host.

Ground only one end of the shield when connecting the ground terminal (GR) of the devices to the functional ground (FG:  $\text{⏏}$ ), and grounding each signal line at only one point and to 100 Ω max, as shown in *Figure (a)*.

Ground both ends of the shield when not grounding the functional ground (FG:  $\text{⏏}$ ) of the PT, as shown in *Figure (b)*.

When using a CJ1M-CIF11 alone or combined with an NT-AL001, be sure to connect, process the shield, and connect to ground as shown in *Figure (b)*.

**Example of Recommended Wiring**

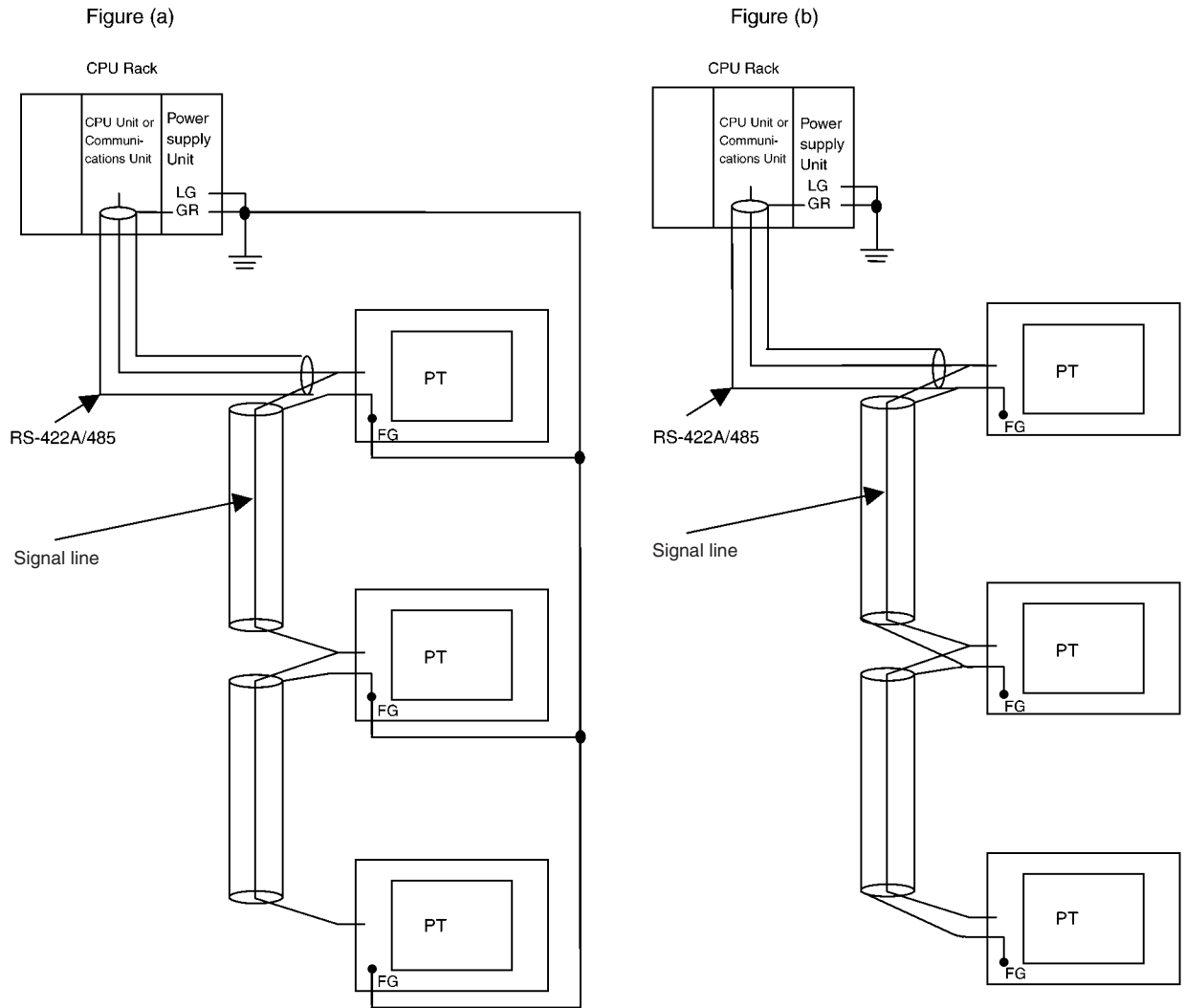



# SECTION 6

## System Menu Operation

This section describes the operation of the System Menu, focusing on the procedure to start up the NT631/NT631C.

Functions which are convenient when using the NT631/NT631C and those that are useful for system maintenance are also explained here.

|       |  |     |
|-------|--|-----|
| 6-1   | System Menu Operation Flow . . . . .   | 129 |
| 6-2   | Starting the NT631/NT631C . . . . .  | 129 |
| 6-2-1 | Operation at Startup . . . . .   | 129 |
| 6-3   | Operation Modes and the System Menu . . . . .                                      | 130 |
| 6-3-1 | Relationships among Modes . . . . .  | 130 |
| 6-3-2 | Menu Tree . . . . .  | 132 |
| 6-3-3 | Operations with the System Menu . . . . .  | 133 |
| 6-4   | Memory Initialization . . . . .  | 135 |
| 6-4-1 | Clearing Screen Data . . . . .   | 135 |
| 6-4-2 | Initializing Display History Record Data . . . . .                                 | 137 |
| 6-4-3 | Initializing Alarm History Record Data . . . . .                                   | 138 |
| 6-4-4 | Initializing the Recipe Tables . . . . .   | 140 |
| 6-4-5 | Initializing the Memory Tables . . . . .   | 141 |
| 6-4-6 | Initializing the Memory Switches . . . . .   | 143 |
| 6-5   | Operations in the System Installer Mode . . . . .                                  | 144 |
| 6-5-1 | Setting the Display Language in the System Installer Mode . . . . .                | 144 |
| 6-5-2 | Clearing/Installing the System Program . . . . .                                   | 145 |
| 6-5-3 | Changing the System Settings . . . . .   | 147 |
| 6-5-4 | Clearing Screen Data . . . . .   | 148 |
| 6-6   | Transmitting the Screen Data . . . . .   | 149 |
| 6-7   | Setting Conditions for Communications with Host by Using Memory Switches . . . . . | 152 |
| 6-7-1 | About Communications Conditions . . . . .  | 152 |
| 6-7-2 | Setting the Host Link Method . . . . .   | 155 |
| 6-7-3 | Setting the NT Link (1:1) Method . . . . .   | 157 |
| 6-7-4 | Setting the NT Link (1:N) Method (Standard/High-speed) . . . . .                   | 158 |
| 6-7-5 | Setting the Memory Link Method . . . . .   | 160 |
| 6-7-6 | Setting the Communications Type for Serial Port B . . . . .                        | 162 |
| 6-8   | Starting Operation . . . . .   | 163 |
| 6-9   | Various System Settings . . . . .  | 164 |
| 6-9-1 | Memory Switch Setting Screens . . . . .  | 164 |
| 6-9-2 | Setting the Start-up Wait Time . . . . .   | 165 |
| 6-9-3 | Setting the Key Press Sound . . . . .  | 166 |
| 6-9-4 | Setting the Buzzer Sound . . . . .   | 166 |
| 6-9-5 | Setting the Printer Controller . . . . .   | 168 |

|        |  |     |
|--------|--|-----|
| 6-9-6  | Setting the Print Method (NT631C Only) . . . . .             | 169 |
| 6-9-7  | Setting Screen Saver Movement . . . . .                      | 170 |
| 6-9-8  | Setting the Screen Saver Start-up Time . . . . .             | 173 |
| 6-9-9  | Setting the History Display Method . . . . .                 | 175 |
| 6-9-10 | Setting the Resume Function . . . . .                        | 177 |
| 6-9-11 | Setting the Automatic Reset Function . . . . .               | 179 |
| 6-9-12 | Setting the Time-out Interval . . . . .                      | 181 |
| 6-9-13 | Setting the Retry Count . . . . .                            | 182 |
| 6-10   | Setting the Bar Code Reader Input Function . . . . .         | 184 |
| 6-11   | System Maintenance . . . . .                                 | 187 |
| 6-11-1 | I/O Settings . . . . .                                       | 187 |
| 6-11-2 | Displaying/Setting the Calendar and Clock . . . . .          | 191 |
| 6-11-3 | Checking the PT Setting Status . . . . .                     | 193 |
| 6-11-4 | Displaying and Printing the Display History Record . . . . . | 194 |
| 6-11-5 | Displaying and Printing the Alarm History Record . . . . .   | 196 |
| 6-11-6 | Checking Screen Data . . . . .                               | 198 |
| 6-11-7 | Device Check . . . . .                                       | 201 |
| 6-11-8 | Checking Interfaces . . . . .                                | 209 |
| 6-12   | Programming Console Function . . . . .                       | 214 |
| 6-12-1 | Usable Systems . . . . .                                     | 215 |
| 6-12-2 | Connection Method . . . . .                                  | 216 |
| 6-12-3 | Method of Use . . . . .                                      | 217 |
| 6-13   | Device Monitor Function . . . . .                            | 220 |
| 6-13-1 | Compatible Systems . . . . .                                 | 221 |
| 6-13-2 | Connection Method . . . . .                                  | 221 |
| 6-13-3 | Method of Use . . . . .                                      | 223 |
| 6-14   | Version Display . . . . .                                    | 223 |
| 6-14-1 | Method of Use . . . . .                                      | 224 |

## 6-1 System Menu Operation Flow

Follow the procedure below when using the NT631/NT631C for the first time or changing the system program.

### Create the Screen Data



Create the data to be displayed on the NT631/NT631C by using the Support Tool.

For details on creating screen data, refer to the *NT-series Support Tool Ver. 4.□ for Windows Operation Manual (V061-E1-□)*.

### Start Up the NT631/NT631C (Display the System Menu) (page 129)



Turn ON the power to the NT631/NT631C.

If no screen data has been registered, an error message is displayed. In this case, press the OK touch switch on the error message screen to display the System Menu.

If screen data has been registered and the RUN mode is established, perform the appropriate operations on the touch panel to display the System Menu.

### Initialize the Memory (page 135)



If necessary, initialize the memory of the NT631/NT631C by operation from the System Menu.

### Transmit the Screen Data (page 149)



Connect the Support Tool to the NT631/NT631C and transmit the screen data from the Support Tool to the NT631/NT631C.

For details on connecting the Support Tool, refer to *3-2 Connecting to the Support Tool (page 35)*.

### Set the Memory Switches (pages 152, 164, 184)



Select the System Menu and set the operations of the NT631/NT631C — for example the conditions for communications with the host — using the memory switches.

### Start Operation (page 163)



Connect the NT631/NT631C to the host and start operation.

### System Maintenance (page 187)

If an error occurs during operation, check the I/Os, settings, etc., by referring to this guide.

## 6-2 Starting the NT631/NT631C

After checking that the hardware has been connected correctly, switch on the power to the NT631/NT631C to start it up.

This section describes the operation of the NT631/NT631C when it is started up.

### 6-2-1 Operation at Startup

The NT631/NT631C operates as follows when the power is switched ON, or when it is reset.

#### Initial Processing



Self diagnosis — including a check on the internal memory of the NT631/NT631C and a system program check — and the internal processing required for startup, are performed.

If an error occurs during initial processing, an error screen is displayed.

If there is an error in the system program, the system program must be re-installed. For details on the installation procedure, refer to *6-5 Operations in the System Installer Mode*.

**Memory Unit Check and Processing**



Check if a Memory Unit is installed. If a Memory Unit is installed, processing (screen data and system program reading/writing) is executed in accordance with its DIP switch settings (page 39).

If there is an error in the screen data, an error screen is displayed. Pressing the OK touch switch on the error screen will return the display to that immediately before the error occurred. It is also possible to display the System Menu from the error screen by pressing two of the four corners of the touch panel simultaneously. If there is an error in the system program, the main menu of the system installer mode is displayed. If this is the case, reinstall the proper system program.

Initialize the memory or change the settings as required.

**Start of Communications with the Host**



Communications with the host start in accordance with the communications method set in the system memory of the NT631/NT631C. During the interval until communications are established, the system initialization screen (screen No. 9000) is displayed.

For details, refer to *6-8 Starting Operation*.

If the system initialization screen remains on, display the System Menu by pressing two of the four corners of the touch panel simultaneously, and check the settings for the communications conditions for communications with the host.

**Operation Start**

The RUN mode is established, and operation starts in accordance with the screen data in the NT631/NT631C.

When changing the settings or checking the statuses, perform the appropriate operation by displaying the System Menu. For details on displaying the System Menu, refer to *6-3-3 Operations with the System Menu* (page 133).

**6-3 Operation Modes and the System Menu**

The NT631/NT631C operates in four modes: the RUN, Transmit, Maintenance, and Expansion modes. These modes are selected from the System Menu.

In addition, the NT631/NT631C also features the System Installer mode which is used specifically for installing the system program.

The System Installer mode is selected by operation at the panel when the NT631/NT631C power is switched ON.

**6-3-1 Relationships among Modes**

The relationships among the System Menu, each of the operation modes, and the System Installer mode, are indicated in the figure below.

For details on system menu operation, refer to *6-3-3 Operations with the System Menu* (page 133).

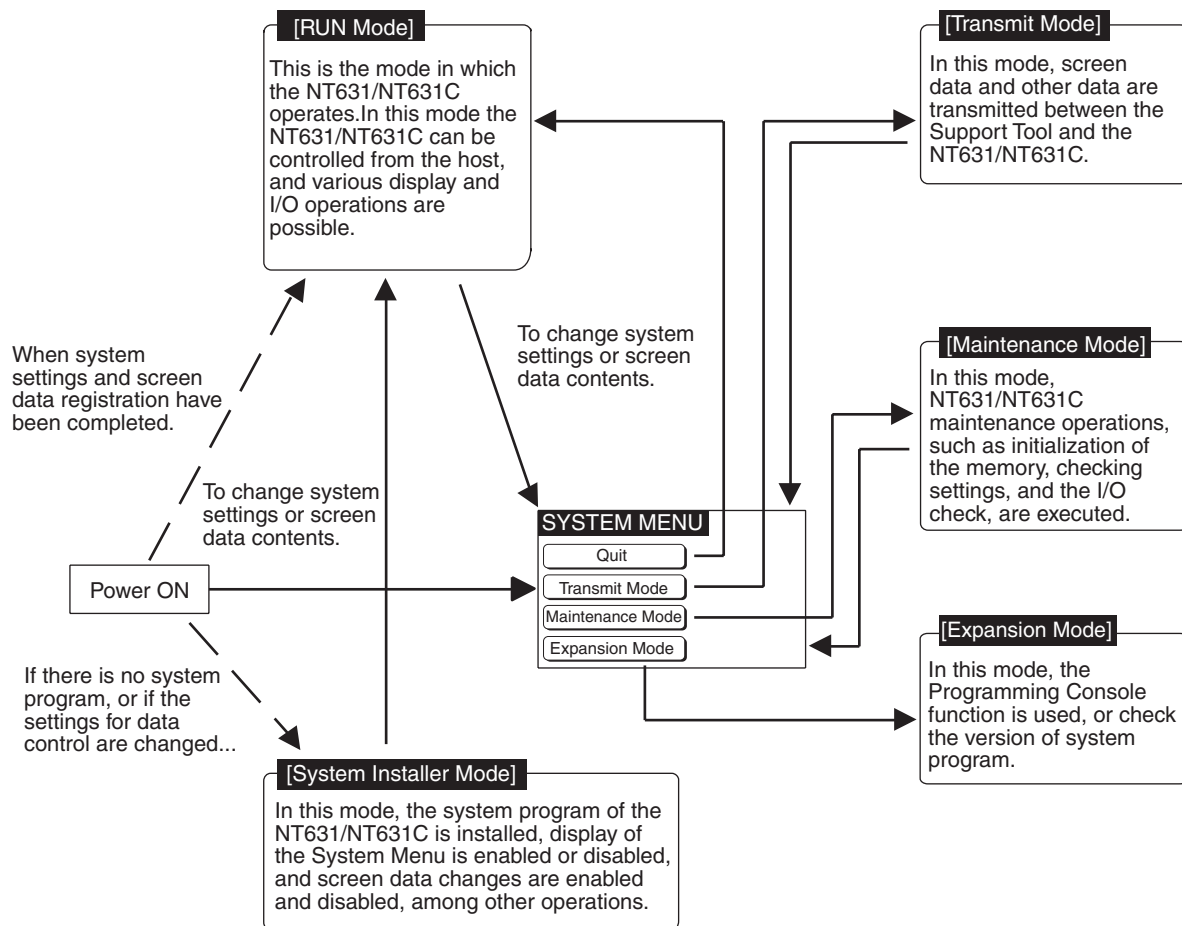

**Items in the System Menu**

The items displayed in the system menu and their functions are as follows.

| Menu Item     | Function   |
|---------------|--|
| Quit          | Clear the System Menu screen and return to the RUN mode screen.  |
| Transmit Mode | Display the Transmit Mode screen to allow transmission for screen data between the Support Tool and the NT631/NT631C. For details on transmission of screen data, refer to 6-6 <i>Transmitting the Screen Data</i> . |

| Menu Item        | Function   |
|------------------|--|
| Maintenance Mode | Display the Maintenance Mode menu to allow system maintenance of the NT631/NT631C, and various NT631/NT631C settings.  |
| Expansion Mode   | Display the Expansion Mode menu to allow selection of the expansion functions supported by the NT631/NT631C. The following expansion functions are supported: <ul style="list-style-type: none"> <li data-bbox="754 389 1442 495">• Version Display<br/>Displays the version of system program, the date it was created, and the PT model. For details, refer to 6-14 <i>Version Display</i>.</li> <li data-bbox="754 500 1442 634">• Programming Console Function<br/>Allows the NT31/NT31C to be used as a Programming Console for a CS/CJ-series PLC, CPM1, CPM2A, CPM2C, CQM1, CQM1H, C200HX/HG/HE(-Z), or SRM1. For details, refer to 6-12 <i>Programming Console Function</i>.</li> <li data-bbox="754 638 1442 825">• Device Monitor Function<br/>Allows the NT31/NT31C to change the PLC's operating mode and display/change the contents of words in a CS/CJ-series PLC, CPM1, CPM2A, CPM2C, CQM1, CQM1H, C200HX/HG/HE(-Z), or SRM1. For details, refer to 6-13 <i>Device Monitor Function</i> in this manual or 2-16 <i>Device Monitor Function</i> in the <i>Reference Manual</i>.</li> </ul> |

**Functions of the System Installer Mode**

The following functions can be executed in the System Installer mode.

- Setting the display language
- Clearing and installing system programs
- Disabling/enabling display of the System Menu.
- Disabling/enabling writing to the screen data memory
- Clearing screen data

For details on these functions, refer to 6-5 *Operations in the System Installer Mode*.

**6-3-2 Menu Tree**

The System Menu allows the various functions of the NT631/NT631C to be executed by using touch switches displayed on the touch panel. The menu tree, starting from the System Menu, is shown below.

For details on System Menu operations, refer to 6-3-3 *Operations with the System Menu* (page 133).

The menu tree may differ according to the system program installed in the NT631/NT631C. The menu tree for the system program that is installed in the NT631/NT631C on shipment is shown below.

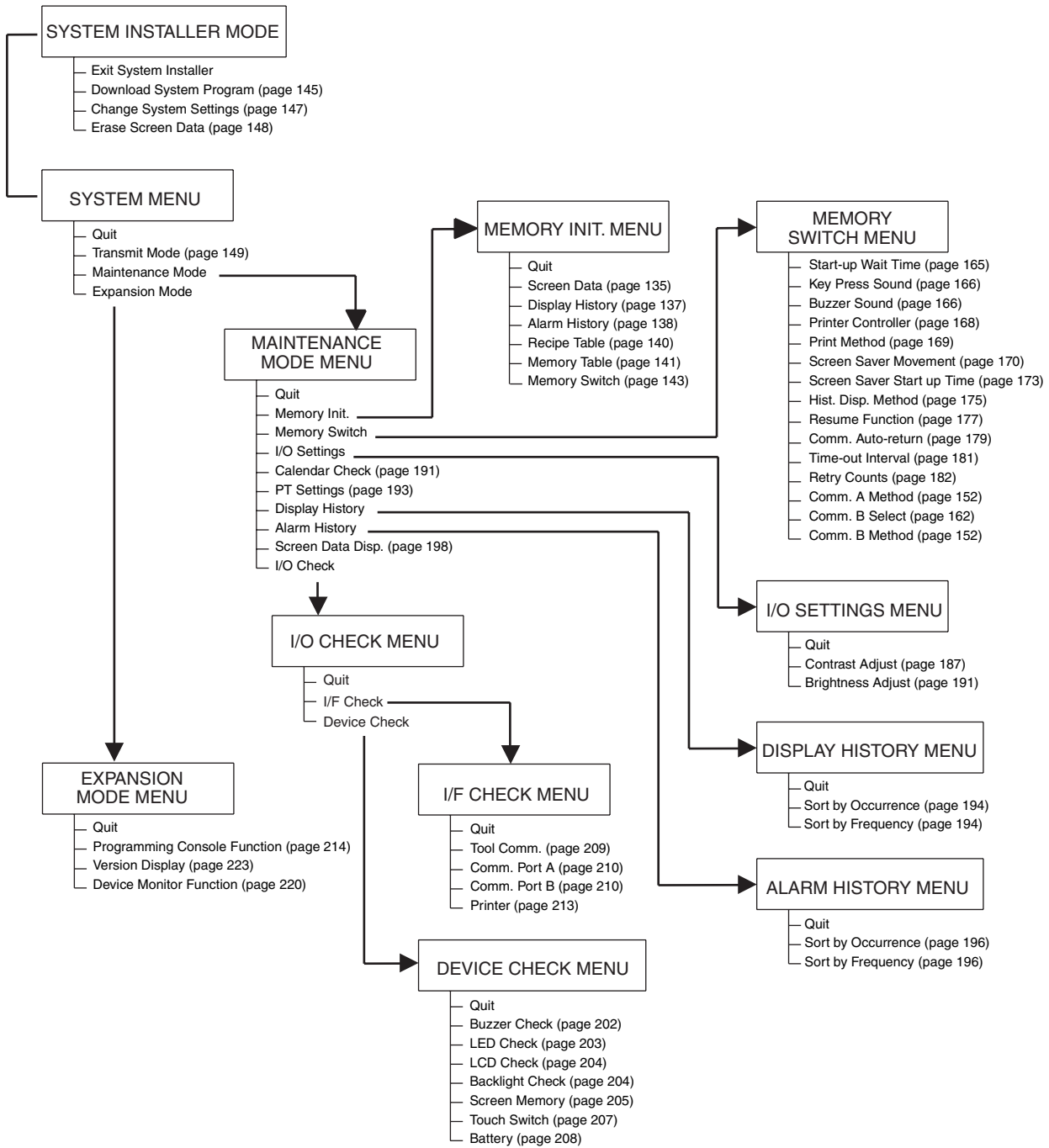

### 6-3-3 Operations with the System Menu

This section describes how to use the menus, including how to call the System Menu, how to call the System Installer mode, and how to select menu items.

#### Calling the System Menu

The System Menu can be displayed by either of the following two methods.

- Touching the corners of the touch panel
- Pressing a touch switch that displays the System Menu

#### Reference:

- If display of the System Menu is disabled by the setting made in the System Installer mode, the System Menu cannot be displayed (this does not apply if an error has occurred).

- At the same as the System Menu is displayed, the operation of the NT631/NT631C stops and the RUN LED goes OFF.

**Touching The Corners of The Touch Panel**

When two of the four corners of the touch panel (see the figure below) are touched simultaneously, the System Menu is displayed.

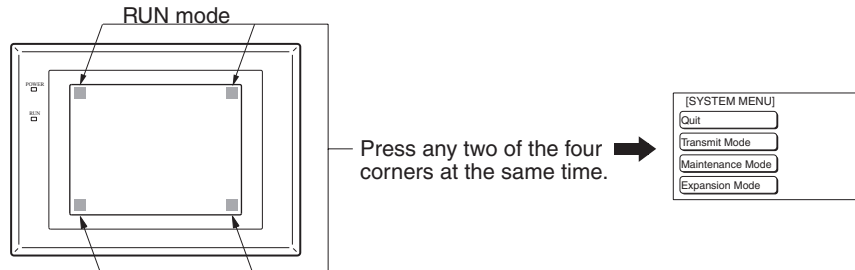

Note that the touch switches used to call the System Menu are not displayed at corners on the screen. If a touch switch displayed in a corner is pressed first, the touch switch will function and the System Menu will not be displayed. Especially, when the touch switch has switch screen function, as a result of screen switch over, it means the corner is not pressed even if it is kept pressing. To successfully call the System Menu, first press a corner where no touch switch is displayed, and then press any other corner regardless of the presence of a touch switch.

**Reference:** With the NT631/NT631C, the System Menu can be displayed even if the screen has touch switches registered at all four corners.

**Pressing a Touch Switch That Displays The System Menu**

There is a control key that has the function of displaying the System Menu. By registering the touch switch for System Menu display ([MENU]) on a screen when creating it, the System Menu can be displayed just by pressing this switch.

**Calling the System Installer Mode**

If the NT631/NT631C has no system program installed, or if the system program is destroyed, the System Installer mode is automatically established when the power is switched ON.

To establish the System Installer mode in order to install a system program or make settings for data management, either turn the power ON, or reset the NT631/NT631C, while pressing the touch switch at the top left corner of the touch panel (size: 7.2 mm × 7.2 mm).

Switch the power to the NT631/NT631C ON while pressing this touch switch.

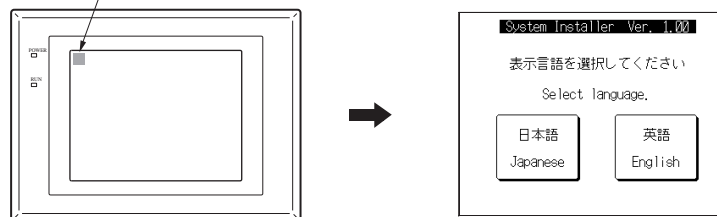

**Selecting Menu Items**

The menu items in the System Menu are displayed on the NT631/NT631C screen as touch switches. Menu items can be selected simply by pressing them.



**Example:**

Displaying the MAINTENANCE MODE MENU screen by pressing Maintenance Mode in the System Menu.

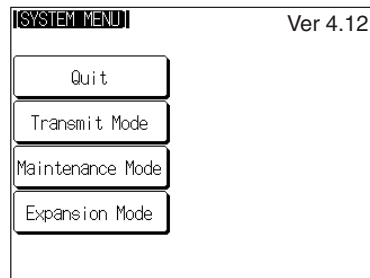

Press Maintenance Mode.

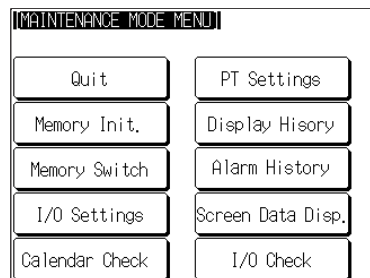

**Switching from the System Menu to the RUN Mode**

Return to the RUN mode by selecting Quit in the System Menu and other menus.

**Reference:** Unlike previous PT models, the NT631/NT631C does not return to the RUN mode automatically if no operations are performed.

## 6-4 Memory Initialization

The NT631/NT631C has the following initialization functions. Use them as necessary.

- Clearing screen data page 135
- Initializing memory tables page 141
- Initializing memory switches page 143
- Initializing display history record data page 137
- Initializing alarm history record data page 138
- Initializing recipe tables page 140

**Reference:** If writing to the screen data memory has been disabled by the System Setting setting in the System Installer mode, memory initialization is not possible.

### 6-4-1 Clearing Screen Data

Use this function if the screen data has been corrupted and the NT631/NT631C cannot be started up correctly.

This operation clears (initializes) only the screen data and contents of the calculation tables. The memory switch settings and display history/alarm history record data are retained.

**Reference:**

- When this function is used, all of the screen data contents registered in the NT631/NT631C up to that point are cleared. Check that the created screens are backed up at the Support Tool before using it.
- The screen data can be cleared in the System Installer mode too (page 148).
- The following types of data can be initialized individually.
  - Contents of numeral/character string memory tables (page 141)
  - Memory switch settings (page 143)
  - Display history record data (page 137)
  - Alarm history record data (page 138)

Clear the screen data by following the menu operation from the System Menu shown below.

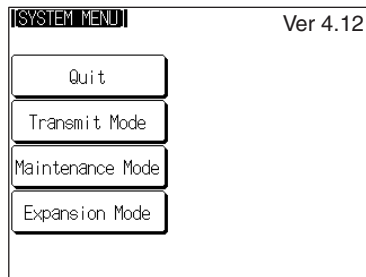

Select Maintenance Mode.

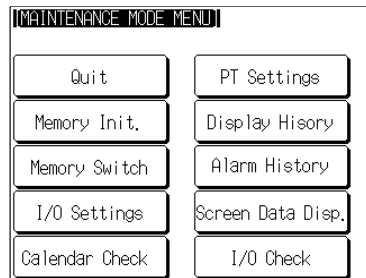

Select Memory Init..

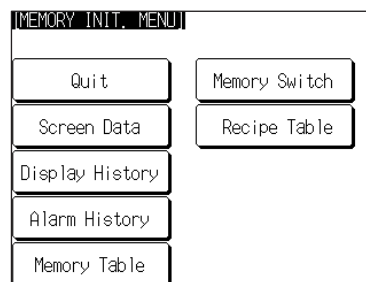

Select Screen Data.

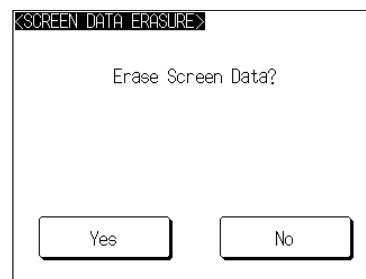

Select Yes.  
The screen data is cleared. During clearance, the message Erasing Now... is displayed.

If No is selected, the NT631/NT631C returns to the MEMORY INIT. MENU screen without clearing the screen data.

On completion of screen data clearance, the NT631/NT631C returns to the MEMORY INIT. MENU screen.

After the screen data has been cleared, if an attempt is made to set the NT631/NT631C to the RUN mode before screen data has been transmitted from the Support Tool or Memory Unit, an error message will be displayed and the RUN mode will not be established.

## 6-4-2 Initializing Display History Record Data

The display history record function keeps a record of the order of display of the screens displayed during operation, and the number of times each screen is displayed. These records are kept only for screens for which the History attribute has been set.

The maximum number of records is 1024 for sort by occurrence (order of display occurrence) and 255 for sort by frequency (order of the number of times each screen has been displayed).

Use the display history record initialization function to clear the history record data to 0, for example when the screen data has been changed, etc. Also, if Alarm (Use Ring Buffer) under History Setting of System in PT Configuration (Tools) has not been checked, no more records will be stored after the maximum number of records has been kept, and therefore the records must be periodically initialized. If Alarm (Use Ring Buffer) is checked, when the maximum number of records is reached the oldest record is deleted and the newest data is recorded.

**Reference:** The NT631/NT631C also allows the display history record data to be initialized by controlling the PT status control area from the host. For details, refer to *2-2-1 PT Status Control Area* in the *Reference Manual*.

Initialize the display history record data by following the menu operation from the System Menu shown below.

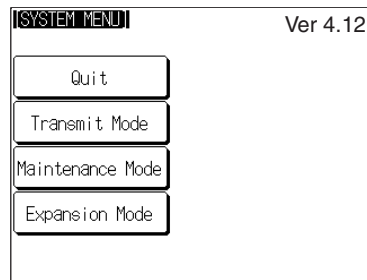

Select Maintenance Mode.

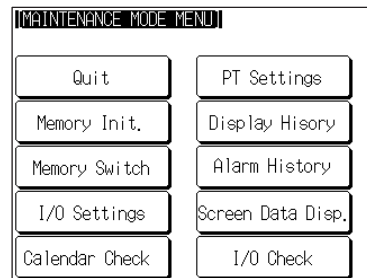

Select Memory Init..

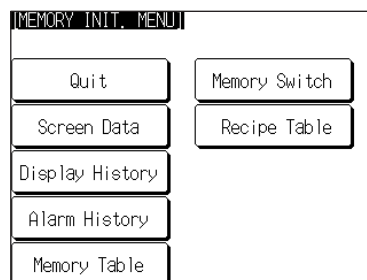

Select Display History.



Select Yes.

The display history record data is initialized. During initialization, the message Initializing is displayed.

If No is selected, the NT631/NT631C returns to the MEMORY INIT. MENU screen without initializing the display history record data.

On completion of display history record data initialization, the message Finished is displayed and the NT631/NT631C returns to the MEMORY INIT. MENU screen.

### 6-4-3 Initializing Alarm History Record Data

The alarm history record function continually checks the status of host bits that have been designated in advance with a bit memory table, and records the time when any of the bits is set to 1 (comes ON), and the number of times that each bit comes ON.

The maximum number of records is 256 for sort by occurrence (order of error occurrence) and 255 for sort by frequency (order of the number of times each error has occurred).

Use the alarm history record initialization function to reset the alarm history record data to 0, for example when the screen data has been changed, etc. Also, if Screen (Use Ring Buffer) under History Setting in the PT Environment Settings – System Settings has not been checked, no more records will be stored after the maximum number of records has been kept, and therefore the records must be periodically initialized. If Screen (Use Ring Buffer) is checked, when the maximum number of records is reached the oldest record is deleted and the newest data is recorded.

**Reference:** The NT631/NT631C also allows the alarm history record data to be initialized by controlling the PT status control area from the host. For details, refer to 2-2-1 *PT Status Control Area* in the *Reference Manual*.

Initialize the alarm history record data by following the menu operation from the System Menu shown below.

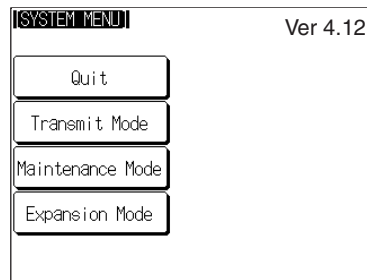

Select Maintenance Mode.

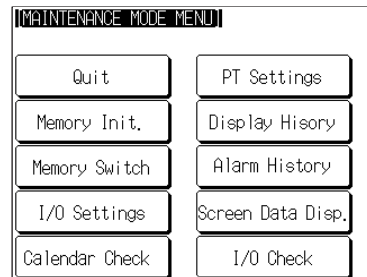

Select Memory Init..

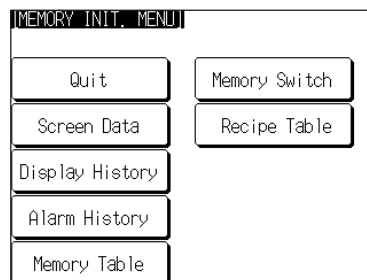

Select Alarm History.

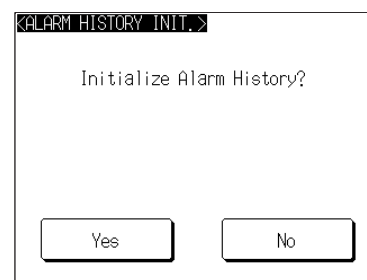

Select Yes.

The alarm history record data is initialized. During initialization, the message Initializing is displayed.

If No is selected, the NT631/NT631C returns to the MEMORY INIT. MENU screen without initializing the alarm history record data.

On completion of alarm history record data initialization, the message Finished is displayed and the NT631/NT631C returns to the MEMORY INIT. MENU screen.

#### 6-4-4 Initializing the Recipe Tables

You can initialize the recipe tables (i.e., all the recipe data) edited in the NT631/NT631C. Here, "initializing" the recipe tables means to restore the battery backup memory ("recipe data memory") to the values in flash memory at that time. If, after downloading from the Support Tool, you do not upload the data even once, initialization will restore the initial values set using the Support Tool. The values will not be cleared.

Initialize the recipe tables by following the menu operation from the System Menu shown below.

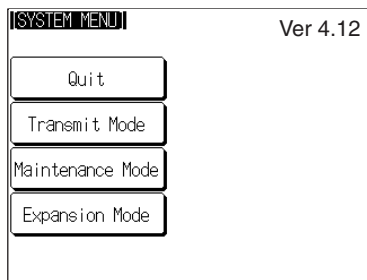

Select Maintenance Mode.

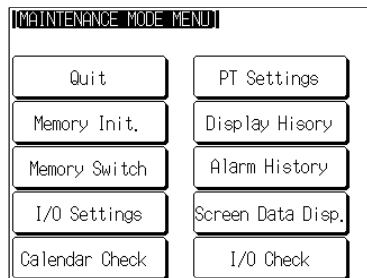

Select Memory Init..

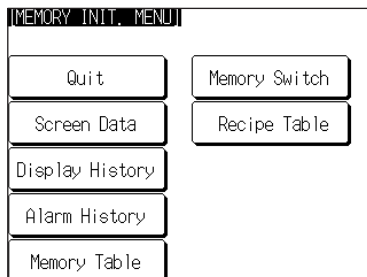

Select Recipe Table.

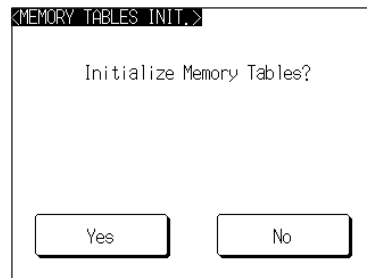

Select Yes.

The recipe tables are initialized. During initialization, the message Initializing is displayed.

If No is selected, the NT31/NT31C returns to the MEMORY INIT. MENU screen without initializing the recipe tables.

On completion of memory table initialization, the message Finished is displayed and the NT31/NT31C returns to the MEMORY INIT. MENU screen.

### 6-4-5 Initializing the Memory Tables

It is possible to initialize the numeral memory tables and character string memory tables in the NT631/NT631C.

When these tables are initialized, the values are returned to those set by the Support Tool (they are not cleared).

When the memory tables are initialized, they are returned to their initial values regardless of the setting made for the resume function (page 177).

If ON is set for the Resume Function memory switch, the initial values set with the Support Tool will not be recorded in the memory tables unless they are initialized.

- Reference:**
- If OFF is set for the Resume Function memory switch, the memory tables can be initialized just by switching the NT631/NT631C power off and back on again, or by resetting the NT631/NT631C (page 177).
  - The bit memory table merely reflects the statuses of bits at the host and therefore cannot be initialized.

Initialize the memory tables by following the menu operation from the System Menu shown below.

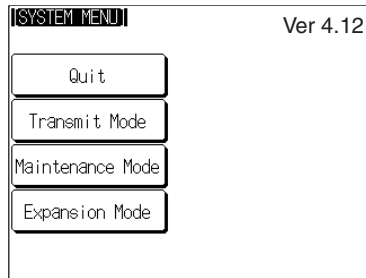

Select Maintenance Mode.

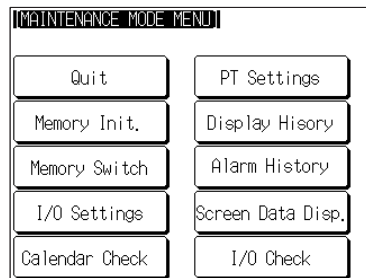

Select Memory Init..

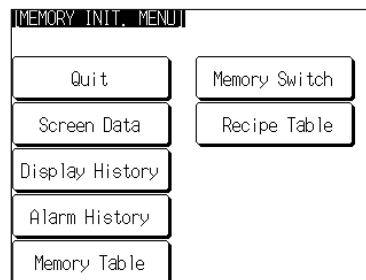

Select Memory Table.

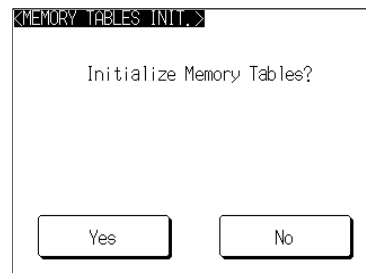

Select Yes.  
The memory tables are initialized. During initialization, the message Initializing is displayed.



If No is selected, the NT631/NT631C returns to the MEMORY INIT. MENU screen without initializing the memory tables.

On completion of memory table initialization, the message Finished is displayed and the NT631/NT631C returns to the MEMORY INIT. MENU screen.

### 6-4-6 Initializing the Memory Switches

Initialization returns all the memory switches of the NT631/NT631C to their status on shipment.

Initialize the memory switches by following the menu operation from the System Menu shown below.

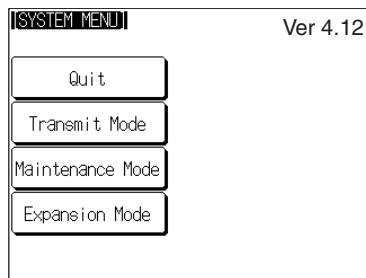

Select Maintenance Mode.

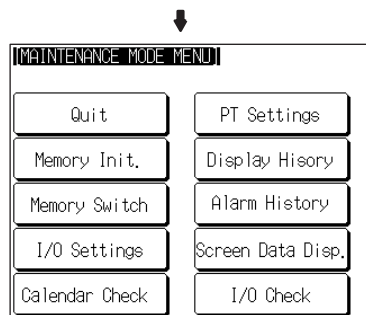

Select Memory Init..

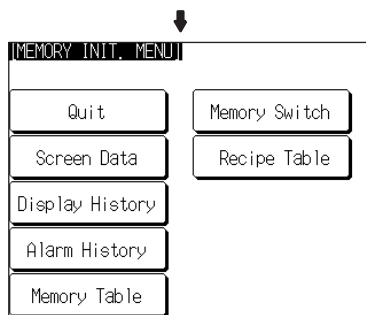

Select Memory Switch.

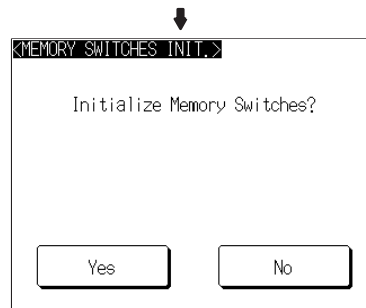

Select Yes.

The memory tables are initialized. During initialization, the message Initializing is displayed.

If No is selected, the NT631/NT631C returns to the MEMORY INIT. MENU screen without initializing the memory switches.

On completion of memory switch initialization, the message Finished is displayed and the NT631/NT631C returns to the MEMORY INIT. MENU screen.

After initialization, the memory switch statuses are as follows.

| Memory Switch              | Status                                       |
|----------------------------|--|
| Start-up Wait Time         | 00   |
| Key Press Sound            | ON   |
| Buzzer Sound               | OFF  |
| Printer Controller         | ESC/P  |
| Print Method               | Tone (NT631C only)                           |
| Screen Saver Movement      | Display erased                               |
| Screen Saver Start up Time | 010  |
| Hist. Disp. Method         | From New Data                                |
| Resume Function            | OFF  |
| Comm. Auto-return          | OFF  |
| Time-out Interval          | 01   |
| Retry Counts               | 005  |
| Comm. A Method             | Host Link (communications speed = 9600 bps)* |
| Comm. B Select             | RS-232C                                      |
| Comm. B Method             | None   |

\* The communications conditions for a bar code reader are initialized as follows:

Data bits: 7 bits; stop bit: 1 bit; parity: none; flow control: RS/CS.

## 6-5 Operations in the System Installer Mode

The following functions can be executed in the System Installer mode:

- Setting the display language (see below)
- Clearing/installing the system program (page 145)
- Disabling/enabling display of the System Menu (changing the system settings) (page 147)
- Disabling/enabling writing to the screen data memory (changing the system settings) (page 147)
- Clearing screen data (page 148)

For details on calling the System Installer mode, refer to Calling the System Installer Mode (page 134).

The version code displayed beside the System Installer title on the screen indicates the version of the System Installer Mode. For details, refer to 3-5 Using a Memory Unit.

### 6-5-1 Setting the Display Language in the System Installer Mode

The first setting made in the System Installer mode is to select whether the display language is to be English or Japanese.



Select English or Japanese.

From here on, this manual assumes that English has been selected here.

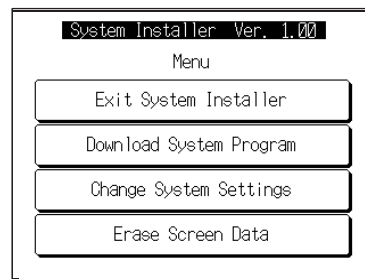

The System Installer mode menu is displayed.

If there is no system program or the system program has been corrupted, the message System Program not exist or incorrect. is displayed at the bottom of the screen.

## 6-5-2 Clearing/Installing the System Program

Use this function when the system program of the NT631/NT631C has been corrupted, or when installing a new system program.

### Reference:

- In order to install a system program, the system installer must also be installed at the Support Tool. The system installer is an accessory with the Support Tool (NT-ZJCAT1-EV4). When installing the Support Tool in a personal computer, install the system installer also. For details on the method for installing the system installer at the Support Tool side, and the operating procedure, refer to the *NT-series Support Tool Ver. 4.□ for Windows Operation Manual (V061-E1-□)*.
- When the system program is cleared by mistake, it becomes impossible to use the NT631/NT631C at all. Check that the system installer is installed at the Support Tool side before deleting the program. However, note that the registered screen data and memory switch settings are retained.
- It becomes possible to install the system program inside the Memory Unit automatically by installing the Memory Unit at startup (Refer to 3-5 *Using a Memory Unit*).

Clear/install the system program by following the menu operation from the System Installer mode menu shown below.

**Clearing the System Program**



Select Download System Program.



Select Yes.

The system program is cleared. During clearance, the message Erasing ... is displayed.

- If Return to Menu is selected, the NT631/NT631C returns to the System Installer mode menu without clearing the system program.
- If clearance fails, a screen asking whether you wish to try again is displayed.

On completion of system program clearance, the NT631/NT631C enters the standby status for downloading of the system program.

**Downloading the System Program**

On normal completion of system program clearance, the standby status for system program downloading is automatically established.



When the NT631/NT631C enters this status, transmit the system program from the system installer at the personal computer. During downloading, the progress of transmission is indicated on the screen.

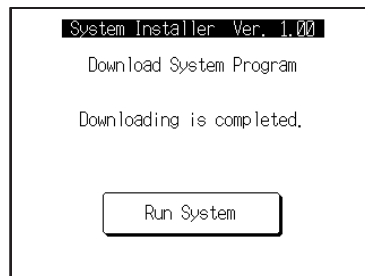

Select Run System.

If Abort is selected during standby for downloading or during downloading, a screen asking whether you wish to download again is displayed.

When the system program is started, the NT631/NT631C starts up normally. If no screen data has been registered, an error message will be displayed indicating that screen data hasn't been registered. Transfer the screen data and proceed.

**Reference:** If the new system program is not downloaded successfully after deleting a system program, it is not possible to use the NT631/NT631C at all. After deleting the system program, be sure to download a new one.

### 6-5-3 Changing the System Settings

The NT631/NT631C allows the following settings to be made to prevent the screen data and memory switch settings from being changed or deleted by operating errors.

#### **Disabling/enabling System Menu Display**

When System Menu display is disabled by this setting, the System Menu cannot be displayed by touch panel operations or by using the touch switches. However, if a error occurs, the System Menu can be displayed from the error message screen.

#### **Disabling/enabling Writing to The Screen Data Memory**

When writing to the screen data memory is disabled by this setting, it is impossible to use the following System Menu functions.

- Switching to the Transmit mode
- Displaying the memory switch setting screens
- Checking the screen data memory
- Displaying the initialization menu
- Displaying the calendar/time setting screen (the calendar/time display screen can be displayed)

Change the system settings by following the menu operation from the System Installer mode menu shown below.

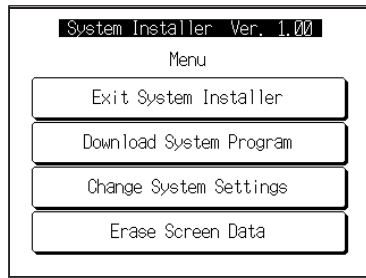

Select Change System Settings.

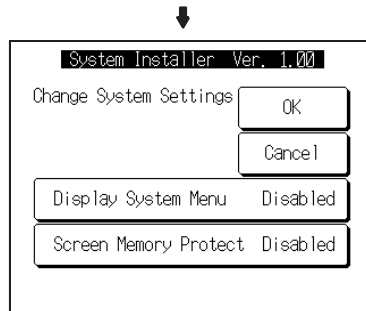

Select Display System Menu or Screen Memory Protect.

Each time either of these items is selected, the setting switches from Disabled to Enabled or vice versa.

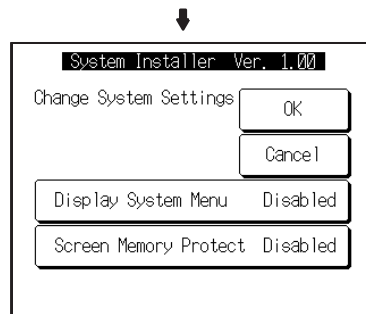

Select OK.

The settings are written to the NT631/NT631C while the screen is displayed.

- If Cancel is selected, the NT631/NT631C returns to the System Installer mode menu without changing the settings. The settings remain as they were before the operation was started.
- If writing of the settings fails, a screen asking whether you wish to try again is displayed.

After the settings have been written, the System Installer mode menu screen is redisplayed.

### 6-5-4 Clearing Screen Data

If the screen data has been corrupted and the NT631/NT631C cannot be started normally, use this function to clear the screen data.

Note that only the screen data is cleared (initialized), and the memory switch settings and the display history/alarm history record data are retained.

**Reference:**

- When this function is used, all of the screen data contents registered in the NT631/NT631C up to that point are cleared. Check that the created screens are backed up at the Support Tool before using it.
- The screen data can also be cleared from the System Menu (page 135).

- If the screen data is cleared in the System Installer mode, the message Screen Data Corrupted may be displayed on switching to the RUN mode. If this happens, initialize the screen data again from the MEMORY INIT. MENU screen.

Clear the screen data by following the menu operation from the System Installer mode menu shown below.

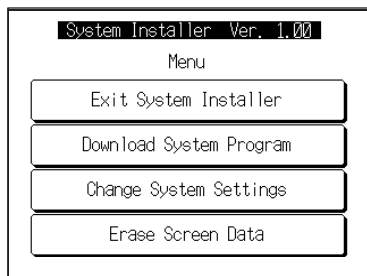

Select Erase Screen Data.

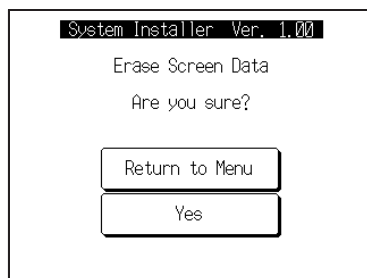

Select Yes.

The screen data is cleared. During clearance, the message Erasing ... is displayed.

- If Return to Menu is selected, the NT631/NT631C returns to the MEMORY INIT. MENU screen without clearing the screen data.
- If screen data clearance fails, a screen asking if you wish to try again is displayed.

On completion of screen data clearance, the NT631/NT631C returns to the System Installer mode menu screen.

After the screen data has been cleared, if an attempt is made to set the NT631/NT631C to the RUN mode before screen data has been transmitted from the Support Tool or Memory Unit, an error message will be displayed and the RUN mode will not be established.

## 6-6 Transmitting the Screen Data

The screen data is created with the Support Tool and then transmitted to the NT631/NT631C. This section explains how to transmit the screen data.

For details on how to create the screen data and the operation of the Support Tool, refer to the *Reference Manual* and the *NT-series Support Tool Ver. 4.□ for Windows Operation Manual (V061-E1-□)*.

**Reference:**

- The screen data can be transmitted also from the Memory Unit installed in the NT631/NT631C. For details on this method, refer to *3-5 Using a Memory Unit*.
- The screen data can be transmitted at a faster rate by setting High for Baud Rate on the Comms. Setting... window of the Support Tool.

- If writing to the screen data memory is disabled by the setting made for System Setting in the System Installer mode, screen data transmission is not possible.

### Screen Data Composition and Transmission Units

The screen data comprises the following types of data.

- User screen data (screen units)
- System memory (memory switch) settings
- Direct connection information
- Numeral memory table data
- Character string memory table data
- Bit memory table data
- Mathematical table data
- Mark information
- Image/library data
- Recipe table data

It is possible to transmit the screen data (data for all the screens) in file units, or to transmit individual data or the data of individual screens in data units. (It is not possible to transmit table data in data units.)

When data is transmitted in file units, all of the screen data in the NT631/NT631C is cleared and then the new data is transmitted.

When data is transmitted in data units, first the previous data is invalidated, then the new data is registered as valid data. Since the previous data is not cleared, free memory area in the NT631/NT631C will be insufficient when transmissions in data units are repeated. If this happens, write the screen data again by data transmission in file units.

### Transmitting Screen Data from the Support Tool

To transmit screen data from the Support Tool to the NT631/NT631C, follow the procedure below.

#### Operation

**1,2,3...**

1. Connect the NT631/NT631C to a personal computer in which the Support Tool has been installed and turn the power to the NT631/NT631C ON.
2. Turn ON the power to the personal computer and start up the Support Tool.
3. Establish the Transmit mode by following the menu operation from the System Menu shown below at the NT631/NT631C.



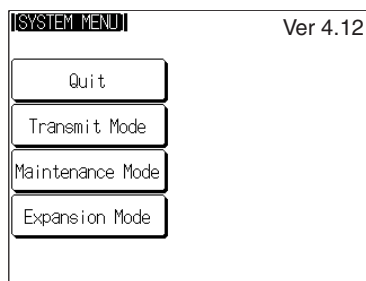

Select Transmit Mode.

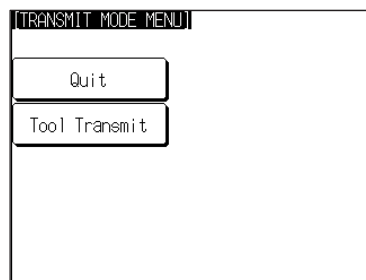

Select Tool Transmit.

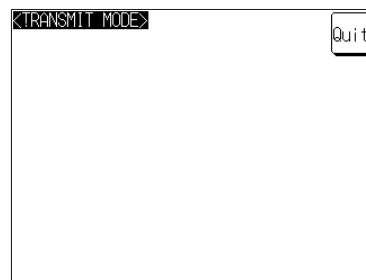

4. Open the screen data to be transmitted at the Support Tool, then select Download (NTST PT) in the Support Tool's Connect menu and specify the data to be transmitted.
5. During screen data transmission, the transmission status is displayed.
6. On completion of screen data transmission, press the Quit touch switch. The NT631/NT631C returns to the Transmit mode.

If the screen data cannot be successfully transmitted from the Support Tool, use the communications check functions of the NT631/NT631C to check if communications between the NT631/NT631C is normal or not (page 209).

**Precautions to Be Observed When Transmitting Screen Data**

If any of the following, or a system error, occurs during transmission of screen data, the transmitted screen data will not be registered correctly in the NT631/NT631C. If this happens, the NT631/NT631C may not enter the RUN mode when started up, or there may be unpredictable malfunctions such as failure to display screens during operation. In this case, the screen data must be retransmitted in file units to register it correctly.

- The power to the NT631/NT631C is interrupted or the NT631/NT631C is reset.
- The power to the personal computer on which the Support Tool is running is interrupted or the computer is reset.
- The cable connecting the NT631/NT631C to the personal computer on which the Support Tool is running is disconnected or has a broken wire.
- The Quit touch switch on the NT631/NT631C screen is pressed to end screen data transmission.

- Screen data transmission is stopped by operation at the Support Tool.

**Note** When transferring the data in units of screens, if there are changes in memory table and/or direct access, transfer such data along with the screen data.

## 6-7 Setting Conditions for Communications with Host by Using Memory Switches

The NT631/NT631C can be connected to the host by the following 7 types of communications methods can be used to communicate with a host.

- Host link
- NT Link (1:1)
- NT Link (1:N)
- High-speed NT Link (1:N)
- Memory link method
- Mitsubishi A-computer link method
- Mitsubishi FX method

The NT631/NT631C has the following two ports, either of which can be used for communications with the host, depending on the requirements.

- Serial port A (exclusively for RS-232C, 9-pin connector)
- Serial port B (RS-232C/RS-422A (selectable), 25-pin connector)

The method for setting the communications method for communications with the host is described here.

For details on setting the communications conditions for a bar code reader, refer to *6-10 Setting the Bar Code Reader Input Function*.

**Reference:**

- Apart from the host, it is also possible to connect the Support Tool or a bar code reader to serial port A. When a bar code reader is connected at serial port A, the host must be connected at serial port B. When serial port A is being used for communications with the host, the host must be disconnected so that the Support Tool can be connected.
- There are four memory switch setting screens. The conditions for communications with the host are set on the fourth screen (the screen on which 4/4 is displayed). For details on setting memory switches other than those for setting the conditions for communications with the host, refer to *6-9 Various System Settings*.
- When using the Mitsubishi A-computer link method and Mitsubishi FX method, a system program for multi-vendors is required. Install the system program to the NT631/631C by the system installer (refer to page 145). For details, refer to *PLC Connection Manual (V042-E1-□)*.
- When using PLCs manufactured by Allen-Bradley, GE Fanuc, or Siemens, refer to *NT31/631 Multi Vendor Connection Manual (V060-E1-□)*.

### 6-7-1 About Communications Conditions

**Items Set for Communications Conditions**

The following settings are made for the communications conditions for communications between the NT631/NT631C and the host.

**Port Communications Method/Communications Type Settings**

| Setting Item   | Function   | Setting Options   | Page                            |
|----------------|--|---|---------------------------------|
| Comm. A Method | Set the communications method used at serial port A. Depending on the communications method, further communications condition settings may be necessary. | A system program for OMRON model.<br>None/Host Link/NT Link (1:1)/<br>NT Link (1:N) (standard or high-speed)/Bar-Code Reader<br>Memory link | 155<br>157<br>158<br>184<br>160 |
| Comm. B Select | Set whether serial port B is to be used for RS-232C or RS-422A communications.   | RS-232C/RS-422A   | 162                             |
| Comm. B Method | Set the communications method used at serial port B. Depending on the communications method, further communications condition settings may be necessary. | A system program for OMRON model.<br>None/Host Link/NT Link (1:1)/<br>NT Link (1:N) (standard or high-speed)<br>Memory link                 | 155<br>157<br>158<br>160        |

**Communications Condition Settings for The Host Link Method**

| Setting Item                        | Function  | Setting Options        | Page |
|-------------------------------------|---|------------------------|------|
| Comm. Speed<br>(for host link only) | Sets the communications speed for communications with the host. | 9600 bps/<br>19200 bps | 155  |

**Communications Condition Settings for The NT Link (1:1) Method**

No further communications conditions need to be set.

**Communications Conditions Settings for The NT Link (1:N) Method**

| Setting Item                         | Function  | Setting Options        | Page |
|--------------------------------------|---|------------------------|------|
| Unit No.<br>(for NT Link (1:N) only) | Set the unit number of the NT631/NT631C.                        | 0 to 7                 | 158  |
| Comm. Speed                          | Sets the communications speed for communications with the host. | Standard or high-speed |      |

**Setting The Conditions for Communications with The Memory Link Method**

| Setting Item | Function   | Setting Options                          | Page |
|--------------|--|--|------|
| Data bits    | Set the data bits length.  | 7, 8 bits                                | 160  |
| Stop bits    | Set the stop bits length.  | 1, 2 bits                                |      |
| Parity       | Set the parity.  | None, even, odd                          |      |
| Comm. Speed  | Set the communications speed for communications with the host.                               | 1200, 2400, 4800, 9600, 19200, 38400 bps |      |
| Flow control | Set the flow control and its method.   | None, RS/CS, XON/XOFF                    |      |
| Response     | Set whether the response is carried out for normal process of communications command or not. | Yes, No                                  |      |

**Possible Combinations of Communications Method Settings**

The combinations of communications methods that can be set with the NT631/NT631C are indicated in the table below. Combinations other than these listed below cannot be set (when using a system for multi-venders, refer to the *PLC Connection Manual (V042-E1-□)* or *NT31/631 Multi Vendor Connection Manual (V060-E1-□)*).

| Serial port B | Serial port A |           |               |               |                 |             |
|---------------|---------------|-----------|---------------|---------------|-----------------|-------------|
|               | None          | Host Link | NT Link (1:1) | NT Link (1:N) | Bar-code reader | Memory Link |
| None          | ○             | ○         | ○             | ○             | ○               | ○           |
| Host Link     | ○             | ×         | ×             | ×             | ○               | ×           |
| NT Link (1:1) | ○             | ×         | ×             | ×             | ○               | ×           |
| NT Link (1:N) | ○             | ×         | ×             | ×             | ○               | ×           |
| Memory Link   | ○             | ×         | ×             | ×             | ○               | ×           |

- : Possible combination
- ×: Impossible combination

Combinations other than those indicated above cannot be set.

**Reference:** When using serial port B for communications with the host, and serial port A for the transmission of screen data from the Support Tool, set the settings of serial port A to None.

### 6-7-2 Setting the Host Link Method

Set the communications conditions for the host link method at serial port A or serial port B by following the operation from the System Menu shown below.

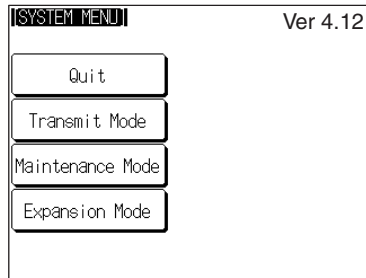

Select Maintenance Mode.

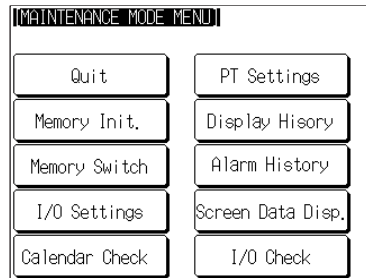

Select Memory Switch.

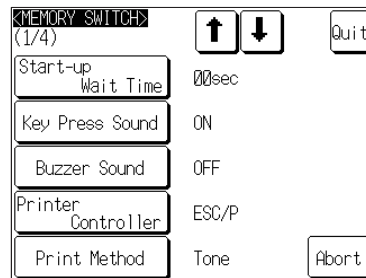

Display the fourth memory switch screen by pressing the [↓] (next screen) or [↑] (previous screen) touch switch.

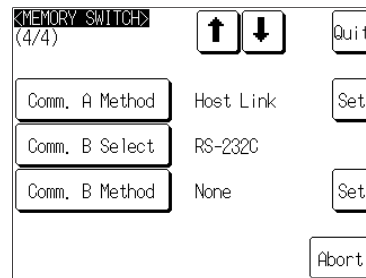

Press the touch switch corresponding to the port at which the host link method is to be set (Comm. A Method or Comm. B Method) to display the setting option Host Link.

The setting option changes each time the touch switch is pressed.

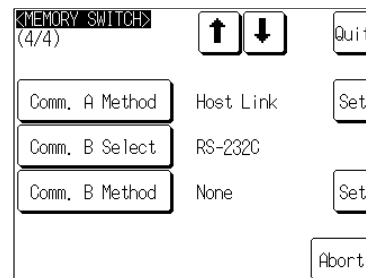

Press the Set touch switch to the right of the port at which the setting has been made.

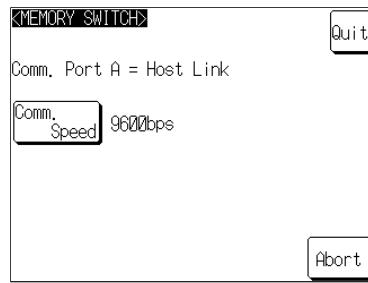

Press the Comm. Speed touch switch to display the communications speed to be set.

The setting option changes each time the touch switch is pressed.

In this example, serial port A is used.

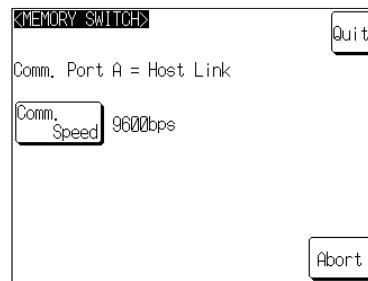

Press Quit.

The communications speed is set.

- To quit the communications speed setting screen without setting the communications speed, press the Abort touch switch. The NT631/NT631C returns to the memory switch setting screen (4/4) and the previous communications speed remains in effect.

On completion of communications speed setting, the NT631/NT631C returns to the memory switch setting screen (4/4).

To set other memory switches, select the relevant screen using the [↓] (next screen) or [↑] (previous screen) touch switch, then make the setting.

- To confirm the settings and quit the memory switch setting screen, press the Quit touch switch. The settings made last will be set and the NT631/NT631C will return to the MAINTENANCE MODE MENU screen.
- To quit the memory switch setting screen without confirming the settings, press the Abort touch switch. The NT631/NT631C will return to the MAINTENANCE MODE MENU screen with the previous settings still in effect.

### 6-7-3 Setting the NT Link (1:1) Method

Set the communications conditions for the NT Link (1:1) method at serial port A or serial port B by following the operation from the System Menu shown below.

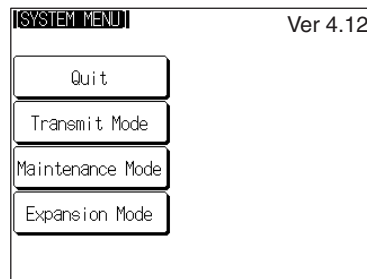

Select Maintenance Mode.

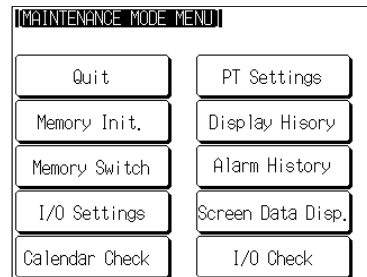

Select Memory Switch.

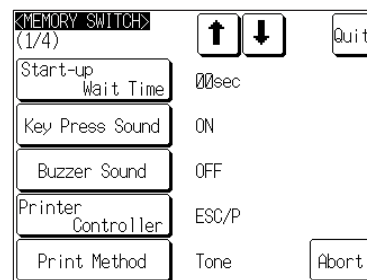

Display the fourth memory switch screen by pressing the [↓] (next screen) or [↑] (previous screen) touch switch.

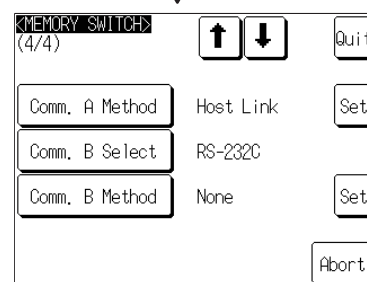

Press the touch switch corresponding to the port at which the NT Link (1:1) method is to be set (Comm. A Method or Comm. B Method) to display the setting option NT Link (1:1).

The setting option changes each time the touch switch is pressed.

To set other memory switches, select the relevant screen using the [↓] (next screen) or [↑] (previous screen) touch switch, then make the setting.

- To confirm the settings and quit the memory switch setting screen, press the Quit touch switch. The settings made last will be set and the NT631/NT631C will return to the MAINTENANCE MODE MENU screen.
- To quit the memory switch setting screen without confirming the settings, press the Abort touch switch. The NT631/NT631C will return to the MAINTENANCE MODE MENU screen with the previous settings still in effect.

### 6-7-4 Setting the NT Link (1:N) Method (Standard/High-speed)

Set the communications conditions for the NT Link (1:N) method at serial port A or serial port B by following the operation from the System Menu shown below.

The communications speed determines whether the 1:N NT Link is standard or high-speed.

- Standard: Standard 1:N NT Link
- High-speed: High-speed 1:N NT Link

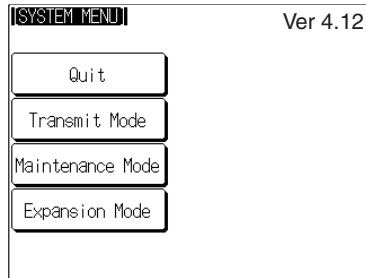

Select Maintenance Mode.

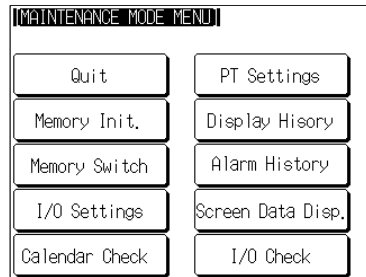

Select Memory Switch.

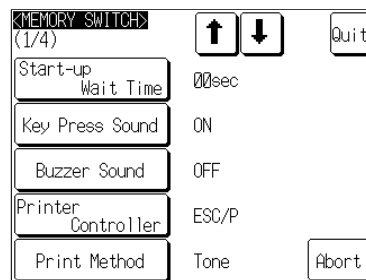

Display the fourth memory switch screen by pressing the [↓] (next screen) or [↑] (previous screen) touch switch.

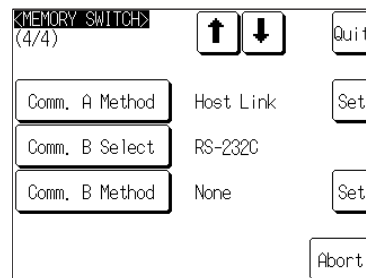

Press the touch switch corresponding to the port at which the NT Link (1:N) method (standard or high-speed) is to be set (Comm. A Method or Comm. B Method) to display the setting option NT Link (1:N).

The setting option changes each time the touch switch is pressed.

In this example, serial port A is used.



Press the Set touch switch to the right of the port at which the setting has been made.

In this example, serial port A is used.

Press the Unit No. touch switch to display the unit number to be set. Press the Comm.

Speed touch switch to display the communications speed, standard or 115.2-kbps high-speed. (The Comm. Speed setting determines which method of 1:N NT Link is used.)

The setting option changes each time the touch switch is pressed. In this example, serial port A is used for a standard 1:N NT Link.

Press Quit.

The unit number is set.

- To quit the unit number/communications speed setting screen without confirming the unit number/communications speed settings, press the Abort touch switch. The NT631/NT631C will return to the memory switch setting screen (4/4) with the previous settings still in effect.

#### Reference:

- Unit numbers are numbers assigned to each PT when multiple PTs are connected to one host, so that the host can identify the individual PTs. The units numbers that can be set differ according to the host model, as follows.
- C200HE(-ZE):  
Unit numbers 0 to 3 (maximum of 4 PTs per host port)
- C200HG(-ZE), C200HX(-ZE):  
Unit numbers 0 to 7 (maximum of 8 PTs per host port)

When making the settings, make sure there is no duplication of unit numbers among PTs.

On completion of unit number setting, the NT631/NT631C returns to the memory switch setting screen (4/4).

To set other memory switches, select the relevant screen using the [↓] (next screen) or [↑] (previous screen) touch switch, then make the setting.

- To confirm the settings and quit the memory switch setting screen, press the Quit touch switch. The settings made last will be set and the NT631/NT631C will return to the MAINTENANCE MODE MENU screen.
- To quit the memory switch setting screen without confirming the settings, press the Abort touch switch. The NT631/NT631C will return to the MAINTENANCE MODE MENU screen with the previous settings still in effect.

### 6-7-5 Setting the Memory Link Method

Set the communications conditions for the host link method at serial port A or serial port B by following the operation from the System Menu shown below. Check the communications settings of the host to be used.

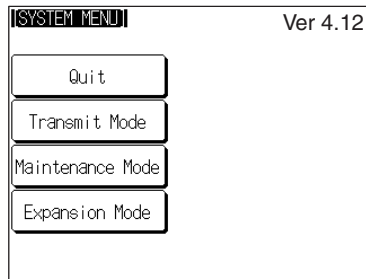

Select Maintenance Mode.

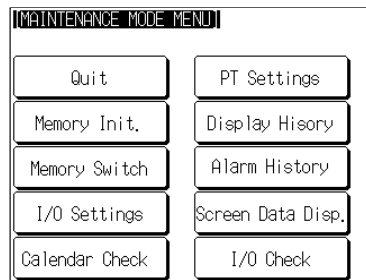

Select Memory Switch.

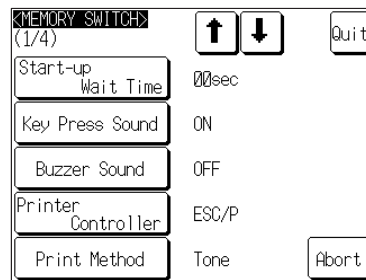

Display the fourth memory switch screen by pressing the [↓] (next screen) or [↑] (previous screen) touch switch.

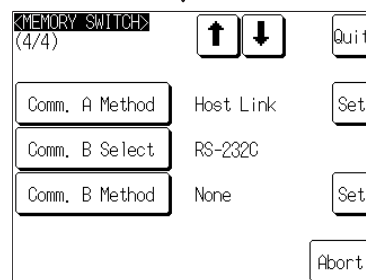

Press the touch switch corresponding to the port at which the memory link method is to be set (Comm. A Method or Comm. B Method) to display the setting option Memory Link.

The setting option changes each time the touch switch is pressed.

In this example, serial port A is used.

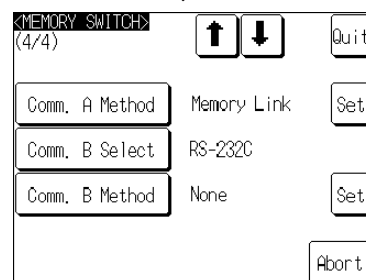

Press the Set touch switch to the right of the port at which the setting has been made.

In this example, serial port A is used.

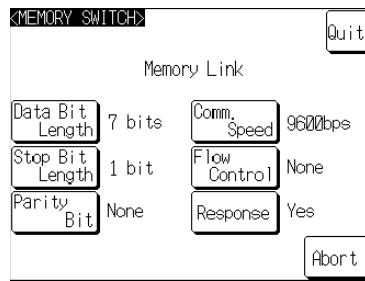

Display the data bits to be set (7 bits or 8 bits) by pressing the Data Bit Length touch switch.

Display the stop bits to be set (1 bit or 2 bits) by pressing the Stop Bit Length touch switch.

Display the parity to be set (None, even, odd) by pressing the Parity Bit touch switch.

Display the communications speed to be set (1200, 2400, 4800, 9600, 19200, 38400 bps.) by pressing the Comm. Speed touch switch.

Display the condition of the flow control to be set (None, RS/CS, XON/XOFF) by pressing Flow Control touch switch.

If the RS-422A is selected for serial port B setting, RS/CS is not displayed.

Display presence or absence of the response by pressing the Response touch switch.

The setting option changes each time the touch switch is pressed.

In this example, serial port A is used.

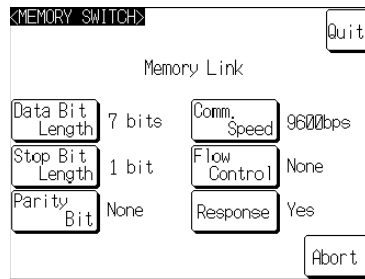

Press the Quit touch switch.

- To quit the communications speed setting screen without setting the communications speed, press the Abort touch switch. The NT631/NT631C returns to the memory switch setting screen (4/4) and the previous communications speed remains in effect.

On completion of communications speed setting, the NT631/NT631C returns to the memory switch setting screen (4/4).

To set other memory switches, select the relevant screen using the [↓] (next screen) or [↑] (previous screen) touch switch, then make the setting.

- To confirm the settings and quit the memory switch setting screen, press the Quit touch switch. The settings made last will be set and the NT631/NT631C will return to the MAINTENANCE MODE MENU screen.
- To quit the memory switch setting screen without confirming the settings, press the Abort touch switch. The NT631/NT631C will return to the MAINTENANCE MODE MENU screen with the previous settings still in effect.

### 6-7-6 Setting the Communications Type for Serial Port B

Set the communications type (RS-232C or RS-422A) for serial port B by following the operation from the System Menu shown below.

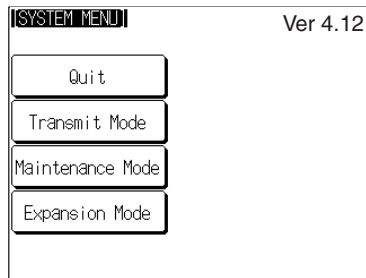

Select Maintenance Mode.

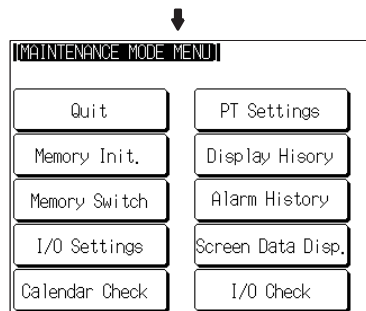

Select Memory Switch.

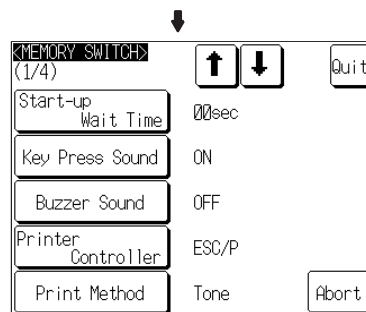

Display the fourth memory switch screen by pressing the [↓] (next screen) or [↑] (previous screen) touch switch.

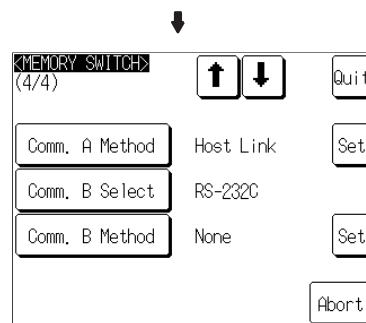

Press the Comm. B Select touch switch to display the communications type to be set. The setting option changes each time the touch switch is pressed.

**Reference:** If serial port B is used for RS-485 communications, RS-422A must be set as its communications type.

To set other memory switches, select the relevant screen using the [↓] (next screen) or [↑] (previous screen) touch switch, then make the setting.

- To confirm the settings and quit the memory switch setting screen, press the Quit touch switch. The settings made last will be set and the NT631/NT631C will return to the MAINTENANCE MODE MENU screen.
- To quit the memory switch setting screen without confirming the settings, press the Abort touch switch. The NT631/NT631C will return to the MAINTENANCE MODE MENU screen with the previous settings still in effect.

## 6-8 Starting Operation

After completing screen data transmission and setting the communications conditions, connect the NT631/NT631C to the host and start operation.

**Note** Check the operation of all screen data and host programs carefully before using them. If incorrect, the system may operate unpredictably.

### Switching to the RUN Mode and Starting Operation

Press the Quit touch switch on the System Menu screen or other screen. The NT631/NT631C switches to the RUN mode and starts operation.

The operation at the start is as follows.

#### **Display of The System Initialization Screen**

When establishing the communications with a host, the System initializing character string is displayed on the screen. If the communications with the host cannot be established, the System initializing screen remains up. If this is the case, check the settings at the host and the PT side, the cables and wiring.

In addition, creating screen number 9000 enables the display of a screen other than the System initialization screen.

#### **Transmission of The Contents of Memory Tables**

If the Resume Function memory switch is set to ON, or if the initial values of the memory tables are used, the contents of the numeral/character-string memory tables are copied to the allocated words at the host.

↓

#### **Display of The Startup Screen**

The startup screen is displayed on reading the contents (screen number of the screen to be displayed) of the first word of the PT status control area.

If the contents are not correct for a screen number, or there is no data registered for the set screen number, an error message is displayed.

### Confirming the Communications between the NT631/NT631C and the Host

Execute the host program and confirm that the following operations are performed normally.

- Confirm that the NT631/NT631C screens switch in accordance with the host program.

If the screens do not switch correctly, check the connection between the host and the NT631/NT631C, and also check if the hardware settings are correct. For details, refer to *SECTION 4 Connecting to the Host from the RS-232C Port*, or *SECTION 5 Connecting to the Host from the RS-422A/485 Port*.

- Confirm that the operation results of touch switch and numeric value/character string input at the NT631/NT631C are sent to the host correctly by displaying the contents of the host words and bits using a Programming Device (e.g. CX-Programmer).

If the results of operations at the NT631/NT631C are not sent to the host correctly, check the setting of the display elements. For details on setting display elements, refer to the description of each display element in the *Reference Manual*.

## 6-9 Various System Settings

The NT631/NT631C allows a variety of functions which are convenient during operation to be set with memory switches. This section describes the memory switch settings relating to the operation environment.

Since the memory switch settings are backed up to the flash memory by the battery in the NT631/NT631C, they are not cleared when the power is switched OFF.

### 6-9-1 Memory Switch Setting Screens

There are four memory switch setting screens. The required screen can be displayed by using the [↓] (next screen) and [↑] (previous screen) touch switches.

The four memory switch setting screens are shown below.

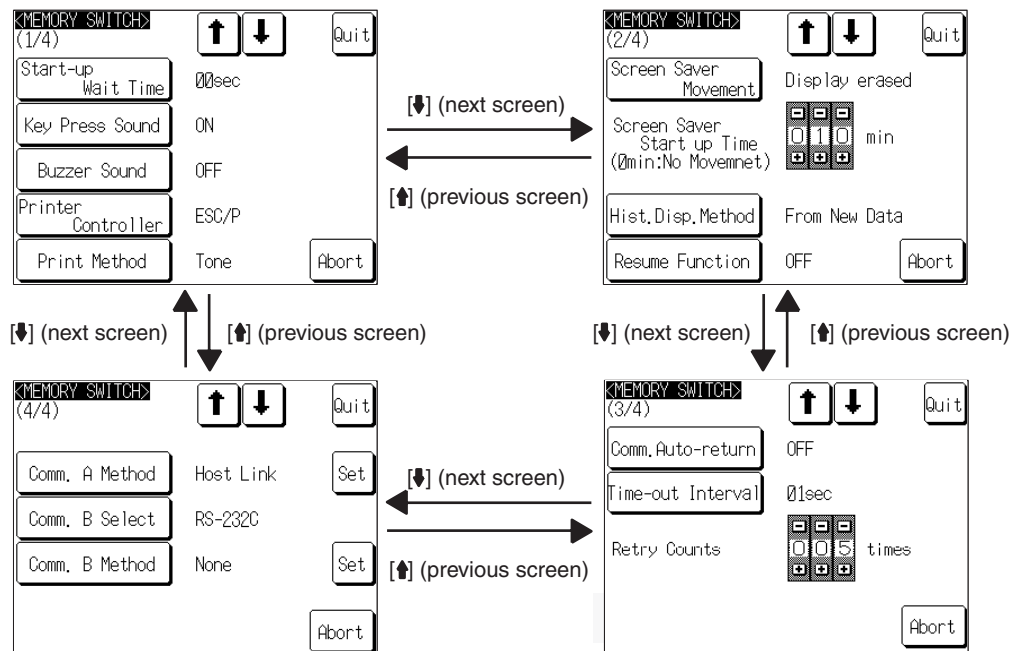

#### Memory Switch Settings

A list of the memory switch settings is presented below.

- Start-up Wait Time page 165
- Key Press Sound page 166
- Buzzer Sound page 166
- Printer Controller page 168
- Print Method page 169
- Screen Saver Movement page 170
- Screen Saver Start up Time page 173
- Hist. Disp. Method page 175
- Resume Function page 177
- Comm. Auto-return page 179
- Time-out Interval page 181
- Retry Counts page 182
- Comm. A Method page 152

(For the bar code reader, refer to page 184.)

- Comm. B Select page 162
- Comm. B Method page 152

For details on each setting, refer to the pages indicated.

## 6-9-2 Setting the Start-up Wait Time

The Start-up Wait Time is the time lapse until the NT631/NT631C switches to the RUN mode after its power has been switched ON or after it has been reset. Set this item if it takes some time for the host to start operation. Nothing is displayed during the Start-up Wait Time.

The setting range is 0 to 10 seconds. The default (factory) setting is 00sec.

Set the system start-up wait time by following the menu operation from the System Menu shown below.

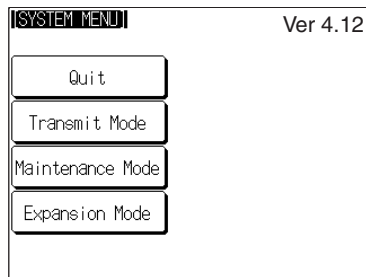

Select Maintenance Mode.

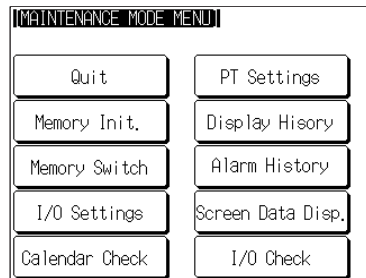

Select Memory Switch.

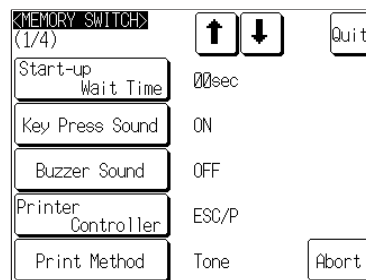

Press Start-up Wait Time to display the required time lapse.

The setting option changes each time the touch switch is pressed, according to the following sequence.

01 02 03 ....09 10 00 01 ....

To set other memory switches, select the relevant screen using the [↓] (next screen) or [↑] (previous screen) touch switch, then make the setting.

- To confirm the settings and quit the memory switch setting screen, press the Quit touch switch. The settings made last will be set and the NT631/NT631C will return to the MAINTENANCE MODE MENU screen.
- To quit the memory switch setting screen without confirming the settings, press the Abort touch switch. The NT631/NT631C will return to the MAINTENANCE MODE MENU screen with the previous settings still in effect.

### 6-9-3 Setting the Key Press Sound

It is possible to set whether or not the key sound is sounded when a touch switch on the NT631/NT631C screen is pressed.

- ON: When a touch switch is pressed, the key sound sounds for 0.2 seconds.
- OFF: The key sound does not sound when touch switches are pressed.

The default (factory) setting is ON.

Set the key press sound by following the menu operation from the System Menu shown below.

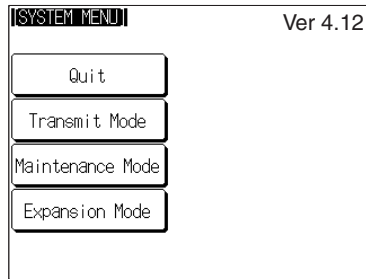

Select Maintenance Mode.

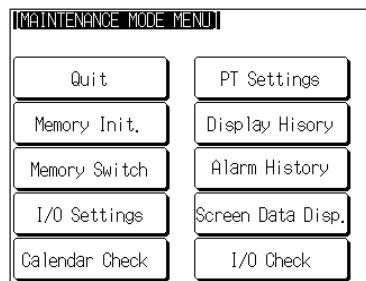

Select Memory Switch.



Press Key Press Sound to display ON or OFF.

The setting option changes each time the touch switch is pressed.

To set other memory switches, select the relevant screen using the [↓] (next screen) or [↑] (previous screen) touch switch, then make the setting.

- To confirm the settings and quit the memory switch setting screen, press the Quit touch switch. The settings made last will be set and the NT631/NT631C will return to the MAINTENANCE MODE MENU screen.
- To quit the memory switch setting screen without confirming the settings, press the Abort touch switch. The NT631/NT631C will return to the MAINTENANCE MODE MENU screen with the previous settings still in effect.

### 6-9-4 Setting the Buzzer Sound

The NT631/NT631C has a function for sounding a buzzer in response to an instruction from the host, or when an error occurs. It is possible to set whether or not the buzzer actually sounds with the memory switches.



- ON:  
The buzzer sounds in response to instructions and when an error occurs.
- OFF:  
The buzzer does not sound in response to instructions or when errors occur.
- ERROR ON:  
The buzzer sounds only when an error occurs.

The default (factory) setting is OFF.

**Reference:**

- There are other instructions and settings relating to the buzzer, but this memory switch setting has the highest priority.
- For details on the buzzer, refer to 2-15-5 Buzzer Function in the *Reference Manual*.

Set the buzzer sound by following the menu operation from the System Menu shown below.

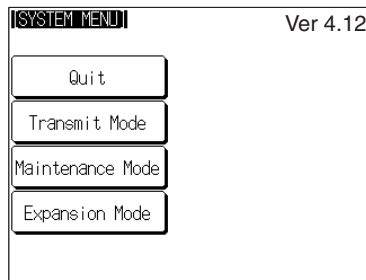

Select Maintenance Mode.

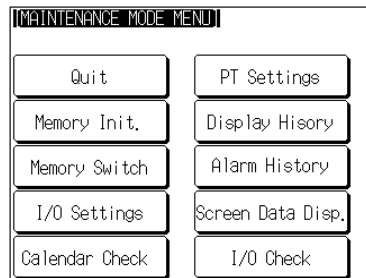

Select Memory Switch.

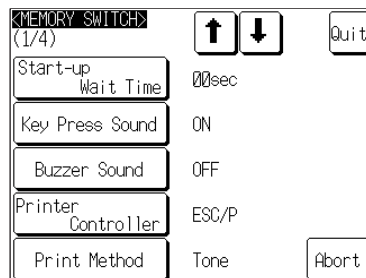

Press Buzzer Sound to display ON, OFF, or ERROR ON.

The setting option changes each time the touch switch is pressed.

To set other memory switches, select the relevant screen using the [↓] (next screen) or [↑] (previous screen) touch switch, then make the setting.

- To confirm the settings and quit the memory switch setting screen, press the Quit touch switch. The settings made last will be set and the NT631/NT631C will return to the MAINTENANCE MODE MENU screen.
- To quit the memory switch setting screen without confirming the settings, press the Abort touch switch. The NT631/NT631C will return to the MAINTENANCE MODE MENU screen with the previous settings still in effect.

## 6-9-5 Setting the Printer Controller

The NT631/NT631C has a function for printing out data at a printer connected to it in response to an instruction from the host or operation at the NT631/NT631C. Three types of printer can be connected to the NT631/NT631C: select the type used with this memory switch setting.

- ESC/P:

Printers that conform to Epson's ESC/P 24-J83C (color) printer control specifications or printers that conform to Epson's ESC/P 24-J82 (monochrome) control specifications.

- PC-PR201H:

Printers that can emulate the PC-PR201H, made by NEC Corp.

- PCL 5:

Printers that conform to the PCL 5 printer control specifications.

Note that the NT631 can only be used with the monochrome Tone setting and does not support color printing.

For the NT631, the Print Method is fixed as Tone.

The default (factory) setting is ESC/P.

**Reference:**

- In addition to this setting, NT631C has the Print Method setting (page 169).
- For details on the print function, refer to *2-15-7 Print Function* in the *Reference Manual*.

Set the printer controller setting by following the menu operation from the System Menu shown below.

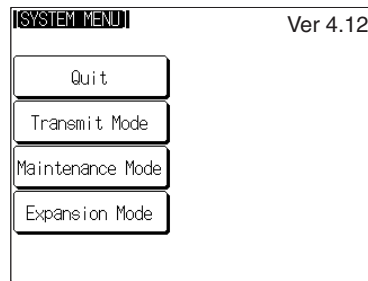

Select Maintenance Mode.

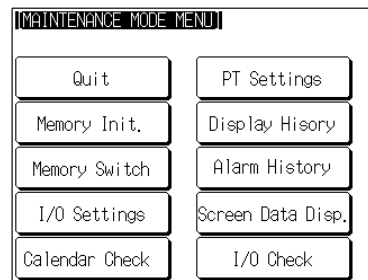

Select Memory Switch.

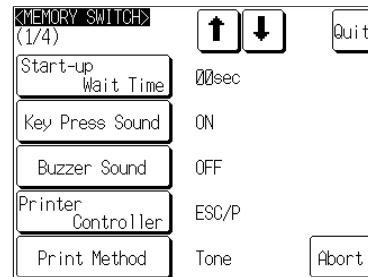

Press Printer Controller to display the required printer type.

The setting option changes each time the touch switch is pressed.

To set other memory switches, select the relevant screen using the [↓] (next screen) or [↑] (previous screen) touch switch, then make the setting.

- To confirm the settings and quit the memory switch setting screen, press the Quit touch switch. The settings made last will be set and the NT631/NT631C will return to the MAINTENANCE MODE MENU screen.
- To quit the memory switch setting screen without confirming the settings, press the Abort touch switch. The NT631/NT631C will return to the MAINTENANCE MODE MENU screen with the previous settings still in effect.

### 6-9-6 Setting the Print Method (NT631C Only)

The NT631/NT631C has a function for printing out data at a printer connected to it in response to an instruction from the host or operation at the NT631/NT631C.

When using the NT631C, the currently displayed screen image or other data can be printed out in color. You can select whether screen data is actually printed out in color, or in monochrome tones that represent colors, with this memory switch setting.

When PCL 5 is set for Printer Controller, the setting is fixed as Tone.

- Color: Color images are printed in color.
- Tone: Color images are printed in monochrome tones.

The default (factory) setting is Tone.

- Reference:**
- In addition to this setting, NT631C has the Printer Controller setting (page 168).

- For details on the print function, refer to 2-15-7 *Print Function* in the *Reference Manual*.

Set the print method setting by following the menu operation from the System Menu shown below.

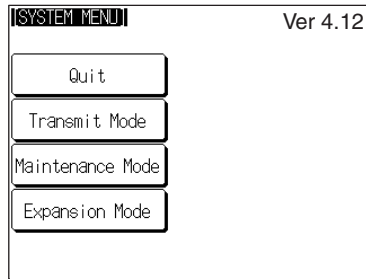

Select Maintenance Mode.

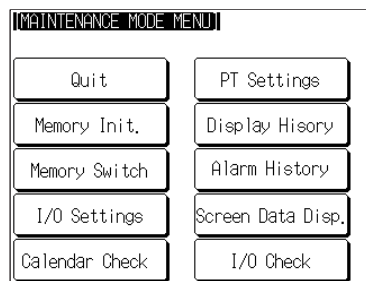

Select Memory Switch.

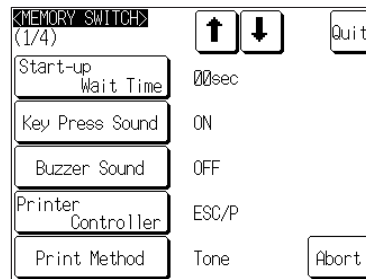

Press Print Method to display the required printing method.

The setting option changes each time the touch switch is pressed.

To set other memory switches, select the relevant screen using the [↓] (next screen) or [↑] (previous screen) touch switch, then make the setting.

- To confirm the settings and quit the memory switch setting screen, press the Quit touch switch. The settings made last will be set and the NT631/NT631C will return to the MAINTENANCE MODE MENU screen.
- To quit the memory switch setting screen without confirming the settings, press the Abort touch switch. The NT631/NT631C will return to the MAINTENANCE MODE MENU screen with the previous settings still in effect.

### 6-9-7 Setting Screen Saver Movement

The NT631/NT631C has a function to prevent the formation of an afterimage by turning off the screen display if no operation is performed for a certain period of time, and then displaying character strings at random positions and in random colors (the colors only change for the NT631C).

The Screen Saver Movement setting determines whether or not these character strings are displayed while the screen display is off.

If Display is selected, the character string stored in character string memory table No. 0 is displayed.

If Display erase is selected, the character string is not displayed, and the backlight is also turned off while the screen display is off.

The default (factory) setting is Display erased.

The screen saver can be canceled, and former screen redisplayed, by any of the following operations.

- Touching any part of the touch panel
- Screen switching due to PT status control area operations
- Screen switching due to bit memory table operations
- Execution of any of the following PT status control bit operations:
  - Changing the backlight mode
  - Screen printing (change from OFF to ON)
  - Screen display (change from OFF to ON)

**Reference:**

- The time before the screen is turned OFF is set by the Screen Saver Start up Time setting. For details, refer to *6-9-8 Setting the Screen Saver Start-up Time* (page 173).
- Even if its operation has been set with the Screen Saver Movement setting, the screen saver function will not be executed if 000 is set for Screen Saver Start up Time.
- Screen saver function is enabled only through RUN mode of NT631/NT631C. In System Menu or System Installer mode, this function is not started.

Set the screen saver operation by following the menu operation from the System Menu shown below.

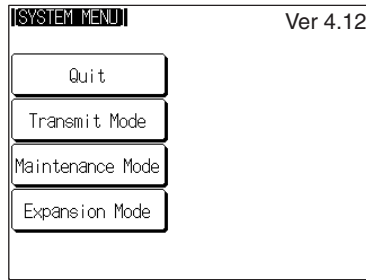

Select Maintenance Mode.

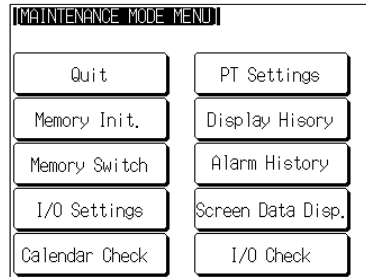

Select Memory Switch.

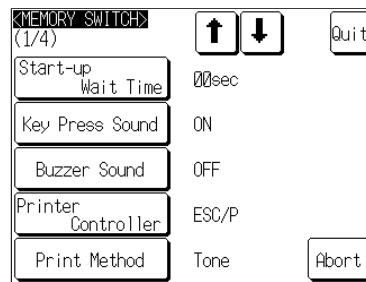

Press [↓] (next screen) or [↑] (previous screen) to display the second memory switch setting screen.

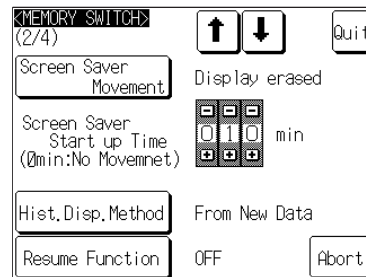

Press Screen Saver Movement to display Display or Display erased. The setting option changes each time the touch switch is pressed.

To set other memory switches, select the relevant screen using the [↓] (next screen) or [↑] (previous screen) touch switch, then make the setting.

- To confirm the settings and quit the memory switch setting screen, press the Quit touch switch. The settings made last will be set and the NT631/NT631C will return to the MAINTENANCE MODE MENU screen.
- To quit the memory switch setting screen without confirming the settings, press the Abort touch switch. The NT631/NT631C will return to the MAINTENANCE MODE MENU screen with the previous settings still in effect.

## 6-9-8 Setting the Screen Saver Start-up Time

The NT631/NT631C has a function to maximize the service life of the backlight and prevent the formation of an afterimage by turning off the screen display and the backlight if no operation is performed for a certain period of time. The Screen Saver Start up Time setting determines the time interval before the screen saver function operates.

The setting range is 0 to 255 minutes. The default (factory) setting is 10 minutes. If 000 is set, the screen saver function does not operate.

The screen saver can be canceled, and previous screen redisplayed, by any of the following operations.

- Touching any part of the touch panel
- Screen switching due to PT status control area operations
- Screen switching due to bit memory table operations
- Execution of any of the following PT status control bit operations:
  - Changing the backlight mode
  - Screen printing (change from OFF to ON)
  - Screen display (change from OFF to ON)

**Reference:**

- It is possible to display the character string stored in character string memory table No. 0 at random positions and in random colors while the screen display is off. For details, refer to *6-9-7 Setting Screen Saver Movement* (page 170). Note however that, when this feature is used, the backlight does not go off.
- For details on the screen saver function, refer to *6-9-7 Setting Screen Saver Movement* (page 170).
- Screen saver function is enabled only through RUN mode of NT631/NT631C. In System Menu or System Installer mode, this function is not started.

Set the screen saver start-up time by following the menu operation from the System Menu shown below.

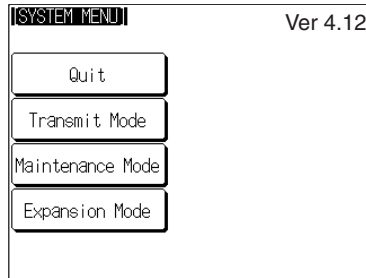

Select Maintenance Mode.

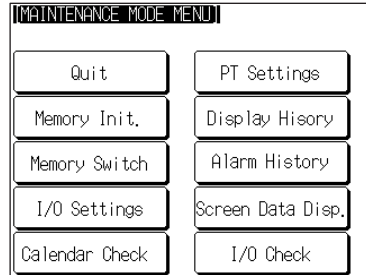

Select Memory Switch.

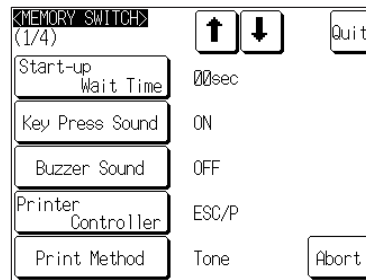

Press [↓] (next screen) or [↑] (previous screen) to display the second memory switch setting screen.

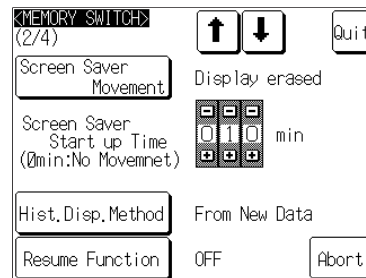

Set a time in the input field to the right of Screen Saver Start up Time. Each of the digits can be incremented or decremented by pressing the associated + and - keys.

To set other memory switches, select the relevant screen using the [↓] (next screen) or [↑] (previous screen) touch switch, then make the setting.

- To confirm the settings and quit the memory switch setting screen, press the Quit touch switch. The settings made last will be set and the NT631/NT631C will return to the MAINTENANCE MODE MENU screen.
- To quit the memory switch setting screen without confirming the settings, press the Abort touch switch. The NT631/NT631C will return to the MAINTENANCE MODE MENU screen with the previous settings still in effect.



### 6-9-9 Setting the History Display Method

The NT631/NT631C features the display history record function, which records the time at which screens are displayed during operation and the number of times they are displayed, and the alarm history record function, which continually monitors bit statuses at the host and records the time when bits come ON and the number of times they come ON.

The Hist. Disp. Method setting determines whether — when these record data are displayed in sort by occurrence — the records are displayed in a progression from newest to oldest or from oldest to newest.

- From Old Data:

The records are displayed in sequence from the oldest to newest.

- From New Data:

The records are displayed in sequence from the newest to oldest.

The default (factory) setting is From New Data.

**Reference:**

- When the voltage of the NT631/NT631C's built-in battery becomes low, the history record contents cannot be retained.
- For details on the display history record function and the alarm history record function, refer to *2-15-1 Display History Record Function* and *2-15-2 Alarm History Record Function* in the *Reference Manual*.

Set the history display method by following the menu operation from the System Menu shown below.

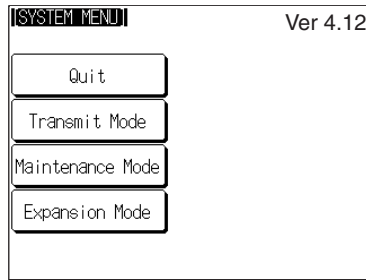

Select Maintenance Mode.

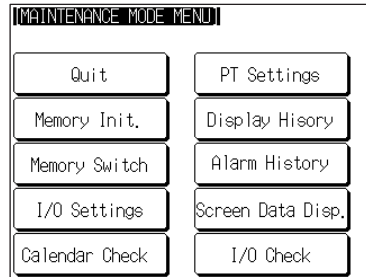

Select Memory Switch.

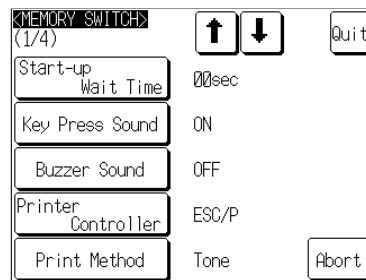

Press [↓] (next screen) or [↑] (previous screen) to display the second memory switch setting screen.

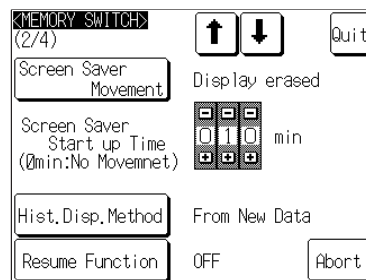

Press Hist. Disp. Method to display the required display order. The setting option changes each time the touch switch is pressed.

To set other memory switches, select the relevant screen using the [↓] (next screen) or [↑] (previous screen) touch switch, then make the setting.

- To confirm the settings and quit the memory switch setting screen, press the Quit touch switch. The settings made last will be set and the NT631/NT631C will return to the MAINTENANCE MODE MENU screen.
- To quit the memory switch setting screen without confirming the settings, press the Abort touch switch. The NT631/NT631C will return to the MAINTENANCE MODE MENU screen with the previous settings still in effect.

## 6-9-10 Setting the Resume Function

The NT631/NT631C has a function to keep the contents of the memory tables even when the power to the NT631/NT631C is OFF and write back them to the host when the power is turned ON.

If the resume function is OFF, the memory tables are initialized to these initial values on switching to the RUN mode. If the resume function is ON, these are not initialized and are kept the battery-backed up contents.

When the memory table is initialized, its contents are reset to the initial state that is set by the Support Tool.

When the system is started up the next time, the screen is displayed using the previous contents of the memory table.

- ON: The resume function is used.
- OFF: The resume function is not used.

The default (factory) setting is OFF.

**Reference:**

- When the voltage of the NT631/NT631C's built-in battery becomes low, the memory table contents cannot be retained even if ON is set for the resume function.
- For details on the resume record function, refer to *2-15-3 Resume Function* in the *Reference Manual*.

Set the resume function by following the menu operation from the System Menu shown below.

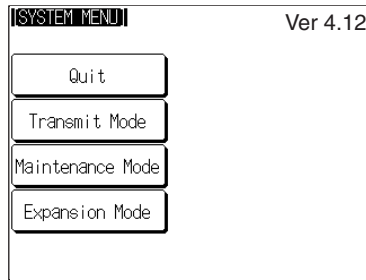

Select Maintenance Mode.

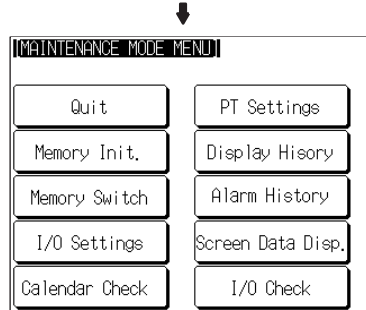

Select Memory Switch.

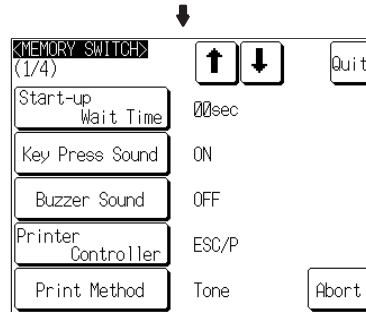

Press [↓] (next screen) or [↑] (previous screen) to display the second memory switch setting screen.

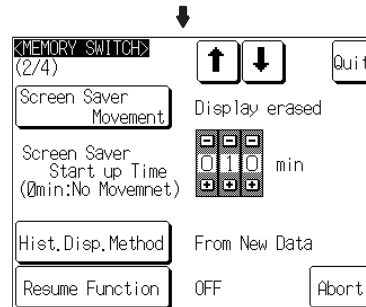

Press Resume Function to display the required setting. The setting option changes each time the touch switch is pressed.

To set other memory switches, select the relevant screen using the [↓] (next screen) or [↑] (previous screen) touch switch, then make the setting.

- To confirm the settings and quit the memory switch setting screen, press the Quit touch switch. The settings made last will be set and the NT631/NT631C will return to the MAINTENANCE MODE MENU screen.
- To quit the memory switch setting screen without confirming the settings, press the Abort touch switch. The NT631/NT631C will return to the MAINTENANCE MODE MENU screen with the previous settings still in effect.

## 6-9-11 Setting the Automatic Reset Function

The NT631/NT631C has a function for ignoring communications errors and automatically returning to the RUN mode when they occur.

The Comm. Auto-return setting determines whether the automatic reset function is effective or not.

- ON:

When a communications error occurs, the NT631/NT631C automatically returns to the RUN mode without displaying an error screen (the System Initializing screen may be displayed).

- OFF:

When a communications error occurs, an error screen is displayed and operation stops. Pressing OK on the error screen returns the NT631/NT631C to the RUN mode.

The default (factory) setting is OFF.

**Reference:**

- If a communications error occurs when OFF is set for Comm. Auto-return, the NT631/NT631C makes the number of attempts at communications with the host specified by the setting for the Retry Counts touch switch (page 182). If communications cannot be re-established in any of these attempts, an error screen is displayed.
- For details on communications errors, refer to *7-2-5 Communications Errors and Their Remedies* (page 233).

Set the automatic reset function by following the menu operation from the System Menu shown below.

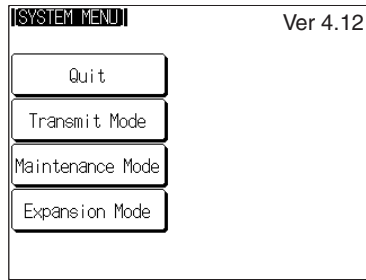

Select Maintenance Mode.

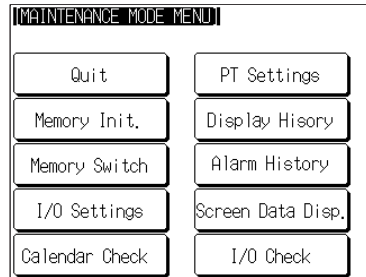

Select Memory Switch.

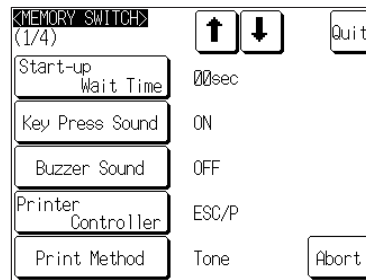

Press [↓] (next screen) or [↑] (previous screen) to display the third memory switch setting screen.

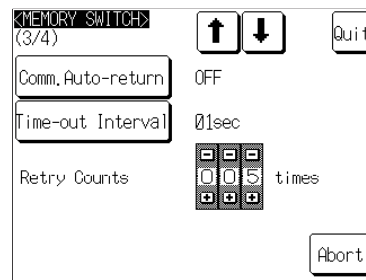

Press Comm. Auto-return to display the required setting. The setting option changes each time the touch switch is pressed.

To set other memory switches, select the relevant screen using the [↓] (next screen) or [↑] (previous screen) touch switch, then make the setting.

- To confirm the settings and quit the memory switch setting screen, press the Quit touch switch. The settings made last will be set and the NT631/NT631C will return to the MAINTENANCE MODE MENU screen.
- To quit the memory switch setting screen without confirming the settings, press the Abort touch switch. The NT631/NT631C will return to the MAINTENANCE MODE MENU screen with the previous settings still in effect.

### 6-9-12 Setting the Time-out Interval

The NT631/NT631C goes into the time-out error status if no response is received from the host within a fixed time. The Time-out Interval setting specifies the time lapse at which time-out is judged to have occurred.

The setting range is 1 to 10 seconds. The default (factory) setting is 1 second.

**Reference:** Whether or not an error screen is displayed when a time-out error occurs is determined by the setting for the Comm. Auto-return memory switch.

Set the time-out interval by following the menu operation from the System Menu shown below.

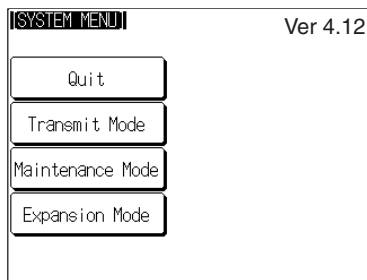

Select Maintenance Mode.

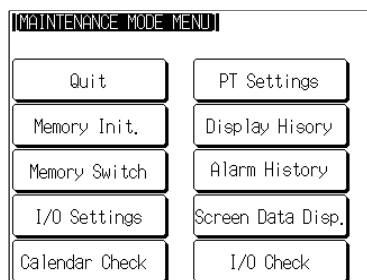

Select Memory Switch.

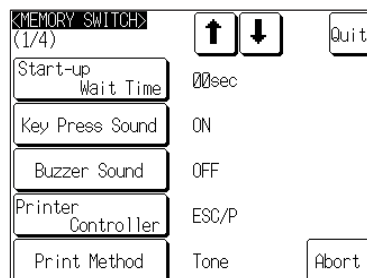

Press [↓] (next screen) or [↑] (previous screen) to display the third memory switch setting screen.

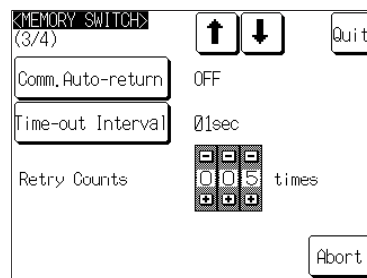

Press Time-out Interval to display the required time lapse. The setting option changes each time the touch switch is pressed, according to the following sequence. 01 02 03 .... 09 10 01 ....

To set other memory switches, select the relevant screen using the [↓] (next screen) or [↑] (previous screen) touch switch, then make the setting.

- To confirm the settings and quit the memory switch setting screen, press the Quit touch switch. The settings made last will be set and the NT631/NT631C will return to the MAINTENANCE MODE MENU screen.
- To quit the memory switch setting screen without confirming the settings, press the Abort touch switch. The NT631/NT631C will return to the MAINTENANCE MODE MENU screen with the previous settings still in effect.

### 6-9-13 Setting the Retry Count

The NT631/NT631C does not immediately display an error screen when a communications error occurs, but tries to re-establish communications. The Retry Counts setting specifies the number of attempts to be made to re-establish communications. If communications cannot be recovered within this number of attempts, the following happens depending on the setting made for the Comm. Auto-return memory switch (page 179).

**Comm. Auto-return ON:**

Operation in the RUN mode is continued without displaying an error screen. Regardless of the setting made for Retry Counts, attempts to re-establish communications are repeated until normal communications are achieved.

**Comm. Auto-return OFF:**

The RUN mode is ended and an error screen is displayed. On pressing the OK touch switch on the error screen, the screen displayed immediately before is redisplayed and attempts are made to re-establish communications.

The System Menu can be displayed from the error screen by pressing any two of the four corners of the touch panel simultaneously.

The setting range is 0 to 255 times. The default (factory) setting is 5 times.

**Reference:** For details on communications errors, refer to *7-2-5 Communications Errors and Their Remedies* (page 233).



Set the retry count by following the menu operation from the System Menu shown below.

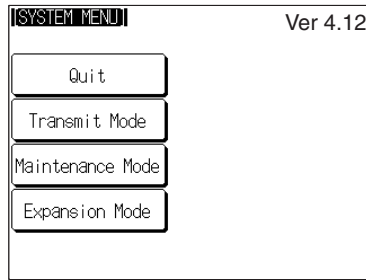

Select Maintenance Mode.

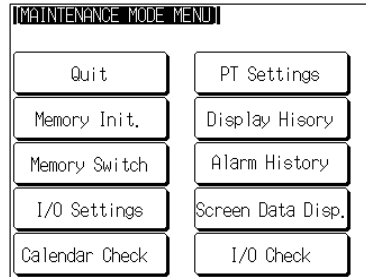

Select Memory Switch.

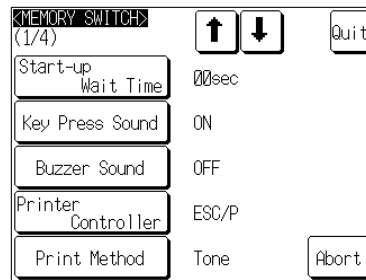

Press [↓] (next screen) or [↑] (previous screen) to display the third memory switch setting screen.

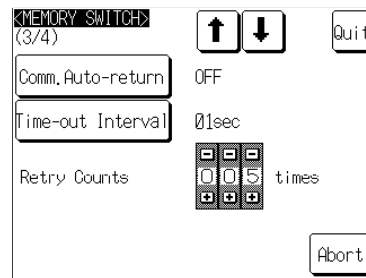

Set a number of times in the input field to the right of Retry Counts. Each of the digits can be incremented or decremented by pressing the associated + and - keys.

To set other memory switches, select the relevant screen using the [↓] (next screen) or [↑] (previous screen) touch switch, then make the setting.

- To confirm the settings and quit the memory switch setting screen, press the Quit touch switch. The settings made last will be set and the NT631/NT631C will return to the MAINTENANCE MODE MENU screen.
- To quit the memory switch setting screen without confirming the settings, press the Abort touch switch. The NT631/NT631C will return to the MAINTENANCE MODE MENU screen with the previous settings still in effect.

## 6-10 Setting the Bar Code Reader Input Function

The NT631/NT631C has a bar code reader input function which allows a bar code reader to be connected and bar code data to read as character strings into character string input fields.

This section describes the communications conditions for the bar code reader and the setting method for confirming the input data.

- Reference:**
- For details on bar code reader types and connection methods, refer to *3-4 Connecting a Bar Code Reader* in this manual and for details on how to use a bar code reader refer to *3-7 Input of Numeric Values and Character Strings* in the *Reference Manual*.
  - The bar code reader is connected to serial port A. This means that serial port B must be used for communications with the host.

### Communications Condition Settings for Bar Code Readers

| Setting Item         | Function   | Setting Options           | Page |
|----------------------|--|---------------------------|------|
| Data bit length      | Sets the bit length for the data bits.   | 7* or 8 bits              | 186  |
| Stop bit length      | Sets the stop bit length for the data.   | 1 or 2* bits              | 186  |
| Parity bit           | Sets the parity bit for the data.  | None, odd, even*          | 186  |
| Communications speed | Sets the communications speed for the bar code reader  | 4800, 9600*, or 19200 bps | 186  |
| Input method         | Sets the method for confirming data when it is input to a character string input field.<br>Manual: The data is confirmed with a touch switch. The data can be corrected and character strings can be added.<br>Auto: The data is automatically confirmed when it is input. | Manual*, Auto             | 186  |

\* Default (factory) setting

**Setting the Communications Conditions and Setting Method**

Set the bar code reader communications conditions and method of confirmation at input by following the menu operation from the System Menu shown below.

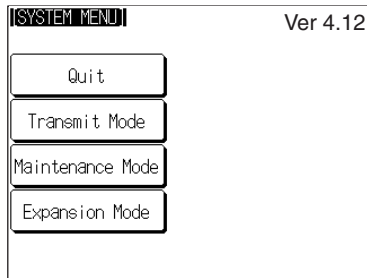

Select Maintenance Mode.

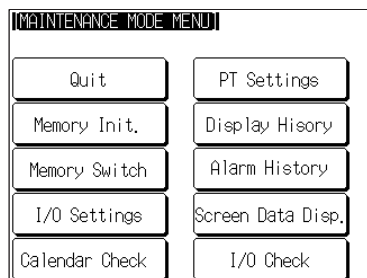

Select Memory Switch.

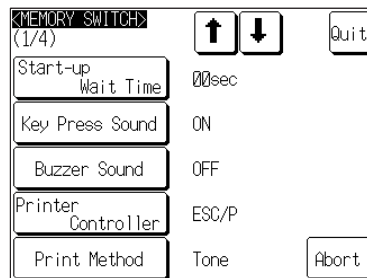

Press [↓] (next screen) or [↑] (previous screen) to display the fourth memory switch setting screen.

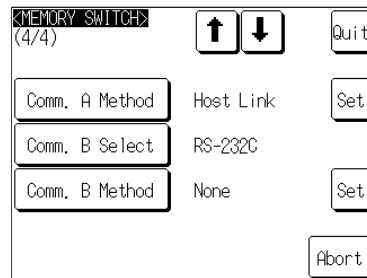

Press Comm. A Method to select Bar-Code Reader. The setting option changes each time the touch switch is pressed.



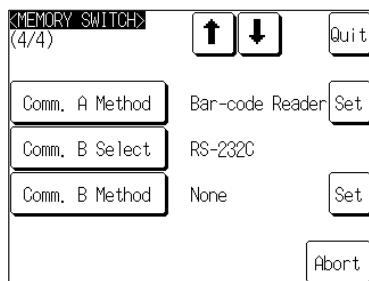

Press the Set touch switch to the right of Comm. A Method.

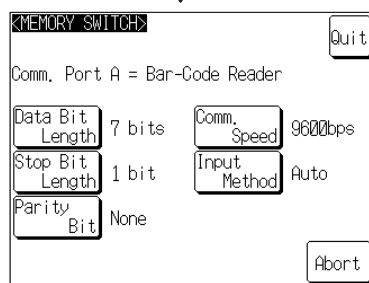

Display the required setting for each item by pressing the touch switches. The setting option changes each time the touch switch is pressed.

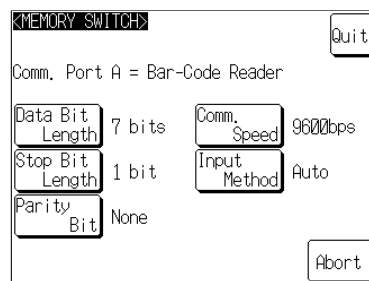

Press Quit.

- Pressing Abort on the communications condition/confirmation method setting screen causes the NT631/NT631C to return to the memory switch setting screen (4/4) without executing setting (with the previous settings still effective).

On completion of communications condition/confirmation method setting, the NT631/NT631C returns to the memory switch setting screen (4/4).

To set other memory switches, select the relevant screen using the [↓] (next screen) or [↑] (previous screen) touch switch, then make the setting.

- To confirm the settings and quit the memory switch setting screen, press the Quit touch switch. The settings made last will be set and the NT631/NT631C will return to the MAINTENANCE MODE MENU screen.
- To quit the memory switch setting screen without confirming the settings, press the Abort touch switch. The NT631/NT631C will return to the MAINTENANCE MODE MENU screen with the previous settings still in effect.

## 6-11 System Maintenance

The NT631/NT631C has the following maintenance and check functions.

| Item                   |              | Function  | Page |
|------------------------|--------------|---|------|
| I/O Settings           |              | Adjustment of display panel contrast and brightness of the backlight.   | 187  |
| Calendar Check         |              | Display and setting of the time data of the NT631/NT631C clock function.  | 191  |
| PT Settings            |              | Direct connection setting of the screen data in the NT631/NT631C and display of the setting statuses of the serial ports. | 193  |
| Display history record |              | Display and printing of display history record data.  | 194  |
| Alarm history record   |              | Display and printing of alarm history record data.  | 196  |
| Screen data check      |              | Display of each screen stored in the NT631/NT631C.  | 198  |
| I/O check              | Device check | Checking of the I/O functions of the NT631/NT631C.  | 201  |
|                        | I/F check    | Checking of the communications functions of the NT631/NT631C.   | 209  |

This section describes how to use these functions.

### 6-11-1 I/O Settings

This function is used to adjust the contrast of the display panel and the brightness of the backlight.

With the NT631/631C, you can adjust the contrast and brightness settings using either of the following two methods.

#### Setting from the System Menu

Adjusting the contrast: Select System Menu/Maintenance Mode/I/O Settings/Contrast Adjust.

Adjusting the brightness: Select System Menu/Maintenance Mode/I/O Settings/Brightness Adjust.

#### Setting Using Special Screen During PT Operation

You can set the brightness and contrast by displaying the screen with the following number, using a touch switch with a switch screen function, or by specifying the display screen in the PT status control area.

Screen number 9030: Brightness and contrast adjustment screen.

#### Contrast Adjustment (for NT631C-ST141□-EV1 only)

The NT631C-ST141□-EV1 allows the contrast to be adjusted in 100 steps. The CONTRAST ADJUST screen enables you to make the adjustment while actually checking the contrast on the screen. Once the contrast has been set, it remains in effect even if the power is turned OFF or the NT631/NT631C is reset (and even if the voltage of the built-in battery becomes low).

**Setting from the System Menu**

Adjust the contrast of the display panel by following the menu operation from the System Menu shown below.

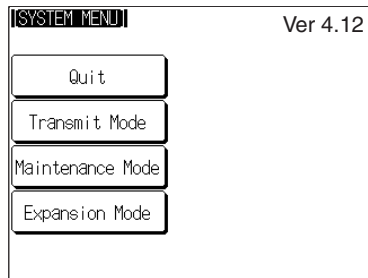

Select Maintenance Mode.

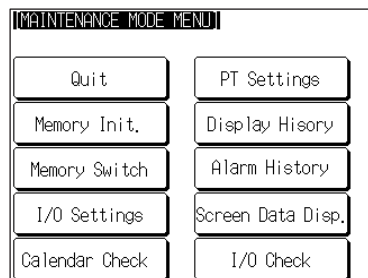

Select I/O Settings.

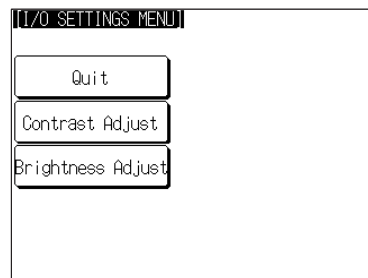

Select Contrast Adjust.

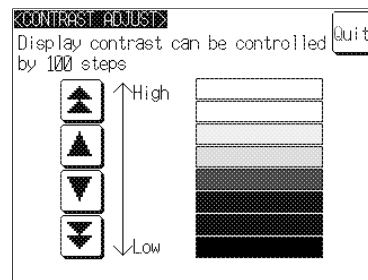

Adjust the contrast with the touch switches in the left half of the screen.

- [▲▲]: Increase 10 steps
- [▲]: Increase 1 step
- [▼]: Decrease 1 step
- [▼▼]: Decrease 10 steps

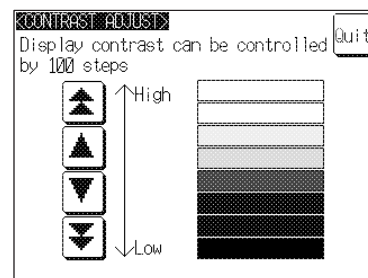

Press Quit.

The contrast is set and the NT631/NT631C returns to the I/O SETTINGS MENU screen.

### Setting Using Brightness and Contrast Adjustment Screen

Display screen number 9030 using either a touch switch with switch screen function, or by specifying the display screen in the PT status control area.

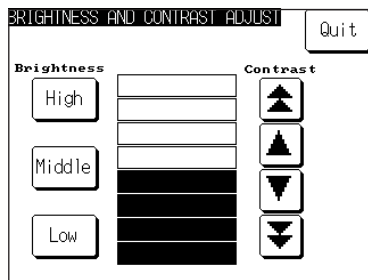

Adjust the contrast with the touch switches in the right half of the screen.

- [↑↑]: Increase 10 steps
- [▲]: Increase 1 step
- [▼]: Decrease 1 step
- [↓↓]: Decrease 10 steps

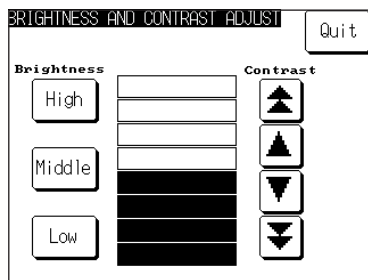

Press Quit.

The contrast is set, and the NT631/NT631C returns to the previous screen.

### Backlight Brightness Adjustment (for NT631C-ST141□-EV□ only)

The NT631C-ST141□-EV□ allows the brightness of the backlight to be adjusted in 3 steps. The BRIGHTNESS ADJUST screen enables you to make the adjustment while actually checking the brightness on the screen.

**Reference:** In the NT631C-ST153□-EV3, adjustment is not possible even though this screen is displayed.

Adjust the backlight brightness by following the menu operation from the System Menu shown below.

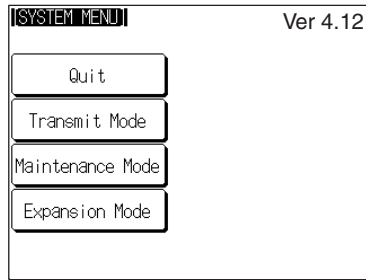

Select Maintenance Mode.

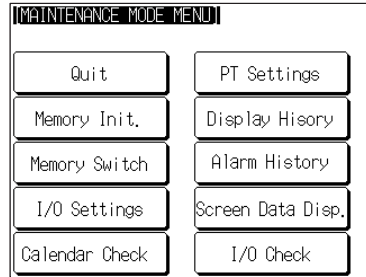

Select I/O Settings.

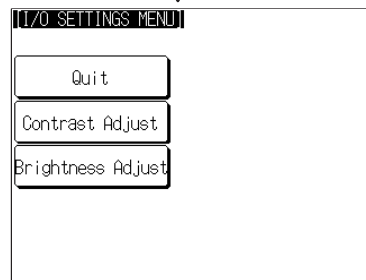

Select Brightness Adjust.

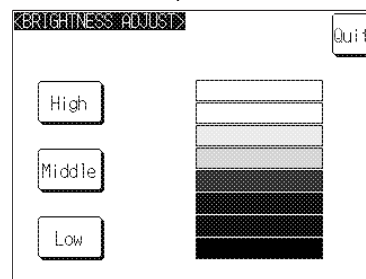

Adjust the contrast with the High, Middle, and Low touch switches in the left half of the screen.

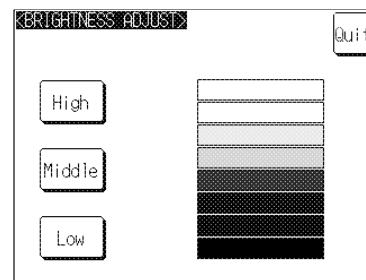

Press Quit.

The contrast is set and the NT631/NT631C returns to the I/O SETTINGS MENU screen.



### Setting Using Brightness and Contrast Adjustment Screen

Display screen number 9030 using either a touch switch with switch screen function, or by specifying the display screen in the PT status control area.

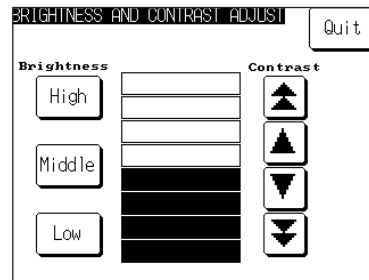

Adjust the brightness with the touch switches (High, Middle, Low) in the left half of the screen.

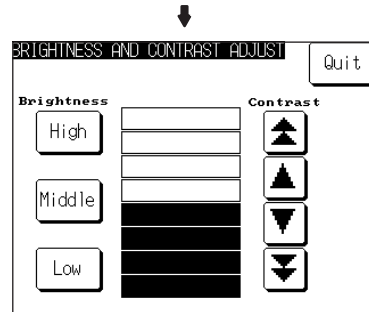

Press Quit.

The brightness is set, and the NT631/NT631C returns to the previous screen.

## 6-11-2 Displaying/Setting the Calendar and Clock

The NT631/NT631C has a clock function for setting and displaying the date and time.

This section describes how to display and set the clock data by menu operation from the System Menu.

#### Reference:

- The clock function does not strictly check the date and day of the week settings. When setting the clock data, be sure to set the correct date and day of the week. If a mistake is made — for example entering a value in the range 13 to 19 when entering the month — the buzzer sounds three times.  
Make sure that the data is correct when the month changes.
- Numeral memory tables 247 to 255 are reserved for the clock function. Clock data can be displayed and set during operation of the NT631/NT631C by using these numeral memory tables.
- For details on the clock function, refer to *3-10 Display and Setting of Calendar Clock* in the *Reference Manual*.
- No clock data is set on shipment from the factory.
- The clock data is backed up by the built-in battery of the NT631/NT631C. If the battery voltage becomes low, the clock data cannot be retained when the power to the NT631/NT631C is turned OFF or the NT631/NT631C is reset and the clock function will not operate correctly.
- When writing to the screen data memory is disabled by the setting made for System Setting in the System Installer mode, it is not possible to set the date and time.

Display/set clock data by following the menu operation from the System Menu shown below.

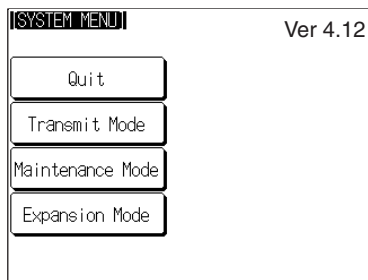

Select Maintenance Mode.

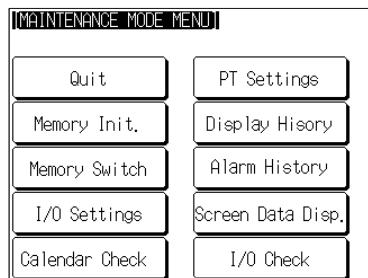

Select Calendar Check.

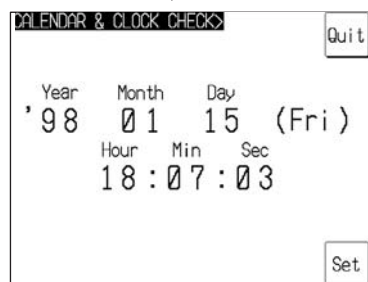

Press Set.

If you are just checking the display, press Quit at this point; the NT631/NT631C will return to the MAINTENANCE MODE MENU screen.

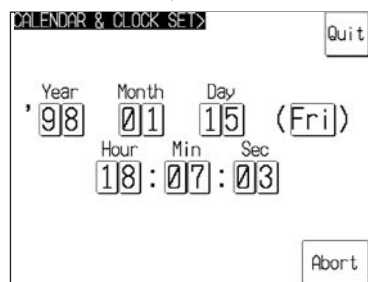

Set the date.

Each of the digits of the year, month, date, hour, minute, and second settings, and the day of the week setting, are touch switches: press these touch switches to change the corresponding settings.

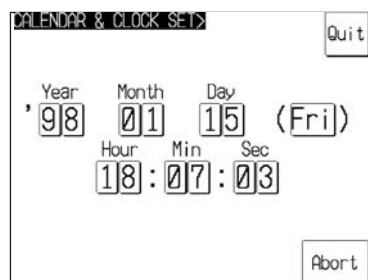

Press Quit.

The clock data is set and the NT631/NT631C returns to the date and time display.

Pressing Abort causes the NT631/NT631C to return to the date and time display without executing setting (with the previous settings still effective).

### 6-11-3 Checking the PT Setting Status

The direct connection settings of the NT631/NT631C screen data, and the settings for serial port A and serial port B, can be checked.

#### Screen Configuration and Display Contents

There are the following three PT setting status screens.

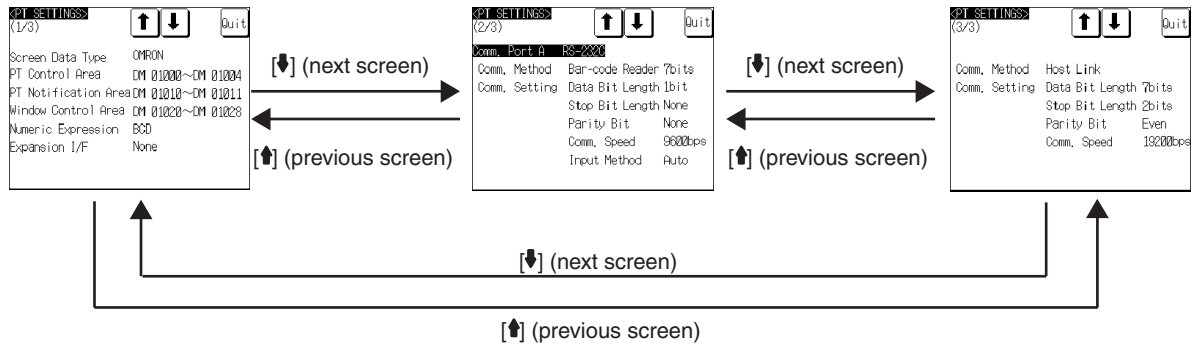

#### Display Contents of The First Screen

| Item                 | Meaning   |
|----------------------|---|
| Screen Data Type     | The host type set for the screen data   |
| PT Control Area      | Word at the host to which the PT status control area is allocated   |
| PT Notification Area | Word at the host to which the PT status notify area is allocated  |
| Window Control Area  | Word at the host to which the window control area is allocated  |
| Numeric Expression   | Default for the method of interpretation of the contents of host words to which numeral memory tables are allocated (numeric value storage method).               |
| Expansion I/F        | Type of Unit installed at the expansion interface connector   |
| Compatibility        | Sets whether or not to use NT30/620 compatible mode for screen data. (Sets whether to operate as a normal NT31/631 or emulate many key NT30/620 characteristics.) |

#### Display Contents of The Second Screen

| Item          | Meaning  |
|---------------|--|
| Comm. Port A  | Communications type set for serial port A (fixed as RS-232C)   |
| Comm. Method  | Communications method set for serial port A  |
| Comm. Setting | Communications conditions set for serial port A (display contents differ according to the communications method) |

#### Display Contents of The Third Screen

| Item          | Meaning  |
|---------------|--|
| Comm. Port B  | Communications type set for serial port B (RS-232C/RS-422A)  |
| Comm. Method  | Communications method set for serial port B  |
| Comm. Setting | Communications settings set for serial port B (display contents differ according to the communications method) |

**Display Method**

Display the PT setting statuses by following the menu operation from the System Menu shown below.

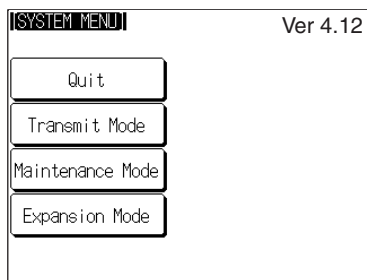

Select Maintenance Mode.

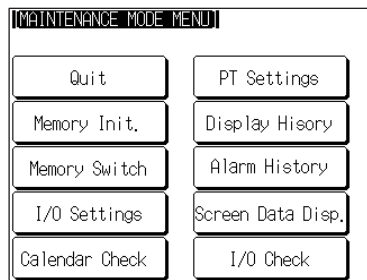

Select PT Settings.

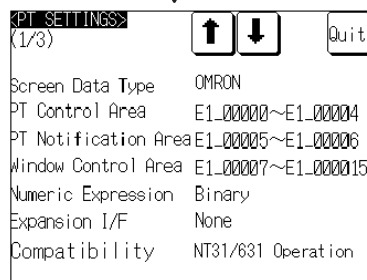

Switch the screen as required by pressing the [↓] (next screen) or [↑] (previous screen) touch switch.

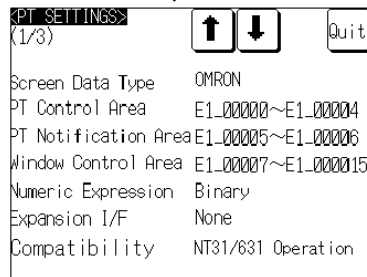

Press Quit.

The NT631/NT631C returns to the MAINTENANCE MODE MENU screen.

**6-11-4 Displaying and Printing the Display History Record**

The display history record function is a function that records the order of display of each screen during operation, and the number of times each screen is displayed. Only the screens for which the display history screen attribute has been set in advance are processed by this function.

The record data can be displayed, and printed out at a printer connected to the NT631/NT631C by operation from the System Menu.

This section explains how to display and print out the display history record data recorded in the NT631/NT631C.

Note that there are two display methods sort by occurrence (display time order) and sort by frequency (order of number of times displayed).

- Reference:**
- With the NT631/NT631C, the record data can also be displayed by calling screen No. 9001 (sort by occurrence) or screen No. 9002 (sort by frequency) during the RUN mode.
  - For details on the display history record function, refer to 2-15-1 Display History Record Function in the Reference Manual.
  - The order of display for sort by occurrence display (from oldest record or from newest record) is set with the Hist. Disp. Method memory switch (page 175).
  - The printing method and other information must be set in advance with the Printer Controller (page 168) and Print Method (page 169) memory switches.

Display and print the display history record data by following the menu operation from the System Menu shown below.

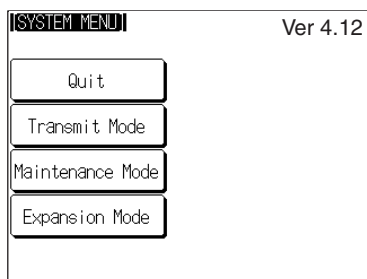

Select Maintenance Mode.

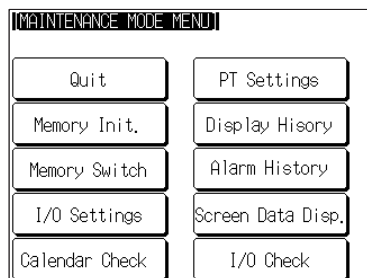

Select Display History.

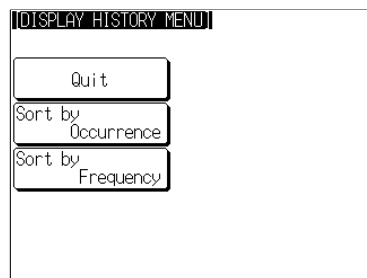

Select Sort by Occurrence or Sort by Frequency.



| No. | Scrn | YMDD | HHMM | Comment         | 1/ 1         |
|-----|------|------|------|-----------------|--------------|
| 1   | 1    | 0524 | 0441 | Start           |              |
| 2   | 32   | 0524 | 0806 | Temp. Setting 1 | Quit         |
| 3   | 44   | 0524 | 0841 | Sector A        |              |
| 4   | 32   | 0524 | 0841 | Temp. Setting 1 | ↑            |
| 5   | 33   | 0524 | 0841 | Temp. Setting 2 |              |
| 6   | 34   | 0524 | 0841 | Temp. Setting 3 | ↓            |
| 7   | 2    | 0524 | 0844 | Main Monitor    |              |
| 8   | 44   | 0608 | 0851 | Sector A        |              |
| 10  | 102  | 0612 | 1358 | [A] Low Level   |              |
| 11  | 2    | 0612 | 1403 | Main Monitor    | Prt.         |
| 12  | 45   | 0614 | 0851 | Sector B        | Prt.<br>Stop |

If necessary, select the next or previous screen by pressing [↓] (next screen) or [↑] (previous screen).

The example screen to the left shows a display for the sort by occurrence method (from oldest record).

↓

| No. | Scrn | YMDD | HHMM | Comment         | 1/ 1         |
|-----|------|------|------|-----------------|--------------|
| 1   | 1    | 0524 | 0441 | Start           |              |
| 2   | 32   | 0524 | 0806 | Temp. Setting 1 | Quit         |
| 3   | 44   | 0524 | 0841 | Sector A        |              |
| 4   | 32   | 0524 | 0841 | Temp. Setting 1 | ↑            |
| 5   | 33   | 0524 | 0841 | Temp. Setting 2 |              |
| 6   | 34   | 0524 | 0841 | Temp. Setting 3 | ↓            |
| 7   | 2    | 0524 | 0844 | Main Monitor    |              |
| 8   | 44   | 0608 | 0851 | Sector A        |              |
| 10  | 102  | 0612 | 1358 | [A] Low Level   |              |
| 11  | 2    | 0612 | 1403 | Main Monitor    | Prt.         |
| 12  | 45   | 0614 | 0851 | Sector B        | Prt.<br>Stop |

If required, press **Prt.** to print the display history record data.

↓

| No. | Scrn | YMDD | HHMM | Comment         | 1/ 1         |
|-----|------|------|------|-----------------|--------------|
| 1   | 1    | 0524 | 0441 | Start           |              |
| 2   | 32   | 0524 | 0806 | Temp. Setting 1 | Quit         |
| 3   | 44   | 0524 | 0841 | Sector A        |              |
| 4   | 32   | 0524 | 0841 | Temp. Setting 1 | ↑            |
| 5   | 33   | 0524 | 0841 | Temp. Setting 2 |              |
| 6   | 34   | 0524 | 0841 | Temp. Setting 3 | ↓            |
| 7   | 2    | 0524 | 0844 | Main Monitor    |              |
| 8   | 44   | 0608 | 0851 | Sector A        |              |
| 10  | 102  | 0612 | 1358 | [A] Low Level   |              |
| 11  | 2    | 0612 | 1403 | Main Monitor    | Prt.         |
| 12  | 45   | 0614 | 0851 | Sector B        | Prt.<br>Stop |

Press **Quit**.

The NT631/NT631C returns to the **DISPLAY HISTORY MENU** screen.

**Example Print-out**

All of the recorded data is printed out in the same order as on the currently displayed screen.

**Example:**

Sort by occurrence, from oldest record

| No. | Scrn | YY/MM/DD | HH:MM | Comment          | 01/01 |
|-----|------|----------|-------|------------------|-------|
| 1   | 1    | 98/01/12 | 10:21 | Coolant Error    |       |
| 2   | 2    | 98/01/12 | 11:53 | Motor Error      |       |
| 3   | 8    | 98/01/13 | 09:35 | Compressor Error |       |
| 4   | 2000 | 98/01/13 | 14:22 | Emergency Stop   |       |

**6-11-5 Displaying and Printing the Alarm History Record**

The alarm history record function is a function that continually monitors, during operation, the status of bits at the host designated in advance with a bit memory table, and records the time when these bits come ON, and the number of times they come ON.

The record data can be displayed, and printed out at a printer connected to the NT631/NT631C by operation from the System Menu.

This section explains how to display and print out the alarm history record data recorded in the NT631/NT631C.

Note that there are two display methods sort by occurrence (ON time order) and sort by frequency (order of number of times the bits have come ON).

- Reference:**
- With the NT631/NT631C, the record data can also be displayed by registering an alarm history display element on the screen.
  - For details on the alarm history record function, refer to *3-8 Using the Alarm List/History Function of NT31, NT31C, NT631, and NT631C Reference Manual (V064)*.
  - The order of display for sort by occurrence display (from oldest record or from newest record) is set with the Hist. Disp. Method memory switch (page 175).
  - The printing method and other information must be set in advance with the Printer Controller (page 168) and Print Method (page 169) memory switches.

Display and print the alarm history record data by following the menu operation from the System Menu shown below.

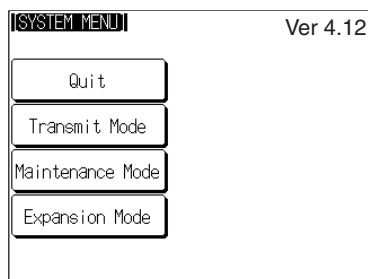

Select Maintenance Mode.

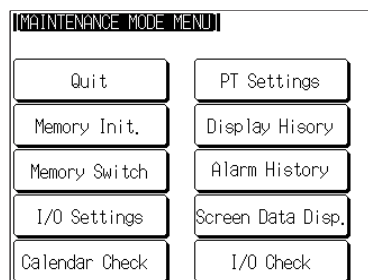

Select Alarm History.

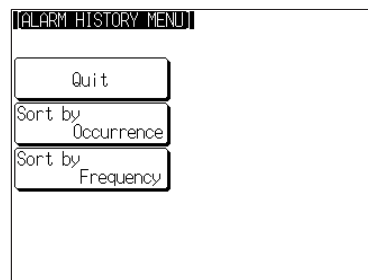

Select Sort by Occurrence or Sort by Frequency.



| No. | MMDD | HHMM | Comment           | 1/1  |
|-----|------|------|-------------------|------|
| 1   | 0524 | 0441 | Conveyor Stopped  | Quit |
| 2   | 0524 | 0806 | Temp. Low Level   | ↑    |
| 3   | 0524 | 0841 | Process 2 Stopped | ↓    |
| 4   | 0524 | 0841 | Process 1 Stopped | Prt. |
| 5   | 0524 | 0849 | Conveyor Stopped  | Prt. |
| 6   | 0524 | 1521 | Conveyor Stopped  | Stop |
| 7   | 0526 | 0844 | P/S Low Voltage   |      |
| 8   | 0527 | 1732 | Conveyor Stopped  |      |
| 9   | 0527 | 1125 | Temp. Low Level   |      |
| 10  | 0530 | 2109 | Process 1 Stopped |      |
| 11  | 0604 | 1833 | Process 1 Stopped |      |
| 12  | 0604 | 2106 | Conveyor Stopped  |      |
| 13  | 0604 | 2152 | Conveyor Stopped  |      |

If necessary, select the next or previous screen by pressing [↓] (next screen) or [↑] (previous screen).

The example screen to the left shows a display for the sort by occurrence method (from oldest record).



| No. | MMDD | HHMM | Comment           | 1/1  |
|-----|------|------|-------------------|------|
| 1   | 0524 | 0441 | Conveyor Stopped  | Quit |
| 2   | 0524 | 0806 | Temp. Low Level   | ↑    |
| 3   | 0524 | 0841 | Process 2 Stopped | ↓    |
| 4   | 0524 | 0841 | Process 1 Stopped | Prt. |
| 5   | 0524 | 0849 | Conveyor Stopped  | Prt. |
| 6   | 0524 | 1521 | Conveyor Stopped  | Stop |
| 7   | 0526 | 0844 | P/S Low Voltage   |      |
| 8   | 0527 | 1732 | Conveyor Stopped  |      |
| 9   | 0527 | 1125 | Temp. Low Level   |      |
| 10  | 0530 | 2109 | Process 1 Stopped |      |
| 11  | 0604 | 1833 | Process 1 Stopped |      |
| 12  | 0604 | 2106 | Conveyor Stopped  |      |
| 13  | 0604 | 2152 | Conveyor Stopped  |      |

If required, press Prt. to print the display history record data.



| No. | MMDD | HHMM | Comment           | 1/1  |
|-----|------|------|-------------------|------|
| 1   | 0524 | 0441 | Conveyor Stopped  | Quit |
| 2   | 0524 | 0806 | Temp. Low Level   | ↑    |
| 3   | 0524 | 0841 | Process 2 Stopped | ↓    |
| 4   | 0524 | 0841 | Process 1 Stopped | Prt. |
| 5   | 0524 | 0849 | Conveyor Stopped  | Prt. |
| 6   | 0524 | 1521 | Conveyor Stopped  | Stop |
| 7   | 0526 | 0844 | P/S Low Voltage   |      |
| 8   | 0527 | 1732 | Conveyor Stopped  |      |
| 9   | 0527 | 1125 | Temp. Low Level   |      |
| 10  | 0530 | 2109 | Process 1 Stopped |      |
| 11  | 0604 | 1833 | Process 1 Stopped |      |
| 12  | 0604 | 2106 | Conveyor Stopped  |      |
| 13  | 0604 | 2152 | Conveyor Stopped  |      |

Press Quit.  
The NT631/NT631C returns to the ALARM HISTORY MENU screen.

**Example Print-out**

All of the recorded data is printed out in the same order as on the currently displayed screen.

**Example:**

Sort by occurrence method, from oldest record

| No. | Comment          | YY/MM/DD | HH:MM | 01/01 |
|-----|------------------|----------|-------|-------|
| 1   | Remote I/O Error | 98/02/06 | 16:02 |       |
| 2   | PIC Unit Error   | 98/02/07 | 09:21 |       |
| 3   | Cycle Time Over  | 98/02/17 | 15:44 |       |

**6-11-6 Checking Screen Data**

The NT631/NT631C allows the registered screens (Nos. 1 to 3999) to be displayed and checked by operation from the System Menu.

- Reference:**
- Window screens cannot be displayed by operation from the System Menu.
  - Only the user screens (Nos. 1 to 3999) can be displayed. Screens for system use cannot be displayed.



**Specifying The Display Method**

Specify the display method for the screens as indicated in the table below.

| Setting Item                     | Function   | Setting Options |
|----------------------------------|--|-----------------|
| Display of Lamp/<br>Touch SW No. | Allows designation of whether the bit number of the lamp bit set for a lamp or touch switch is displayed or not.<br>The display format is as follows L□○○○○○○○○ (□: area type, ○○○○○○○○: bit number).  | ON, OFF*        |
| Display of Memory<br>Table No.   | Allows designation of whether the table numbers of numeral and character string memory tables are displayed or not.<br>The display format for numeral memory tables is N○○○○○ and the display format for character string memory tables is S○○○○○.<br>This function is valid for the following display elements.<br>- Numeral displays<br>- Character string displays<br>- Bar graphs<br>- Numeral setting input fields (including thumbwheel type)<br>- Character string input fields | ON, OFF*        |
| Display of image/<br>Library No. | Allows designation of whether image/library code numbers are displayed or not.   | ON, OFF*        |
| Display of Broken<br>Line Frame  | Allows designation of whether or not broken line frames are displayed around the display elements for showing the positions registered.  | ON, OFF*        |

\* Default (factory) setting

**Reference:** Each setting of the screen data check is effective only on this menu. Exiting from this screen data check menu resets the settings to the default (all the settings are set to OFF).

**Operations On The SCREEN DATA CHECK Screen**

The function shown below can be set on the SCREEN DATA CHECK screen. Use this function as required when displaying complex screens on which multiple display elements have been registered overlapping each other.

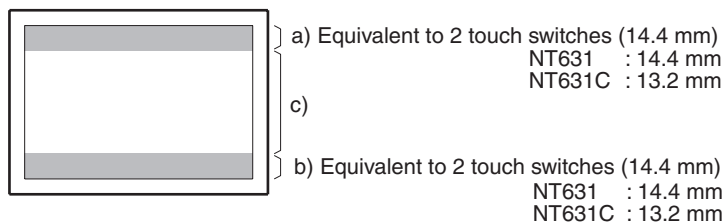

- a. Display the previous display element on the upper most portion of the screen in the order in which the display elements were registered (excluding fixed display elements).
- b. Display the next display element on the upper most portion of the screen in the order in which the display elements were registered (excluding fixed display elements).
- c. Return to the screen on which screens are specified.

**Displaying the SCREEN DATA CHECK Screen**

Display the SCREEN DATA CHECK screen by following the menu operation from the System Menu shown below.

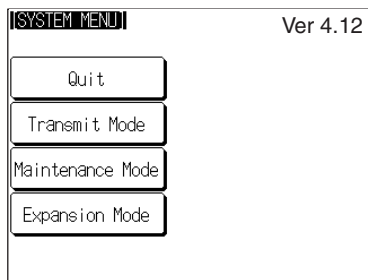

Select Maintenance Mode.

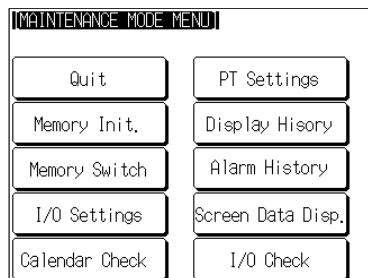

Select Screen Data Disp.

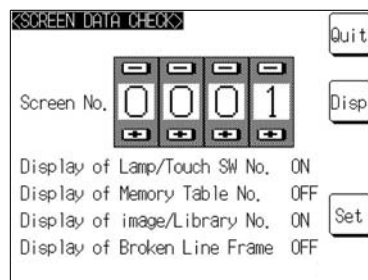

Specify the screen to be displayed in the input field in the middle of the screen.

Each of the digits can be incremented or decremented by pressing the associated + and - keys.

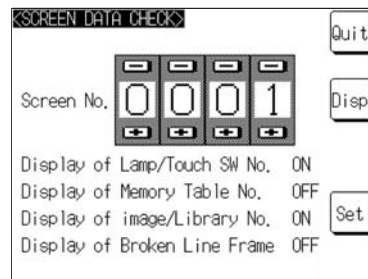

Press Set.

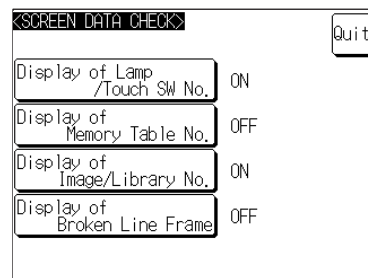

Press the touch switches to specify the display method in each case.

The setting option changes each time a touch switch is pressed.



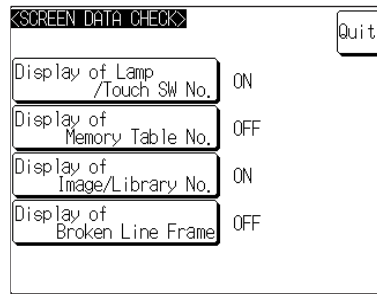

Press Quit to return to the screen number selection screen.

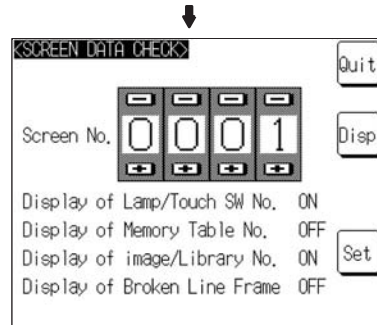

Press Disp.

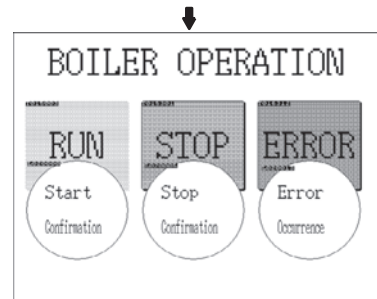

Touching the top or bottom of the screen changes the way the display elements overlap each other in the order in which they are registered.

In this example, the bottom portion of the touch switch, which is under the lamp, will be displayed over the lamp.

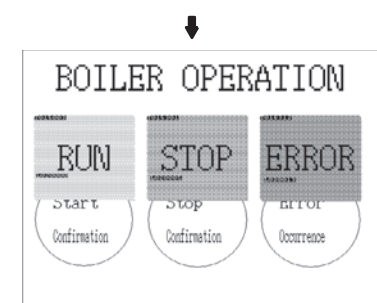

When you have finished checking the screen, press the central part of the screen to return to the screen number selection screen.

If you wish to continue by checking another screen, repeat the operation, starting by specifying the screen number.

To end the operation, press Quit on the screen number selection screen. The NT631/NT631C returns to the MAINTENANCE MODE MENU screen.

### 6-11-7 Device Check

The NT631/NT631C provides checks on the functions of the following items.

- Buzzer page 202
- LED page 203
- LCD page 204
- Backlight page 204
- Screen data memory page 205
- Touch switches page 207
- Battery voltage page 208

**Checking the Buzzer**

Check if the buzzer sounds correctly.

**Reference:** The buzzer will sound in this check regardless of the setting made with the Buzzer Sound memory switch.

Check the buzzer by following the menu operation from the System Menu shown below.

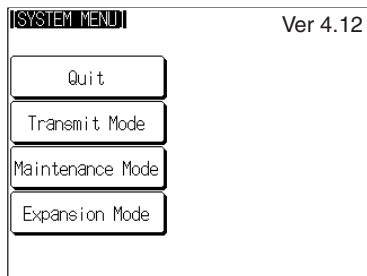

Select Maintenance Mode.

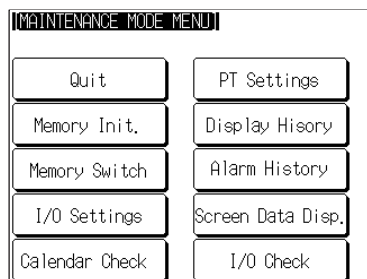

Select I/O Check.

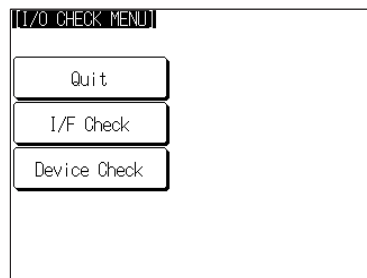

Select Device Check.

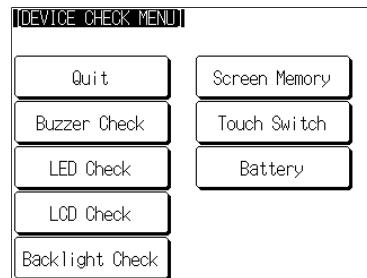

Select Buzzer Check.

- If the buzzer functions correctly, it will sound continuously. At this time, the Buzzer Check touch switch will be displayed in reverse video.
- To stop the buzzer while it is sounding, press the Buzzer Check touch switch again.

**Checking the RUN LED**

Check if the RUN LED functions normally.

Check the RUN LED by following the menu operation from the System Menu shown below.

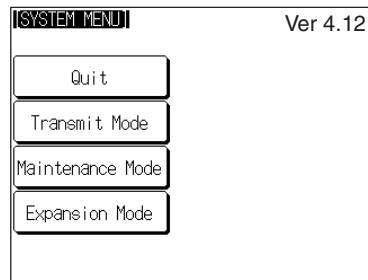

Select Maintenance Mode.

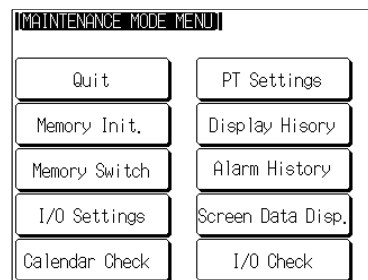

Select I/O Check.

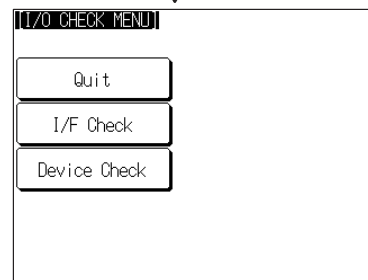

Select Device Check.

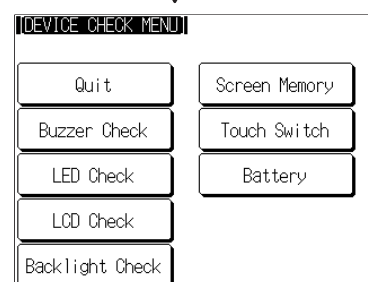

Select LED Check.

- If the RUN LED is functioning normally, it will operate as follows. At this time the LED Check touch switch will be displayed in reverse video.  
Lit in green - OFF - lit in red - OFF - lit in green...
- To end the LED check, press the LED Check touch switch on the DEVICE CHECK MENU screen again.

**Checking the LCD (Screen Display)**

Check if the LCD display (or EL display for NT631) functions normally by following the menu operation from the System Menu shown below.

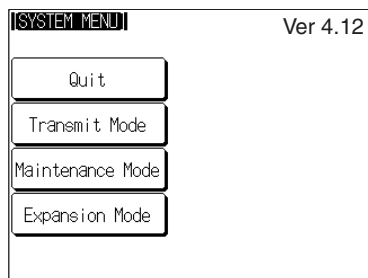

Select Maintenance Mode.

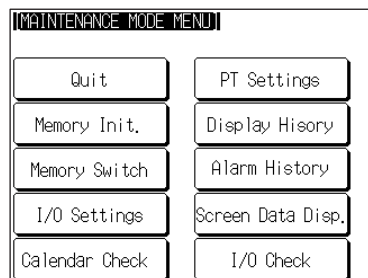

Select I/O Check.

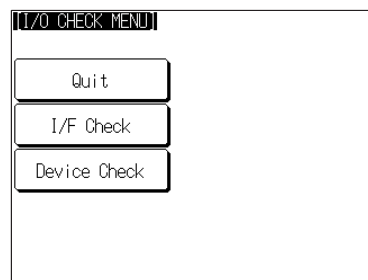

Select Device Check.

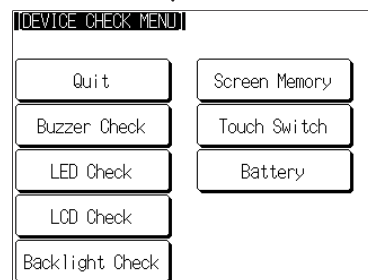

Select LCD Check.

- The check screen displays all the dots on the screen: either press anywhere on the touch panel or wait for three seconds and all the dots will be cleared.

With the NT631C, the display and clearance of all the dots on the screen is repeated for each color in turn (red green blue magenta cyan yellow white black).

On completion of the display and clearance of all dots, the NT631/NT631C returns to the DEVICE CHECK MENU screen.

- Touch the touch panel to discontinue the LCD check. Even if 3 seconds have not passed, the check will proceed to the next color.

**Checking the Backlight (for NT631C only)**

Check if the backlight functions normally with the NT631C by following the menu operation from the System Menu shown below. This function is not available with the NT631.

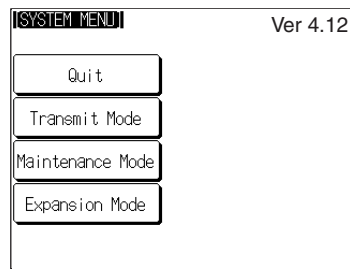

Select Maintenance Mode.

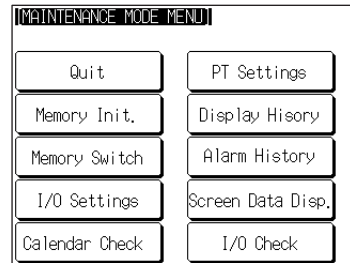

Select I/O Check.

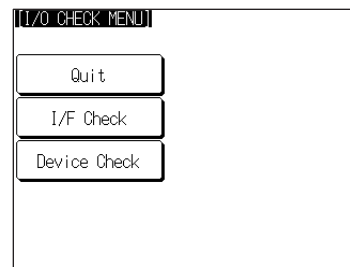

Select Device Check.

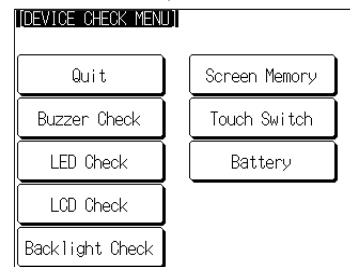

Select Backlight Check.

- If the backlight is normal, it flashes. At this time, the Backlight Check touch switch is displayed in reverse video.
- To end the backlight check, press the Backlight Check touch switch again.

**Screen Data Memory Check**

Check if the screen data memory is functioning normally.

**Reference:**

- In the screen data memory check, a write test is performed on the screen data memory. Since all the screen data in the NT631/NT631C is lost in this check, confirm that this data is backed up at the Support Tool or Memory Unit before executing it.
- If writing to the screen data memory is disabled by the setting for System Settings in the System Installer mode, it is not possible to execute a screen data check.
- Once a screen data check has been started, it cannot be stopped.

Check the screen data memory by following the menu operation from the System Menu shown below.

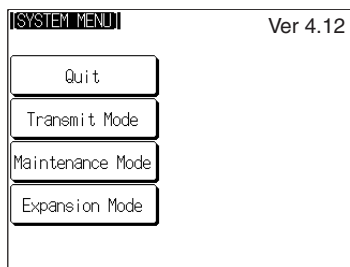

Select Maintenance Mode.

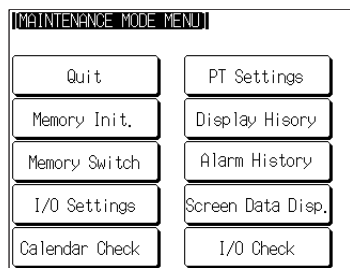

Select I/O Check.

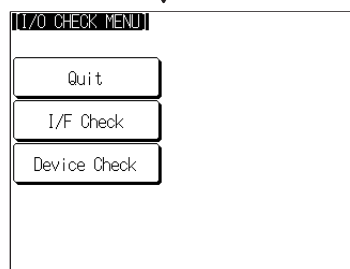

Select Device Check.

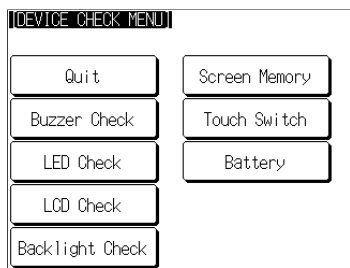

Select Screen Memory.

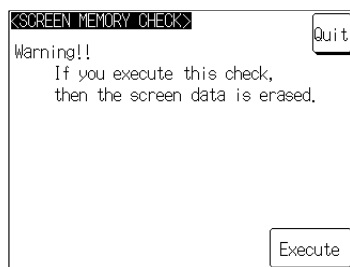

Press Execute.

- During the check, the message Checking Now... is displayed.
- On normal completion of the check, the message Memory Check OK is displayed.
- If an error is discovered in the check, the message Memory Check NG is displayed.



After confirming the result of the check, press Quit. The NT631/NT631C returns to the DEVICE CHECK MENU screen.

**Checking Touch Switches**

Check whether or not the touch switches function normally by following the menu operation from the System Menu shown below.

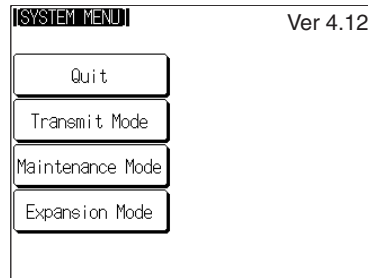

Select Maintenance Mode.

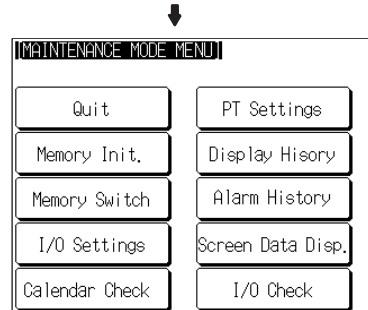

Select I/O Check.

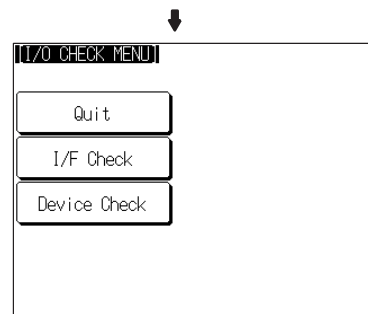

Select Device Check.

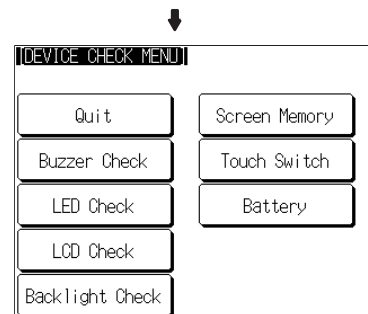

Select Touch Switch.

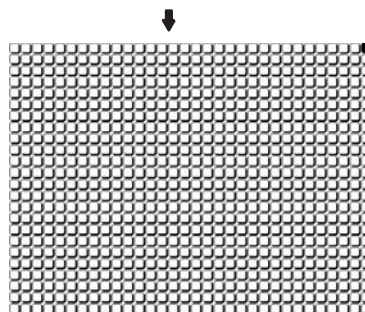

Press the touch switches displayed on the screen. A touch switch is normal if it is displayed in reverse video while pressed.

To end the check, press the touch switch at the top right corner (NT631: displayed in reverse video; NT631C: displayed in yellow). The NT631/NT631C will return to the DEVICE CHECK MENU.

- Reference:**
- The host is not notified of the operation of touch switches pressed during the I/O check.
  - The check cannot be performed until the touch switch at the top right corner is displayed in reverse video (for NT631) or displayed in yellow (NT631C). Start the check after the status of the touch switch at the top right corner has changed.

### Checking the Battery Voltage

Check the voltage of the NT631/NT631C's built-in battery by following the menu operation from the System Menu shown below.

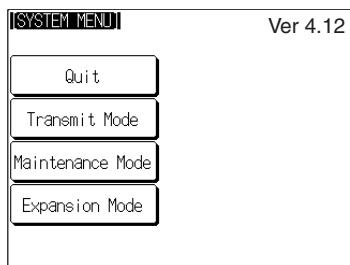

Select Maintenance Mode.

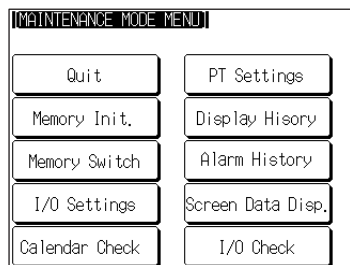

Select I/O Check.

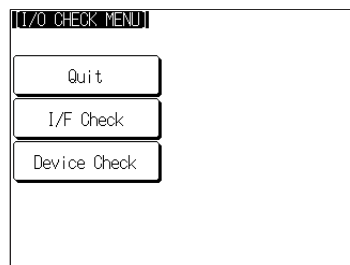

Select Device Check.

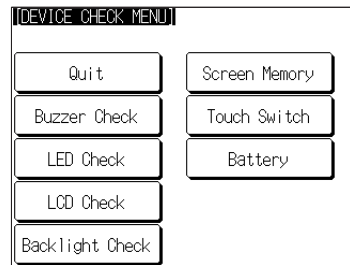

Select Battery.



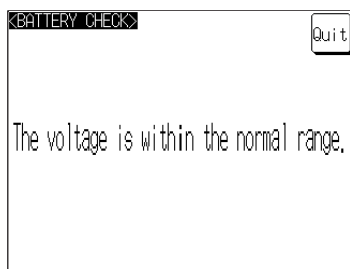

The voltage is within the normal range. or  
The voltage is lowered. is displayed.

After confirming the result of the check, press Quit. The NT631/NT631C returns to the DEVICE CHECK MENU screen.

**Note** When The voltage is lowered is displayed, replace the built-in battery immediately. For details on the replacement method, refer to 7-3-1 Replacing the Battery (page 241).

### 6-11-8 Checking Interfaces

The NT631/NT631C allows the following communications functions to be checked.

- Communications with the Support Tool page 209
- Communications at serial ports page 210
- Communications with printers page 213

#### Checking Communications with the Support Tool

Check communications with the Support Tool by following the menu operation from the System Menu shown below.

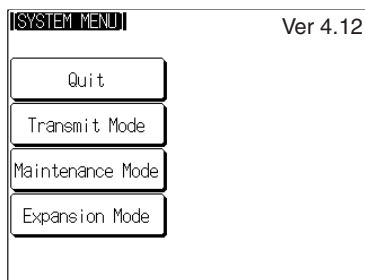

Select Maintenance Mode.

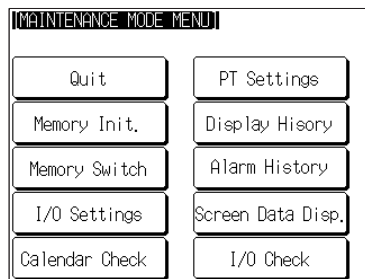

Select I/O Check.

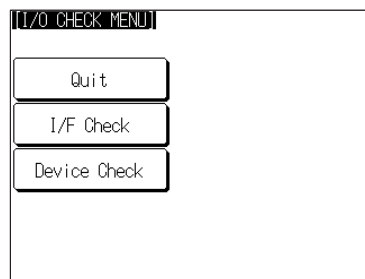

Select I/F Check.





**For NT Link (1:1, 1:N Standard, or 1:N High-speed)**

**Example:** Serial port B while using the NT Link (1:N)

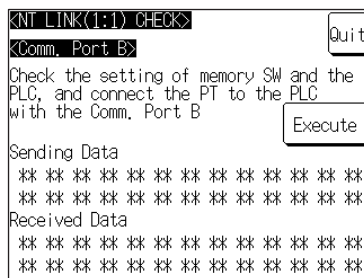

Press Execute to start the check. The data for checking communications is sent to the host, and is displayed as \*\* symbols at Sending Data.

- If communications with the host are normal, the reply from the host is displayed at Received Data as \*\* symbols.
- If a communications error occurs while checking the communications conditions with the host, a communications error screen is displayed. Since this indicates that there is a communications fault, check the communications cables and settings.

**For Memory Link**

**Example:** Serial port A while using the memory link

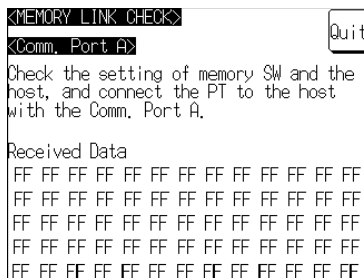

The check is started as soon as the check screen is displayed. Send the command from the host.

- If communications with the host are normal, the data received from the host is displayed in hexadecimal text code at Received Data.
- If nothing is displayed at Received Data when the command is sent from the host, there is a communications fault: check the communications cables and settings.

**For a Bar Code Reader**

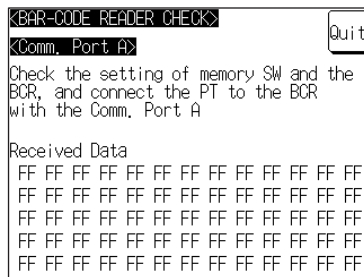

The check starts when the check screen is displayed. Read data with the bar code reader in this status.

- If communications with the bar code reader are normal, the read character strings are displayed in hexadecimal text code at Received Data.

- If nothing is displayed at Received Data when data is read with the bar code reader, there is a communications fault: check the communications cables and settings.

**Check Method**

Check communications with the serial ports by following the menu operation from the System Menu shown below.

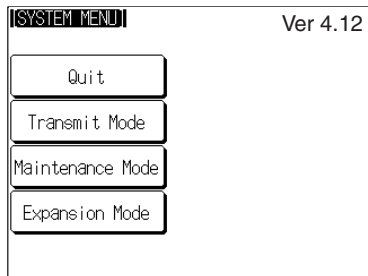

Select Maintenance Mode.

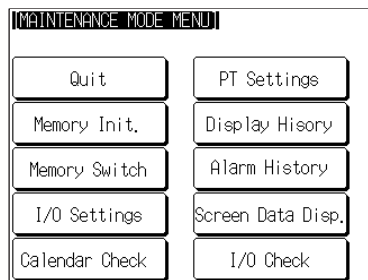

Select I/O Check.

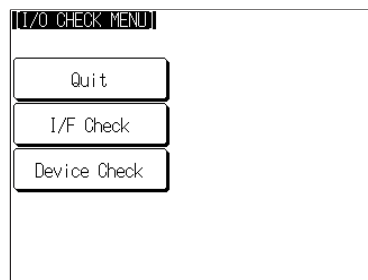

Select I/F Check.

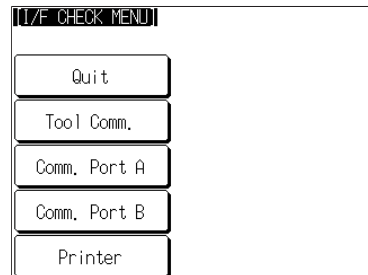

Select Comm. Port A or Comm. Port B. The check screen is displayed (Check screen, page 210).

After confirming the result of the check, press Quit. The NT631/NT631C returns to the I/F CHECK MENU screen.

**Checking Communications with a Printer**

Check communications with a printer by following the menu operation from the System Menu shown below.

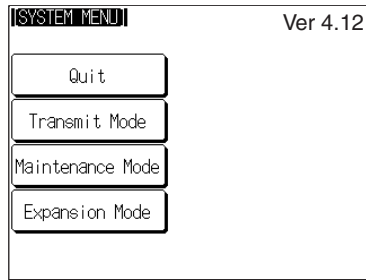

Select Maintenance Mode.

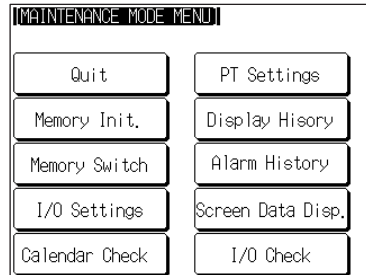

Select I/O Check.

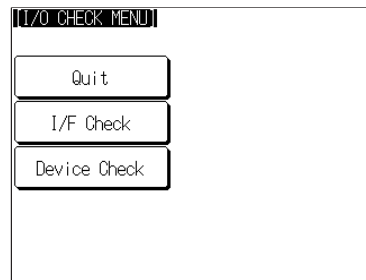

Select I/F Check.

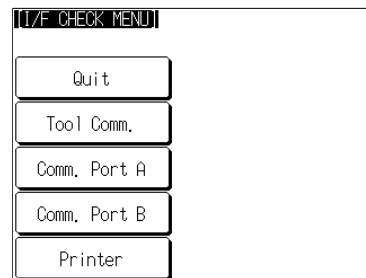

Select Printer.

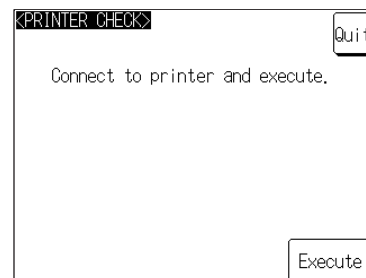

Confirm that a printer is connected to the NT631/NT631C, then press Execute: Printer Interface Check will be printed out at the printer.

- While data is being sent to the printer, the message Checking Now... is displayed.
- When the sending of data to the printer is completed, Finished Normal by Printer Interface Check is displayed.

- If data does not reach the printer within 60 seconds after sending starts, the message 'Finished Printer output failed' is displayed.

After confirming the result of the check, press Quit. The NT631/NT631C returns to the I/F CHECK MENU screen.

## 6-12 Programming Console Function

The NT631/NT631C has been equipped with the Programming Console function, which allows it to be used like a C200H-PRO27-E Programming Console for CPM1, CPM2A, CPM2C, CQM1, CQM1H, C200HX/HG/HE(-Z)E, CS/CJ-series PLC, or SRM1 PLCs.

Except for recording (saving) ladder programs on cassette tape and replaying (reading) them, almost all the functions of a Programming Console can be executed.

**Note** When the programmable controller functions are used, carefully check that the system is safe before carrying out the following operations.

- Changing monitor data
- Switching the operating mode
- Forced set or reset
- Changing a present value or set value



### 6-12-1 Usable Systems

The Programming Console function can be used with an NT631/NT631C connected to a PLC when using the communications method indicated below.

| Communications Method | Applicable PLCs   | Connected Port  |
|-----------------------|---|---|
| NT Link (1:1)         | C200HE-CPU42-(Z)E <sup>(*1)</sup><br>C200HG-CPU43/63-(Z)E <sup>(*1)</sup><br>C200HX-CPU44/64-(Z)E <sup>(*1)</sup><br>C200HX-CPU65-ZE <sup>(*1)</sup><br>C200HX-CPU85-ZE <sup>(*1)</sup><br>CPM2A-30CD□□-□ <sup>(*1)</sup><br>CPM2A-40CD□□-□ <sup>(*1)</sup><br>CPM2A-60CD□□-□ <sup>(*1)</sup><br>CPM2C-10□□□□□□-□ <sup>(*2)</sup><br>CPM2C-20□□□□□□-□ <sup>(*2)</sup><br>CQM1-CPU4□-EV1 <sup>(*1)</sup><br>CQM1H-CPU21/51/61 <sup>(*1)</sup><br>SRM1-C02-V2 | CPU Unit's built-in RS-232C port                                    |
|                       | CPM1-10CDR-□<br>CPM1-20CDR-□<br>CPM1A-10CD□-□<br>CPM1A-20CD□-□<br>CPM1A-30CD□-□<br>CPM1A-40CD□-□  | Peripheral port <sup>(*3)</sup>                                     |
| NT Link (1:N)         | CS1G-CPU42/43/44/45-EV1<br>CS1H-CPU63/64/65/66/67-EV1<br>CS1G-CPU42H/43H/44H/45H<br>CS1H-CPU63H/64H/65H/66H/67H<br>CS1D-CPU66H/67H<br>CJ1G-CPU44/45<br>CJ1G-CPU42H/43H/44H/45H<br>CJ1H-CPU65H/66H/67H<br>CJ1M-CPU11/12/13/21/22/23  | CPU Unit's built-in RS-232C port<br>Peripheral port <sup>(*4)</sup> |

<sup>\*1</sup> The peripheral port Programming Console always has priority. If a Programming Console is connected later, the Programming Console function of the NT631/NT631C is invalidated and operation from the NT631/NT631C becomes impossible.

<sup>\*2</sup> The CPM2C-CN111 Connecting Cable splits the PLC's Communications Port into a RS-232C port and a peripheral port.

<sup>\*3</sup> An RS-232C cable cannot be connected to the peripheral port. An RS-232C adapter (CPM1-CIF01) is required.

<sup>\*4</sup> The RS-232C cable cannot be directly connected to the peripheral port. An RS-232C converting cable (CS1W-CN118) is required.

**Reference:** Note that the Programming Console function cannot be used with CPM1, CQM1, and C200HX/HG/HE(-Z)E PLCs of the following lot numbers.

CPM1: □□□5, □□\*6

where \* is a number in the range 1 to 9 or the letter X or Y.

CQM1: □□□3, □□□4, □□□5, □□\*6

where \* is a number in the range 1 to 9 or the letter X or Y.

C200HX/HG/HE: □□□5 □□\*6

where \* is a number in the range 1 to 9 or the letter X or Y.

## 6-12-2 Connection Method

### CQM1, CQM1H, C200HX/ HG/HE(-Z)E, or SRM1

The connection method is exactly the same as for the NT Link (1:1). Refer to *SECTION 4 Connecting to the Host from the RS-232C Port* or *SECTION 5 Connecting to the Host from the RS-422A/485 Port* for details on connecting to the PLC.

\* When using the Programming Console function with a CQM1H, turn ON pin 7 of the DIP switch on the front of the CQM1H's CPU Unit.

### CPM1 or CPM2A

The connection method is the same as for the NT Link (1:1). With a CPM1, connect the RS-232C cable to the peripheral port via a CPM1-CIF01 RS-232C Adapter or CPM1-CIF11 RS-422A Adapter.

Refer to *SECTION 4 Connecting to the Host from the RS-232C Port* or *SECTION 5 Connecting to the Host from the RS-422A/485 Port* for details on connecting to the PLC.

### CPM2C

The connection method is the same as for the NT Link (1:1). Connect to the PLC's communications connector with a CPM2C-CN111 or CS1W-CN114/118 Connecting Cable, a CPM1-CIF01 RS-232C Adapter, or a CPM1-CIF11 RS-422A Adapter.

Refer to *SECTION 4 Connecting to the Host from the RS-232C Port* or *SECTION 5 Connecting to the Host from the RS-422A/485 Port* for details on connecting to the PLC.

\* When using the Programming Console function with a CPM2C, turn ON pin 2 of the DIP switch on the front of the CPM2C's CPU Unit.

### CS/CJ-series PLC

The connection method is exactly the same as for the NT Link (1:N) (standard or high-speed). Refer to *SECTION 4 Connecting to the Host from the RS-232C Port* or *SECTION 5 Connecting to the Host from the RS-422A/485 Port* for details on connecting to the PLC. The standard or high-speed 1:N NT Link can be used.

The Programming Console function can be used only when the PT's unit number is set to 0. Only one Unit using the Programming Console function can be connected to each of the PLC's ports (built-in RS-232C port and peripheral port).

Make sure that the PT's highest unit number is set to 0 in the CS/CJ-series PLC setup.

With the CS/CJ-series PLC, the Programming Console function can not be used simultaneously at both the built-in RS-232C port and peripheral port. Furthermore, the Programming Console function can not be started at the RS-232C port while a Programming Console is connected to the peripheral port.

### 6-12-3 Method of Use

The Programming Console screen is displayed by operating the system menu as described below.

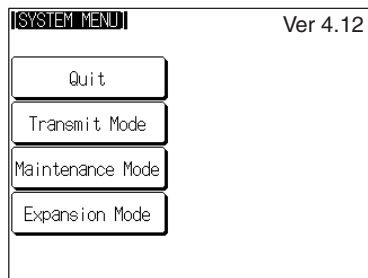

Select Expansion Mode.

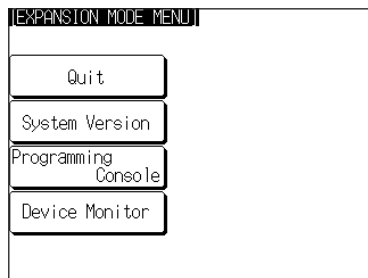

Select Programming Console.

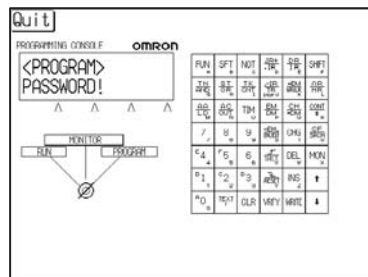

The Programming Console screen is displayed.

Press the Programming Console sheet keys (touch switches) for the operation.

Press the Quit touch switch to exit the screen.

An error is displayed if a wrong communications protocol is selected or a Programming Console is connected to the peripheral port. (\*1)

\*1 With the CS1G/CS1H, the Programming Console function can not be used simultaneously at both the built-in RS-232C port and peripheral port.

**Reference:** If an error screen is displayed, the System Menu can be displayed from the error screen by pressing two of the four corners of the touch panel simultaneously. Pressing the OK touch switch on the error screen will return the display to that immediately before the error occurred, but only if the cause of the error is removed. If this does not happen, press two of the four corners of the touch panel to display the System Menu.

#### Key Operations

##### Mode Selection Keys, Mode Lock Key

The display element on the Programming Console screen shown below comprises the mode selection keys, which change the operation mode of the PLC, and the mode lock key, which prevents unintended mode changes.

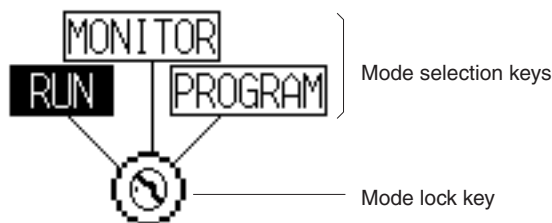

The RUN, MONITOR, and PROGRAM mode selection key elements are touch switches and pressing them causes the PLC operation mode to change (unlike an actual Programming Console, it is possible to switch directly between the RUN mode and the PROGRAM mode.)

When the Programming Console function is started, the PLC operation status is read and reflected at the PLC.

The mode lock key element is also a touch switch, and it alternates between the lock ON (with no key displayed) and lock OFF (with key displayed) states when pressed. During the lock ON state, mode selection key operations are ineffective. The mode displays change as indicated in the figures below during the lock ON status and during the lock OFF status.

When the Programming Console function starts, the lock ON status is established.

If the RUN, MONITOR, or PROGRAM mode selection key is pressed in the lock OFF status, the mode changes and the lock ON status is established.

**During Lock OFF**

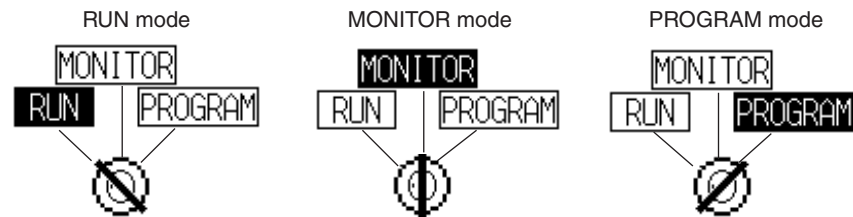

**During Lock ON**

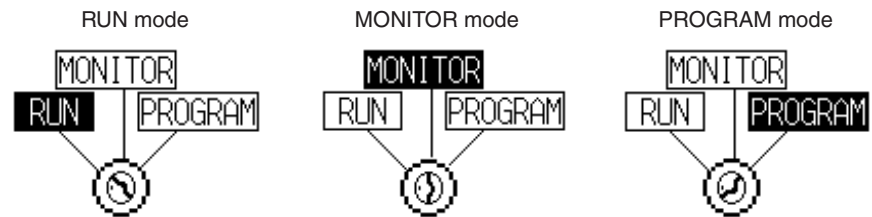

**Programming Console Keyboard**

The Programming Console keyboard used on the screen when the Programming Console function is used is comprised entirely of touch switches (shown by the dashed line frames in the figure below). On pressing a touch switch, a key operation is executed. However, since there is a discrepancy between the size of the displayed keys and the size of the touch switches, take care to press as close to the center of the key as possible by referring to the figure below.

In addition, if the connected host is the CS1G/CS1H, the Programming Console key sheet for the CS-series is automatically displayed.

Standard Programming Console Key Sheet

|                                       |  |                     |          |     |              |           |           |
|---------------------------------------|--|---------------------|----------|-----|--------------|-----------|-----------|
| Quit                                  |  | PROGRAMMING CONSOLE |          |     |              |           | OMRON     |
| <PROGRAM><br>PASSWORD<br>△ △ △ △      |  | FUN                 | SET      | NOT | SHIFT        |           |           |
|                                       |  | AND<br>+            | OR<br>#  | CNT | TR           | *EM<br>LR | AR<br>HR  |
| △ △ △ △<br>MONITOR<br>RUN PROGRAM<br> |  | LD<br>H             | OUT<br>- | TIM | EM<br>DM     | CH<br>*DM | CONT<br># |
|                                       |  | 7                   | 8        | 9   | EXT          | CHG       | SRCH      |
| △ △ △ △<br>MONITOR<br>RUN PROGRAM<br> |  | E 4                 | F 5      | 6   | PLAY<br>SET  | DEL       | MONTR     |
|                                       |  | B 1                 | C 2      | D 3 | REC<br>RESET | INS       | ↑         |
| △ △ △ △<br>MONITOR<br>RUN PROGRAM<br> |  | A 0                 |          | CLR | VER          | WRITE     | ↓         |

Programming Console Key Sheet for CS1 Series

|                                       |  |                     |           |           |               |              |            |
|---------------------------------------|--|---------------------|-----------|-----------|---------------|--------------|------------|
| Quit                                  |  | PROGRAMMING CONSOLE |           |           |               |              | OMRON      |
| <PROGRAM><br>PASSWORD<br>△ △ △ △      |  | FUN                 | SFT       | NOT       | IR+<br>IR     | DR<br>IR     | SHIFT      |
|                                       |  | TN<br>AND           | ST<br>OR  | TK<br>CNT | -IR<br>TR     | *EM<br>WR/LR | AR<br>HR   |
| △ △ △ △<br>MONITOR<br>RUN PROGRAM<br> |  | AA<br>LD            | AC<br>OUT | TIM       | EM<br>DM      | CH<br>*DM    | CONT<br>#  |
|                                       |  | 7                   | 8         | 9         | *EM<br>EM/EXT | CHG          | CF<br>SRCH |
| △ △ △ △<br>MONITOR<br>RUN PROGRAM<br> |  | E 4                 | F 5       | 6         | SET           | DEL          | MON        |
|                                       |  | B 1                 | C 2       | D 3       | RESET         | INS          | ↑          |
| △ △ △ △<br>MONITOR<br>RUN PROGRAM<br> |  | A 0                 | TEXT      | CLR       | VERFY         | WRITE        | ↓          |

Differences with Respect to Programming Consoles

- Programs cannot be stored (recorded) or read (replayed). If it is necessary to store or read a program, use a Programming Device.
- It is not possible to adjust the volume of the key press sound. Whether or not the key press sound sounds is determined by the setting for the Key Press Sound memory switch of the NT631/NT631C. It sounds when the setting is ON and does not when the setting is OFF (page 166).
- If an error occurs when using the Programming Console function, an error screen is displayed. Whether or not the buzzer sounds at this time is determined by the setting for the Buzzer Sound memory switch of the NT631/NT631C (page 166).

**Reference:** A communications error will occur if you use the Programming Console function to change the communications settings (in the PLC Setup) that govern the port to which the NT631/NT631C is connected. In this case, the Programming Console function will be unusable.

## 6-13 Device Monitor Function

The NT31/NT31C has been equipped with the Device Monitor function which can be used to change the PLC's operating mode, read/change words in the PLC's data areas, and display the PLC's error log of a CS/CJ-series PLC, CPM1, CPM2A, CPM2C, CQM1, CQM1H, C200HX/HG/HE(-Z)E, or SRM1.

The Device Monitor can perform the following operations:

- Changing the PLC's operating mode
- Displaying/changing the contents of words, displaying/changing the status of bits, force-setting/force-resetting the status of bits (Registration Monitor)
- Listing the contents of a range of words (Continuous Monitor)
- Displaying the error log and clearing errors (Error Log)

This section provides an overview of the Device Monitor function and explains how to connect to the PLC. For more details, refer to *2-16 Device Monitor Function* in the *Reference Manual*.

 **Caution** Be sure that it is safe to proceed before using the Device Monitor function to perform one of the following operations from the PT.  
Changing monitored data  
Switching the PLC's operating mode  
Force setting or force resetting bits  
Changing PVs or SVs

**Reference:**

- The Device Monitor function can be used with Ver. 3.0 and higher versions of the PT system program only.
- The Device Monitor functions are almost identical to the functions of the Data Access Console (DAC).
- The Device Monitor function cannot be used with host link or memory link communications.

### 6-13-1 Compatible Systems

The following table shows the combinations of communications methods and PLCs that can support the PT's Device Monitor function.

| Communications method | PLC model  |
|-----------------------|--|
| 1:1 NT Link           | C200HS-CPU21/23/31/33<br>C200HE-CPU32/42 (-Z)E<br>C200HG-CPU33/43/53/63 (-Z)E<br>C200HX-CPU34/44/54/64 (-Z)E<br>C200HX-CPU65-ZE<br>C200HX-CPU85-ZE<br>CPM1-10CDR-□ <sup>*1</sup><br>CPM1-20CDR-□ <sup>*1</sup><br>CPM1A-10CD□-□ <sup>*1</sup><br>CPM1A-20CD□-□ <sup>*1</sup><br>CPM1A-30CD□-□ <sup>*1</sup><br>CPM1A-40CD□-□ <sup>*1</sup><br>CPM2A-30CD□□-□<br>CPM2A-40CD□□-□<br>CPM2A-60CD□□-□<br>CPM2C-10□□□□□□-□ <sup>*2</sup><br>CPM2C-20□□□□□□-□ <sup>*2</sup><br>CQM1-CPU4□-EV1<br>CQM1H-CPU21/51/61<br>SRM1-C02-V2 |
| 1:N NT Link           | C200HE-CPU32/42 (-Z)E<br>C200HG-CPU33/43/53/63 (-Z)E<br>C200HX-CPU34/44/54/64 (-Z)E<br>C200HX-CPU65-ZE<br>C200HX-CPU85-ZE<br>CQM1H-CPU21/51/61<br>SRM1-C02-V2<br>CS1G-CPU42/43/44/45-E(V1)<br>CS1H-CPU63/64/65/66/67-E(V1)<br>CS1G-CPU42H/43H/44H/45H<br>CS1H-CPU63H/64H/65H/66H/67H<br>CS1D-CPU65H/67H<br>CJ1G-CPU44/45<br>CJ1G-CPU42H/43H/44H/45H<br>CJ1H-CPU65H/66H/67H<br>CJ1M-CPU11/12/13/21/22/23  |

\*1 A CPM1-CIF01 RS-232C Adapter is required.

\*2 Use a Conversion Cable (CPM2C-CN111 or CS1W-CN114/118), CPM1-CIF01 RS-232C Adapter, or CPM1-CIF11 RS-422A Adapter to connect to the PLC.

### 6-13-2 Connection Method

**CQM1H or C200HX/HG/HE(-Z)E**

The 1:1 NT Link or 1:N NT Link can be used. The connection method is exactly the same as for the 1:1 NT Link or 1:N NT Link. Refer to *SECTION 4 Connecting to the Host from the RS-232C Port* or *SECTION 5 Connecting to the Host from the RS-422A/485 Port* for details on connecting to the PLC.

**CQM1 or C200HS**

The 1:1 NT Link can be used. The connection method is exactly the same as for the 1:1 NT Link. Refer to *SECTION 4 Connecting to the Host from the RS-232C Port* or *SECTION 5 Connecting to the Host from the RS-422A/485 Port* for details on connecting to the PLC.

**CPM1, CPM2A, or SRM1**

The 1:1 NT Link can be used in all CPU Units and the 1:N NT Link can also be used in -V2 and higher versions of the SRM1. The connection method is exactly the same as for the 1:1 NT Link or 1:N NT Link. With a CPM1, connect the RS-232C cable to the peripheral port via a CPM1-CIF01 RS-232C Adapter or CPM1-CIF11 RS-422A Adapter.

Refer to *SECTION 4 Connecting to the Host from the RS-232C Port* or *SECTION 5 Connecting to the Host from the RS-422A/485 Port* for details on connecting to the PLC.

**CPM2C**

The 1:1 NT Link can be used. The connection method is the same as for the NT Link (1:1). Connect to the PLC's communications connector with a CPM2C-CN111 or CS1W-CN114/118 Connecting Cable, a CPM1-CIF01 RS-232C Adapter, or a CPM1-CIF11 RS-422A Adapter.

Refer to *SECTION 4 Connecting to the Host from the RS-232C Port* or *SECTION 5 Connecting to the Host from the RS-422A/485 Port* for details on connecting to the PLC.

**CS/CJ-series PLC**

The 1:N NT Link (standard or high-speed) can be used. The connection method is exactly the same as for the 1:N NT Link.

Refer to *SECTION 4 Connecting to the Host from the RS-232C Port* or *SECTION 5 Connecting to the Host from the RS-422A/485 Port* for details on connecting to the PLC.



### 6-13-3 Method of Use

The Device Monitor screen is displayed by operating the system menu as described below.

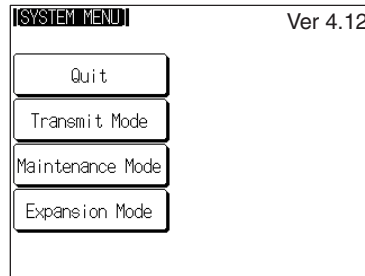

Select Expansion Mode.

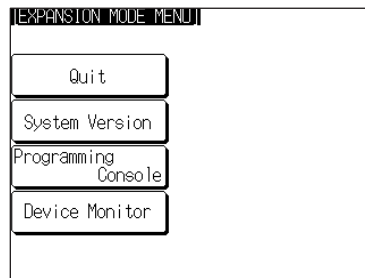

Select Device Monitor.

An error message will be displayed if the wrong communications protocol is selected.

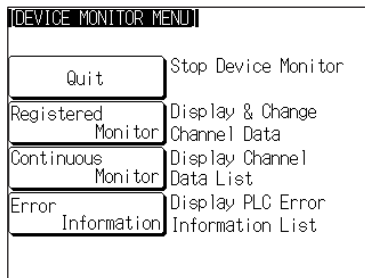

The Device Monitor screen is displayed.

**Reference:** If an error screen is displayed, the System Menu can be displayed from the error screen by pressing two of the four corners of the touch panel simultaneously. Pressing the OK touch switch on the error screen will return the display to that immediately before the error occurred, but only if the cause of the error is removed. If this does not happen, press two of the four corners of the touch panel to display the System Menu.

For more details on operations of the Device Monitor function, refer to *2-16 Device Monitor Function* in the *Reference Manual*.

## 6-14 Version Display

Use the Version Display function to check the version of the NT631/NT631C's system program. The Version Display screen shows the model, creation date, and version of the system program installed in the NT631/NT631C.

## 6-14-1 Method of Use

The Version Display screen is displayed by operating the system menu as described below.

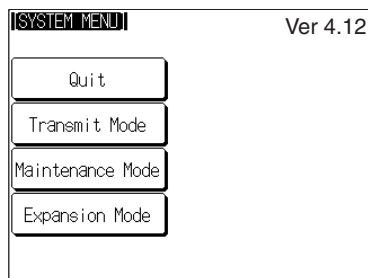

Select Expansion Mode.

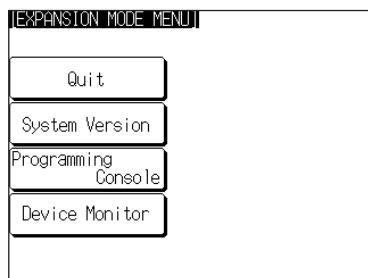

Select Version Display.

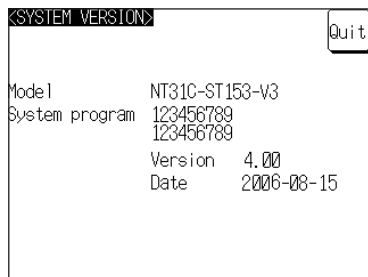

The system program's version information will be displayed as described below. Press the Quit touch switch and return to the Expansion Mode screen.

- PT Model: PT model number
- System program: System program name
- Version: System program version
- Date: Date program was created.

This screen is an example. Actual screens will show the information specific to the PT and system program being used.

After checking the version information, press the Quit touch switch to exit the Version Display screen and return to the Expansion Mode screen.

### Reference:

- The PT model always shows the model number of the ivory model of the PT. The B suffix will not be displayed, even for black models.
- The system program's version number is also displayed in the upper-right corner of the System Menu.
- The creation date does not always match the file date of the system program installed with the System Installer.

# SECTION 7

## Troubleshooting and Maintenance

This section describes the action to take when NT631/NT631C errors occur, and how to carry out maintenance and inspection to prevent the occurrence of errors.

|       |   |     |
|-------|---|-----|
| 7-1   | Troubleshooting . . . . .   | 226 |
| 7-2   | Responding to Displayed Error Messages . . . . .                          | 229 |
| 7-2-1 | Errors Occurring at Start of Operation and Their Remedies . . . . .       | 229 |
| 7-2-2 | Errors Occurring during Operation and Their Remedies . . . . .            | 231 |
| 7-2-3 | Errors Occurring on Screen Data Initialization and Transmission . . . . . | 232 |
| 7-2-4 | Errors in the System Installer Mode and Their Remedies . . . . .          | 232 |
| 7-2-5 | Communications Errors and Their Remedies . . . . .                        | 233 |
| 7-3   | Maintenance of the NT631/NT631C . . . . .                                 | 235 |
| 7-3-1 | Replacing the Battery . . . . .   | 241 |
| 7-4   | Inspection and Cleaning . . . . .   | 242 |

## 7-1 Troubleshooting

When a fault relating to the operation of the NT631/NT631C occurs, find the symptoms in the table below and respond by following the corresponding *Remedy* indicated in the table.

- Note**
1. Confirm system safety before turning the power ON/OFF or resetting.
  2. Do not disassemble the PT for repair or modification.

| NT631/NT631C Symptoms   | Cause   | Remedy   |
|---|---|--|
| Power LED fails to come ON  | Power is not being supplied.  | Check the connections and make sure that power is supplied correctly. (3-1-3 Power Supply Connection, page 33)   |
|   | Power supply fuse has blown.  | Contact your OMRON service center.   |
| Nothing is displayed on the screen.   | Screen No. 0 has been read at the host side.  | This is not an error. Change the screen number from screen number 0. (Setting the screen number to 0 turns the screen off.)  |
|   | The system startup waiting time has not elapsed yet.  | This is not an error. The display will appear after the waiting time has elapsed.  |
| Cannot communicate with the Support Tool  | The Transmit mode has not been established.   | Display the System Menu and select the Transmit mode. (6-6 Transmitting the Screen Data)   |
|   | Not connected to the Support Tool.  | Check the installation of the connector cable. (3-2 Connecting to the Support Tool)  |
|   | The PT model setting and direct connection setting at the Support Tool do not match the NT631/NT631C. | Using the PT Configuration settings of the Support Tool, set the PT model and direct connection settings that match the NT631/NT631C.  |
| Cannot communicate with the host<br>Cannot switch from the system initializing screen.<br>Communications error message is displayed when communicating to the host. | Memory switch settings do not match.  | Check the communications setting in the Memory Switch menu of the Maintenance mode, and match the communications protocol settings for the host and NT631/NT631C. (6-7 Setting Conditions for Communications with Host by Using Memory Switches) |
|   | NT631/NT631C and host are not correctly connected.  | Check that the type, length, and installation of the connector cable match the specifications. (SECTION 4 Connecting to the Host from the RS-232C Port, and SECTION 5 Connecting to the Host from the RS-422A/485 Port)                          |
|   | In an RS-422A/485 connection, the terminator setting is incorrect.                                    | Make the NT631/NT631C and PLC termination resistance settings correctly. (SECTION 4 Connecting to the Host from the RS-232C Port, and SECTION 5 Connecting to the Host from the RS-422A/485 Port)  |
|   | In an NT link (1:N) connection, there is duplication in the unit numbers.                             | Make the settings again so that there is no duplication. (6-7-4 Setting the NT Link (1:N) Method (Standard/High-speed), page 158)  |
|   | The power to the NT631/NT631C, NT-AL001 or host is OFF.   | Check the power supply.  |
| The buzzer has sounded and the RUN LED is OFF.  | Malfunction due to external noise   | Carry out grounding work in accordance with the conditions by referring to 3-1-4 Grounding, page 34.   |
|   | The NT631/NT631C has developed trouble.   | Contact your OMRON service center.   |
| The touch panel does not respond.   | Malfunction due to external noise   | Carry out grounding work in accordance with the conditions by referring to 3-1-4 Grounding, page 34.   |
|   | The touch panel is broken.  | Test the touch panel with I/O Check in the MAINTENANCE MODE menu. If there is an error, contact your OMRON service center.   |
| The PLC mode has changed to the monitor mode.   | The NT631/NT631C changes the mode when Host Link communications are used.                             | This is an NT631/NT631C specification. When using a PLC that can also be connected using the NT link method, use an NT link connection (there is no mode change with the NT link method).  |

| NT631/NT631C Symptoms  | Cause  | Remedy  |
|--|--|---|
| The graph display does not change.   | One of the percentage display settings — -100%, 0%, or 100% — is incorrect.  | Set the -100%, 0%, and 100% values in the following relationship:<br>-100% value < 0% value < 100% value  |
| The trend graph display does not agree with the actual time axis.                        | The cycle for graph display update processing is longer than the set sampling cycle.   | Delete other elements on the same screen as the trend graph that are allocated to the host and have a high update frequency. Or lengthen the sampling cycle.  |
| The Programming Console function cannot be used.   | The communications settings are incorrect.   | Set the communications method as follows when using the Programming Console function. <ul style="list-style-type: none"> <li>• With C-series PLC: 1:1 NT Link</li> <li>• With CS/CJ-series PLC: 1:N NT Link (standard or high-speed)</li> </ul>             |
|  | A Programming Console is connected.  | It is not possible to use a Programming Console and the Programming Console function at the same time. Disconnect the Programming Console.  |
|  | The PLC does not support the Programming Console function.   | Not all PLCs support the Programming Console function. Check the model of PLC you are using. (6-12 <i>Programming Console Function</i> )  |
|  | The system program for other vendor's PLCs has been installed. (PLC models other than OMRON.)                                      | The Programming Console function can be used only when the system program for OMRON PLCs is installed. Install the correct system program.  |
| The Device Monitor function cannot be used.  | The communications settings are not correct.   | Set the communications method as follows when using the Device Monitor function. <ul style="list-style-type: none"> <li>• With C-series PLCs: 1:1 NT Link or 1:N NT Link</li> <li>• With CS/CJ-series PLCs: 1:N NT Link (standard or high-speed)</li> </ul> |
|  | The PLC does not support the Device Monitor function.  | Not all PLCs support the Device Monitor function. Check the model of PLC you are using. Refer to 6-13 <i>Device Monitor Function</i> for details.   |
|  | The system program installed in the PT is for a PLC maker other than OMRON.  | The Device Monitor function can be used only when the PT is connected to a PT with the system program for OMRON PLCs installed. Install a system program that supports the Device Monitor function.   |
| The memory table display contents differ from the initial value set at the Support Tool. | Since the memory table is allocated to the host memory, the display is updated in accordance with the contents of the host memory. | When the contents of the memory table are set as a fixed value, do not allocate the memory table to the host.   |
|  | The battery voltage has dropped and the data in the memory table has been destroyed.   | Replace the battery and execute memory table initialization. (7-3-1 <i>Replacing the Battery</i> , page 241, and 6-4-5 <i>Initializing the Memory Tables</i> , page 141)  |
|  | Since ON is set for the resume function, the initial values of the screen data memory are not written to the memory tables.        | Execute memory table initialization. (6-4-5 <i>Initializing the Memory Tables</i> , page 141)<br>If the resume function does not need to be used, use the NT631/NT631C with the resume function OFF. (6-9-10 <i>Setting the Resume Function</i> , page 177) |
|  | The numeral memory table is specified as the destination for a mathematical table's results.                                       | Calculations are executed continuously while the PT is operating and the calculation results are automatically written to the memory table. Specify another numeral memory table or a word in the host.   |

| NT631/NT631C Symptoms   | Cause   | Remedy   |
|---|---|--|
| Updating of numeric values and text is delayed.   | Malfunction due to external noise   | Carry out grounding work in accordance with the conditions by referring to <i>3-1-4 Grounding</i> , page 34.   |
|   | There are too many numeral/text displays on the displayed screen.   | Reduce the number of numeral/text displays on the screen for which updating is delayed.  |
|   | The cycle time is extended due to heavy processing at the host.   | Shorten the host cycle time.   |
|   | In an RS-422A/485 connection, there is illegal branching or an erroneous terminator setting.  | Wire correctly by referring to <i>SECTION 5 Connecting to the Host from the RS-422A/485 Port</i> .   |
| Some of the elements arranged on a normal screen are not displayed.   | The quantity of read data exceeds the stipulated restriction.   | Check the maximum number of elements by referring to Display Restrictions in Appendix A of the Reference Manual, creating the screen data again, and transmitting all of the screen data in a batch to the NT631/NT631C. |
|   | The total of the element coefficients for the displayed screen is greater than 1024.  |  |
| On an overlapping screen, some of the set elements are not displayed.   | Since the data is transmitted from the host in screen units, the number of elements on the overlapping screen has exceeded the maximum permissible without being checked by the Support Tool. | Check the maximum number of elements by referring to Display Restrictions in Appendix A of the Reference Manual, creating the screen data again, and then sending all the screen data in a batch to the NT631/NT631C.    |
| The System Menu cannot be called up.  | Display System Menu under Change System Settings in the System Installer mode is set to Disabled.   | In the System Installer mode, set Display System Menu to Enabled (page 147).   |
| The following System Menu operations are not possible.<br>- Establishing the Transmit mode<br>- Displaying the memory switch setting screens<br>- Screen data memory check<br>- Displaying the initialization menu<br>- Displaying the calendar/time setting screen | Screen Memory Protect under Change System Setting in the System Installer mode is set to Disabled.  | In the System Installer mode, set Screen Memory Protect to Enabled (page 147).   |
|   | Screen Memory Protect has been set to Disabled because the PT power supply was turned OFF during deletion of screen data.   | Do not turn the PT power OFF during deletion of screen data.<br>In the System Installer mode, first change the setting for Screen Memory Protect to Enabled, then repeat the screen data delete operation (page 148)     |
| Cannot input numeric values   | The upper/lower (max./min.) limit check for numeric value input is in effect.   | Check the screen data's upper/lower (max./min.) limit check setting for numeric value input, and correct it if necessary. Refer to <i>2-12 Inputting Numeric Values</i> in the Reference Manual for details.             |
| The display is too faint.   | The contrast is too high.   | Reduce the contrast (page 187).  |
| Cannot input numeric values/character strings.  | Bit 5 of the PT status control area (numeral/character string input) is set to 1 (ON).  | Set bit 5 to 0 (OFF). Refer to <i>2-2-1 PT Status Control Area (Host ↔ PT)</i> in the Reference Manual for details.  |
|   | The interlock function is set for the input field and the controlling interlock bit is OFF.   | Inputs are prohibited in input fields when the corresponding interlock bit is OFF. Check the status of the corresponding interlock bit and turn it ON.   |
| Window screen does not open   | Bit 6 of the PT status control area (PT window opening) is set to 1 (ON).   | Set bit 6 to 0 (OFF). Refer to <i>2-2-1 PT Status Control Area (Host ↔ PT)</i> in the Reference Manual for details.  |
| Cannot switch screens with touch switches   | Bit 4 of the PT status control area (PT screen switching) is set to 1 (ON).   | Set bit 4 to 0 (OFF). Refer to <i>2-2-1 PT Status Control Area (Host ↔ PT)</i> in the Reference Manual for details.  |
| Touch switch does not work. (Buzzer sounds.)  | The interlock function is set for the touch switch and the controlling interlock bit is OFF.  | Touch switches are disabled when the corresponding interlock bit is OFF. Check the status of the corresponding interlock bit and turn it ON.   |

| NT631/NT631C Symptoms                        | Cause   | Remedy  |
|--|---|---|
| The display is dim.                          | Insufficient contrast or brightness   | Increase the contrast/brightness (pages 187 and 189).   |
|  | Backlight defective, or its life has expired  | Replace the backlight (page 235).   |
| The display is too faint.                    | The contrast is too high.   | Reduce the contrast (page 187).   |
| The digits in numeral display come out as *. | The number of digits of a numeric value in a numeral memory table exceeds the set number. | <ul style="list-style-type: none"> <li>• Confirm the values of the PLC words allocated to the numeral memory table.</li> <li>• Allocate one PLC word to each numeral memory table.</li> </ul> |

## 7-2 Responding to Displayed Error Messages

When the NT631/NT631C displays an error message, find the corresponding symptoms in the appropriate table below and respond by following the Remedy indicated in the table.

For details of the error messages displayed when using Memory Unit and corrective action to take for them, refer to 3-5 *Using a Memory Unit*.

### 7-2-1 Errors Occurring at Start of Operation and Their Remedies

The table below shows the errors that can occur when the power to the NT631/NT631C is turned ON and when operation starts, and their remedies.

| Message   | Cause  | Remedy   |
|---|--|--|
| [No Comm. Protocol]<br>Set the comm. Protocol by MAINTENANCE MODE.  | No communications protocol has been set.<br>Communications protocol and screen data type are mismatched  | Using the memory switches, set the communications method to be used for communications with the host. (6-7 <i>Setting Conditions for Communications with Host by Using Memory Switches</i> )                       |
| [Screen Data Error]<br>Screen Data corrupted.<br>Initialize Screen Memory, and download Screen Data again.  | <ul style="list-style-type: none"> <li>- The power was switched OFF during screen data initialization, checking, or transmission.</li> <li>- Transmission of screen data was interrupted.</li> <li>- Illegal data has been written to the screen data memory.</li> </ul> | Initialize the screen data memory by operation at the System Menu, then re-transmit the screen data. (6-4-1 <i>Clearing Screen Data</i> , page 135)<br>If the problem persists, contact your OMRON service center. |
| [No Screen Data]<br>No Screen Data is saved in Screen Memory.<br>Download Screen Data using by the Support Tool.<br>Then set the PT to the TRANSMIT MODE, and download Screen Data again.   | No screen data is registered.  | Transmit screen data from the Support Tool.  |
| [No Direct Connection Info.]<br>No Direct Connection Information is set in Screen Data.<br>Set Direct Connecting Information in Screen Data using by the Support Tool. Then set the PT to the TRANSMIT MODE and download Screen Data again. | Allocated words have not been set for the PT status control area and PT status notify area.  | Allocate words for the PT status control area and PT status notify area with the Support Tool and then transmit the direct connection information to the NT631/NT631C.   |
| [Incorrect Screen Data]<br>Screen Data in Screen Memory do not match with the System Program.<br>Initialize Screen Memory, and download Screen Data again.  | The type of registered screen data does not match that at the NT631/NT631C.  | Initialize the screen data memory, then transmit the correct screen data. (6-4-1 <i>Clearing Screen Data</i> , page 135)   |

| Message   | Cause  | Remedy  |
|---|--|---|
| <p>[No Starting Screen]<br/>Specified Starting Screen is not saved.<br/>Fix Screen Data using by the Support Tool.<br/>Then set the PT to the TRANSMIT MODE and download Screen Data again.</p> | <p>No data is registered for either the screen number set in the PT status control area or the Initial Screen set with the Support Tool. Or the screen number which does not exist are registered.</p> | <p>Either specify a screen number for which data is registered at the PT status control area, or set the screen as the Initial Screen in the System settings under PT Configuration at the Support Tool.</p>  |
| <p>[Touch Panel is disconnected]</p>  | <p>The touch panel cable (film cable) inside the NT631/NT631C is disconnected.</p>   | <p>If this message appears after the backlight is replaced, reinstall the touch panel properly referring to <i>Replacing the Backlight</i> (page 236). If the message keeps appearing, contact your OMRON service center.</p>   |
| <p>[Memory Switch Corrupted]<br/>Because Memory Switch setting was last. Initialized Memory Switch setting.<br/>Press Confirm to return to the SYSTEM MENU.</p>                                 | <p>The memory switches have been initialized due to discovery of an error in the memory switch settings.</p>   | <p>Set the memory switches again using the System Menu and the System settings under PT Configuration at the Support Tool. (<i>SECTION 6 System Menu Operation</i>)<br/><br/>If the problem recurs, contact your OMRON service center.</p>  |
| <p>[Calendar Data Error]<br/>Calendar Data is incorrect.<br/>Set to the MAINTENANCE MODE and set Calendar Data.</p>   | <p>There is an error in the date/time values due, for example, to low battery voltage.</p>   | <p>Check the battery voltage by checking the color of the RUN LED and with the battery check in the System Menu; if the voltage is low, replace the battery with a new one. (<i>Checking the Battery Voltage</i>, page 208, and <i>7-3-1 Replacing the Battery</i>, page 241)<br/><br/>If the battery voltage is confirmed to be normal, set the calendar clock correctly from the System Menu. (<i>6-11-2 Displaying/Setting the Calendar and Clock</i>, page 191)</p> |
| <p>[Backup Data Error]<br/>Memory table and History data was initialized by backup failure.<br/>It can be caused by lowered voltage of the battery.</p>   | <p>Initialization has been executed because of an error in the backup data area.</p>   | <p>Check the battery voltage by checking the color of the RUN LED and with the battery check in the System Menu; if the voltage is low, replace the battery with a new one. (<i>Checking the Battery Voltage</i>, page 208, and <i>7-3-1 Replacing the Battery</i>, page 241)<br/><br/>The re-transmit the memory table data from the Support Tool.<br/><br/>If the voltage is normal and the problem recurs, contact your OMRON service center.</p>                    |
| <p>[With memory switch setting screen]<br/>Invalid Comm. Method</p>   | <p>Protocol settings for serial port A and serial port B are mismatched.</p>   | <p>Refer to <i>Possible Combinations of Communications Method Settings</i> on page 154 and set the protocol of serial port A and serial port B so that their settings are matched.<br/><br/>* Set serial port A to None when connecting the Support Tool and the host at the same time.</p>   |



### 7-2-2 Errors Occurring during Operation and Their Remedies

The table below shows the errors that can occur during operation of the NT631/NT631C and their remedies.

| Message   | Cause  | Remedy   |
|---|--|--|
| [Address Setting Error]<br>Addressing Error exists in the Screen.<br>Correct address setting by the Support Tool.   | The host side allocated words and bits set with the Support Tool are incorrect.  | Set correct words and bits after checking the area used at the host side by referring to PLC Memory Map in Appendix D of the Reference Manual or the Operating Manual for the PLC being used.  |
| [Memory Table No. Error]<br>Memory table No. is out of limit.<br>Correct the table No. by the Support Tool.   | The memory table number set with the Support Tool is outside the range for the number of memory tables set in the system memory. | Either increase the number of memory tables in the System settings under PT Configuration at the Support Tool, or set the memory table number again within the established range.  |
| [Programming Console Error]<br>Setting of Programming Console Function is inadequate. It can be caused by:<br><ul style="list-style-type: none"> <li>• This PLC does not support Programming Console Function.</li> <li>• Protocol mismatch. Set the PLC to NT Link.</li> <li>• "PROGRAMMING CONSOLE" is connected to PLC.</li> </ul> | The communications settings are incorrect.   | Set the communications method/communications port as follows when using the Programming Console function.<br><ul style="list-style-type: none"> <li>• With C-series PLCs: 1:1 NT Link</li> <li>• With CS/CJ-series PLCs: 1:N NT Link (standard or high-speed)</li> </ul> |
|   | The PLC used does not support the Programming Console function.  | Not all PLCs support the Programming Console function. Check the model of the PLC you are using. (6-12 Programming Console Function)   |
|   | A Programming Console is connected.  | It is not possible to use a Programming Console and the Programming Console function at the same time. Disconnect the Programming Console.   |
| [Programming Console Error]<br>Programming Console Function does not RUN. It can be caused by:<br><ul style="list-style-type: none"> <li>• Connecting cable is faulty.</li> <li>• "PROGRAMMING CONSOLE" is connected to PLC.</li> <li>• Protocol mismatch between the PT and PLC. Set the PLC to NT Link.</li> </ul>                  | The connecting cable is defective.   | Check the cable connection and perform a conductivity test. If there is a fault, replace the cable.  |
|   | Malfunction due to external noise  | Carry out grounding work in accordance with the conditions by referring to 3-1-4 Grounding, page 34.   |
|   | A Programming Console is connected.  | It is not possible to use a Programming Console and the Programming Console function at the same time. Disconnect the Programming Console.   |
|   | The communications conditions at the PLC have been changed in accordance with the NT631/NT631C Programming Console function.     | Set the communications conditions at the PLC to match the conditions set in the System Menu.   |

### 7-2-3 Errors Occurring on Screen Data Initialization and Transmission

The table below shows the errors that can occur when the NT631/NT631C data is initialized, and during data setting and transmission, and their remedies.

| Message   | Cause  | Remedy   |
|---|--|--|
| [Flash Memory Error]<br>Flash Memory I/O Error.<br>If this happens frequently, Flash Memory may be broken.<br>Press Reset Switch to restart.      | There is a hardware fault, or the flash memory (memory for storing screen data) has reached the end of its service life. | If the same message is displayed even after clearing the screen data or transmitting screen data several times, contact your OMRON service center.   |
| [Calendar Data Error]<br>Calendar Data is incorrect.<br>Set to the MAINTENANCE MODE and set Calendar Data.  | Hardware fault, or system program error  | Set the calendar clock again from the System Menu. If the problem recurs, delete the program in the System Installer mode, then re-install the program. (6-5-2 <i>Clearing/Installing the System Program</i> , page 145)<br>If this does not solve the problem, contact your OMRON service center. |
| [Tool Transmit Error]<br>**** Error detected while downloading by the following case:<br>• faulty connecting cable.<br>• corrupted data by noise. | The connecting cable is defective.   | Check the cable connection and perform a conductivity test. If there is a fault, replace the cable. ( <i>Appendix F Making the Cable for Connecting a PLC</i> )  |
|   | Malfunction due to external noise  | Carry out grounding work in accordance with the conditions by referring to 3-1-4 <i>Grounding</i> , page 34.   |
| [Tool Transmit Error]<br>Check Sum Error occurs while downloading by the following case:<br>• corrupted data by noise.                            | Malfunction due to external noise  | Carry out grounding work in accordance with the conditions by referring to 3-1-4 <i>Grounding</i> , page 34.   |
| [Tool Transmit Error]<br>Time-out Error occurs while downloading by the following case:<br>• faulty connecting cable.                             | The connecting cable is defective.   | Check the cable connection and perform a conductivity test. If there is a fault, replace the cable.  |
| [Tool Transmit Error]<br>Reception was failed by Buffer Over Flow Error.  | The receive buffer has overflowed.   | Retransmit the data from the Support Tool.   |

### 7-2-4 Errors in the System Installer Mode and Their Remedies

This section describes the errors that may occur in the System Installer mode of the NT631/NT631C, and the remedies for these errors.

| Message                                | Cause  | Remedy   |
|--|--|--|
| System Program not exist or incorrect. | - The system program has not been installed.<br>- The system program has been deleted due to a hardware fault, or because the flash memory (memory for storing the system program) has reached its life. | Select Download System Program and download the system program (6-5-2 <i>Clearing/Installing the System Program</i> , page 145)<br>If this does not solve the problem, contact your OMRON service center.  |
| Unable to erase System Program.        | Hardware fault, or flash memory (memory for storing the system program) has reached its life.  | If the same message is displayed on repeating selection of Download System Program and attempting to delete the system program several times, contact your OMRON service center (6-5-2 <i>Clearing/Installing the System Program</i> , page 145) |

| Message                            | Cause  | Remedy  |
|------------------------------------|--|---|
| Unable to download System Program. | <ul style="list-style-type: none"> <li>- A communications error occurred during downloading of the system program.</li> <li>- Illegal data has been written into the screen data memory.</li> <li>- Hardware fault, or flash memory (memory for storing the system program) has reached its life.</li> </ul> | Select Download System Program and download the system program again ( <i>6-5-2 Clearing/Installing the System Program</i> , page 145)<br>Also refer to <i>7-2-3 Errors Occurring on Screen Data Initialization and Transmission</i> (page 232), and take the corrective action described for tool transmission errors.<br>If this does not solve the problem, contact your OMRON service center. |
| Unable to write System Settings.   | Hardware fault, or flash memory (memory for storing the system program) has reached its life.  | If the same message is displayed on repeating writing of system settings several times, contact your OMRON service center.<br>If writing is normally terminated after the error message was once displayed, the Memory Switch setting for system program may have been altered. In such a case, check and reset the setting in the Memory Switch menu of the Maintenance mode.                    |
| Unable to erase Screen Data.       | Hardware fault, or flash memory (memory for storing the system program) has reached its life.  | If the same message is displayed on repeating screen data deletion several times, contact your OMRON service center.  |

### 7-2-5 Communications Errors and Their Remedies

This section describes the errors relating to communications that can occur during operation, and their remedies.

#### Operation When a Communications Error Occurs

When a communications error occurs, the error message is displayed at the NT631/NT631C, and the buzzer sounds, provided the setting made for Buzzer Sound in the System Menu is other than OFF. An error message is displayed provided the setting for the Comm. Auto-Return memory switch is not ON (note that some error messages are displayed even if the setting is ON).

#### Operation When Communications Errors Occur

When an error message is displayed, after removing the cause of the error, press the OK touch switch displayed on the screen. The NT631/NT631C will return to the screen that was displayed before the error occurred, and operation will restart.

#### Display of Communications Errors

For communications errors, the name of the port at which the error occurred, the error classification (send or receive error), the details of the error, the probable cause, and the remedy, are displayed as shown below.

#### Example:

Parity error at serial port A

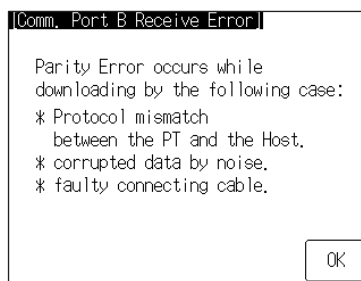

#### Receive Errors

The following errors can occur when receiving data.

- Parity error
- Framing error

- Overrun error
- FCS (sum value) error
- Time out error
- Data over flow error
- PLC unit No. error (Host Link only)
- NAK received (in the case of the Host Link, the end code is also displayed)
- Undefined command error

**Send Errors**

The following errors can occur when receiving data.

- Time out error
- Data over flow error

**Probable Causes and Remedies**

The remedies to take in accordance with the displayed cause are indicated in the table below.

| Error Details                                   | Displayed Probable Cause  | Remedy  |
|---|---|---|
| Parity Error<br>Framing Error<br>Over-run Error | Communications parameters/ conditions set incorrectly.            | Check if the settings at the host for parity bit, frame length, communications speed, stop bit length and flow control agree with those at the NT631/NT631C.  |
|   | The connecting cables are not connected correctly.                | Check the communications cable connection and perform a conductivity test. If there is a fault, replace the cable. For details on communications cables, refer to <i>SECTION 4 Connecting to the Host from the RS-232C Port</i> , and <i>SECTION 5 Connecting to the Host from the RS-422A/485 Port</i> . |
|   | Noise caused data corruption during communications.               | Carry out grounding work in accordance with the conditions by referring to <i>3-1-4 Grounding</i> , page 34.  |
| FCS (Check Sum) Error                           | Noise caused data corruption during communications.               | Carry out grounding work in accordance with the conditions by referring to <i>3-1-4 Grounding</i> , page 34.  |
|   | The PLC is transmitting incorrect data.                           | Check the operation at the host side.   |
| Time-out Error                                  | The connecting cables are not connected correctly. (Send/Receive) | Check the communications cable connection and perform a conductivity test. If there is a fault, replace the cable. For details on communications cables, refer to <i>SECTION 4 Connecting to the Host from the RS-232C Port</i> , and <i>SECTION 5 Connecting to the Host from the RS-422A/485 Port</i> . |
|   | The communications service of the host is stopped. (Send/Receive) | Check that the host is capable of communicating with the NT631/NT631C (confirm that the communications settings of the host and NT631/NT631C match).  |
|   | Time-out Interval is too short. (Send)                            | Set a longer value for Time-out Interval at the host side.  |
|   | Time-out Interval is too short. (Receive)                         | Set a longer value for Time-out Interval in the System Menu. ( <i>6-9-12 Setting the Time-out Interval</i> , page 181) It may also be possible to solve the problem by shortening the host cycle time.  |
| PLC Unit No. Error                              | The unit # does not match that set on the PLC.                    | Re-set the unit number at the host side to 0.   |
|   | Noise caused data corruption during communications.               | Carry out grounding work in accordance with the conditions by referring to <i>3-1-4 Grounding</i> , page 34.  |

| Error Details           | Displayed Probable Cause  | Remedy  |
|-------------------------|---|---|
| NAK received            | —   | Check the settings for allocated words and bits.<br>If noise is a possible factor, distance the cable from sources of noise and insert a noise filter in the power supply line.<br>If using the equipment in a location subject to a lot of noise, use a cable with a high degree of protection against noise for the transmission route. Also make the cable as short as possible. |
| Undefined Command Error | The host is not supported.  | Check the PLC model used for the host.  |
|                         | Instruction level 3 is not effective.                                   | Check that the instruction level setting for the host is level 1, 2, 3.   |
| Data Over Flow Error    | Communications command from the host is too long.<br>(With memory link) | Set flow control method in the host.<br>Increase transmission interval.   |
|                         | Command transmission to the host is not possible.                       | Check the communications cable.<br>Check the control method at the PT and the host.<br>Increase the communications on speed when it to slow.  |

## 7-3 Maintenance of the NT631/NT631C

Carry out maintenance work in order to ensure that the NT631/NT631C is always used in its optimum condition.

### WARNING

Do not attempt to take the unit apart and do not touch any internal parts while the power is being supplied. Doing either of these may result in electrical shock.



### Spare PT

It is advisable to have a spare NT631/NT631C available to minimize system downtime in the event of an NT631/NT631C failure or if the screen display becomes difficult to read due to deterioration of the display unit.

### Backlight (for NT631C-ST141□-EV2/ST151□-EV2 only)

When the backlight in the display is getting dim and the screen cannot be read easily, replace the backlight. The backlight can be replaced at the rear of the NT631C-ST141□-EV2/ST151□-EV2 while it is mounted in an operation panel. The backlight for NT631C-ST152□-EV2 and NT631C-ST153□-V3 cannot be replaced by the user. Contact your OMRON service center when the backlight needs to be replaced.

#### Replaceable Backlight Model

NT631C-CFL01 (for NT631C-ST151□-EV2)

The backlight for the NT631C-ST152□-EV2/ST153□-EV3 cannot be replaced by the user. Contact your OMRON service center when the battery needs to be replaced.

NT631C-CFL02 (for NT631C-ST141□-EV2)

#### Guide to Backlight Replacement

Use the following as a guide to backlight replacement.

NT631C-ST141□-EV2: Approx. 25,000 hours

NT631C-ST151□-EV2: Approx. 30,000 hours

The life of the backlight varies, particularly in accordance with the temperature in the environment in which it is used. It should be replaced when it becomes dim and the screen becomes hard to read.

The life expectancy of the backlight for the NT631C-ST152□-EV2/ST153□-EV3 at high brightness is 50,000 hours. The backlight cannot be replaced by the user, however. Contact your OMRON service center when the backlight needs to be replaced.

### Notes on Replacing the Backlight

Pay attention to the following points when replacing the backlight.

- Carry out the replacement work in a location where there is no danger that dust or foreign bodies will enter the Unit, and where no water will drip onto it.



Do not touch the printed circuit boards of the NT631C-ST141□-EV2/ST151□-EV2 with your bare hands.

Also, discharge the static electricity from your body before starting the work.

- Do not carry the Backlight Unit by holding only its cable, or pull on the cable. Do not subject the backlight to excessive force or shock.
- Do not disassemble the product to repair or modify it.

### Replacing the Backlight

Use the following procedure to replace the backlight.

|   |  |
|---|--|
|  <b>WARNING</b>  |  |
| <p>Switch OFF the NT631C-ST141□-EV2/ST151□-EV2 power before replacing the backlight. Otherwise you could sustain an electric shock.</p> |  |

Replace the backlight by following the procedure given below:

### NT631C-CFL01 (for NT631C-ST151□-EV2)

#### Procedure

- 1,2,3...**
1. Turn the power supply to the PT OFF.  
Be sure to do so to avoid an electric shock.
  2. Disconnect the terminal block wiring, the communications cable, and the printer cable. If a Memory Unit or Interface Unit is mounted, remove that Unit also.
  3. Loosen four screws at corners on the rear face of the NT631C, and remove the rear case.  
Be careful not to lose these screws.  
From this step on, exert added care not to touch any electronic parts or printed circuit boards inside the Unit. Otherwise the PT may sustain static damage.
  4. Disengage two backlight connectors at the top and the bottom, and pull out the touch panel cable.

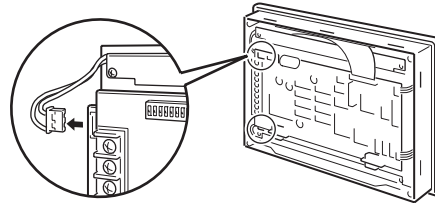

### **Removing and Fitting The Touch Panel Cable**

#### **Removing The Touch Panel Cable:**

Pull the arrow-marked sections up to the cable side to unlock the connector, and remove the cable.



#### **Fitting The Touch Panel Cable:**

While unlocking the connector, insert the touch panel cable fully. Then, lock the connector.

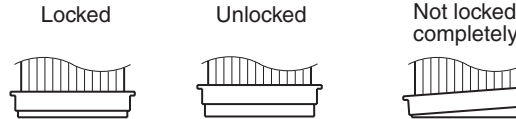

5. Loosen two mounting screws, and remove the backlight. When loosening or tightening screws for backlights, be sure to use a magnetized Phillips screwdriver. If any screw falls inside the Unit, it must be extricated without fail.

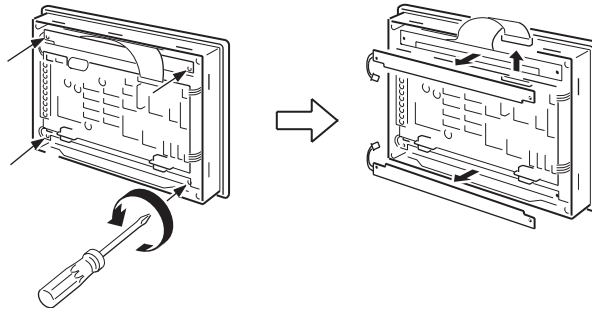

6. Fit new backlights.  
The backlight for the top is different from that for the bottom. Each backlight has three projections. Slot these projections into slits on the Unit, and tighten the screws while lightly holding the backlight by fingers. Make sure that the cable does not come out of the backlight. If it comes out, put it in the backlight and then tighten the screws. The tightening torque must be 0.2 N·m.

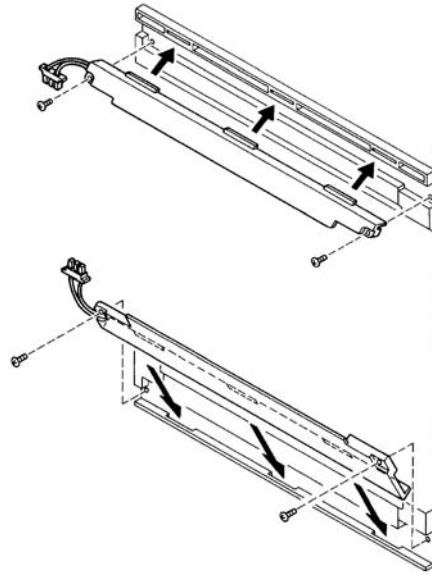

7. Engage backlight connectors at the top and the bottom respectively in place. The backlight cable has a polarity; refer to the figure below.

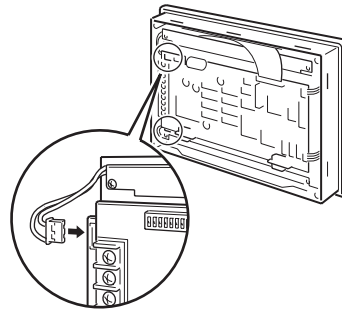

8. Fit the touch panel cable. Be sure to lock the connector as in step 4 after fitting.
9. Close the rear case, and tighten four screws. Make sure that the internal cable is not trapped.
10. Reconnect the wiring, cables, and Units disconnected in 2, and tighten the screws at a torque of 0.4 N·m.  
Turn the power on, and check that the RUN LED is not flashing and that no buzzer is sounding.  
If the RUN LED flashes at 1-s intervals and a buzzer sounds intermittently, the touch panel cable is disconnected. Follow the above steps from 1, and check the lock status of the connector.
11. Before starting normal operation, confirm that the following tests can be executed correctly by using the I/O check in the Maintenance menu. Also perform a communications test with the host.
  - Touch switch
  - Backlight
12. On confirming that all the tests in 11 can be executed normally, start operation.



**NT631C-CFL02 (for NT631C-ST141□-EV2)**

**Procedure**

- 1,2,3...**
1. Turn the power supply to the PT OFF.  
Be sure to do so to avoid an electric shock.
  2. Disconnect the terminal block wiring, the communications cable, and the printer cable. If a Memory Unit or Interface Unit is mounted, remove that Unit also.
  3. Loosen four screws at corners on the rear face of the NT631C, and remove the rear case.  
Be careful not to lose these screws.  
From this step on, exert added care not to touch any electronic parts or printed circuit boards inside the Unit. Otherwise the PT may sustain static damage.
  4. Disengage two backlight connectors at the top and the bottom, and pull out two touch panel cables at the top.

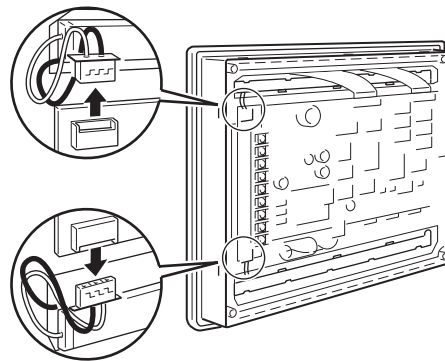

**Removing and Fitting The Touch Panel Cable**

**Removing The Touch Panel Cable:**

Pull the arrow-marked sections up to the cable side to unlock the connector, and remove the cable.



**Fitting The Touch Panel Cable:**

While unlocking the connector, insert the touch panel cable fully. Then, lock the connector.



5. Loosen mounting screws, and remove backlights.  
Shift the backlight to the right, and pull it out.  
When loosening or tightening screws for backlights, be sure to use a magnetized Phillips screwdriver. If any screw falls inside the Unit, it must be extricated without fail.

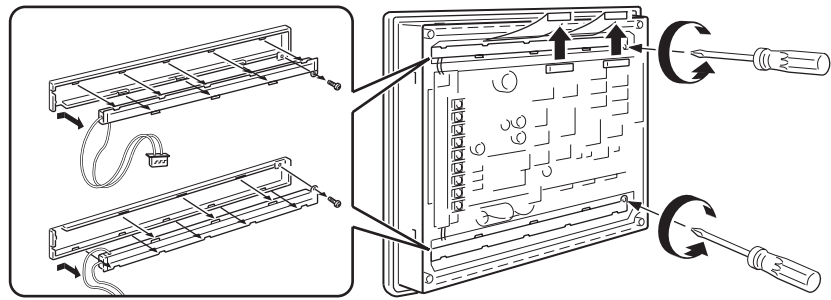

6. Fit new backlights.  
 The backlight for the top is different from that for the bottom.  
 Fit projections and dents of the backlight with those on the fixture, and shift the backlight to the left. Check that the backlight is in contact with the left end of the fixture and the cable comes out from the notch without being trapped.  
 When the backlight is correctly fit, tighten the screws at a torque of 0.1 N·m.

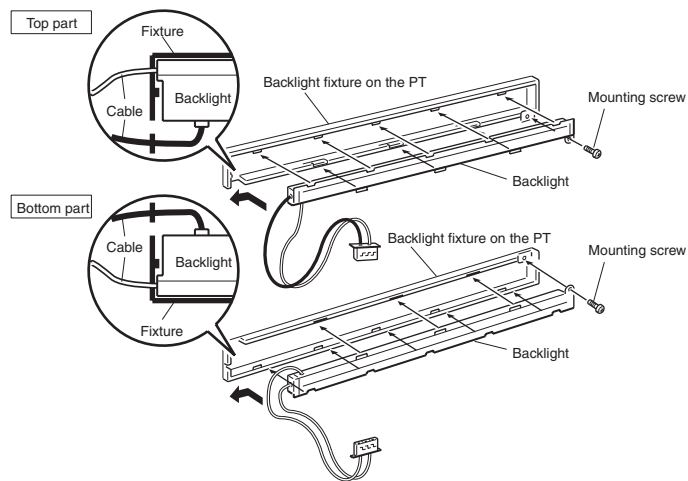

7. Engage backlight connectors at the top and the bottom respectively in place. The backlight cable has a polarity; refer to the figure below.

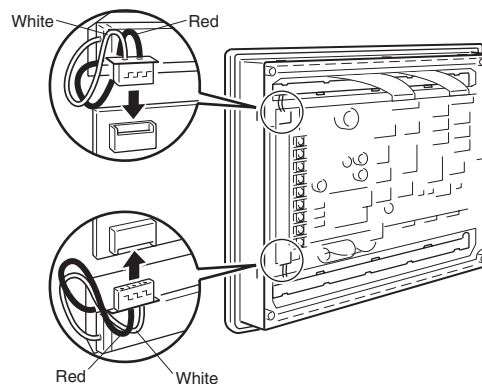

8. Fit two touch panel cables at the top. Be sure to lock the connectors as in step 4 after fitting.
9. Close the rear case, and tighten four screws. Make sure that the internal cable is not trapped.

10. Reconnect the wiring, cables, and Units disconnected in **2**, and tighten the screws at a torque of 0.4 N·m.  
Turn the power on, and check that the RUN LED is not flashing and that no buzzer is sounding.  
If the RUN LED flashes at 1-s intervals and a buzzer sounds intermittently, the touch panel cable is disconnected. Follow the above steps from **1**, and check the lock status of the connector.
11. Before starting normal operation, confirm that the following tests can be executed correctly by using the I/O check in the Maintenance menu. Also perform a communications test with the host.
  - Touch switch
  - Backlight
12. On confirming that all the tests in **11** can be executed normally, start operation.

### 7-3-1 Replacing the Battery

The NT631/NT631C uses a lithium battery to back up the memory contents. The battery life is about 5 years if the NT631/NT631C is used in a location where the ambient temperature is 25°C. If the temperature at the location of use is higher than this, the battery life will be shorter. Change the battery at suitable intervals in accordance with the operating environment of the NT631/NT631C.

It is advisable to keep a spare battery so that the battery can be replaced immediately when replacement becomes necessary.

#### **Battery Type**

3G2A9-BAT08 (for both NT631 and NT631C)

#### **Guide to Replacement**

Replace the Battery in the following cases.

If the power supply to the PT is left turned OFF after a low battery voltage has been detected, the memory backed up by the battery may be corrupted.

Replace the Battery within 5 minutes of turning OFF the power supply to the PT.

- When 5 years have passed since the installation of a new battery.
- When the RUN LED is lit in orange (during operation) or in red (when stopped).
- When the message The voltage is lowered. is displayed on switching on the power or resetting the NT631/NT631C.
- When The voltage is lowered is displayed in the Battery check in the battery check menu of the Maintenance mode.

#### **Battery Replacement Method**

Replace the battery by following the procedure given below.

To protect the contents of the memory, the battery must be replaced within 5 minutes.

#### **Procedure**

- 1,2,3...**
1. Keep the power ON for at least 5 minutes and then turn it OFF.

**Reference:** Unless the power is kept ON for at least 5 minutes, the memory contents cannot be retained for more than 5 minutes without a battery.

2. Insert a flat blade screwdriver at the top of the battery cover located at the left of the rear face of the NT631/NT631C and pull it toward you.

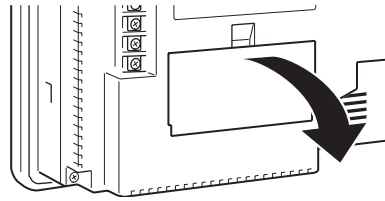

3. Remove the battery that is secured under the battery cover, grip the cable, and pull the connector straight out.

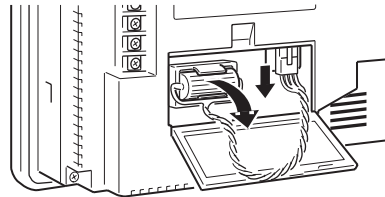

4. Insert the connector of the new battery into the connector on the NT631/NT631C and fit the battery under the battery cover.

When inserting the battery connector, make sure that the projection on it faces to the left, and press it fully home while keeping it straight.

The connector of the new battery must be connected within 5 minutes after disconnecting the old battery's connector. However, the battery can be replaced while the NT631/NT631C power is on, and in this case there is no time restriction.

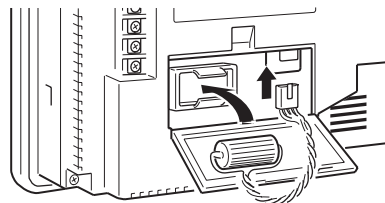

5. Close the battery cover, making sure that the cable is not trapped.

## 7-4 Inspection and Cleaning

Clean and inspect the NT631/NT631C regularly to ensure that it is always used in its optimum condition.

### Cleaning Method

If the display is dirty the screen is difficult to see. Clean the screen from time to time as follows.

- In daily cleaning, wipe the display with a soft dry cloth. If the soiling is particularly heavy, attempting to remove it by wiping with a dry cloth may damage the front sheet of the Unit. In this case, wipe with a damp cloth.
- If the soiling cannot be removed with a dry cloth, wet the cloth with diluted neutral detergent (2%), wring it out well and wipe the display with it.
- If rubber or vinyl products, tape, etc., are left stuck to the display for long periods they will cause staining. If such items are stuck to the display, remove them during cleaning.

**Note** Never use volatile solvents such as benzene or thinners, or chemical dusters.

**Inspection Method**

In normal environments, inspect the NT631/NT631C at intervals of between 6 months and a year. In environments that are extremely hot and humid, or very dusty environments, shorten the inspection interval.

**Items Required for The Inspection**

Prepare the following items before starting the inspection.

- Screwdrivers (Phillips, flat head)
- Tester (or digital voltmeter)
- Industrial alcohol
- 100% cotton cloth
- Hygrometer (required in some cases)
- Thermometer (required in some cases)
- Synchroscope (required in some cases)
- Pen-writing oscilloscope (required in some cases)

**Points Inspected**

Inspect the following points to determine if there is any divergence from the stated criteria. If there is, either improve the surrounding environment so that the values fall within the stated range, or adjust the NT631/NT631C, for example by re-tightening screws.

| Point Inspected                  | Inspection Details                                       | Criterion   | Inspection Instrument |
|----------------------------------|--|---|-----------------------|
| Power supply voltage             | Fluctuation in power supply terminal voltage             | Permissible voltage fluctuation range 20.4 to 26.4 VDC (24 VDC -15% to +10%)  | Tester                |
| Ambient environmental conditions | Ambient temperature (temperature in the operation panel) | 0 to 50°C   | Thermometer           |
|                                  | Ambient humidity (humidity in the operation panel)       | 35% to 85% RH   | Hygrometer            |
|                                  | Presence/absence of dust                                 | Dust must not be settled  | Visual inspection     |
| Mounting conditions              | Looseness of mounting brackets, etc.                     | To be no looseness  | Phillips screwdriver  |
|                                  | Connector connections of connecting cable                | To be fully inserted and locked, with no looseness  | Phillips screwdriver  |
|                                  | Looseness of screws in external wiring                   | To be no looseness  | Phillips screwdriver  |
|                                  | Conditions of external connecting cables                 | Faults such as incipient disconnection  | Visual inspection     |
| Components with limited lives    | Brightness of the backlight (NT631C only)                | Must be sufficiently bright.<br>Backlight life:<br>(Under the normal range of ambient temperature and humidity)<br>NT631C-ST141□-EV2: Approx. 25,000 hours or longer<br>NT631C-ST151□-EV2: Approx. 30,000 hours or longer<br>NT631C-ST152□-EV2/ST153□-EV3: Approx. 50,000 hours or longer<br>(Brightness setting is not available for the NT631C-ST151/152□-EV2/ST153□-EV3 and the backlight cannot be replaced.) | Visual inspection     |

**Note** 1. Do not disassemble for repairs or modification.

2. The disposal of the Unit (including batteries to be disposed and backlight) may be regulated by national or local authorities. Dispose of them in accordance with the laws and regulations of the relevant country and local authority.

**Reference:**

- Desire on replacing the NT631/NT631C
- When replacing the NT631/NT631C after discovering a fault during inspections, note the following points:
- Be sure to switch the power OFF before starting replacement.
- After replacement, check that the new NT631/NT631C is not subject to the same error.
- If a faulty Unit is returned for repairs, write as detailed a description of the fault as possible and send this description together with the Unit to the OMRON address indicated on the back cover of this book.

# Appendix A

## Specifications

### General Specifications

| Item                                 | Specifications   |   |  |
|--------------------------------------|--|---|--|
|                                      | NT631-ST211□-EV2   | NT631C-ST141□-EV2   | NT631C-ST153□-EV3  |
| Rated power supply voltage           | 24 VDC   |   |  |
| Allowable power supply voltage range | 20.4 VDC to 26.4 VDC (24 VDC -15% to +10%)   |   |  |
| Allowable power interruption time    | No regulation  |   |  |
| Power consumption                    | 30 W max.  | 18 W max.   |  |
| Power starting time                  | 200 ms max.  | ---   |  |
| Operating ambient temperature        | 0 to 50°C  | 0 to 40°C   | 0 to 50°C*1  |
| Storage ambient temperature          | -20 to +60°C*1   |   |  |
| Operating ambient humidity           | 35% to 85% (with no condensation)  |   | 10% to 90%*1 (with no condensation)  |
| Operating environment                | No corrosive gases   |   |  |
| Noise immunity                       | Common mode: 1000 Vp-p (between power supply terminals and panel)<br>Normal mode: 300 Vp-p<br>Pulse width of 100 ns to 1 μs, pulse rise time of 1 ns |   | Conforms to IEC61000-4-4.<br>2 kV (power line)   |
| Vibration resistance (operating)     | 10 to 57 Hz with 0.075-mm single amplitude for 30 minutes each in X, Y, and Z directions   | 57 to 150 Hz with 9.8 m/s <sup>2</sup> and 10 to 57 Hz with 0.075-mm single amplitude for 30 minutes each in X, Y, and Z directions | 5 to 9 Hz with 3.5-mm single amplitude and 9 to 150 Hz with 9.8 m/s <sup>2</sup> acceleration 10 times each in X, Y, and Z directions (1 octave/min) |
| Shock resistance (operating)         | 147 m/s <sup>2</sup> 3 times each in X, Y, and Z directions  |   |  |
| Dimensions                           | 315 × 250 × 54 (W × H × D) mm<br>(With Expansion Unit mounted: 315 × 250 × 74 (W × H × D) mm)  |   |  |
| Panel cutout dimensions              | 303 <sup>+0.5</sup> <sub>0</sub> × 238 <sup>+0.5</sup> <sub>0</sub> mm<br>Circle of panel pressure 1.6 to 4.8 mm                                     |   |  |
| Weight                               | 2.5 kg max.  |   |  |
| Degree of protection                 | Front panel: Protection equivalent to oil-proof IP65 (NEMA4). *2   |   |  |
| Grounding                            | D-type grounding (Ground to 100 Ω or less)   |   |  |

\*1: Use the NT631C-ST153□-EV3 within the following temperature and humidity ranges.

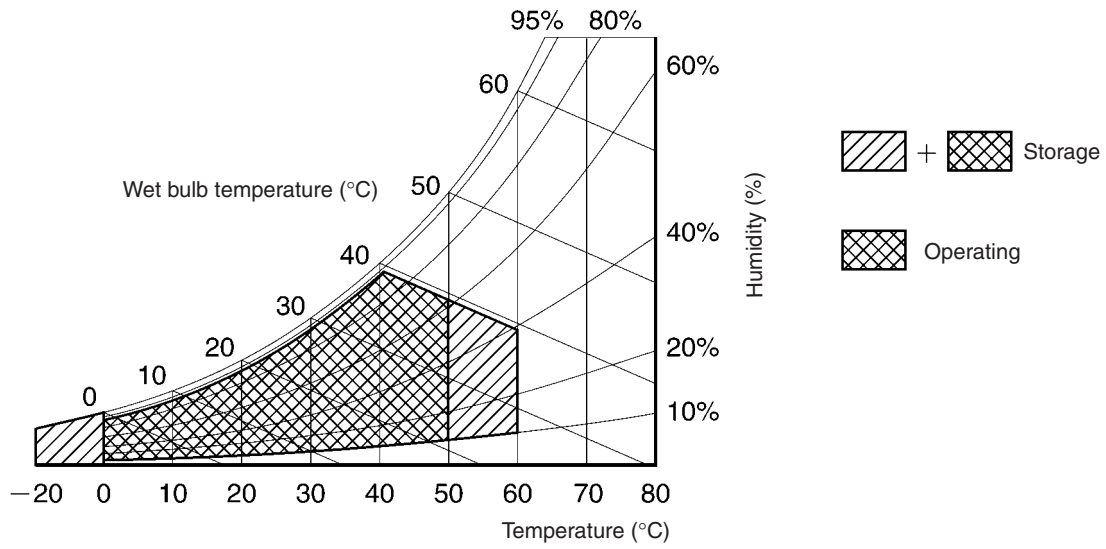

\*2: The NT631/NT631C may not be used at a location where it is exposed to splashing oil for a long period.



## Performance Specifications

### Display Specifications

| Item          |                              | Specification  |   |   |
|---------------|------------------------------|--|---|---|
|               |                              | NT631-ST211□-EV2   | NT631C-ST141□-EV2   | NT631C-ST153□-EV3                                     |
| Display panel | Display device               | EL (monochrome)  | Color STN LCD (with backlight)  | Color TFT high-precision LCD (with backlight)         |
|               | Number of dots (resolution)  | 640 dots horizontally × 480 dots vertically  |   |   |
|               | Size of a standard character | 5.28 mm  | 5.76 mm   | 5.28 mm   |
|               | Effective display area       | 211 mm horizontally × 158 mm vertically (10.4 inches)  | 229 mm horizontally × 172 mm vertically (11.3 inches)                             | 211 mm horizontally × 158 mm vertically (10.4 inches) |
|               | View angle                   | (No restriction)   | Up/down: ±30°<br>Left: 55°<br>Right: 45°  | Up: 35°<br>Down: 65°<br>Left: 60°<br>Right: 60°       |
|               | Display color                | Orange, black (2 colors)   | 8 colors (and intermediate colors can be displayed with tiling patterns)          |   |
|               | Life expectancy              | 30,000 hours min. (until brightness reduced by 30%)  | 50,000 hours min. (until brightness reduced by 50%)                               |   |
|               | Contrast adjustment          | (Not provided)   | Adjustable in 100 levels by operation at the touch panel                          | (Not provided)  |
| Backlight     | Life expectancy              | ---  | 25,000 hours min.* <sup>1</sup>   | 50,000 hours min.* <sup>1</sup>                       |
|               | Replacement                  | ---  | Can be replaced from the rear by the user   | Cannot be replaced by the user                        |
|               | Brightness adjustment        | (Not provided)   | Adjustable in 3 levels by touch switch operation at the touch panel* <sup>2</sup> | (Not provided)  |
|               | Automatic turn-off function  | Can be set to turn off in 1 to 255 minutes, or to remain on  |   |   |
| Indicators    | POWER (green LED)            | Lit while power is being supplied  |   |   |
|               | RUN                          | Lit in green: Operating normally, Memory Unit automatic transmission completed<br>Flashing in green: Memory Unit automatic transmission being executed, Memory Unit automatic transmission error<br>Lit in orange: Low battery voltage (during operation)<br>Lit in red: Low battery voltage (when operation is stopped) |   |   |

\*1: Time taken for brightness to reduce to half at normal temperature and humidity

\*2: Sharp brightness adjustment is not available.

## Panel Specifications

| Item  | Specification   |
|---|---|
| Touch panel                                     | Type: Resistive type                                      |
|   | Number of switches: 768 (32 horizontally × 24 vertically) |
|   | Maximum number that can be registered on one screen: 256  |
|   | Cell size: NT631-ST211□-EV2      5.9 × 5.9 mm             |
|   | NT631-ST141□-EV2      6.5 × 6.5 mm                        |
|   | NT631-ST153□-EV3      5.9 × 5.9 mm                        |
|   | Input: Pressure-sensitive type                            |
| Operating force: 1 N minimum                    |   |
| Life expectancy: One million operations minimum |   |

## External Interface Specifications

| Item                  | Specification  |
|-----------------------|--|
| Serial communications | Serial port A<br>Conforms to EIA RS-232C.<br>D-SUB 9-pin connector (female)<br>+5 V (250 mA max.) output at pin No. 6                        |
|                       | Serial port B connector*<br>EIA RS-232C (Serial port B terminal block selectable by memory switch setting)<br>D-SUB 9-pin connector (female) |
|                       | Serial port B terminal block*<br>EIA RS-422A/485 (Serial port B connector selectable by memory switch setting)<br>Terminal block             |
| Parallel interface    | Conforms to Centronics standard, 20-pin half pitch connector   |
| Expansion interface   | Dedicated connector  |

\* Serial port B is used for either a connector or terminal block.

**Note** Check that the current capacity of the equipment to be supplied is within 250 mA before using the +5 V output of pin No. 6.

The +5 V output of the Unit delivers +5 V ± 5% and 250 mA maximum.

## Programming Environment

| Item               | Specification  |
|--------------------|--|
| Programming System | Programming support software   |
| Programming Tool   | Programming support software<br>NT-series Support Tool for Windows (Ver. 4.□), made by OMRON |

## Special Features

| Item                        | Specifications   |
|-----------------------------|--|
| Buzzer                      | <p>Three kinds of buzzer sound (continuous, short intermittent, and long intermittent)</p> <p>ON: On reception of a command from the host, display of a screen with a buzzer setting, or display of an error screen such as for a receive error.</p> <p>OFF: On reception of a command from the host, or display of a screen with no buzzer setting.</p> <p>Setting: Set "ON" for "Buzzer Sound" in the memory switch menu, or set "ERROR ON" for the buzzer to sound only when an error occurs.</p> <p>The buzzer sounds three times in response to prohibited input.</p>   |
| Touch switch input sound    | <p>Touch switches</p> <p>Input sound: Sounding for 0.2 seconds</p> <p>Setting: Set "ON" for "Key Press Sound" in the memory switch menu.</p>   |
| Maintenance function        | <ul style="list-style-type: none"> <li>- Memory switch setting</li> <li>- Self-test functions, such as for the memory and external interface</li> <li>- Setting condition confirmation function</li> <li>- Communications check function</li> <li>- Initialization of internal memory data</li> <li>- Display of display/alarm history data</li> <li>- Registered data test display function</li> </ul>  |
| Battery backup              | <ul style="list-style-type: none"> <li>- Backup of numeral/character string memory table data in the NT631/NT631C</li> <li>- Backup of display/alarm history data</li> <li>- Backup of calendar and clock setting</li> </ul> <p>Battery life: 5 years (at 25°C)</p> <p>When voltage becomes low: RUN LED lights in orange or red<br/>The communications flag to the PLC (BAT LOW) comes ON (1).</p>  |
| Resume function             | <p>Retains the contents of the numeral/character string memory tables (i.e., they are not initialized) when the power is turned ON, when the NT631/NT631C is reset, and when the operation mode is changed.</p> <p>Setting: Set "ON" for "Resume Function" in the memory switch menu.</p>  |
| Screen print function       | <p>Functions:</p> <ul style="list-style-type: none"> <li>- Prints a hard copy of the screen display</li> <li>- Prints display/alarm histories</li> </ul> <p>Setting: Set the printing protocol ("Print Controller") and printing type ("Print Method") in the memory switch menu.</p> <p>"ESC/P", "Color": Color printing conforming to ESC/P 24-J83C</p> <p>"PC-PR201H", "Color": Color printing conforming to PC-PR201PL</p> <p>"ESC/P", "Tone": Monochrome printing in 8 grayscale levels, conforming to ESC/P 24-J82</p> <p>"PC-PR201H", "Tone": Monochrome printing in 8 grayscale levels, conforming to PC-PR201PL</p> <p>"PCL 5", "Tone": Monochrome printing in 8 grayscale levels, conforming to PCL 5</p> <p>However, the NT631 supports monochrome printing only.</p> |
| Calendar and clock function | <ul style="list-style-type: none"> <li>- Displays the current time in accordance with the built-in clock</li> <li>- Displayed and set with "Calendar Check" in the "MAINTENANCE MODE" menu</li> </ul>  |

| Item                         |                             | Specifications   |
|------------------------------|-----------------------------|--|
| Programming Console function |                             | Executes functions equivalent to those of a C200H-PRO27-E Programming Console for CPM1, CPM1A, CPM2A, CPM2C, CQM1 (-EV1 only), CQM1H, C200HX/HG/HE(-Z)E, and SRM1 (C02-V2 only) PLCs.<br>Executes functions as a Programming Console for CS/CJ-series PLC.   |
| Device Monitor function      |                             | The Device Monitor function can be used to change the PLC's operating mode, read/change words in the PLC's data areas, and display the PLC's error log. Compatible PLCs include the CPM1, CPM1A, CPM2A, CPM2C, CQM1, CQM1H, C200HX/HG/HE(-Z)E, SRM1, and CS/CJ-series PLCs.  |
| Mathematical function        |                             | Up to 256 calculation expressions can be registered along with the screen data. The mathematical function reads the required data from numeral memory tables or host words, executes the registered calculations, and writes the results. Arithmetic operators, logic operators, bit operators, and comparative operators can be used. |
| Transmission functions       | System program transmission | Downloads the system program from the system installer<br>Downloads/Upload the system program with a Memory Unit.  |
|                              | Screen data transmission    | - Function for downloading screen data to and uploading screen data from the Support Tool<br>- Function for transmitting screen data to and from the Memory Unit.  |
|                              | History data uploading      | Function for uploading display/alarm history data from PT.   |

## Communications Specifications

### For a Host Link, RS-232C

| Item                      | Specification  |
|---------------------------|--|
| Communications standard   | EIA RS-232C  |
| Communications settings   | Start-stop synchronization<br>Communications speed: 9600, 19200 bps<br>Data length: 7 bits<br>Stop bit: 2 bits<br>Parity: Even |
| Connector                 | 9-pin D-SUB connector (female) (serial port A, B)  |
| Number of Units connected | 1:1  |
| Transmission distance     | Max. 15 m*   |
| Communications protocol   | C-series SYSDWAY (1:N)   |

\* When using an NT-AL001, the specifications are as follows.

- RS-232C cable: Max. 2 m
- RS-422A cable: Total length 500 m max.

## For a Host Link, RS-422A

| Item                      | Specification  |
|---------------------------|--|
| Communications standard   | EIA RS-422A  |
| Communications settings   | Start-stop synchronization<br>Communications speed: 9600, 19200 bps<br>Data length: 7 bits<br>Stop bit: 2 bits<br>Parity: Even |
| Connector                 | Terminal Block (serial port B)   |
| Number of Units connected | 1:1  |
| Transmission distance     | Max. 500 m   |
| Communications protocol   | C-series SYSWAY (1:N)  |

## For an NT Link, 1:1, RS-232C

| Item                      | Specification                                     |
|---------------------------|---|
| Communications standard   | EIA RS-232C                                       |
| Connector                 | 9-pin D-SUB connector (female) (serial port A, B) |
| Number of Units connected | 1:1   |
| Transmission distance     | Max. 15 m*  |

\* When using an NT-AL001, the specifications are as follows.

- RS-232C cable: Max. 2 m
- RS-422A cable: Total length 500 m max.

## For an NT Link, 1:1, RS-422A

| Item                      | Specification                  |
|---------------------------|--------------------------------|
| Communications standard   | EIA RS-422A                    |
| Connector                 | Terminal block (serial port B) |
| Number of Units connected | 1:1                            |
| Transmission distance     | Max. 500 m                     |

## For an NT Link, 1:N, RS-232C

| Item                      | Specification                                     |
|---------------------------|---|
| Communications standard   | EIA RS-232C                                       |
| Connector                 | 9-pin D-SUB connector (female) (serial port A, B) |
| Number of Units connected | 1:1 to 8  |
| Transmission distance     | Max. 15 m*  |

\* To connect two or more PTs, NT-AL001 Adapters are required. When using an NT-AL001, the specifications are as follows.

- RS-232C cable: Max. 2 m
- RS-422A/485 cable: Total length 500 m max.

## For an NT Link, 1:N, RS-422A/485

| Item                      | Specification   |
|---------------------------|-----------------|
| Communications standard   | EIA RS-422A/485 |
| Connector                 | Terminal block  |
| Number of Units connected | 1:1 to 8        |
| Transmission distance     | Max. 500 m      |

## For a High-speed NT Link, 1:N, RS-232C

| Item                      | Specification                                     |
|---------------------------|---|
| Communications standard   | EIA RS-232C                                       |
| Connector                 | 9-pin D-SUB connector (female) (serial port A, B) |
| Number of Units connected | 1:1 to 8  |
| Transmission distance     | Max. 15 m*  |

\* To connect two or more PTs, NT-AL001 Adapters are required. When using an NT-AL001, the specifications are as follows.

- RS-232C cable: Max. 2 m
- RS-422A/485 cable: Total length 500 m max.

## For a High-speed NT Link, 1:N, RS-422A/485

| Item                      | Specification                  |
|---------------------------|--------------------------------|
| Communications standard   | EIA RS-422A/485                |
| Connector                 | Terminal block (serial port B) |
| Number of Units connected | 1:1 to 8                       |
| Transmission distance     | Max. 500 m                     |

## For a Memory Link, RS-232C

| Item                      | Specification  |
|---------------------------|--|
| Communications standard   | EIA RS-232C  |
| Communications settings   | Start-stop synchronization<br>Communications speed: 1200, 2400, 4800, 9600, 19200, 38400bps<br>Data length: 7, 8 bits<br>Stop bit: 1, 2 bits<br>Parity: None, even, odd<br>Flow control: None, RS/CS, XON/XOFF<br>Response: Presence/absence |
| Connector                 | 9-pin D-SUB connector (female) (serial port A, B)  |
| Number of Units connected | 1:1  |
| Transmission distance     | Max. 15 m*   |
| Communications protocol   | Memory link  |

\* When using NT-AL001, specification is as follows:

- RS-232C: Max. 2 m
- RS-422A: Max. total length 500 m

## For a Memory Link, RS-422A

| Item                      | Specification  |
|---------------------------|--|
| Communications standard   | EIA RS-422A  |
| Communications settings   | Start-stop synchronization<br>Communications speed: 1200, 2400, 4800, 9600, 19200, 38400 bps<br>Data length: 7, 8 bits<br>Stop bit: 1, 2 bits<br>Parity: None, even, odd<br>Flow control: None, XON/XOFF<br>Response: Presence/absence |
| Connector                 | Terminal block   |
| Number of Units connected | 1:1  |
| Transmission distance     | Max. 500 m*  |
| Communications protocol   | Memory link  |

## For a Bar Code Reader

| Item                      | Specification   |
|---------------------------|---|
| Communications standard   | EIA RS-232C   |
| Communications settings   | Start-stop synchronization<br>Communications speed: 4,800, 9600, 19200 bps<br>Data length: 7, 8 bits<br>Stop bit: 1, 2 bits<br>Parity: None, even, odd<br>Flow control: RS/CS |
| Connector                 | 9-pin D-SUB connector (female) (serial port A)  |
| Number of Units connected | 1:1   |
| Transmission distance     | Max. 15 m   |
| Communications protocol   | Non-protocol mode   |
| Data format               | [STX] Data (0 to 40 bytes) [ETX]  |





# Appendix B

## Dimensions

### Body

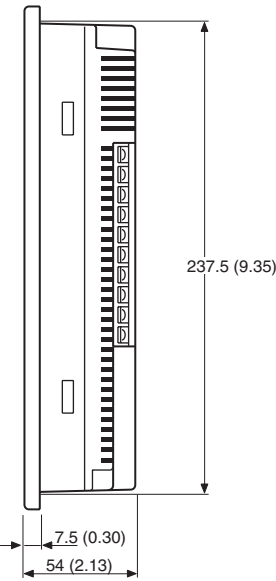
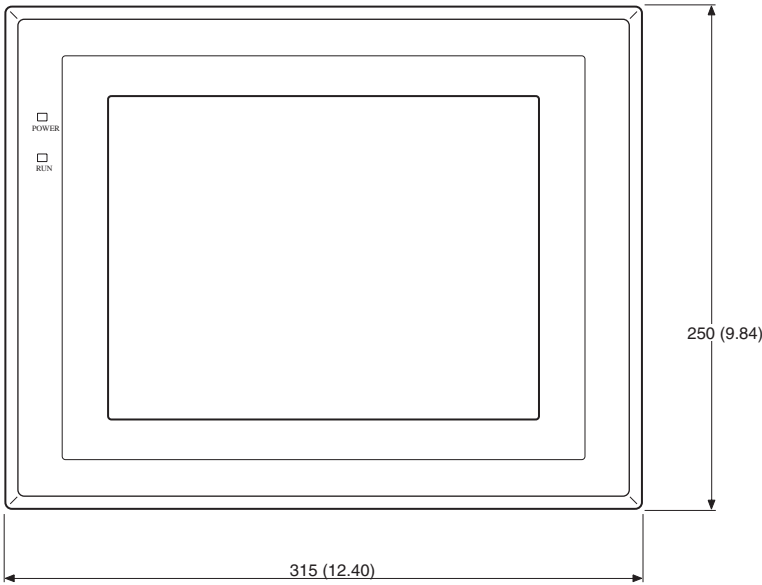
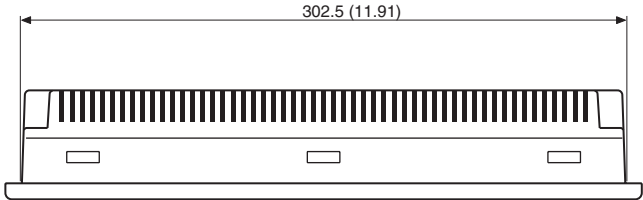

Units: mm (inch)

With memory unit installed (NT-MF261)

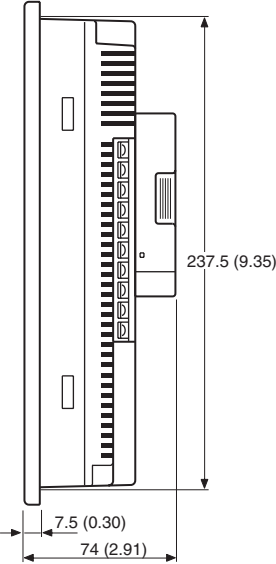

### Mounting Dimensions

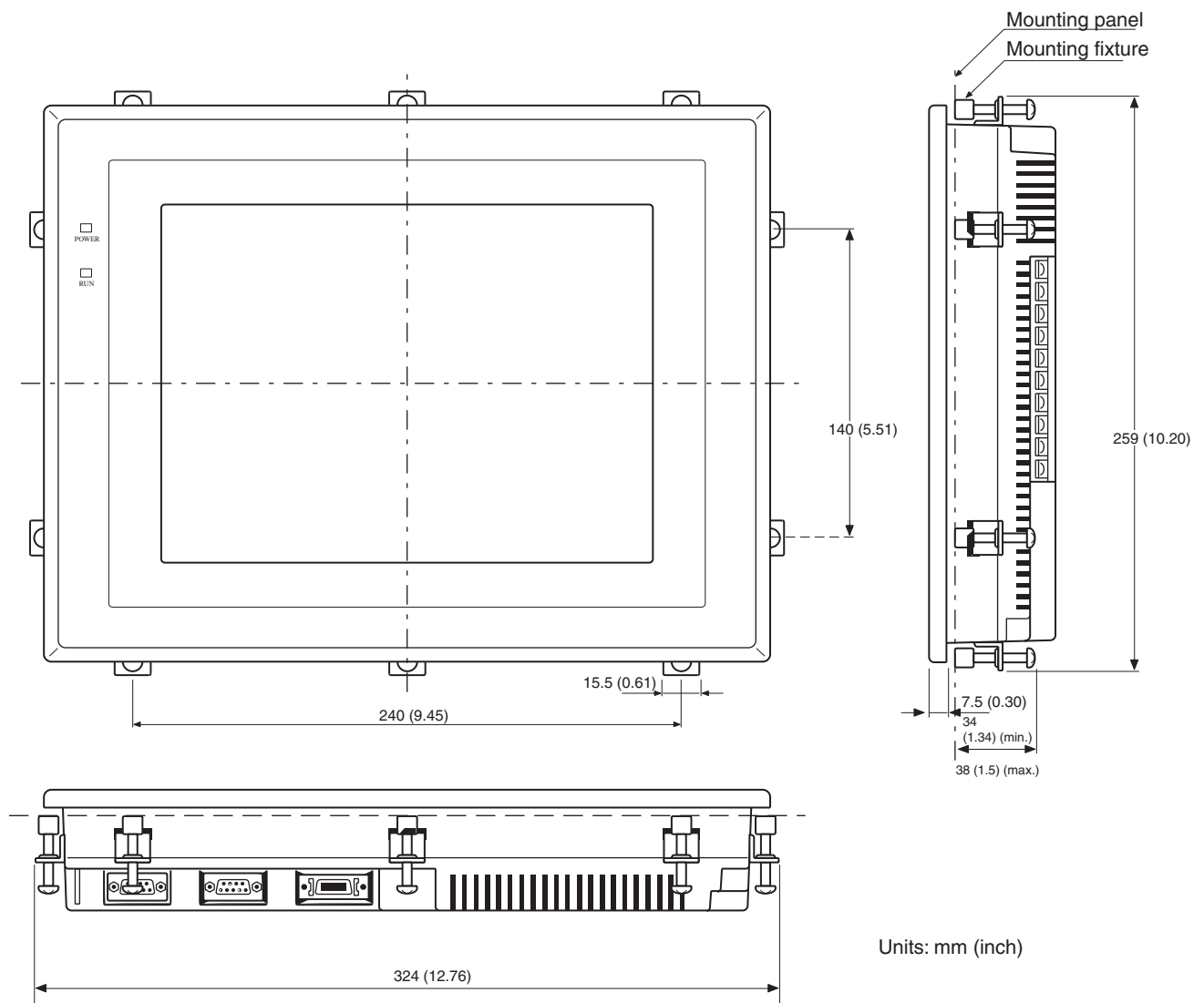

### Cable Connection Dimensions (with NT-MF261)

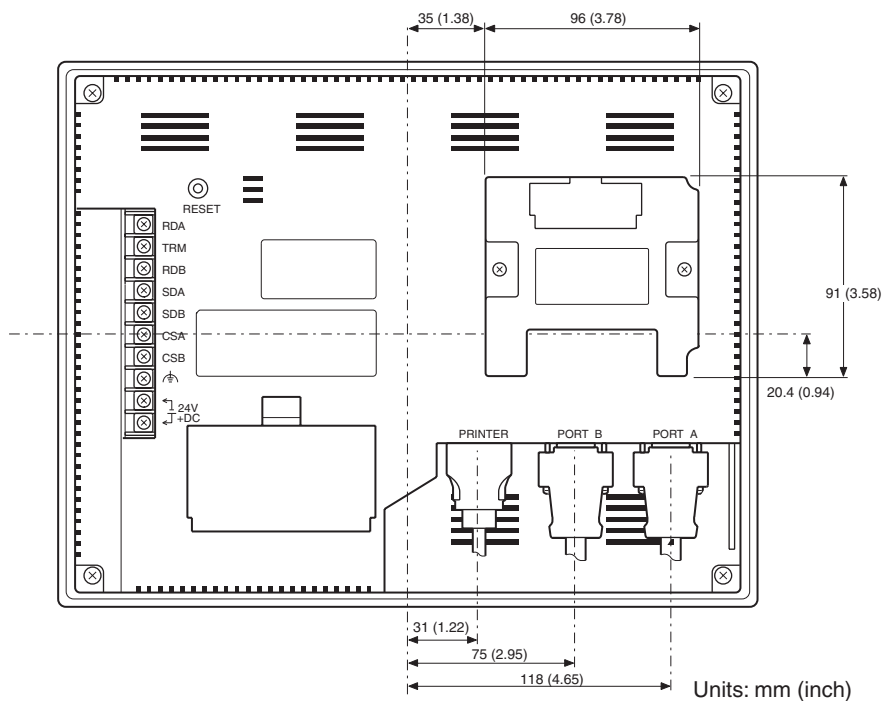



# Appendix C

## Using an RS-232C/RS-422A Adapter

This section outlines the external dimensions, procedure for mounting and removal, and specifications of an RS-232C/RS-422A Adapter (NT-AL001-E). Refer to this information when designing the control panel. For details, refer to the instruction manual supplied with the NT-AL001-E.

### Dimensions

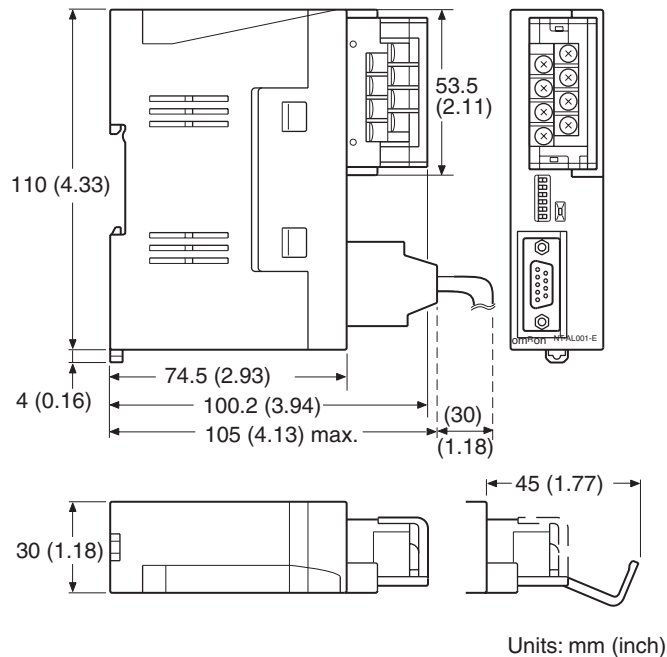

30 (W) × 114 (H) × 100.2 (D) mm: with the RS-422A terminal block cover closed

30 (W) × 114 (H) × 119.5 (D) mm: with the RS-422A terminal block cover open

### Methods for Mounting and Removal

The RS-232/RS-422 Adapter (NT-AL001-E) can be mounted on a DIN rail or in an operation panel.

The RS-422A terminal block of the Adapter can be easily removed.

#### Mounting to a DIN Rail

Latch the top part of the rear face of the Adapter (a in the figure) onto the top edge of the DIN rail, and push the PT in the direction indicated by b in the figure.

Now fit end plates at the right and left of the Adapter to secure it and ensure that it cannot shift laterally.

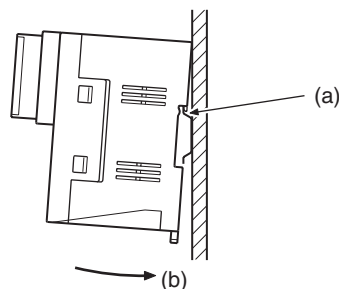

## Removal from a DIN Rail

Remove the end plates at right and left of the Adapter and, as shown in the figure below, insert a flat-blade screwdriver into the rail stopper at the bottom face of the Adapter and pry it free.

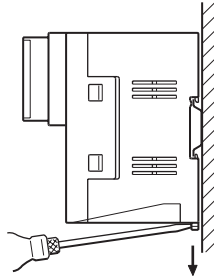

## Mounting to an Operation Panel

Drill two mounting screw holes in an operation panel with a thickness of at least 2 mm (0.08 inch) and secure the Adapter with screws.

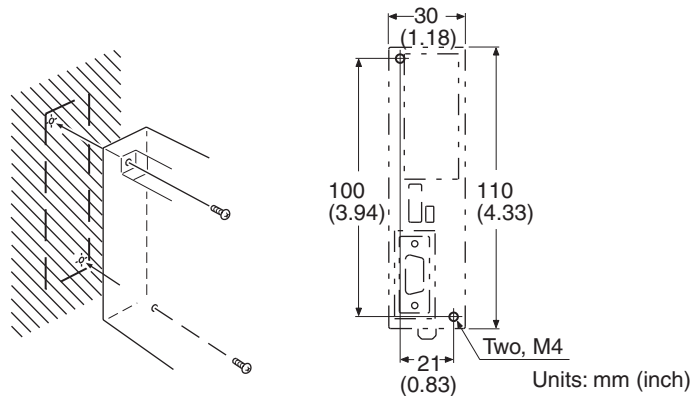

**Note** In order to ensure a secure and strong mount, mount the Adapter in an operation panel with a thickness of at least 2 mm (0.08 inch).

## Specifications

The general specifications and communications specifications of the Adapter are shown below.

### General Specifications

| Item                          | Specification  |
|-------------------------------|--|
| Dimensions                    | 30 (W) × 114 (H) × 100.2 (D) mm: with the RS-422A terminal block cover closed<br>30 (W) × 114 (H) × 119.5 (D) mm: with the RS-422A terminal block cover open |
| Weight                        | 200 g max.   |
| Operating ambient temperature | 0 to 55°C  |
| Operating ambient humidity    | 10 to 90% RH (with no condensation)  |
| Rated power supply voltage    | +5 V ± 10% (using pin No. 6 of the RS-232C connector)  |
| Rated power supply current    | 150 mA max.  |
| Rush current                  | 0.8 A max.   |
| Insulation resistance         | 20 MΩ or higher, measured between all RS-422A terminal signal lines collectively and functional ground terminal at 500 VDC                                   |
| Dielectric strength           | 1500 VAC for 1 minute between all RS-422A terminal signal lines collectively and functional ground terminal<br>Leakage current: 10 mA max.                   |
| Operating environment         | No corrosive gases   |
| Storage ambient temperature   | -20 to +75°C   |
| Vibration resistance          | 10 to 57 Hz with 0.075-mm single amplitude and 57 to 150 Hz at 9.8 m/s <sup>2</sup> for 60 minutes each in X, Y, and Z directions                            |
| Shock resistance              | 147 m/s <sup>2</sup> 3 times each in X, Y, and Z directions  |

### Communications Specifications

#### RS-232C Interface

| Item                  | Specification                  |
|-----------------------|--------------------------------|
| Communications speed  | Max. 64k bps                   |
| Transmission distance | Max. 2 m                       |
| Connector             | 9-pin D-SUB connector (female) |

#### RS-422A/485 Interface

| Item                  | Specification  |
|-----------------------|--|
| Communications speed  | Max. 64k bps (depends on the RS-232C communications speed) |
| Transmission distance | Max. 500 m   |
| Connector             | 8-terminal detachable terminal block, M3.0                 |

### DIP Switch Settings

The Adapter has 6 digits DIP switch for setting the RS-422A/485 communications conditions.

Before connecting the cable to the Adapter, make the DIP switch settings.

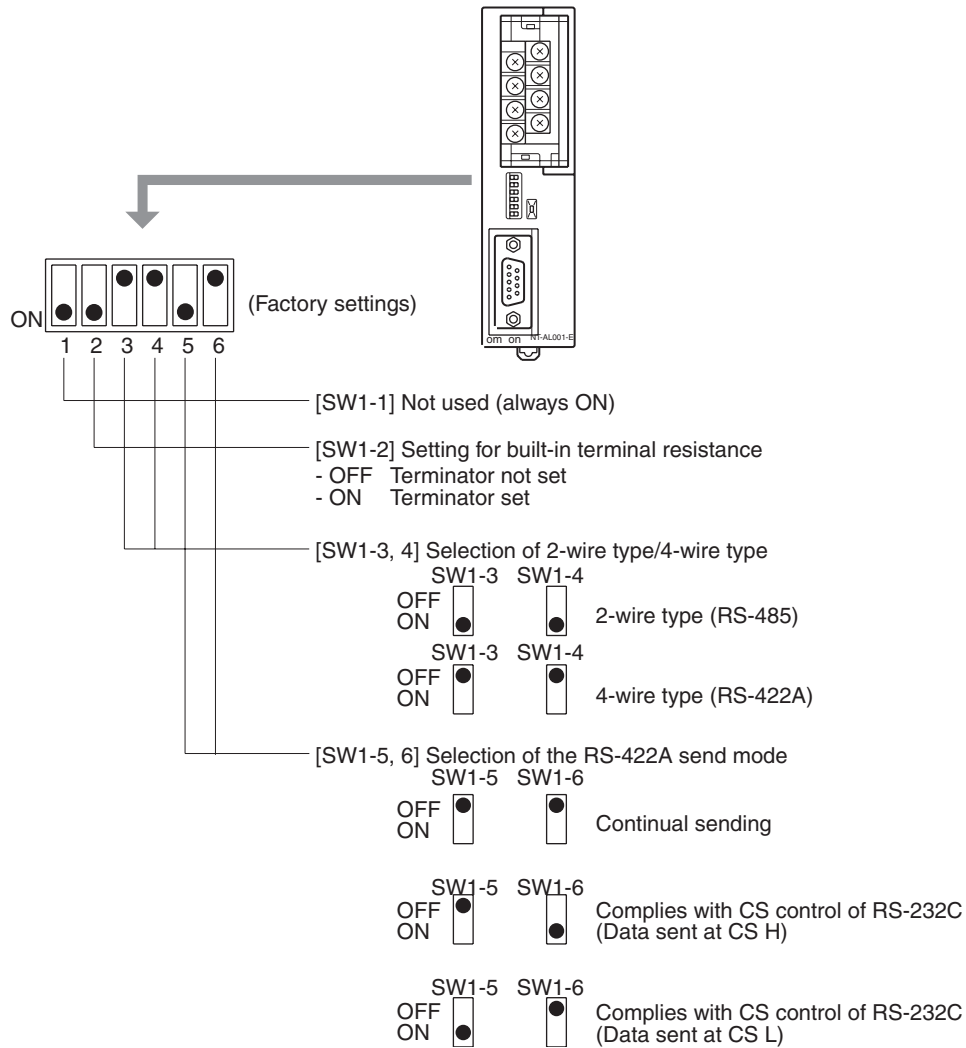

When using the host link or NT link (1:1), set the RS-422A send mode to continual sending (set both SW1-5 and 6 OFF).

When using the NT link (1:N), set the RS-422A send mode to complies with CS control of RS-232C (i.e., one of SW1-5 and SW1-6 must be ON).

- Note**
- (1) Do not set both SW1-5 and SW1-6 ON at the same time. This may damage internal circuits.
  - (2) The power supply to the device supplying +5 V must be turned OFF before starting wiring work.
  - (3) Before connecting the RS-232C cable and turning on the power to an RS-232C device such as a PT (i.e., turning on the power to the Adapter), check that the cable is wired correctly and that the DIP switch settings are correct. If the power is turned on while there is a wiring fault, the internal circuits of the Adapter or the RS-232C device may be damaged.
  - (4) When the Adapter is connected to an OMRON C200HX/HG/HE(-Z)E, CQM1H, or CS/CJ-series PLC as an RS-422A device, set DIP switches SW1-5 and SW1-6 as indicated below.

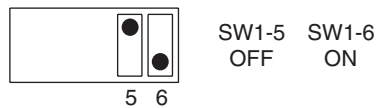



## Pin Arrangement

The Adapter has a terminal block for an RS-422A/485 interface connection and a connector for an RS-232C interface connection.

The pin arrangements for the RS-422A/485 terminal block and the RS-232C connector are as follows.

### RS-422A/485 Terminal Block

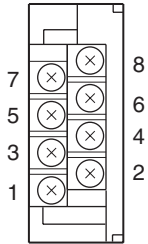

| Terminal block pin No. | Signal name         | Abbreviation | Signal direction (Adapter ↔ RS-422 device) |
|------------------------|---------------------|--------------|--|
| 8                      | Request to send (-) | CSA          | →  |
| 7                      | Request to send (+) | CSB          | →  |
| 6                      | Receive data (-)    | RDA          | ←  |
| 5                      | Receive data (+)    | RDB          | ←  |
| 4                      | Send data (-)       | SDA          | →  |
| 3                      | Send data (+)       | SDB          | →  |
| 2                      | Signal ground       | SG (GND)     | -  |
| 1                      | Functional ground   |              | -  |

\* The CSB and CSA signals are for specialized applications.

### RS-232C Connector

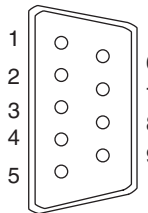

| Connector pin No. | Signal name                                    | Abbreviation | Signal direction (Adapter ↔ RS-232C device) |
|-------------------|--|--------------|---|
| 1                 | Not used                                       | -            | -   |
| 2                 | Send data                                      | SD           | ←   |
| 3                 | Receive data                                   | RD           | →   |
| 4                 | Request to send (shorted to CS internally)     | RS           | ←   |
| 5                 | Clear to send (shorted to RS internally)       | CS           | →   |
| 6                 | +5 V (150 mA) input for Adapter                | +5 V         | →   |
| 7                 | Data set ready (shorted to ER internally)      | DR           | →   |
| 8                 | Data terminal ready (shorted to DR internally) | ER           | ←   |
| 9                 | Signal ground                                  | SG           | -   |

\* The hood is connected to the functional ground terminal of the RS-422A terminal block.

# Block Diagram

A diagram showing the internal blocks of the Adapter is shown below. Refer to this diagram when making cables yourself, or when connecting devices with special interfaces.

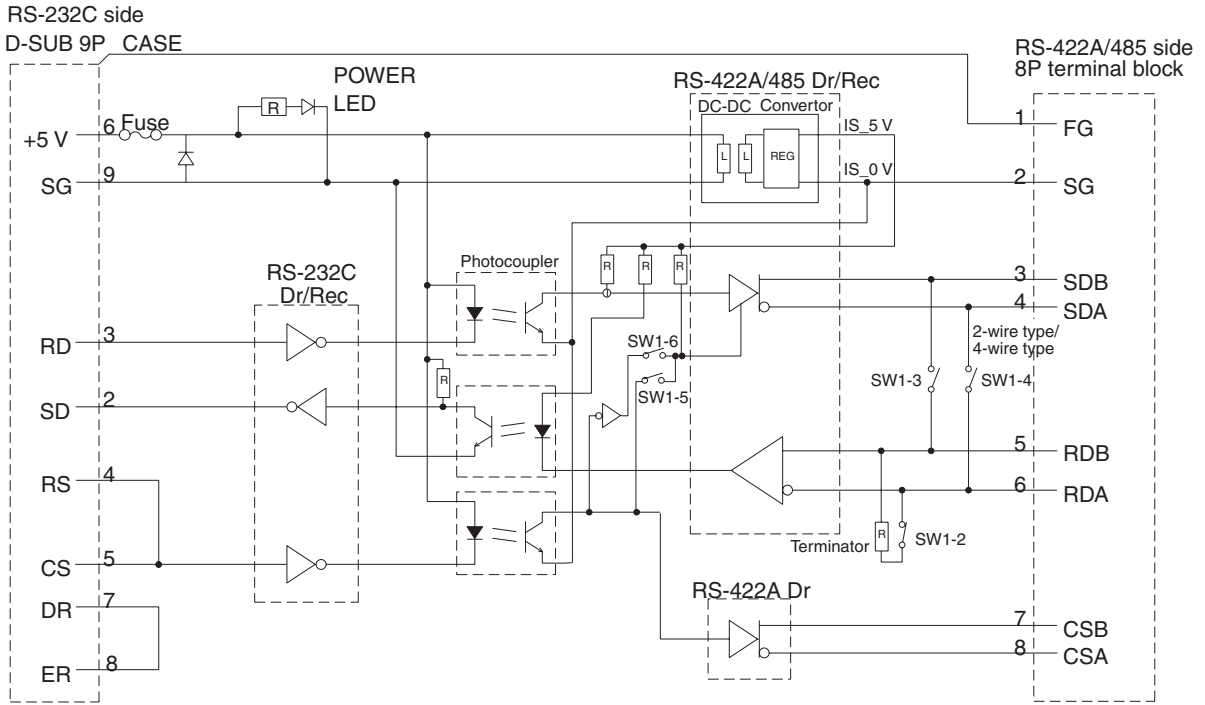

# Appendix D

## Transporting and Storing the NT631/NT631C

- When transporting the NT631/NT631C, use the packaging intended for it.
- When storing the NT631/NT631C, observe the following conditions.
  - Storage ambient temperature:  $-20$  to  $+60^{\circ}\text{C}$
  - Storage ambient humidity: 35% to 85%



# Appendix E

## Making the Cable

The procedure for making up the cable is described below.

Also refer to this procedure for making a connecting cable for use with RS-422A/485 connections.

### Cable Preparation

The preparation of the cable differs according to whether or not the shielding wire is to be connected to the FG.

#### Cable with Shielding Wire Connected to FG

**1,2,3...**

1. Cut the cable to the required length.
2. Remove the external vinyl insulation from the cable with a razor blade. Take care not to damage the shielding underneath.
3. Cut back the shielding wire with scissors.
4. Use wire strippers to strip the insulation from each wire.
5. Fold back the shielding wire.
6. Wrap aluminum foil tape around the folded-back shielding wire.

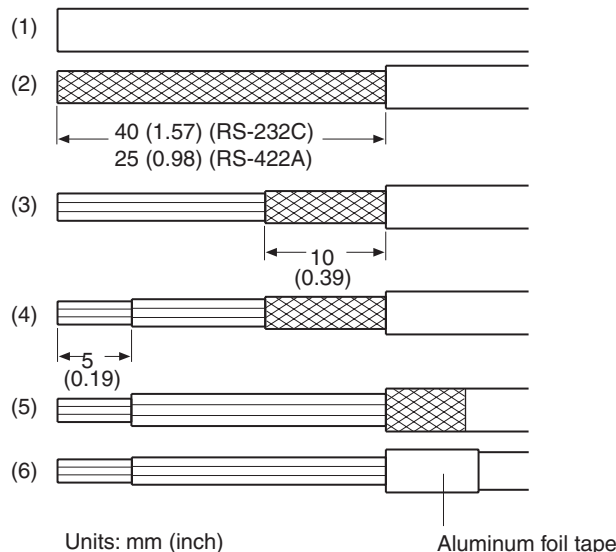

#### Cable with Shielding Wire Not Connected to FG

**1,2,3...**

1. Cut the cable to the required length.
2. Remove the external vinyl insulation from the cable with a razor blade. Take care not to damage the shielding underneath.
3. Cut back the shielding wire with scissors.
4. Use wire strippers to strip the insulation from each wire.
5. Wrap vinyl tape over the cut off end of the shielding wire.

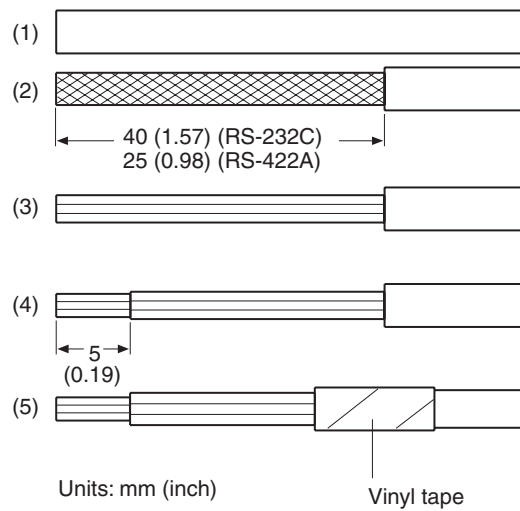

## Soldering

### 1,2,3...

1. Slide heat-shrink tube over each wire.
2. Pre-solder each wire and connector terminal.
3. Solder each wire to each connector terminal.

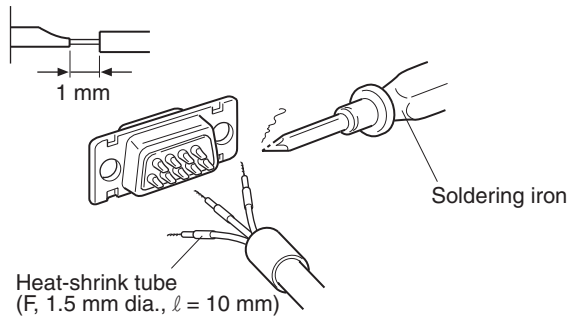

4. Push the heat shrink tube over the soldered joint and heat the tube to shrink it in place.

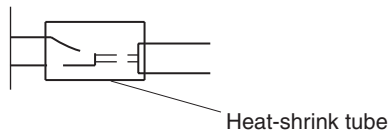

## Hood Assembly

Assemble the connector hood as shown below.

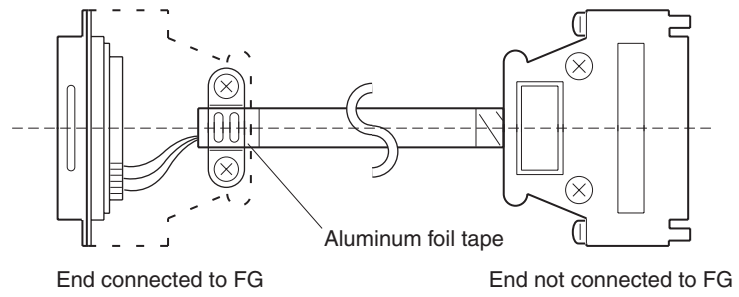





# Appendix F

## Making the Cable for Connecting a PLC

Refer to the following when making a cable for connecting the Support Tool.

### Assembly of Connecting Cables

Wiring should be carried out in one of the following ways, depending on the type of RS-232C connector.

#### 25-pin Connector

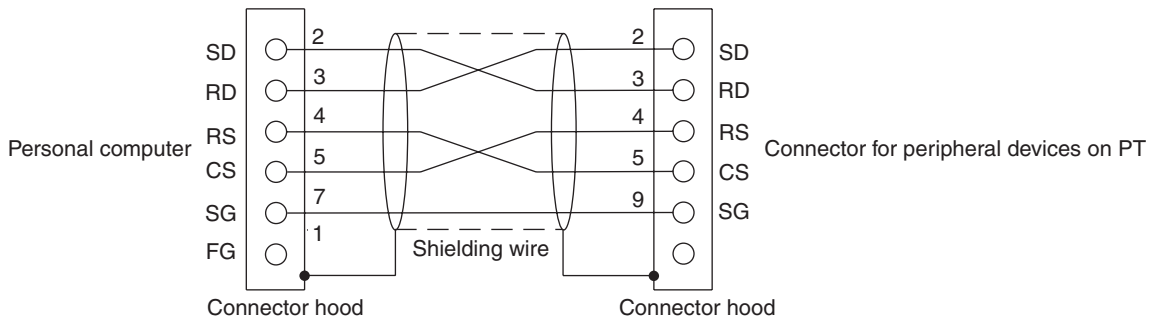

**Note** Connect a shielding wire to the connector hood of the connectors both at the personal computer end and the PT end.

Use the following recommended products when making the connecting cable.

| Name           | Model                | Remarks  |
|----------------|----------------------|--|
| Connector      | XM2D-2501            | 25-pin, made by OMRON, for personal computer side      |
|                | XM2A-0901            | 9-pin, made by OMRON, for PT side                      |
| Connector hood | XM2S-2511            | 25-pin, made by OMRON, for personal computer side      |
|                | XM2S-0911            | 9-pin, made by OMRON, for PT side                      |
| Cable          | AWG28×5P IFVV-SB     | Multi-core shielded cable, made by Fujikura Ltd.       |
|                | CA-MA-VV-SB 5P×28AWG | Multi-core shielded cable, made by Hitachi Cable, Ltd. |

#### 9-pin Connector

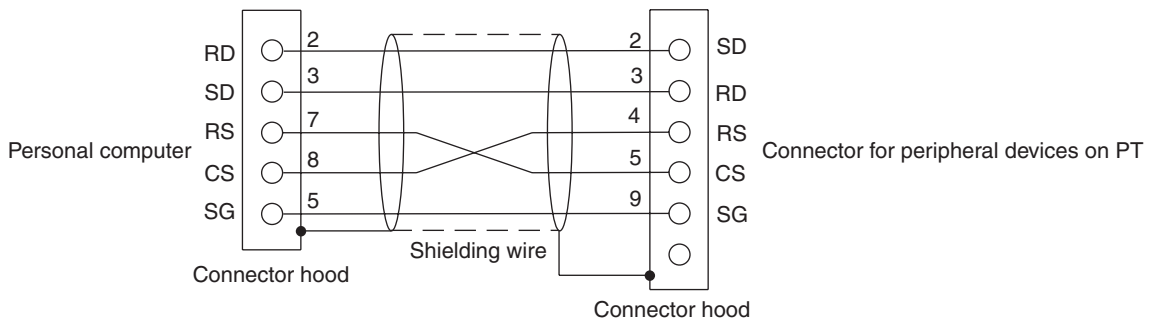

**Note** Connect a shielding wire to the connector hood of the connectors both at the personal computer end and the PT end.

Use the following recommended products when making the connecting cable.

| <b>Name</b>     | <b>Model</b>         | <b>Remarks</b>   |
|-----------------|----------------------|--|
| Connector       | XM2D-0901            | 9-pin, made by OMRON, for personal computer            |
|                 | XM2A-0901            | 9-pin, made by OMRON, for PT                           |
| Connector hood* | XM2S-0911            | 9-pin, mm pitch screw, made by OMRON                   |
|                 | XM2S-0913            | 9-pin, inch pitch screw, made by OMRON                 |
| Cable           | AWG28×5P IFVV-SB     | Multi-core shielded cable, made by Fujikura Ltd.       |
|                 | CA-MA-VV-SB 5P×28AWG | Multi-core shielded cable, made by Hitachi Cable, Ltd. |

\* One XM2S-0911 (for PT) and either one XM2S-0911 or -0913 (for your personal computer) are needed.

# Appendix G

## Making the Cable for Connection to a Bar Code Reader

### Code Reader

Refer to the following when making the cable for connection to a bar code reader.

### Wiring Method

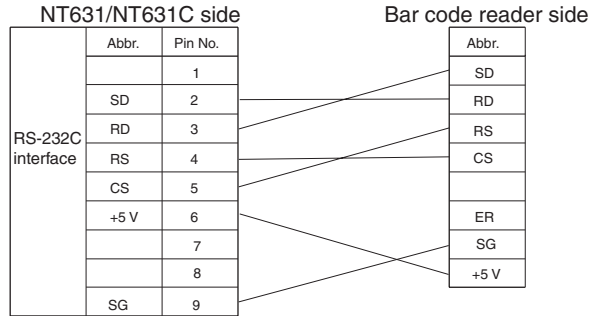

When using the +5 V output of serial port A of the NT631/NT631C, limit the cable length to within 2 m. If a cable longer than 2 m is used, connect an external power supply to the bar code reader.

### Connector and Related Parts

Use the parts which are specified by bar code reader and following recommended products when making the connecting cable.

| Name           | Model                | Remarks  |
|----------------|----------------------|--|
| Connector      | XM2A-0901            | 9-pin type, made by OMRON, PT side                     |
| Connector hood | XM2S-0911            | 9-pin, made by OMRON                                   |
| Cable          | AWG28×5P IFVV-SB     | Multi-core shielded cable, made by Fujikura Ltd.       |
|                | CA-MA-VV-SB 5P×28AWG | Multi-core shielded cable, made by Hitachi Cable, Ltd. |



# Appendix H

## Making the Cable for Connection to a Printer

The following product is recommended as the cable for connecting a printer.

NT-CNT121 (made by OMRON, cable length 1.5 m, 20-pin – 36-pin)

Refer to the following when making a cable for connection to a printer.

- Connector pin arrangement and wiring

Connector for a printer  
on PT side

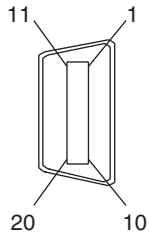

| Abbr. | Pin No.        | Shielding wire | Pin No.        |
|-------|----------------|----------------|----------------|
|       | Connector hood |                | Connector hood |
| 0 V   | 1              |                | 20             |
| D7    | 11             |                | 9              |
| N.C.  | 2              |                | N.C.           |
| D6    | 12             |                | 8              |
| D5    | 3              |                | 7              |
| 0 V   | 13             |                | 21             |
| D4    | 4              |                | 6              |
| N.C.  | 14             |                | N.C.           |
| D3    | 5              |                | 5              |
| 0 V   | 15             |                | 22             |
| 0 V   | 6              |                | 23             |
| D2    | 16             |                | 4              |
| N.C.  | 7              |                | N.C.           |
| D1    | 17             |                | 3              |
| D0    | 8              |                | 2              |
| 0 V   | 18             |                | 24             |
| STROB | 9              |                | 1              |
| N.C.  | 19             |                | N.C.           |
| BUSY  | 10             |                | 11             |
| 0 V   | 20             |                | 19             |

Printer side

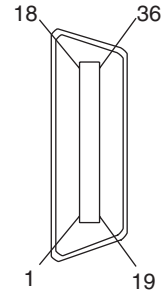



# Appendix I

## Relationship between system program and hardware

Here, relationship between system program and hardware is described.

System programs indicated below are installed for the models shown above in the default state. Also, system programs are supplied with the Support Tool as follows.

| Model             | History   | System program   |  |
|-------------------|---|--|--|
| NT631-ST211□-E    | Conventional product                                      | System Program version 1.□<br>(supplied with the NT-ZJCMX1-EV2)            | Same for pre-version-1 and version-2 hardware, but there are restrictions to some functions depending on the hardware version that is installed. |
| NT631C-ST141□-E   |   |  |  |
| NT631C-ST151□-E   |   |  |  |
| NT631-ST211□-EV1  | Version upgrade of the above products<br>(December 1998)  | System Program version 2.0□ or 2.1□<br>(supplied with the NT-ZJCMX1-EV3)   |  |
| NT631C-ST141□-EV1 |   |  |  |
| NT631C-ST151□-EV1 |   |  |  |
| NT631-ST211□-EV2  | Version upgrade of the above products<br>(December 1999)  | System Program version 3.0□ or 3.1□<br>(supplied with the NT-ZJCMX1-V4.00) |  |
| NT631C-ST141□-EV2 |   |  |  |
| NT631C-ST151□-EV2 |   |  |  |
| NT631C-ST152□-EV2 | Version upgrade of the above products<br>(October 2004)   | System Program version 3.1□<br>(supplied with the NT-ZJCMX1-V4.05)         |  |
| NT631C-ST153□-EV3 | Version upgrade of the above products<br>(September 2006) | System Program version 4.1□<br>(supplied with the NT-ZJCMX1-V4.08)         | Only for hardware for version-3 (EV3) PTs. Cannot be installed with pre-version-1 or version-2 hardware.   |

**Note** NT System Installer version 2.0 or higher is required to transfer the NT631-EV3-compatible system program. (NT System Installer version 2.0 is provided with the NT-series Support Tool version 4.08 or higher.)

These system programs have mutual compatibility, therefore, they can be installed and used for NT631-ST211□-E/NT631C-ST141-E/NT631C-ST151□-E, NT631-ST211□-EV1/NT631C-ST141□-EV1/NT631C-ST151□-EV1, and NT631-ST211□-EV2/NT631C-ST141□-EV2/NT631C-ST151□-EV2/NT631C-ST152□-EV2 each.

However, there will be a limitation on function depending on the combination. Refer to the following table.

System program version 4.0□ is only for NT631C-ST153□-EV3. The system program cannot be installed in pre-version-2 hardware. System program earlier than Ver. 3.1□ cannot be installed in NT631C-ST153□-EV3.

The following table shows only the relationship between the hardware and system program.

For details of the relationship with the screen data created using the Support Tool, refer to *NT-series Support Tool for Windows (Ver. 4.□) Operation Manual (V061-E1-□)*.

## Combining a -EV1 Version and Version without a -EV□ Suffix

|                                       | Hardware  |  |
|---------------------------------------|---|--|
|                                       | NT631-ST211□-E<br>NT631C-ST141□-E<br>NT631C-ST151□-E  | NT631-ST211□-EV1<br>NT631C-ST141□-EV1<br>NT631C-ST151□-EV1   |
| System program Ver. 1.0□              | The following functions can not be used: <ul style="list-style-type: none"> <li>• Analogue meter</li> <li>• High-definition font display</li> <li>• Installation of system programs using Memory Unit</li> <li>• Connection to Mitsubishi PLCs</li> <li>• Memory link</li> <li>• Window control from the host</li> <li>• Multiple display of window screens</li> <li>• Moving a window</li> <li>• Refer to the following table for details on new functions supported by the -V2 versions.</li> </ul> | The following functions can not be used: <ul style="list-style-type: none"> <li>• Analogue meter</li> <li>• High-definition font display</li> <li>• Connection to Mitsubishi PLCs</li> <li>• Memory link</li> <li>• Window control from the host</li> <li>• Multiple display of window screens</li> <li>• Moving a window</li> <li>• Refer to the following table for details on new functions supported by the -V2 versions.</li> <li>* Installation of system programs using Memory Unit is possible.</li> </ul> |
| System program Ver. 2.0□ or Ver. 2.1□ | The following functions can not be used: <ul style="list-style-type: none"> <li>• Installation of system programs using Memory Unit</li> <li>• High-definition font display</li> <li>• Refer to the following table for details on new functions supported by the -V2 versions.</li> </ul>  | The new functions supported by the -V2 versions cannot be used. Refer to the following table for details.  |

\* The system program's version can be checked from the System Menu.

## Combining a -EV1 Version and -EV2 Version

|                                       | Hardware  |  |
|---------------------------------------|---|--|
|                                       | NT631-ST211□-EV1<br>NT631C-ST141□-EV1<br>NT631C-ST151□-EV1  | NT631-ST211□-EV2<br>NT631C-ST141□-EV2<br>NT631C-ST151/152□-EV2 |
| System program Ver. 2.0□ or Ver. 2.1□ | The following functions (new functions supported by the -V2) cannot be used: <ul style="list-style-type: none"> <li>• Additional data areas accessible in CS/CJ-series PLCs</li> <li>• The CS/CJ-series high-speed 1:N NT Link</li> <li>• Interlock function that controls touch switches, numeral inputs, and character string inputs</li> <li>• Mathematical function</li> <li>• Device Monitor function</li> <li>• NT30/620 compatible mode</li> <li>• Expanded capabilities for label (guide character) displays, including multiple lines of text, ON/OFF switching displays, numeral memory table displays, and character string memory table displays</li> </ul> |  |
| System program Ver. 3.0□              | All of the functions described in the Setup Manual and Reference Manual can be used.  |  |

\* The system program's version can be checked from the System Menu.



### Combining a -EV2 Version and Version without a -EV□ Suffix

|                          | Hardware   |  |
|--------------------------|--|--|
|                          | NT631-ST211□-E<br>NT631C-ST141□-E<br>NT631C-ST151□-E   | NT631-ST211□-EV2<br>NT631C-ST141□-EV2<br>NT631C-ST151/152□-EV2   |
| System program Ver. 1.0□ | The following functions cannot be used: <ul style="list-style-type: none"> <li>• Analogue meter</li> <li>• High-definition font display</li> <li>• Installation of system programs using Memory Unit</li> <li>• Connection to Mitsubishi PLCs</li> <li>• Memory link</li> <li>• Window control from the host</li> <li>• Multiple display of window screens</li> <li>• Moving a window</li> <li>• Additional data areas accessible in CS/CJ-series PLCs</li> <li>• The CS/CJ-series high-speed 1:N NT Link</li> <li>• Interlock function that controls touch switches, numeral inputs, and character string inputs</li> <li>• Mathematical function</li> <li>• Device Monitor function</li> <li>• NT30/620 compatible mode</li> <li>• Expanded capabilities for label (guide character) displays, including multiple lines of text, ON/OFF switching displays, numeral memory table displays, and character string memory table displays</li> </ul> | The following functions cannot be used: <ul style="list-style-type: none"> <li>• Analogue meter</li> <li>• High-definition font display</li> <li>• Connection to Mitsubishi PLCs</li> <li>• Memory link</li> <li>• Window control from the host</li> <li>• Multiple display of window screens</li> <li>• Moving a window</li> <li>• Additional data areas accessible in CS/CJ-series PLCs</li> <li>• The CS/CJ-series high-speed 1:N NT Link</li> <li>• Interlock function that controls touch switches, numeral inputs, and character string inputs</li> <li>• Mathematical function</li> <li>• Device Monitor function</li> <li>• NT30/620 compatible mode</li> <li>• Expanded capabilities for label (guide character) displays, including multiple lines of text, ON/OFF switching displays, numeral memory table displays, and character string memory table displays</li> </ul> * Installation of system programs using Memory Unit is possible. |
| System program Ver. 3.0□ | The following functions can not be used: <ul style="list-style-type: none"> <li>• Installation of system programs using Memory Unit</li> <li>• High-definition font display</li> </ul>   | All of the functions described in the Setup Manual and Reference Manual can be used.   |

\* The system program's version can be checked from the System Menu.



# Appendix J

## Model List

### PTs

| Model             | Specification                             |
|-------------------|---|
| NT631-ST211-EV2   | High-intensity EL display (yellow), beige |
| NT631-ST211B-EV2  | High-intensity EL display (yellow), black |
| NT631C-ST141-EV2  | STN color display, beige                  |
| NT631-ST141B-EV2  | STN color display, black                  |
| NT631C-ST153-EV3  | High-intensity STN color display, beige   |
| NT631C-ST153B-EV3 | High-intensity STN color display, black   |

### Host Link Units

| Model           | Specification  | Applicable PLC                                      |
|-----------------|--|---|
| 3G2A6-LK201-EV1 | CPU-mounting Unit with RS-232C connector   | C-series<br>C1000H<br>C2000H                        |
| 3G2A6-LK202-EV1 | CPU-mounting Unit with RS-422A connector   |   |
| C200H-LK201-V1  | Rack-mounting Unit with RS-232C connector for C200H  | C-series<br>C200HS<br>C200HX/HG/HE(-Z)E             |
| C200H-LK202-V1  | Rack-mounting Unit with RS-422A connector for C200H  |   |
| 3G2A5-LK201-EV1 | Features a selectable RS-232C/RS-422A connector  | C-series<br>C1000H<br>C2000H                        |
| C500-LK203      | Rack-mounting Unit for C500  | C-series<br>C1000H(F)<br>C2000H                     |
| CV500-LK201     | Features an RS-232C connector and a selectable RS-232C/<br>RS-422A connector<br>Rack-mounting Unit for CVM1/CV | CVM1/CV-series<br>CV500<br>CV1000<br>CV2000<br>CVM1 |

### CompoBus/S Master Control Unit

| Model       | Specification            | Model Name |
|-------------|--------------------------|------------|
| SRM1-C02-V2 | Features an RS-232C port | SRM1       |

### Communications Unit

| Model           | Specification                               | Applicable PLC        |
|-----------------|---|-----------------------|
| CS1W-SCU21(-V1) | RS-232C (2 ports)<br>Rack-mounting Unit     | CS-series<br>CS1G/H/D |
| CS1W-SCU31-V1   | RA-422A/485 (2 ports)<br>Rack-mounting Unit |                       |
| CJ1W-SCU21(-V1) | RS-232C (2 ports)                           | CJ-series<br>CJ1G/H/M |
| CJ1W-SCU31-V1   | RA-422A/485 (2 ports)                       |                       |
| CJ1W-SCU41(-V1) | RS-232C (1 port)<br>RA-422A/485 (1 port)    |                       |

## CPU Units for Connection via a Host Link

| Model  | Specification  | PLC Type  |
|--|--|---|
| CPM1-10CDR-□<br>CPM1-20CDR-□<br>CPM1A-10CD□-□<br>CPM1A-20CD□-□<br>CPM1A-30CD□-□<br>CPM1A-40CD□-□   | RS-232C adapter/RS-422A adapter connected to the peripheral port   | C-series<br>CPM1                                    |
| CPM2A-30CD□□-□<br>CPM2A-40CD□□-□<br>CPM2A-60CD□□-□   | Features a 9-pin connector for RS-232C connections   | C-series<br>CPM2A                                   |
| CPM2C-10□□□□□□-□<br>CPM2C-20□□□□□□-□   | The PLC's communications connector can be split into an RS-232C port and peripheral port with a CPM2C-CN111 Connecting Cable. (The CS1W-CN114/118 Connecting Cables convert the connector to a single RS-232C or peripheral port.) | C-series<br>CPM2C                                   |
| CQM1-CPU21-E<br>CQM1-CPU41-EV1<br>CQM1-CPU42-EV1<br>CQM1-CPU43-EV1<br>CQM1-CPU44-EV1<br>CQM1-CPU45-EV1   | Features a 9-pin connector for RS-232C connections   | C-series<br>CQM1                                    |
| CQM1H-CPU11<br>CQM1H-CPU21<br>CQM1H-CPU51<br>CQM1H-CPU61   | Features a 9-pin connector for RS-232C connections<br>(The CQM1H-CPU11-E has only a peripheral port.)  | C-series<br>CQM1H                                   |
| C200HS-CPU21-E<br>C200HS-CPU23-E<br>C200HS-CPU31-E<br>C200HS-CPU33-E   | Features a connector for RS-232C connections (selectable/<br>9-pin)  | C-series<br>C200HS                                  |
| C200HE-CPU32-(Z)E <sup>(*)</sup><br>C200HE-CPU42-(Z)E  | Features a connector for RS-232C connections (selectable/<br>9-pin)  | C-series<br>C200HE-(Z)E                             |
| C200HG-CPU33-(Z)E <sup>(*)</sup><br>C200HG-CPU43-(Z)E<br>C200HG-CPU53-(Z)E <sup>(*)</sup><br>C200HG-CPU63-(Z)E                                       | Features a connector for RS-232C connections (selectable/<br>9-pin)  | C-series<br>C200HG-(Z)E                             |
| C200HX-CPU34-(Z)E <sup>(*)</sup><br>C200HX-CPU44-(Z)E<br>C200HX-CPU54-(Z)E <sup>(*)</sup><br>C200HX-CPU64-(Z)E<br>C200HX-CPU65-ZE<br>C200HX-CPU85-ZE | Features a connector for RS-232C connections (selectable/<br>9-pin)  | C-series<br>C200HX-(Z)E                             |
| CS1G-CPU42/43/44/45-E(V1)<br>CS1H-CPU63/64/65/66/67-E(V1)<br>CS1G-CPU42H/43H/44H/45H<br>CS1H-CPU63H/64H/65H/66H/67H<br>CS1D-CPU65H/67H               | Features a connector for RS-232C connections (9-pin)   | CS-series<br>CS1G/H/D                               |
| CJ1G-CPU44/45<br>CJ1G-CPU42H/43H/44H/45H<br>CJ1H-CPU65H/66H/67H<br>CJ1M-CPU11/12/13/21/22/23   | Features a connector for RS-232C connections (9-pin)   | CJ-series<br>CJ1G/H/M                               |
| CV500-CPU01-EV1<br>CV1000-CPU01-EV1<br>CV2000-CPU01-EV1<br>CVM1-CPU01-EV2<br>CVM1-CPU11-EV2<br>CVM1-CPU21-EV2  | Features a connector for RS-232C connections (selectable/<br>9-pin)  | CVM1/CV-series<br>CV500<br>CV1000<br>CV2000<br>CVM1 |

\* Either of the Communications Boards C200HW-COM02/COM04/COM05/COM06-EV1 is required.

## CPU Units for Connection via a 1:1 NT Link

| Model  | Specification  | PLC Type  |
|--|--|---|
| CPM1-10CDR-□<br>CPM1-20CDR-□<br>CPM1A-10CD□-□<br>CPM1A-20CD□-□<br>CPM1A-30CD□-□<br>CPM1A-40CD□-□   | RS-232C adapter connected to the peripheral port (RS-422A adapter cannot be used.) | C-series<br>CPM1                                    |
| CPM2A-30CD□□-□<br>CPM2A-40CD□□-□<br>CPM2A-60CD□□-□   | Features a 9-pin connector for RS-232C connections                                 | C-series<br>CPM2A                                   |
| CPM2C-10□□□□□□-□<br>CPM2C-20□□□□□□-□   | Connect to the RS-232C port of a CPM2C-CN111 Connecting Cable.                     | C-series<br>CPM2C                                   |
| CQM1-CPU41-EV1<br>CQM1-CPU42-EV1<br>CQM1-CPU43-EV1<br>CQM1-CPU44-EV1<br>CQM1-CPU45-EV1   | Features a 9-pin connector for RS-232C connections                                 | C-series<br>CQM1                                    |
| CQM1H-CPU21<br>CQM1H-CPU51<br>CQM1H-CPU61  | Features a 9-pin connector for RS-232C connections                                 | C-series<br>CQM1H                                   |
| C200HS-CPU21-E<br>C200HS-CPU23-E<br>C200HS-CPU31-E<br>C200HS-CPU33-E   | Features a connector for RS-232C connections (selectable/9-pin)                    | C-series<br>C200HS                                  |
| C200HE-CPU32-(Z)E <sup>(*)</sup><br>C200HE-CPU42-(Z)E  | Features a connector for RS-232C connections (selectable/9-pin)                    | C-series<br>C200HE(-Z)E                             |
| C200HG-CPU33-(Z)E <sup>(*)</sup><br>C200HG-CPU43-(Z)E<br>C200HG-CPU53-(Z)E <sup>(*)</sup><br>C200HG-CPU63-(Z)E                                       | Features a connector for RS-232C connections (selectable/9-pin)                    | C-series<br>C200HG(-Z)E                             |
| C200HX-CPU34-(Z)E <sup>(*)</sup><br>C200HX-CPU44-(Z)E<br>C200HX-CPU54-(Z)E <sup>(*)</sup><br>C200HX-CPU64-(Z)E<br>C200HX-CPU65-ZE<br>C200HX-CPU85-ZE | Features a connector for RS-232C connections (selectable/9-pin)                    | C-series<br>C200HX(-Z)E                             |
| CV500-CPU01-EV1<br>CV1000-CPU01-EV1<br>CV2000-CPU01-EV1<br>CVM1-CPU01-EV2<br>CVM1-CPU11-EV2<br>CVM1-CPU21-EV2  | Features a connector for RS-232C connections (selectable/9-pin)                    | CVM1/CV-series<br>CV500<br>CV1000<br>CV2000<br>CVM1 |

\* Either of the Communications Boards C200HW-COM02/COM04/COM05/COM06-EV1 is required.

## CPU Units for Connection via a 1:N NT Link

| Model  | Specification   | PLC Type                |
|--|---|-------------------------|
| CQM1H-CPU51 <sup>(*1)</sup><br>CQM1H-CPU61 <sup>(*1)</sup>   | Features a connector for RS-232C connections (9-pin)                | C-series<br>CQM1H       |
| C200HE-CPU32-(Z)E <sup>(*2)</sup><br>C200HE-CPU42-(Z)E   | Features a connector for RS-232C connections (selectable/<br>9-pin) | C-series<br>C200HE(-Z)E |
| C200HG-CPU33-(Z)E <sup>(*2)</sup><br>C200HG-CPU43-(Z)E<br>C200HG-CPU53-(Z)E <sup>(*2)</sup><br>C200HG-CPU63-(Z)E                                       | Features a connector for RS-232C connections (selectable/<br>9-pin) | C-series<br>C200HG(-Z)E |
| C200HX-CPU34-(Z)E <sup>(*2)</sup><br>C200HX-CPU44-(Z)E<br>C200HX-CPU54-(Z)E <sup>(*2)</sup><br>C200HX-CPU64-(Z)E<br>C200HX-CPU65-ZE<br>C200HX-CPU85-ZE | Features a connector for RS-232C connections (selectable/<br>9-pin) | C-series<br>C200HX(-Z)E |
| CS1G-CPU42/43/44/45-E(V1)<br>CS1H-CPU63/64/65/66/67-E(V1)<br>CS1G-CPU42H/43H/44H/45H<br>CS1H-CPU63H/64H/65H/66H/67H<br>CS1D-CPU65H/67H                 | Features a connector for RS-232C connections (9-pin)                | CS-series<br>CS1G/H/D   |
| CJ1G-CPU44/45<br>CJ1G-CPU42H/43H/44H/45H<br>CJ1H-CPU65H/66H/67H<br>CJ1M-CPU11/12/13/21/22/23   | Features a connector for RS-232C connections (9-pin)                | CJ-series<br>CJ1G/H/M   |

\*1: A CQM1H-SCB41 Serial Communications Board is required.

\*2: Either of the Communications Boards C200HW-COM02/COM04/COM05/COM06-EV1 is required.

## CPU Units for Connection via a High-speed NT Link (1:N)

| Model  | Specification  | PLC Type              |
|--|--|-----------------------|
| CS1G-CPU42/43/44/45-E(V1)<br>CS1H-CPU63/64/65/66/67-E(V1)<br>CS1G-CPU42H/43H/44H/45H<br>CS1H-CPU63H/64H/65H/66H/67H<br>CS1D-CPU65H/67H | Features a connector for RS-232C connections (9-pin) | CS-series<br>CS1G/H/D |
| CJ1G-CPU44/45<br>CJ1G-CPU42H/43H/44H/45H<br>CJ1H-CPU65H/66H/67H<br>CJ1M-CPU11/12/13/21/22/23   | Features a connector for RS-232C connections (9-pin) | CJ-series<br>CJ1G/H/M |

**Reference:** CS-series PLCs earlier than versions -V1 and H, and Serial Communications Boards and Units and Serial Communications Units with lot number 991220 (12/20/99) and later support the high-speed 1:N NT Link. Boards and Units with earlier lot numbers **cannot** be used.

## RS-232C/RS-422A Adapter

| Model    | Specification   |
|----------|---|
| NT-AL001 | RS-232C: 9-pin connector<br>RS-422A: 8-pin terminal block |

## RS-232C Adaptor, RS-422A Adaptor

| Model      | Specification   |
|------------|---|
| CPM1-CIF01 | Links the RS-232C port of an NT631/NT631C and the peripheral port of a CPM1, CPM2A, CPM2C, or SRM1 (compatible with host link, and NT Link (1:1)) |
| CPM1-CIF11 | Links the RS-422A port of an NT631/NT631C and the peripheral port of a CPM1, CPM2A, CPM2C, SRM1 (compatible with host link)                       |

## Related Parts and Equipment for PT

| Name          | Model         | Remark  |
|---------------|---------------|---|
| Support Tool* | NT-ZJCAT1-EV4 | Compatible with PC/AT personal computers<br>For Windows 95/98/NT4.0/2000/XP (English version)<br>CD-ROM |
| Options       | NT631C-CFL01  | Replaceable backlight (for NT631C-ST151□-EV1)   |
|               | NT631C-CFL02  | Replaceable backlight (for NT631C-ST141□-EV1)   |
|               | NT610C-KBA04  | Reflection suppressing protective sheet for NT631/NT631C  |
|               | NT625-KBA01   | Chemical-resistant cover for NT631/NT631C   |
|               | NT-MF261      | Memory Unit for NT631/NT631C  |
|               | 3G2A9-BAT08   | Spare battery   |

**Reference:** The Support Tool indicated above includes the system installer and the standard system programs (Ver. 3.□/Ver. 4.□) for the NT31, NT31C, NT631, and NT631C. System programs for the earlier NT30/620 PTs are also included.

## Cables with Connectors for PT ↔ PLC/NT-AL001

| Model     | Cable Length | Applicable Units                         | Communications Method                                 | Specification  |
|-----------|--------------|--|---|----------------|
| XW2Z-200S | 2 m          | Host Link Units with a 25-pin connector  | Serial port A host link (RS-232C only)                | 9-pin ↔ 25-pin |
| XW2Z-500S | 5 m          |  |   |                |
| XW2Z-200T | 2 m          | Host Link Units with a 9-pin connector   | Serial port A host link, NT link (1:1) (RS-232C only) | 9-pin ↔ 9-pin  |
| XW2Z-500T | 5 m          |  |   |                |
| XW2Z-S002 | 2 m          | Personal computer with a 9-pin connector | Serial port A for using NT Support Tool               | 9-pin ↔ 9-pin  |

**Note** The following PLCs can supply +5 V: C200HX/HG/HE(-Z)E, CQM1H, CPM2A, CPM2C, CS1G/H/D, and CJ1G/H/M.

## Cables with Connectors for Connecting PT and Personal Computer

| Model       | Cable Length | Specification                 |
|-------------|--------------|-------------------------------|
| CV500-CN228 | 2 m          | 25-pin (male) ↔ 9-pin (male)  |
| XW2Z-S002   | 2 m          | 9-pin (female) ↔ 9-pin (male) |

## Connection Cable

| Model                | Specification  |
|----------------------|--|
| AWG28×5P IFVV-SB     | Multicore cable, manufactured by Fujikura, Ltd.      |
| CO-MA-VV-SB 5P×28AWG | Multicore cable, manufactured by Hitachi Cable, Ltd. |

## Applicable Connectors

| Name           | Model       | Specification  |
|----------------|-------------|--|
| Connector      | XM2A-2501   | 25-pin type (male), made by OMRON                            |
|                | XM2D-2501   | 25-pin type (female), made by OMRON (for personal computers) |
|                | XM2A-0901   | 9-pin type (male), made by OMRON                             |
|                | XM2D-0901   | 9-pin type (female), made by OMRON (for personal computers)  |
|                | DB-25P      | 25-pin type (male), made by JAE                              |
| Connector hood | XM2S-2511   | 25-pin type, mm pitch screw, made by OMRON                   |
|                | XM2S-2513   | 25-pin type, inch pitch screw, made by OMRON                 |
|                | XM2S-0911   | 9-pin type, mm pitch screw, made by OMRON                    |
|                | XM2S-0911-E | 9-pin type, mm pitch screw, made by OMRON                    |
|                | XM2S-0913   | 9-pin type, inch pitch screw, made by OMRON                  |
|                | DB-C2-J9    | 25-pin type, made by JAE                                     |

## Printer Cable

| Model     | Specification                                       |
|-----------|---|
| NT-CNT121 | Printer cable for half pitch (1.5 m), made by OMRON |

## Cable for Peripheral Port of CS/CJ-series PLC

| Model      | Specification  |
|------------|--|
| CS1W-CN118 | Made by OMRON (CS-series peripheral port ↔ D-sub, 9-pin, female) |

## Connecting Cable for the CPM2C Communications Connector

| Model       | Specification  |
|-------------|--|
| CPM2C-CN111 | Made by OMRON (CPM2C communications port ↔ D-sub, 9-pin, female, C-series peripheral port) |



# Appendix K

## Option List

### Replaceable Backlights ... NT631C-CFL01 (for NT631C-ST151□-EV2)

These are backlights for NT631C for replacement purposes. Two pieces make a set.

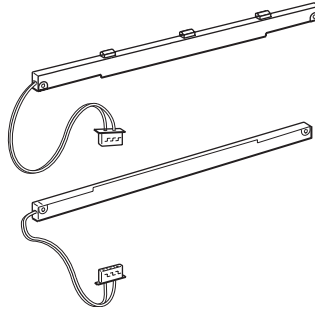

### Replaceable Backlights ... NT631C-CFL02 (for NT631C-ST141□-EV2)

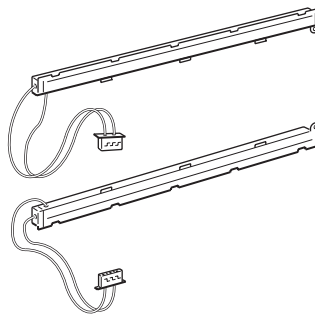

### Protective Sheet ... NT610C-KBA04

Stuck to the display to prevent irregular reflection or contamination. The entire sheet is colorless and transparent. The five sheets make a set.

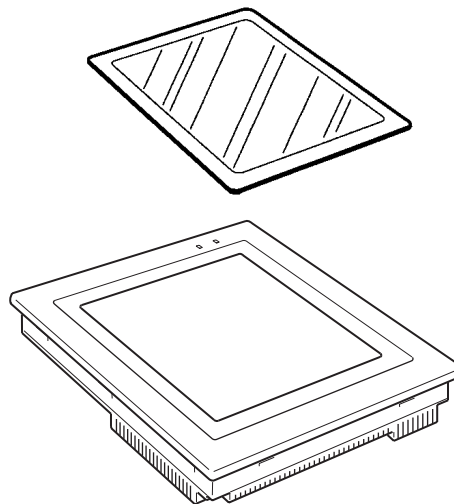

### Chemical-resistant Cover ... NT625-KBA01

Covers the front panel and protects it from various chemical agents. The entire sheet is milky white and made of silicone rubber.

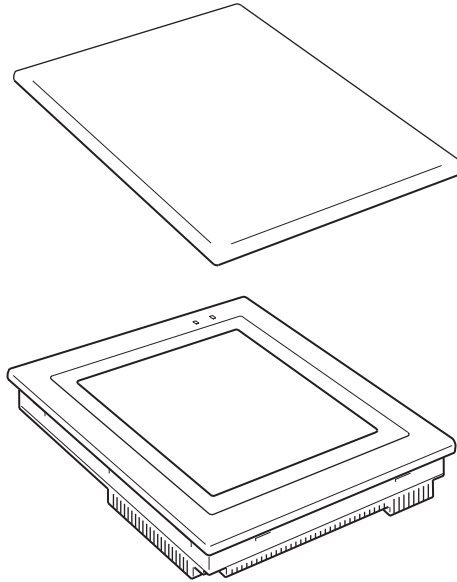

The sheet offers protection against the following chemical agents.

| Protects against        | Does not protect against |
|-------------------------|--------------------------|
| Boric acid              | Hexane                   |
| Sulfuric acid           | Lubricating oil          |
| Nitrogen                | Benzene                  |
| Ammonia gas             | Butane                   |
| Carbonic acid gas       | Carbonic acid            |
| Phenol                  | Chlorinated solvents     |
| Glycerin                | Napthalene               |
| Ammonia water           | Soy bean oil             |
| Calcium chloride        | Toluene                  |
| Developing fluid (hypo) |                          |
| Acetaldehyde            |                          |
| Lard                    |                          |

For information on chemical agents not listed in the table above, please inquire whether or not protection is offered (if the chemical agent is one against which silicone rubber is recognized as offering protection, please use this product even if the agent is not listed in the “Protects against” column of the table above).

### Replacement Battery ... 3G2A9-BAT08

This is a lithium battery used for memory backup.

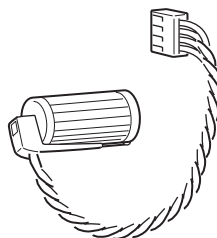

## Memory Unit ... NT-MF261

This is a dedicated unit for reading/writing the screen data and the system programs in an NT631/NT631C. Data is transmitted by DIP switch setting at the Memory Unit.

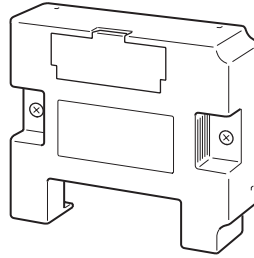



# Index

## Numerics

- 1:N connection among RS-422A ports, 119
- 1:N connection among RS-485 ports, 121
- 1:N connection between RS-422A/485 at the NT631/NT631C and RS-232C at the host, 86

## A

- Allowable power supply voltage range, 245
- Applicable connectors, 286
- Automatic transmission (memory unit), 41

## B

- Backlight (for NT631C only), 235
- Backlight brightness adjustment, 189
- Battery cover, 30
- Before operating, 23

## C

- Cable connection dimensions, 257
- Cable for peripheral port of CS1-series PLC, 286
- Cables with connectors, 285
- Calling the System Installer mode, 134
- Calling the System Menu, 133
- Cell size (Touch panel), 248
- Changing the system settings, 147
- Checking communications at serial ports, 210
- Checking communications with a printer, 213
- Checking communications with the Support Tool, 209
- Checking interfaces, 209
- Checking screen data, 198
- Checking the backlight (for NT631 only), 204
- Checking the battery voltage, 208
- Checking the buzzer, 202
- Checking the LCD (screen display), 204
- Checking the PT setting status, 193
- Checking the RUN LED, 203
- Checking touch switches, 207
- Chemical-resistant cover, 288
- Cleaning method, 242
- Clearing screen data, 135, 148
- Clearing/installing the system program, 145

- Comm. A Method, 153
- Comm. B Method, 153
- Comm. B Select, 153
- Communications Board, 62, 66, 70, 95
- Communications Boards, 106
- Communications by Using Memory Link, 21
- Communications condition, 152
- Communications condition settings for bar code readers, 184
- Communications condition settings for the host link method, 153
- Communications errors and their remedies, 233
- Communications method for communications with the host, 152
- Communications method settings, 154
- Communications methods, 26
- Communications port, 26
- Communications specifications, 250
- Communications type, 26
- Communications Unit, 281
- Comparison between NT631 and NT631C, 7
- Connecting a bar code reader, 36
- Connecting a printer, 36
- Connecting directly between RS-232C ports, 73
- Connecting to other model PLCs, 21
- Connecting to the Support Tool, 35
- Connection cable, 286
- Connection method, 26
- Contrast adjustment, 187
- CPU Unit, 95
- CPU Units, 62, 66, 70, 106, 108, 112
- CPU Units (for connection via a host link), 282
- CPU Units connectable with Host Link Units or Communications Board, 95

## D

- Device check, 201
- Device Monitor function, 220
- Dimensions, 245
- Direct connection function, 18
- Disabling/enabling System Menu display, 147
- Disabling/enabling writing to the screen data memory, 147
- Display, 29
- Display color, 247
- Display device, 247

Display specifications, 247  
Displaying and printing the display history record, 194  
Displaying/setting the calendar and clock, 191  
Downloading the system program, 146

## **E**

Effective display area, 247  
Enclosure ratings, 245  
Error messages, 229  
Errors in the system installer mode and their remedies, 232  
Errors occurring at start of operation, 229  
Errors occurring during operation, 231  
Errors occurring on screen data initialization and transmission, 232  
Errors when using a memory unit, 45  
Expansion interface connector, 30  
Expansion Mode, 132  
External interface specifications, 248, 249

## **F**

Functional ground terminal, 34

## **G**

General specifications, 245  
GR terminal, 30  
Grounding, 34, 245

## **H**

Host link, 19  
Host link method, 48, 94  
Host link unit, 48, 281

## **I**

I/O settings, 187  
In the panel, 4  
Initializing alarm history record data, 138  
Initializing display history record data, 137  
Initializing the memory switches, 143  
Initializing the memory tables, 141  
Initializing the recipe tables, 140  
Inspection method, 243

Installation environment, 32  
Installation in the operation panel, 32

## **L**

Life expectancy (backlight), 247  
Life expectancy (display panel), 247  
Life expectancy (touch panel), 248

## **M**

Maintenance Mode, 132  
Making the cable, 267  
Making the cable for connecting a PLC, 271  
Making the cable for connection to a bar code reader, 273  
Making the cable for connection to a printer, 275  
Manual transmission (memory unit), 43  
Manuals, 23  
Memory initialization, 135  
Memory link method, 73, 114  
Memory switch, 152  
Memory switch setting screen, 164  
Memory unit, 289  
Menu tree, 132  
Mounting dimensions, 256

## **N**

Noise resistance, 245  
NT link, 19  
NT link (1:1) method, 61  
NT link (1:N) method, 65, 108  
    high-speed, 70, 112  
NT-AL001, 259  
Number of dots, 247  
Number of switches (touch panel), 248

## **O**

Operating ambient humidity, 245  
Operating ambient temperature, 245  
Operating environment, 245  
Operating force, 248  
Operation at startup, 129  
Operation modes, 130

## P

Peripheral devices that can be connected, 17  
Power consumption, 245  
Power input terminals, 30  
POWER LED, 29  
Power supply connection, 33  
precautions, xv  
Precautions to be observed when transmitting screen data, 151  
Principal Functions of NT631/NT631C, 10  
Printer cable, 286  
Printer connector, 30  
Programming console function, 214  
Programming environment, 249  
Protective sheet, 287  
PT, 281

## R

Rated power supply voltage, 245  
Recipe function, 6  
Recommended printers, 36  
Relationship between system program and hardware, 277  
Relationships among modes, 130  
Replaceable backlight, 287  
Replacement battery, 288  
Replacing the backlight, 236  
Replacing the battery, 241  
Reset switch, 30  
RS-232C adaptor, 285  
RS-232C/RS-422A Adapter, 81, 285  
RS-422A adaptor, 285  
RUN, 130  
RUN LED, 29  
RUN mode, 130

## S

Screen data composition and transmission units, 150  
Screen data memory check, 205  
Selecting menu items, 134  
Serial Communications Board, 48, 66, 70, 94  
Serial Communications Unit, 48  
Serial port A, 18, 26  
Serial port A connector, 30

Serial port B, 18, 26  
Serial port B connector, 30  
Set, 155  
Setting "Screen Saver Movement", 170  
Setting the "Buzzer Sound", 166  
Setting the "Key Press Sound", 166  
Setting the "Print Method", 169  
Setting the "Printer Controller", 168  
Setting the "Start-up Wait Time", 165  
Setting the automatic reset function, 179  
Setting the bar code reader input function, 184  
Setting the communications type for serial port B, 162  
Setting the conditions for communications with the memory link method, 153  
Setting the display language in the System Installer mode, 144  
Setting the history display method, 175  
Setting the host link method, 155  
Setting the Memory Link Method, 160  
Setting the NT link (1:1) method, 157  
Setting the NT link (1:N) method, 158  
Setting the resume function, 177  
Setting the retry count, 182  
Setting the screen saver start-up time, 173  
Setting the terminal resistance, 92, 124  
Setting the time-out interval, 181  
Shock resistance (operating), 245  
Special features, 249  
Starting operation, 163  
Starting the NT31/NT31C, 129  
Storage ambient temperature, 245  
Support Tool, 285  
Switching from the System Menu to the RUN mode, 135  
Switching to the RUN mode, 163  
System configuration, 16  
System Installer Mode, 130  
System Menu, 130

## T

Terminal resistance setting terminals, 92  
Transmit Mode, 131  
Transmitting the screen data, 149  
Transporting and Storing the NT631/NT631C, 265

## **U**

Usable systems (programming console function), 215

Using a Memory Unit (NT631/NT631C with V1), 39

Using an RS-232C/RS-422A Adapter, 259

## **V**

Vibration resistance (operating), 245

View angle, 247

## **W**

Warning label, 30

waterproof, 4

Weight, 245



## Revision History

A manual revision code appears as a suffix to the catalog number on the front cover of the manual.

Cat. No. V063-E1-04

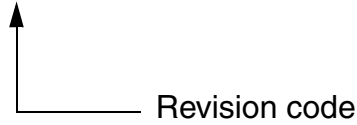

The following table outlines the changes made to the manual during each revision. Page numbers refer to the previous version.

| Revision code | Date           | Revised content  |
|---------------|----------------|--|
| 1             | July 2000      | Original production  |
| 02            | June 2004      | <p>CS1 was changed to CS, and the abbreviation for Programmable Controllers was unified to PLC.</p> <p>The following changes were also made.</p> <p><b>Page 4:</b> Added new models and details on battery replacement.</p> <p><b>Page 5:</b> Added new models to table.</p> <p><b>Page 22:</b> Corrected and added information on reference manuals to table.</p> <p><b>Page 27:</b> Added new models to table.</p> <p><b>Page 32:</b> Added information for new models to table, added note on recommended terminals, removed Note 1, and also Fig.(a) from Note 3.</p> <p><b>Page 36:</b> Added new models to introduction for 3-5.</p> <p><b>Pages 71 and 73:</b> Added information on connecting the PT.</p> <p><b>Page 76:</b> Added CS-series PLC to diagram.</p> <p><b>Page 79:</b> Added information on cables for CS-series CPU Units.</p> <p><b>Page 85:</b> Changed information on shielding, and corrected diagram.</p> <p><b>Page 86:</b> Removed information on cables with connectors.</p> <p><b>Page 87:</b> Removed information on cables with connectors, and added information on cables for CS-series CPU Units.</p> <p><b>Pages 89, 90, and 91:</b> Changed information on shielding, and corrected diagrams.</p> <p><b>Pages 92 and 93:</b> Removed information on cables with connectors.</p> <p><b>Pages 113, 114, 115, 116, 117, 118, 119, and 120:</b> Changed information on shielding, and corrected diagrams.</p> <p><b>Page 122:</b> Added sub-section on shielding.</p> <p><b>Page 140:</b> Added information on System Installer mode versions.</p> <p><b>Page 174:</b> Corrected "0" to "1" in the time-out interval setting range.</p> <p><b>Page 175:</b> Removed 00 from the setting sequence in the diagram.</p> <p><b>Page 183:</b> Added new model numbers.</p> <p><b>Page 213:</b> Added information on CS1G/CS1H connections and changed "can" to "cannot" in final paragraph.</p> <p><b>Pages 214 and 219:</b> Changed "can" to "cannot" in *1, and changed note on error screen.</p> <p><b>Page 218:</b> Changed note on error screen.</p> <p><b>Page 229:</b> Added information to touch switch operation.</p> <p><b>Page 232:</b> Added information on backlight replacement for new models.</p> <p><b>Page 235:</b> Changed "NT631C" to "PT" in step 1.</p> <p><b>Page 239:</b> Changed and added information in table on power supply voltage and backlight brightness.</p> <p><b>Page 241:</b> Changed specifications tables to add information on new models, and added diagram.</p> <p><b>Page 242:</b> Changed specifications tables to add information on new models.</p> <p><b>Page 243:</b> Added model number.</p> <p><b>Page 255:</b> Changed "JIS C0911" to "JIS C0040" and "JIS C0912" to "JIS C0041" in table.</p> <p><b>Page 263:</b> Changed diagrams and added note.</p> <p><b>Pages 269, 270, 271, and 273:</b> Added model numbers.</p> |
| 03            | September 2007 | New models added, descriptions added, and errors corrected.  |
| 04            | October 2011   | Made changes accompanying changes in backlight specifications.   |

---

*Revision History*

---



**OMRON Corporation** Industrial Automation Company  
Tokyo, JAPAN

Contact: [www.ia.omron.com](http://www.ia.omron.com)

**Regional Headquarters**

**OMRON EUROPE B.V.**

Wegalaan 67-69-2132 JD Hoofddorp  
The Netherlands

Tel: (31)2356-81-300/Fax: (31)2356-81-388

**OMRON ELECTRONICS LLC**

One Commerce Drive Schaumburg,  
IL 60173-5302 U.S.A.

Tel: (1) 847-843-7900/Fax: (1) 847-843-7787

**OMRON ASIA PACIFIC PTE. LTD.**

No. 438A Alexandra Road # 05-05/08 (Lobby 2),  
Alexandra Technopark,  
Singapore 119967

Tel: (65) 6835-3011/Fax: (65) 6835-2711

**OMRON (CHINA) CO., LTD.**

Room 2211, Bank of China Tower,  
200 Yin Cheng Zhong Road,  
PuDong New Area, Shanghai, 200120, China

Tel: (86) 21-5037-2222/Fax: (86) 21-5037-2200

**Authorized Distributor:**

© OMRON Corporation 2011 All Rights Reserved.  
In the interest of product improvement,  
specifications are subject to change without notice.

Printed in Japan

**Cat. No. V063-E1-04**

1011