

Materials Required for Installation

- Tape Measure
- Square Ruler
- Scrap piece of LVT/P material tapping to tighten joints
- Utility Knife
- Chalk Line
- Small Hand Roller (Seam Roller)



Acceptable Underlayments

• Wood Underlayment

Can go over virtually any sound wood underlayments/subfloors. Always fasten underlayment in accordance with the manufacturer's recommendations. Any failure of the underlayment or flooring as a result of the underlayment is NOT the responsibility of Hanflor.

• Concrete Subfloors

Moisture levels of concrete slabs before, during and after installation must be 8 lbs. or less per 1000 square feet per 24 hours using an anhydrous calcium chloride test according to ASTM F1869 and pH must be between 5.0 and 9.0; or, if using ASTM F2170 IN-Situ Probes, should be less than 80% RH (relative humidity).

• Ceramic tile ground

• Marble, terrazzo or other solid and level ground

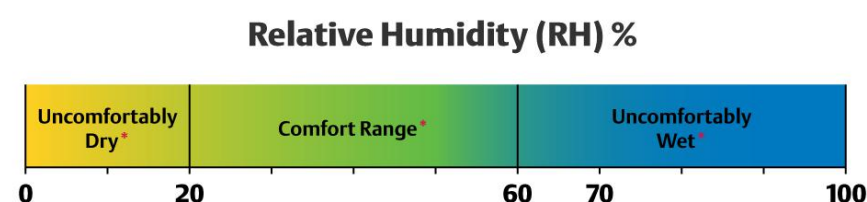

*For 80% or more of the occupants in a space



Wood Underlayment

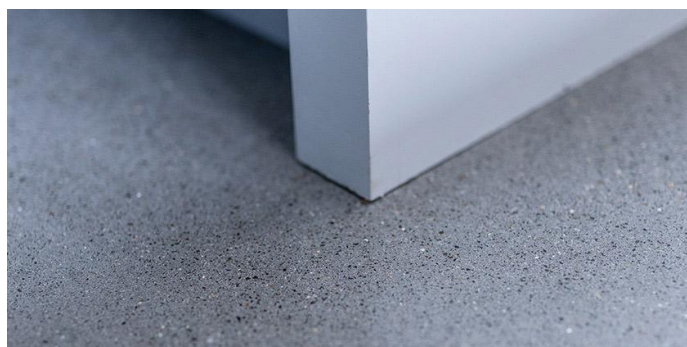

Concrete Subfloors



Ceramic tile ground



Marble Ground



Terrazzo Ground



Self-leveling Ground

Pre-Installation

1. Check carefully whether there are any defects in the floor material. If any defects are found, please contact your supplier immediately.
2. The floor should be transported and stored neatly stacked on a smooth and flat surface.
3. Before installation, during installation, and within 48 hours after installation, adapt to the floor and room to be installed at a constant temperature of 65°F to 85°F (18.33°C and 29.44°C).
4. The work site has been cleaned up, and there is no debris that may damage the installation of the finished wood board.
5. Leave an expansion space of 8~10mm around the entire perimeter of the floor.
6. Keep away from any heating/cooling pipes or direct sunlight.

↓↓↓

Temperature - Trogir, Croatia

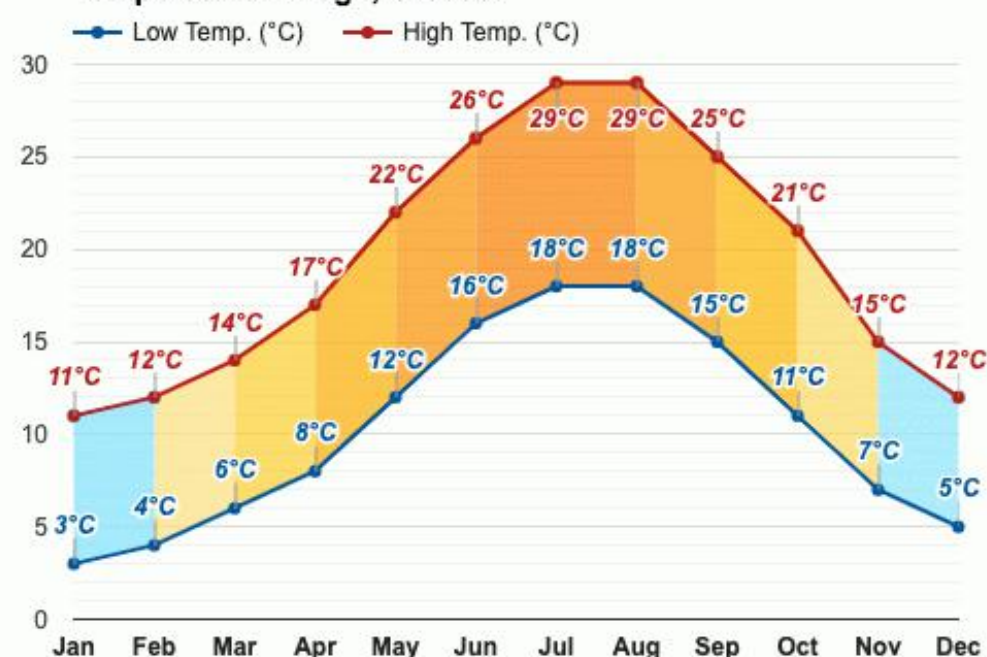

Installation

Hanflor is engineered to be installed utilizing the floating method. Do not install cabinets or fixed objects on top of Hanflor. Proper expansion space is required. Undercut all doorjamb. Do not fasten wall moldings and or transition strips to the floor and planks.

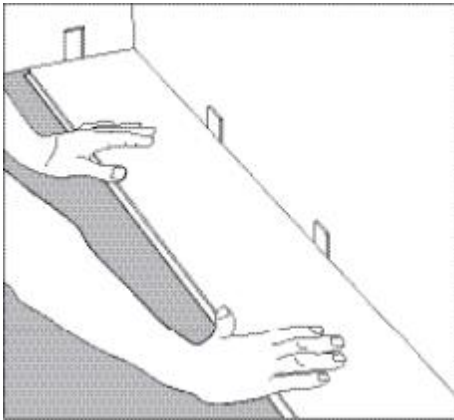

Step 1: Begin installation working from left to right. Insert spacers at ends and edges where planks meet wall.

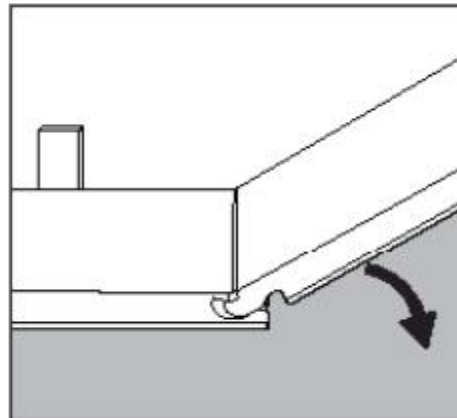

Step 2: Lock short end of plank by inserting tongue into groove at an angle and drop in place. Continue to end of first row.

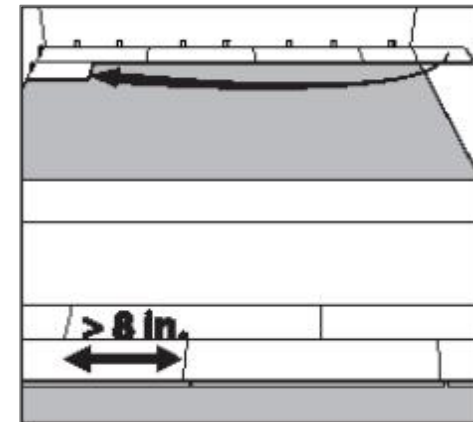

Step 3: Use leftover plank from first row as starter for second row. There must be at least 8" between plank end joints on adjacent rows.

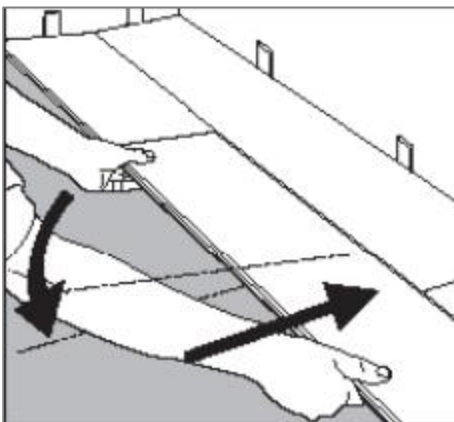

Step 4: Lock long edge of plank by inserting tongue into groove at an angle and drop in place. Slide plank toward end of previously installed plank until the tongue just touches the groove.

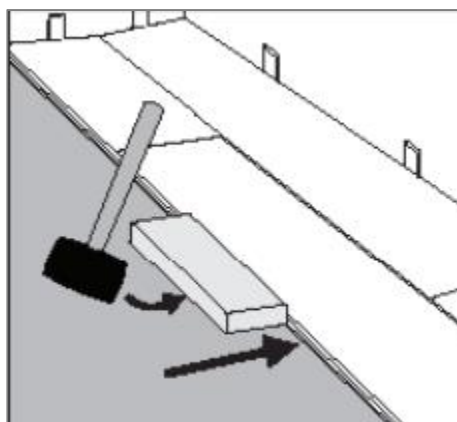

Step 5: Important! Use hammer and tapping block to tap long edge of plank to ensure a tight fit. Any gapping can compromise the locking system.

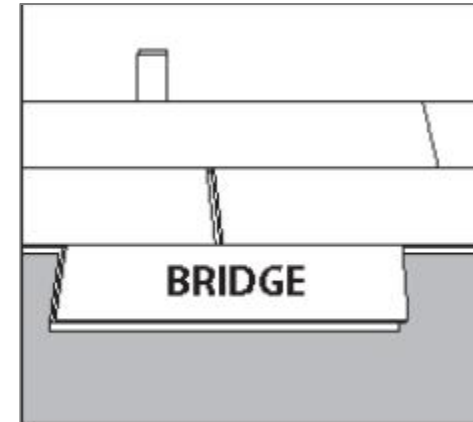

Step 6: Attach a scrap piece of floor to bridge gap between ends of planks.

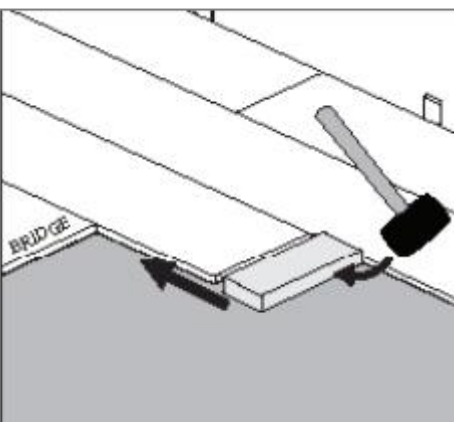

Step 7: Tap end of plank with hammer and tapping block to lock ends of planks together. Remove bridge and continue towards wall until installing the final plank in the row. Be sure to tap on edge of vinyl so as not to damage locking profile.

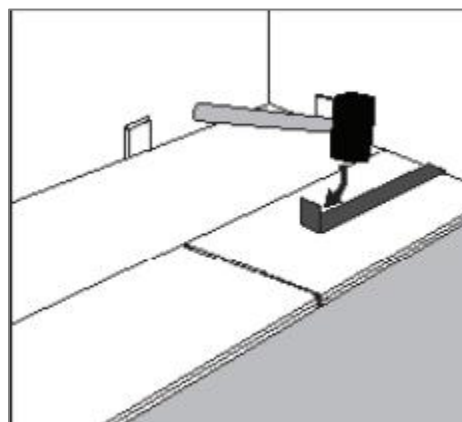

Step 8: Use hammer and pull bar to lock final piece in row. Insert spacer at end of row. Continue installation to final row.

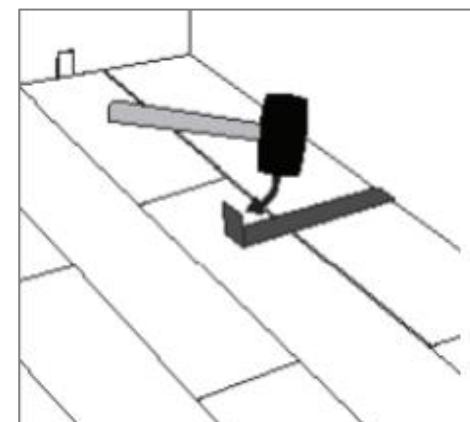

Step 9: Use hammer and pull bar to lock long edges of planks on final row.

Installing under door jambs

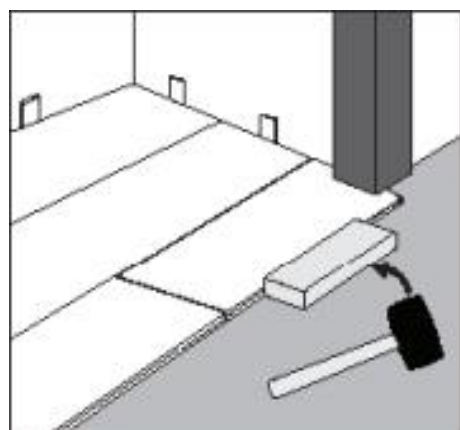

Step 1: Undercut space under door jamb to allow plank to slide freely. Tap long edge with hammer and tapping block to lock long edge.

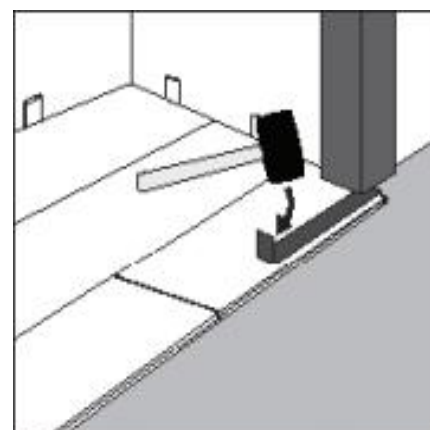

Step 2: Use hammer and pull bar to lock short end of plank.

Precautions

1. Hanflor' s LVT Click products can be installed directly over most existing floor coverings, except for carpet, laminate, floating floors systems and cushioned vinyl flooring.
2. The ground temperature is in the range of 65°F to 85°F (18.33°C and 29.44°C)
3. Within 24 hours, keep foot traffic away from the replaced planks/tiles
4. Leaving seam picture: 8-10mm cut the last board of the first row, leaving an expansion gap of at least 5/16"-8mm.
5. Vinyl tiles are resistant to water damage, but cannot prevent the spread of moisture. Cannot be used in shower room
6. Cannot be used for balcony or sun room
7. Cannot install doors or cabinets and other furniture directly on the floor
8. Do not wash the floor with water. After scrubbing the floor, wipe off the water in time to prevent water stains from entering the gaps.
9. Do not be too tight or too loose when installing. When the entire installation area is larger than 8 meters, it needs to be separated by T-moulding.

Maintenance:

- When moving electrical appliances or heavy furniture, lay a layer of plywood on the floor and "walk" objects on the panel. Do not slide appliances or furniture on the floor.
- Avoid prolonged exposure to direct sunlight, as this will cause discoloration and swelling. Need to use curtains, sunshade systems or protective window film.
- Do not expose the floor to temperatures exceeding 140°F.
- Oil or petroleum-based products may cause surface staining. Don't let asphalt or car oil drip onto the vinyl floor.
- Wheelchairs with casters should have wide rubber casters. The underside of the office chair needs a protective pad

- Use non-stained pads. Rubber may discolor the floor.
- Furniture that moves frequently should be equipped with felt pads to avoid scratching the floor. Heavy furniture and electrical appliances should be equipped with large-scale non-polluting ground protection devices.
- Use removable mats at the entrance to prevent dust and grit from being dragged to the floor.
- Clean regularly. Do not use a vacuum cleaner that uses a beating rod or turning off the beating rod.
- Do not use an electric broom with a hard plastic bottom without a liner.
- Wet the mop with clean water and diluted floor cleaner as needed. Do not use harsh cleaners or chemicals on the floor.
- After cleaning, dry the water. Take care to prevent moisture from accumulating on both sides of the vinyl floor to prevent unhealthy mold growth.