

MB23-0501

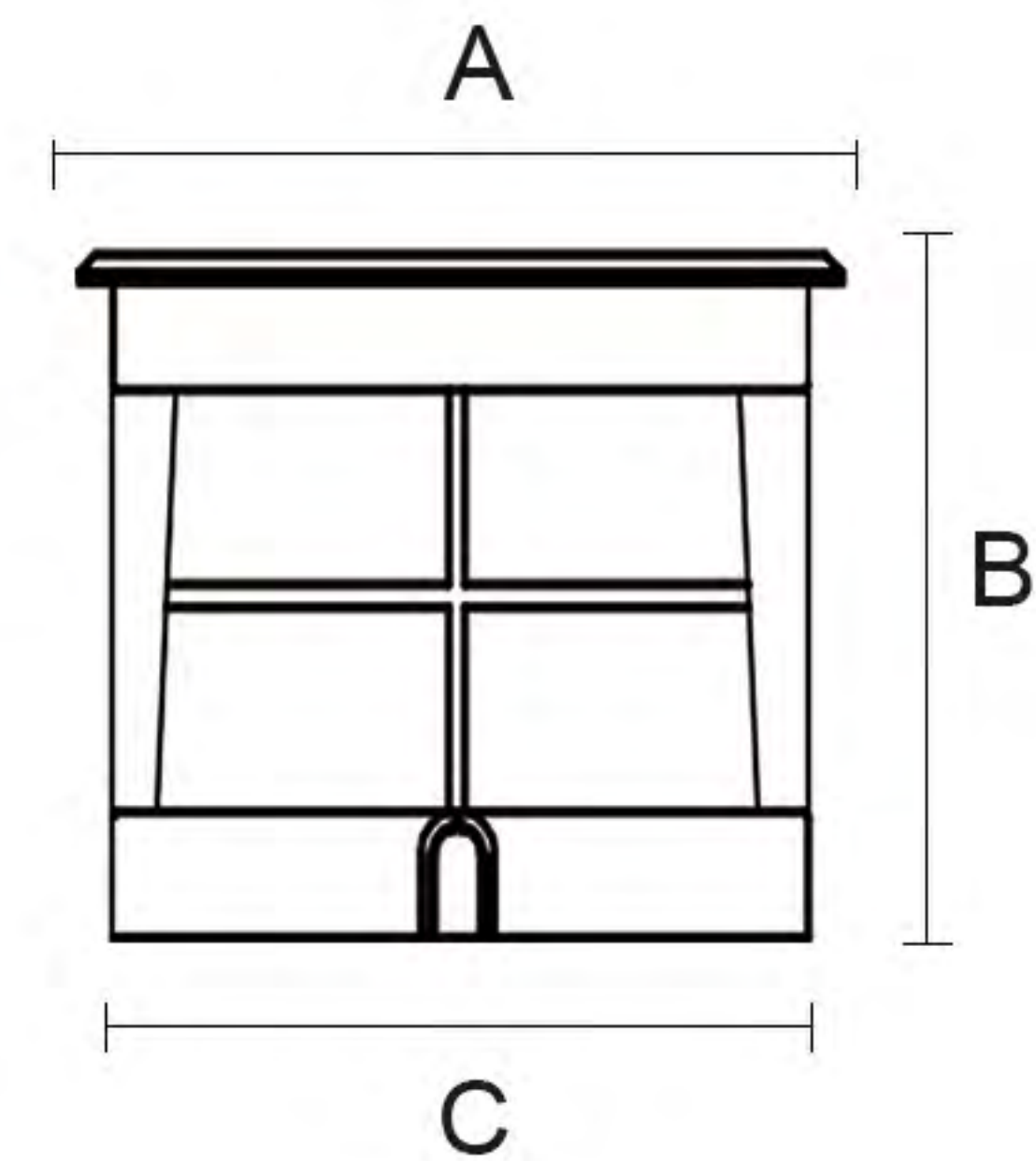

Features&Benefit (功能和优点)

Category (品类)	Underground Light
Diffuser Material (扩散器材质)	Glass
Cover Material (面盖材质)	Aluminum+Stainless steel
Operating mode (运行)	Built in
Steuerbar (开关)	On/Off
IP (防水等级)	67
Mounting type (安装类型)	Put
Mounting location (安装位置)	Underground
Application environment (应用环境)	Indoor/Outdoor
Cut out (预埋件)	Ø95*75mm/Ø115*89mm/145*89mm Ø155*89mm/Ø185*89mm/Ø235*89mm/Ø293*89mm

Product Description (产品描述)

Suitable for squares, outdoor parks, leisure places, parks, green lawns, courtyards, flower beds, pedestrian street decoration, waterfalls, fountains and other outdoor night lighting, adding luster to the environment.

Lightmap (光影图)

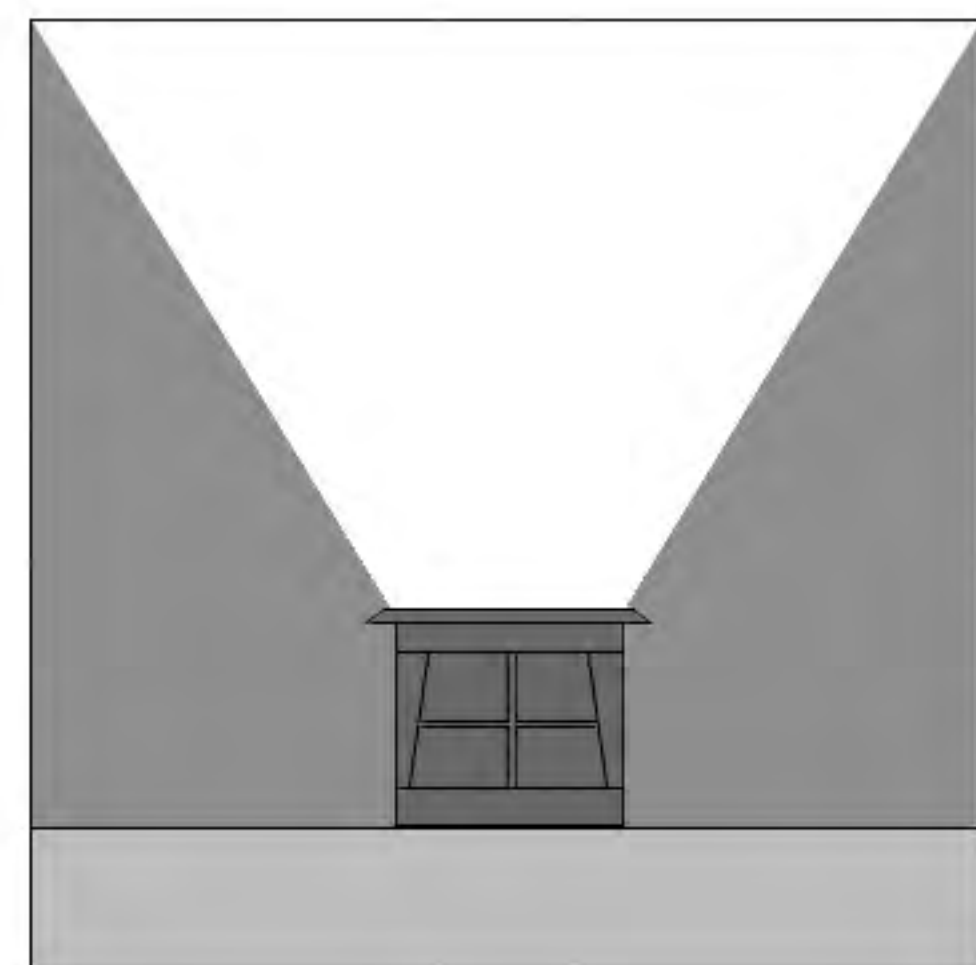

front view (正面图)



Technical Date (技术参数)

Item No.	Lamp Type	Power	LM	CCT	PF	Voltage	CRI	A	B	C (mm)
MB23-0501100	LED	6W	420	2700K-6000K	0.6	AC110-265V	80-90	Ø100	78	Ø95
MB23-0501120	LED	12W	840	2700K-6000K	0.6	AC110-265V	80-90	Ø120	92	Ø115
MB23-0501160	LED	18W	1260	2700K-6000K	0.6	AC110-265V	80-90	Ø160	92	Ø145
MB23-0501180	LED	24W	1680	2700K-6000K	0.9	AC110-265V	80-90	Ø180	92	Ø155
MB23-0501200	LED	36W	2520	2700K-6000K	0.9	AC110-265V	80-90	Ø200	92	Ø185
MB23-0501250	LED	48W	3360	2700K-6000K	0.9	AC110-265V	80-90	Ø250	92	Ø235
MB23-0501320	LED	72W	5040	2700K-6000K	0.9	AC110-265V	80-90	Ø320	92	Ø293

MB23-0502

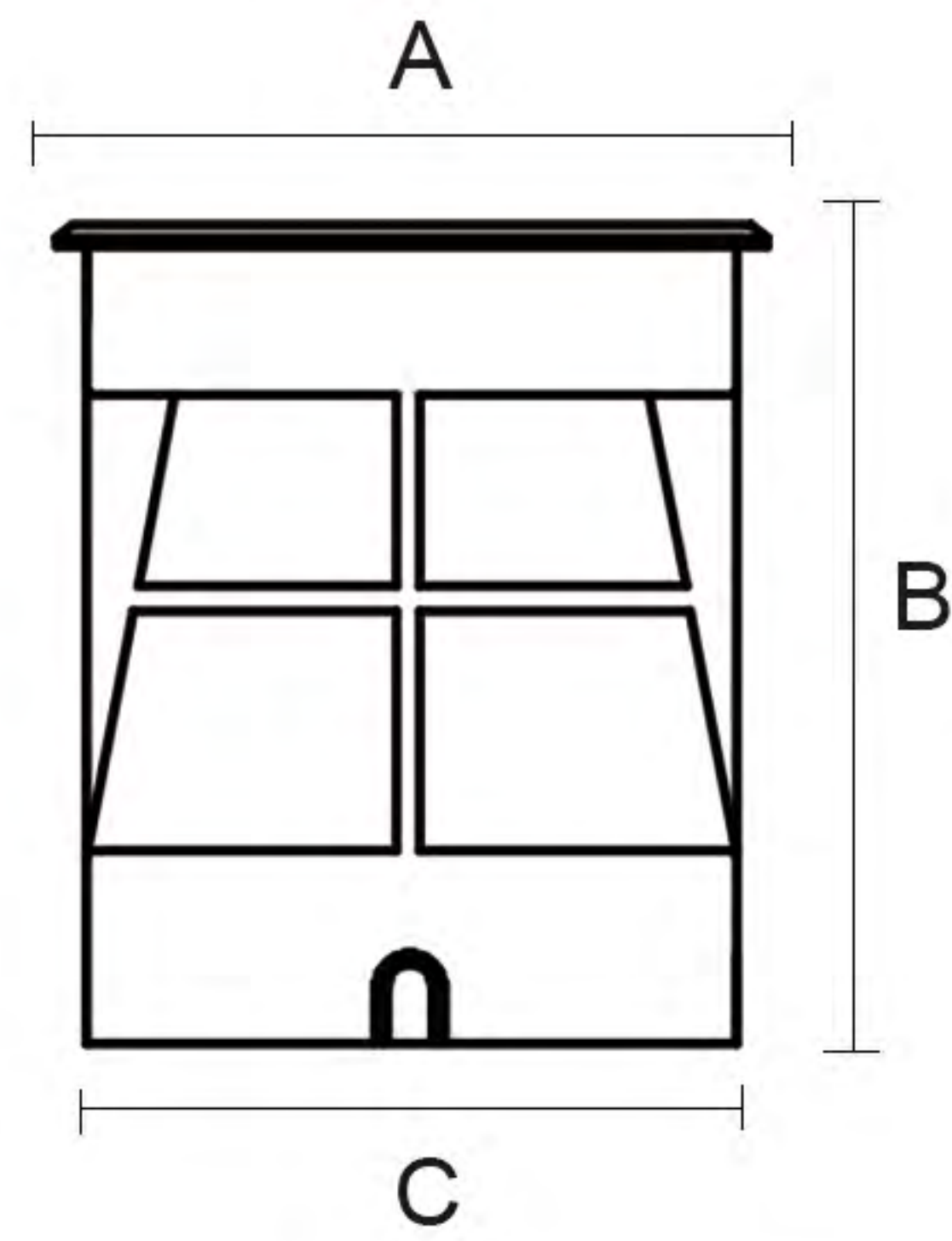

Features&Benefit (功能和优点)

Category (品类)	Underground Light
Diffuser Material (扩散器材质)	Glass
Cover Material (面盖材质)	Aluminum+Stainless steel
Operating mode (运行)	Built in
Steuerbar (开关)	On/Off
IP (防水等级)	67
Mounting type (安装类型)	Put
Mounting location (安装位置)	Underground
Application environment (应用环境)	Indoor/Outdoor
Cut out (预埋件)	Ø115*135mm/Ø144*150mm 170*163mm/Ø242*190mm

Product Description (产品描述)

Suitable for squares, outdoor parks, leisure places, parks, green lawns, courtyards, flower beds, pedestrian street decoration, waterfalls, fountains and other outdoor night lighting, adding luster to the environment.

Lightmap (光影图)

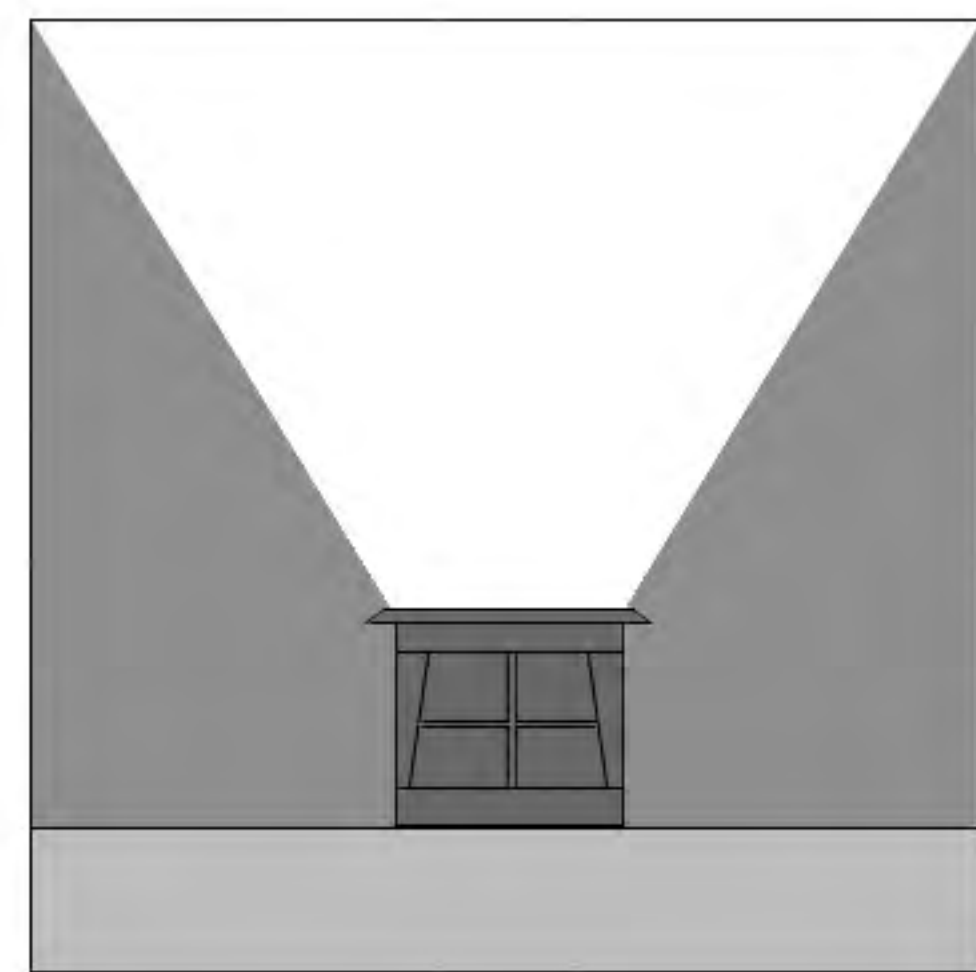

front view (正面图)



Technical Date (技术参数)

Item No.	Lamp Type	Power	LM	CCT	PF	Voltage	CRI	A	B	C (mm)
MB23-0502130	LED	6W	420	2700K-6000K	0.6	AC110-265V	80-90	Ø130	140	Ø115
MB23-0502160	LED	18W	1260	2700K-6000K	0.6	AC110-265V	80-90	Ø160	153	Ø144
MB23-0502200	LED	24W	1680	2700K-6000K	0.9	AC110-265V	80-90	Ø200	163	Ø170
MB23-0502250	LED	36W	2520	2700K-6000K	0.9	AC110-265V	80-90	Ø250	193	Ø242

MB23-0503

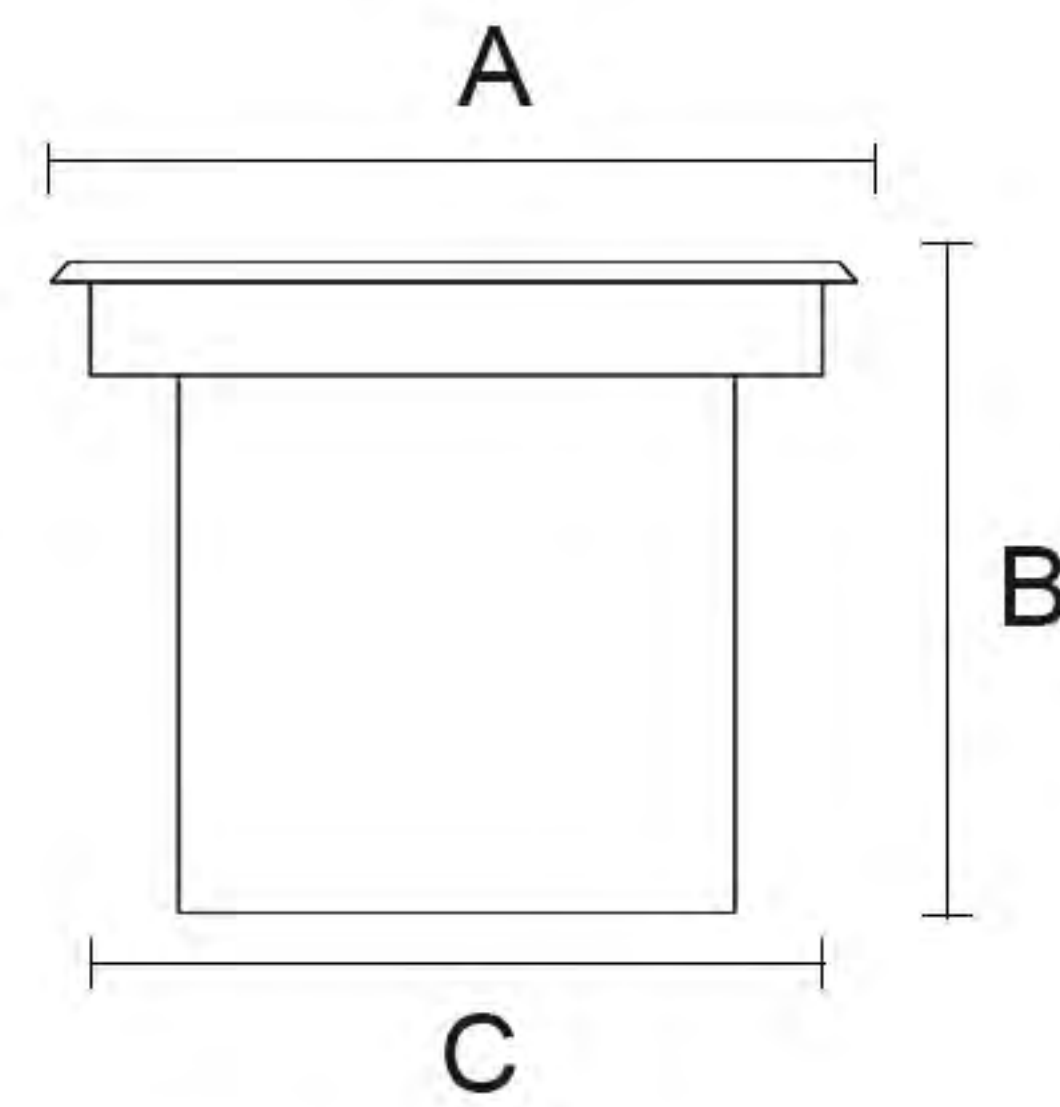

Features&Benefit (功能和优点)

Category (品类)	Underground Light
Diffuser Material (扩散器材质)	Glass
Cover Material (面盖材质)	Aluminum+Stainless steel
Operating mode (运行)	Built in
Steuerbar (开关)	On/Off
IP (防水等级)	65
Mounting type (安装类型)	Put
Mounting location (安装位置)	Underground
Application environment (应用环境)	Indoor/Outdoor
Cut out (预埋件)	Ø60*70mm/Ø75*70mm/Ø95*80mm Ø115*90mm/Ø125*90mm/Ø155*90mm Ø165*90mm/Ø185*90mm/Ø240*90mm/Ø290*90mm

Product Description (产品描述)

Suitable for squares, outdoor parks, leisure places, parks, green lawns, courtyards, flower beds, pedestrian street decoration, waterfalls, fountains and other outdoor night lighting, adding luster to the environment.

Lightmap (光影图)

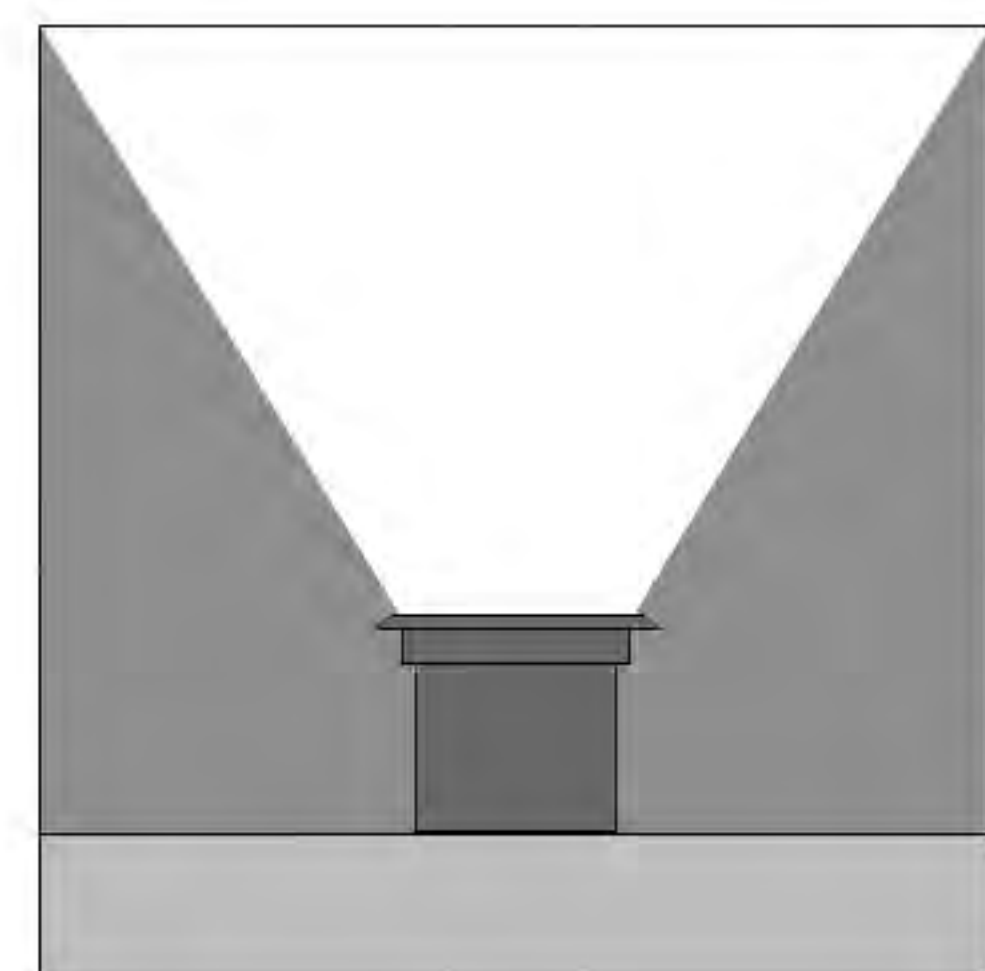

front view (正面图)

Technical Date (技术参数)

Item No.	Lamp Type	Power	LM	CCT	PF	Voltage	CRI	A	B	C (mm)
MB23-050365	LED	1W	70	2700K-6000K	0.6	AC110-265V	80-90	Ø65	75	Ø60
MB23-050380	LED	3W	210	2700K-6000K	0.6	AC110-265V	80-90	Ø80	75	Ø75
MB23-0503100	LED	5W	350	2700K-6000K	0.6	AC110-265V	80-90	Ø100	85	Ø95
MB23-0503120	LED	6W	420	2700K-6000K	0.6	AC110-265V	80-90	Ø120	95	Ø115
MB23-0503150	LED	9W	630	2700K-6000K	0.6	AC110-265V	80-90	Ø150	95	Ø125
MB23-0503160	LED	12W	840	2700K-6000K	0.6	AC110-265V	80-90	Ø160	95	Ø155
MB23-0503180	LED	15W	1050	2700K-6000K	0.6	AC110-265V	80-90	Ø180	95	Ø165
MB23-0503200	LED	18W	1260	2700K-6000K	0.6	AC110-265V	80-90	Ø200	95	Ø185
MB23-0503250	LED	24W	1680	2700K-6000K	0.9	AC110-265V	80-90	Ø250	95	Ø240
MB23-0503300	LED	36W	2520	2700K-6000K	0.9	AC110-265V	80-90	Ø300	95	Ø290

MB23-0504

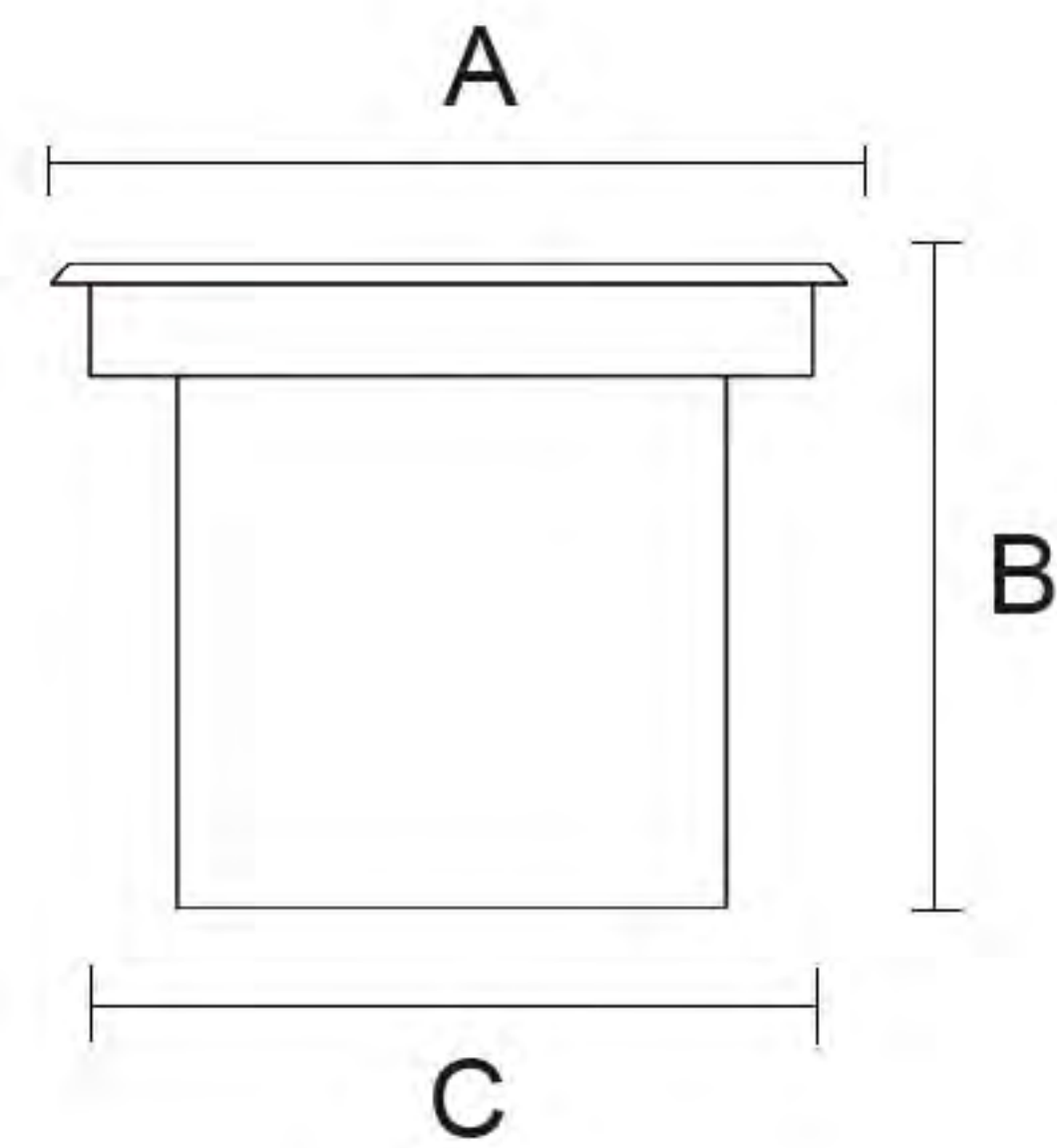

Features&Benefit (功能和优点)

Category (品类)	Underground Light
Diffuser Material (扩散器材质)	Glass
Cover Material (面盖材质)	Aluminum+Stainless steel
Operating mode (运行)	Built in
Steuerbar (开关)	On/Off
IP (防水等级)	65
Mounting type (安装类型)	Put
Mounting location (安装位置)	Underground
Application environment (应用环境)	Indoor/Outdoor
Cut out (预埋件)	Ø60*70mm/Ø75*70mm/Ø95*80mm Ø115*90mm/Ø155*90mm/Ø165*90mm Ø185*90mm/Ø206*90mm/Ø240*90mm

Product Description (产品描述)

Suitable for squares, outdoor parks, leisure places, parks, green lawns, courtyards, flower beds, pedestrian street decoration, waterfalls, fountains and other outdoor night lighting, adding luster to the environment.

Lightmap (光影图)

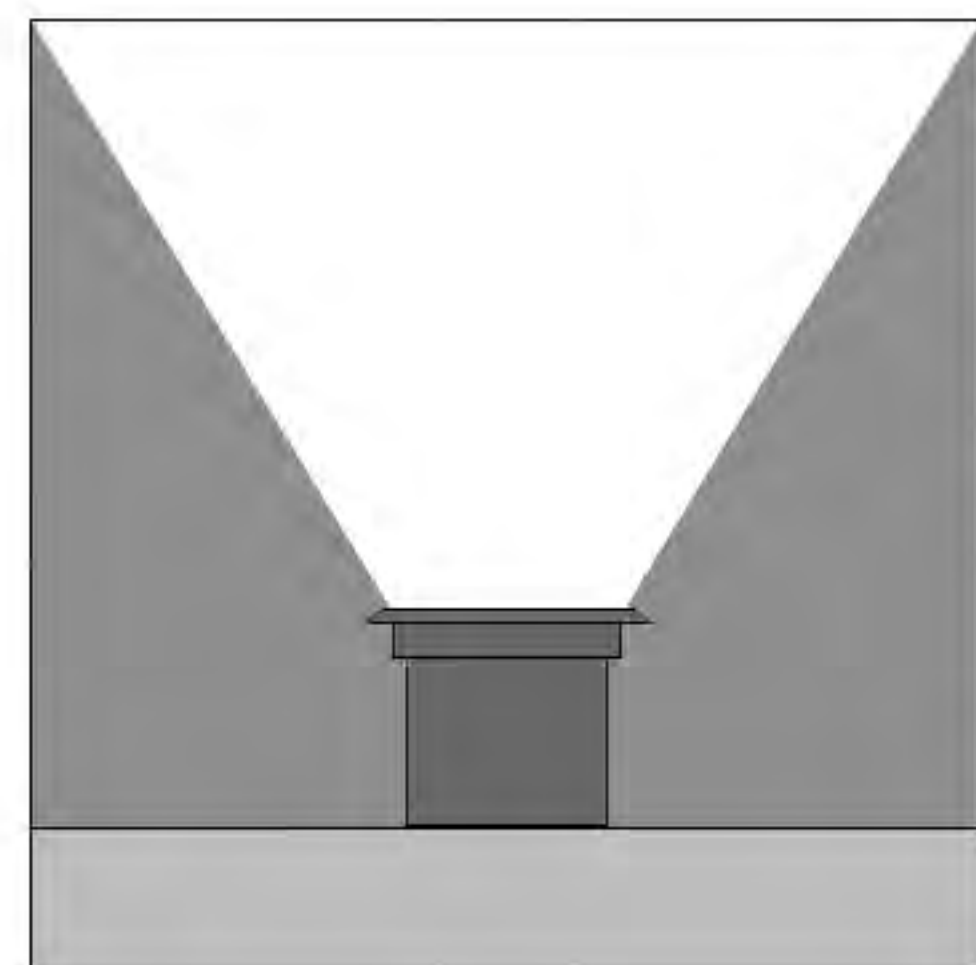

front view (正面图)

Technical Date (技术参数)

Item No.	Lamp Type	Power	LM	CCT	PF	Voltage	CRI	A	B	C (mm)
MB23-050465	LED	3W	210	2700K-6000K	0.6	AC110-265V	80-90	Ø65	75	Ø60
MB23-050480	LED	5W	350	2700K-6000K	0.6	AC110-265V	80-90	Ø80	75	Ø75
MB23-0504100	LED	7W	490	2700K-6000K	0.6	AC110-265V	80-90	Ø100	85	Ø95
MB23-0504120	LED	10W	700	2700K-6000K	0.6	AC110-265V	80-90	Ø120	95	Ø115
MB23-0504160	LED	15W	1050	2700K-6000K	0.6	AC110-265V	80-90	Ø160	95	Ø155
MB23-0504180	LED	20W	1400	2700K-6000K	0.9	AC110-265V	80-90	Ø180	95	Ø165
MB23-0504200	LED	30W	2100	2700K-6000K	0.9	AC110-265V	80-90	Ø200	95	Ø185
MB23-0504220	LED	40W	2800	2700K-6000K	0.9	AC110-265V	80-90	Ø220	95	Ø206
MB23-0504250	LED	50W	3500	2700K-6000K	0.9	AC110-265V	80-90	Ø250	95	Ø240

MB23-0505

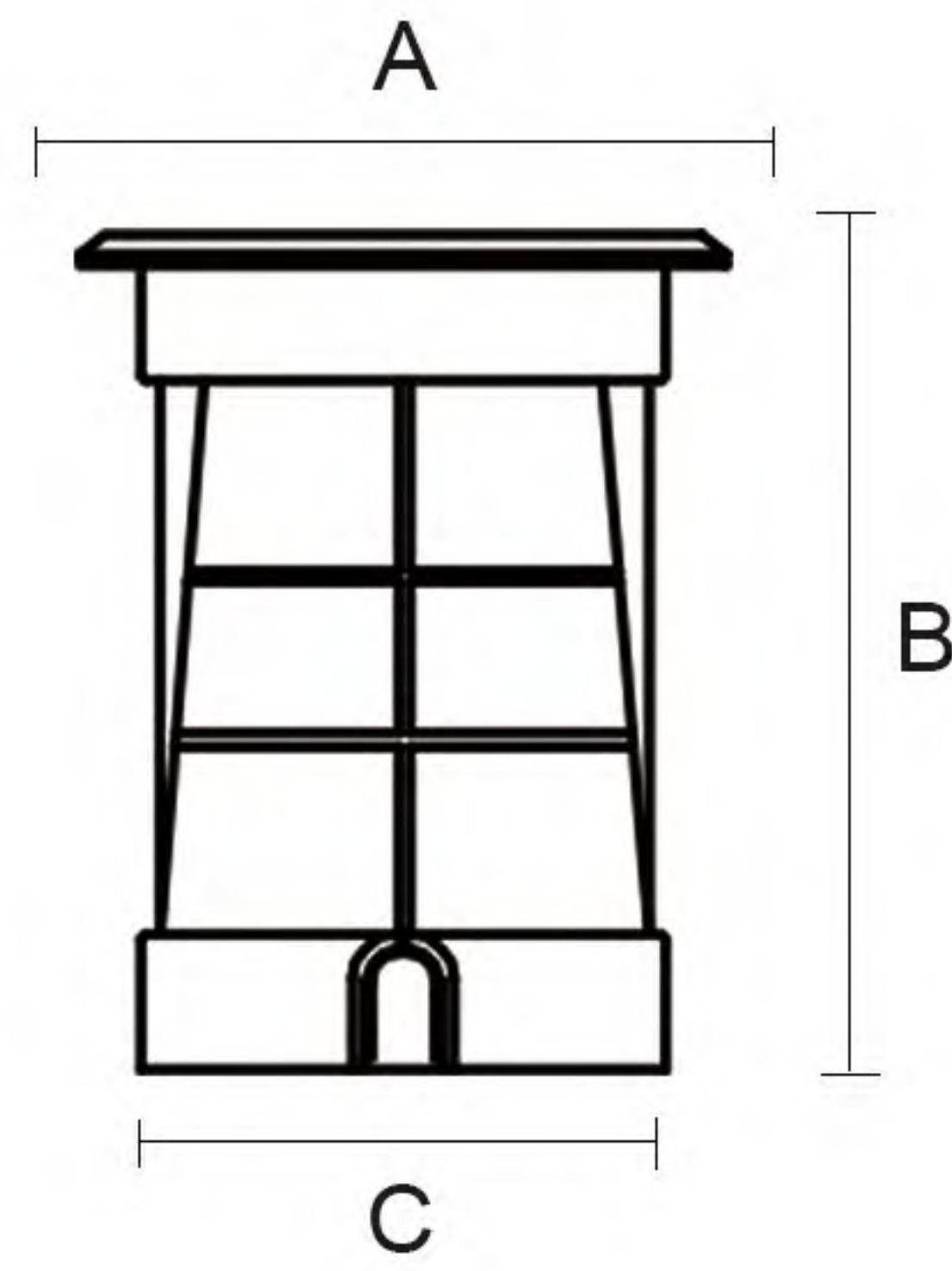

Features&Benefit (功能和优点)

Category (品类)	Underground Light
Diffuser Material (扩散器材质)	Glass
Cover Material (面盖材质)	Aluminum+Stainless steel
Operating mode (运行)	Built in
Steuerbar (开关)	On/Off
IP (防水等级)	65
Mounting type (安装类型)	Put
Mounting location (安装位置)	Underground
Application environment (应用环境)	Indoor/Outdoor
Cut out (预埋件)	Ø65*92mm

Product Description (产品描述)

Suitable for squares, outdoor parks, leisure places, parks, green lawns, courtyards, flower beds, pedestrian street decoration, waterfalls, fountains and other outdoor night lighting, adding luster to the environment.

Lightmap (光影图)

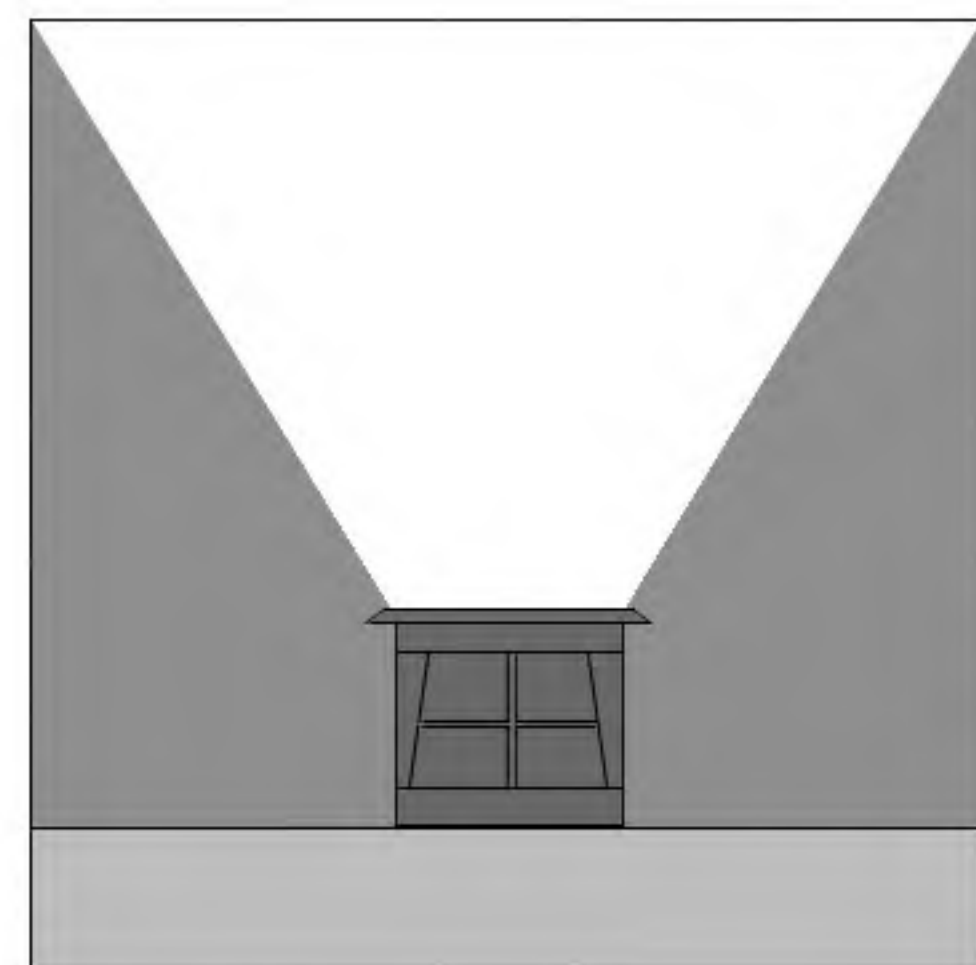

front view (正面图)

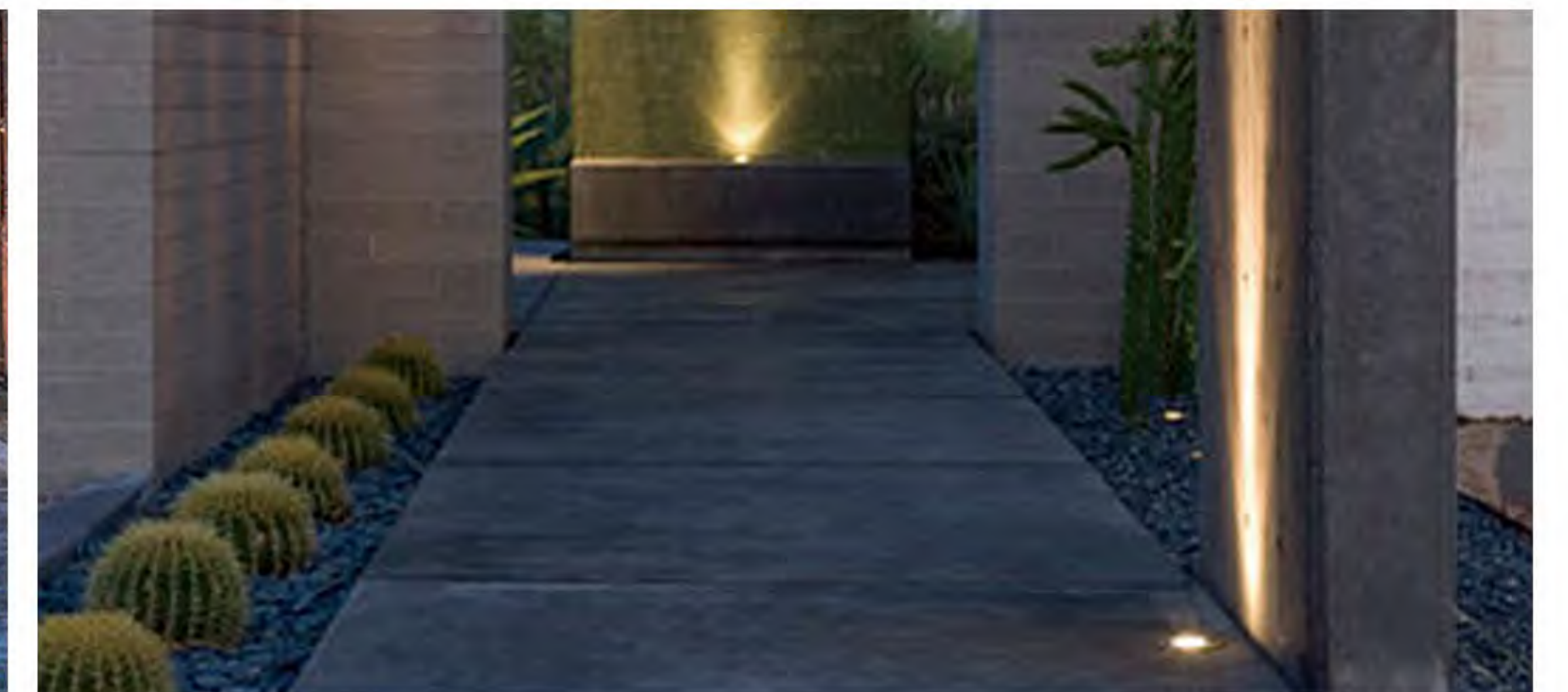
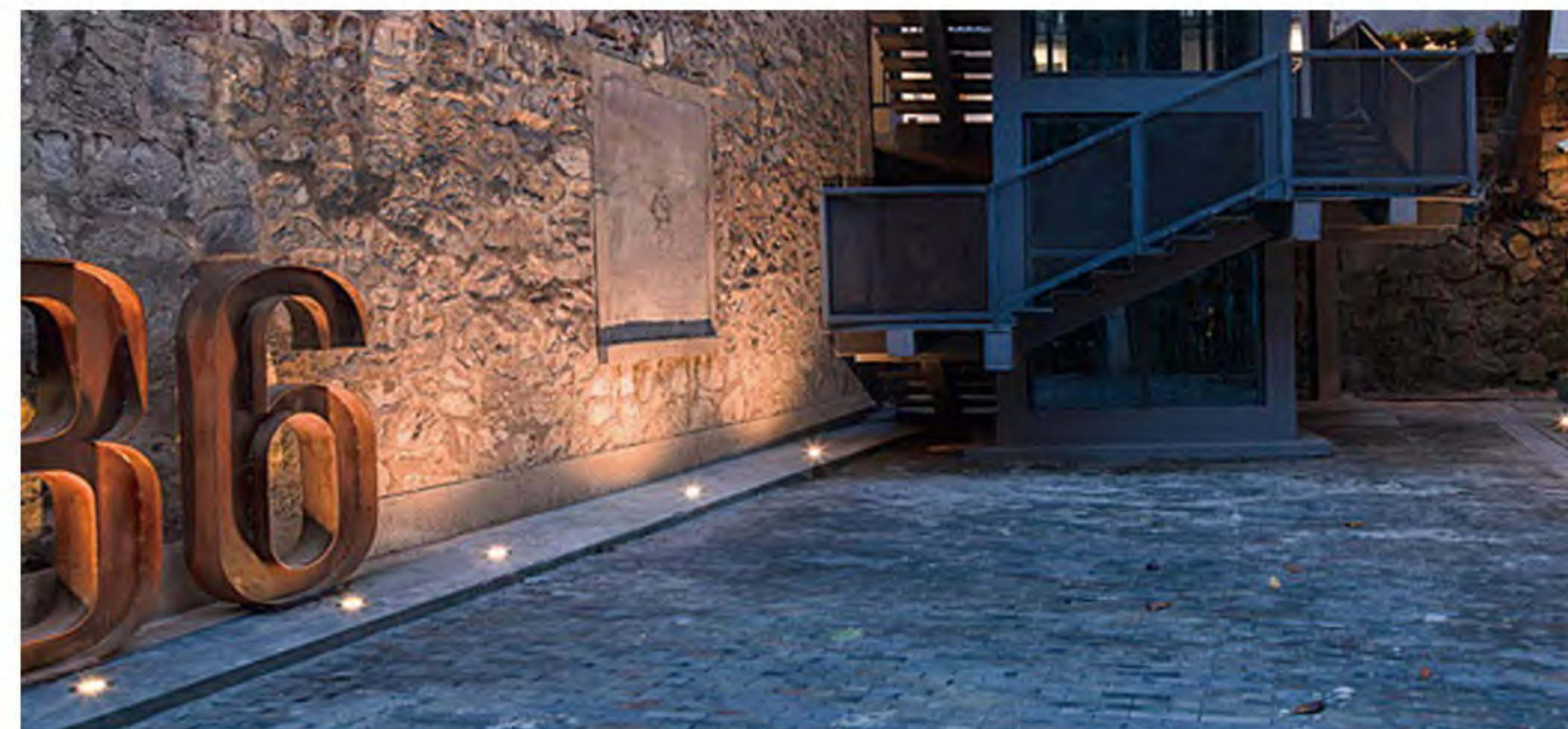

Technical Date (技术参数)

Item No.	Lamp Type	Power	LM	CCT	PF	Voltage	CRI	A	B	C (mm)
MB23-0505	LED	5W	350	2700K-6000K	0.6	AC110-265V	80-90	Ø80	95	Ø65

MB23-0506



Features&Benefit (功能和优点)

Category (品类)	Underground Light
Diffuser Material (扩散器材质)	Glass
Cover Material (面盖材质)	Stainless steel
Operating mode (运行)	Built in
Steuerbar (开关)	On/Off
IP (防水等级)	65
Mounting type (安装类型)	Put
Mounting location (安装位置)	Underground
Application environment (应用环境)	Indoor/Outdoor
Cut out (预埋件)	Ø17*34mm/Ø17*36mm/Ø16.5*55mm Ø13*30mm/Ø12*27mm/Ø11*35mm

Product Description (产品描述)

Suitable for squares, outdoor parks, leisure places, parks, green lawns, courtyards, flower beds, pedestrian street decoration, waterfalls, fountains and other outdoor night lighting, adding luster to the environment.

Lightmap (光影图)

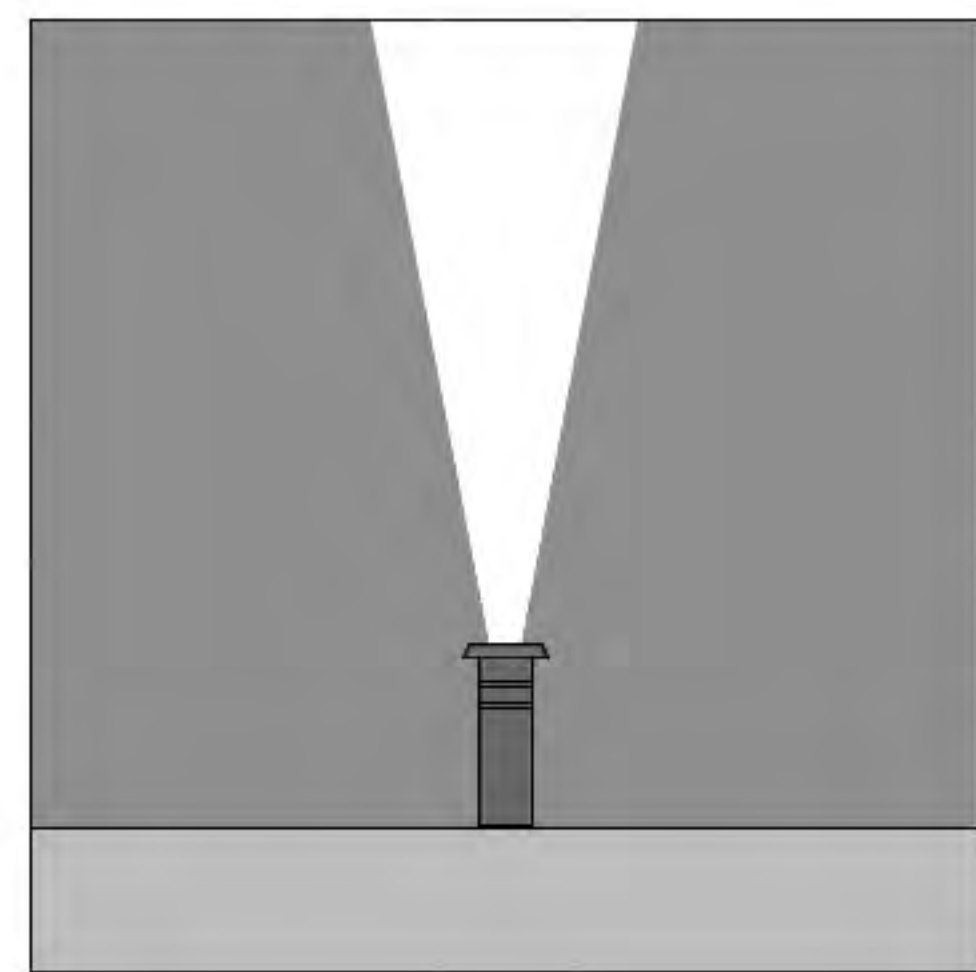

front view (正面图)

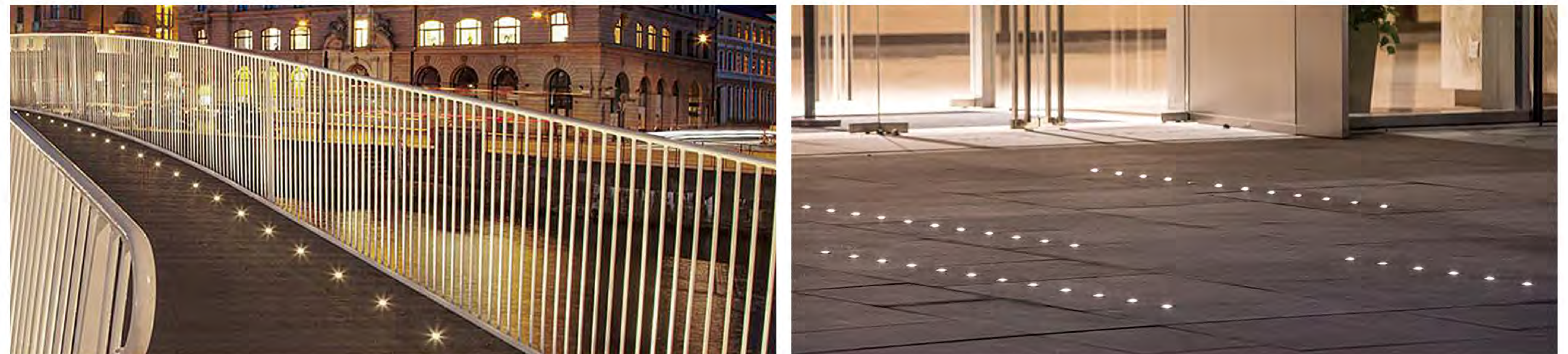

Technical Date (技术参数)

Item No.	Lamp Type	Power	LM	CCT	PF	Voltage	CRI	A	B	C (mm)
MB23-050625	LED	0.2W	14	2700K-6000K	0.6	DC24V	80-90	Ø25	34	Ø17
MB23-050623	LED	0.2W	14	2700K-6000K	0.6	DC24V	80-90	Ø23	36	Ø17
MB23-050622	LED	0.5W	35	2700K-6000K	0.6	DC24V	80-90	Ø22	55	Ø16.5
MB23-050620	LED	0.1W	7	2700K-6000K	0.6	DC24V	80-90	Ø20	30	Ø13
MB23-050615	LED	0.1W	7	2700K-6000K	0.6	DC24V	80-90	Ø15	27	Ø12
MB23-050612	LED	0.1W	7	2700K-6000K	0.6	DC24V	80-90	Ø12	35	Ø11

MB-10132



Features&Benefit (功能和优点)

Category (品类)	Underground Light
Diffuser Material (扩散器材质)	Glass
Cover Material (面盖材质)	Stainless steel
Operating mode (运行)	Built in
Steuerbar (开关)	On/Off
IP (防水等级)	65
Mounting type (安装类型)	Put
Mounting location (安装位置)	Underground
Application environment (应用环境)	Indoor/Outdoor
Cut out (预埋件)	Ø56*86mm

Product Description (产品描述)

Suitable for squares, outdoor parks, leisure places, parks, green lawns, courtyards, flower beds, pedestrian street decoration, waterfalls, fountains and other outdoor night lighting, adding luster to the environment.

Lightmap (光影图)

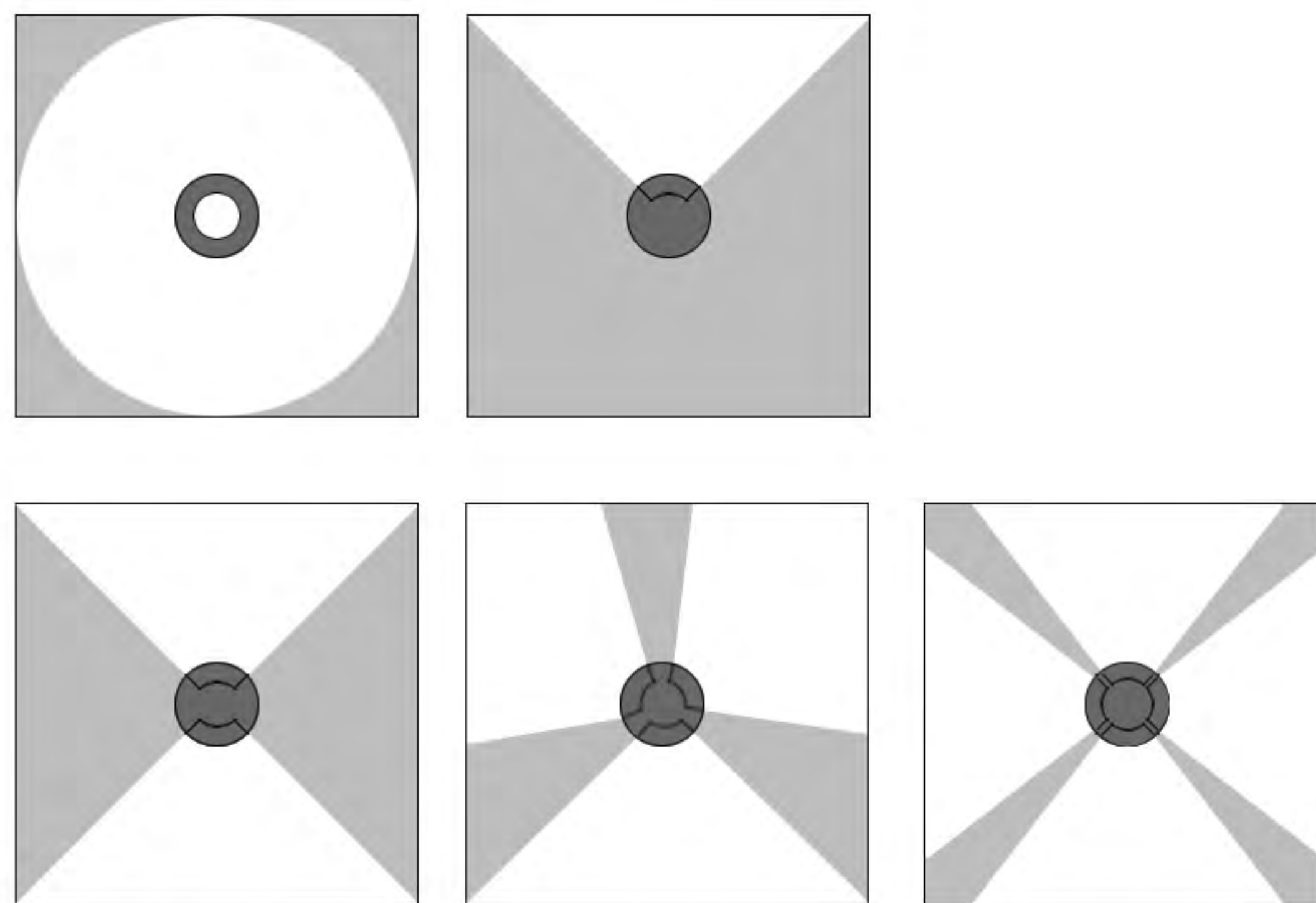

front view (正面图)



Technical Date (技术参数)

Item No.	Lamp Type	Power	LM	CCT	PF	Voltage	CRI	A	B	C (mm)
MB-10132	LED	1W	70	2700K-6000K	0.6	AC110-265V	80-90	Ø62	90	Ø56
MB-10132T1	LED	1W	70	2700K-6000K	0.6	AC110-265V	80-90	Ø62	100	Ø56
MB-10132T2	LED	1W	70	2700K-6000K	0.6	AC110-265V	80-90	Ø62	100	Ø56
MB-10132T3	LED	1W	70	2700K-6000K	0.6	AC110-265V	80-90	Ø62	100	Ø56
MB-10132T4	LED	1W	70	2700K-6000K	0.6	AC110-265V	80-90	Ø62	100	Ø56

MB-10133

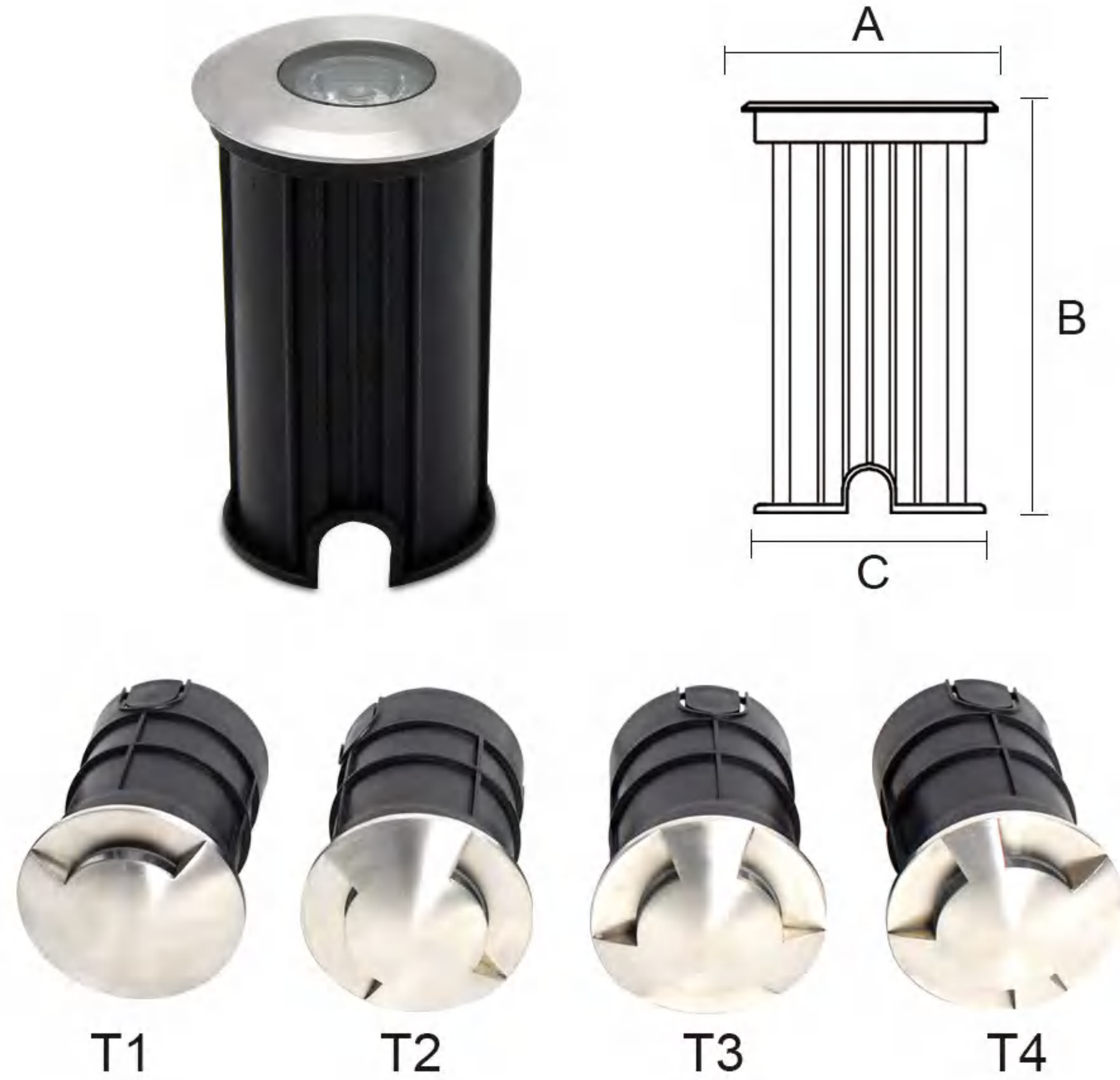

Features&Benefit (功能和优点)

Category (品类)	Underground Light
Diffuser Material (扩散器材质)	Glass
Cover Material (面盖材质)	Stainless steel
Operating mode (运行)	Built in
Steuerbar (开关)	On/Off
IP (防水等级)	65
Mounting type (安装类型)	Put
Mounting location (安装位置)	Underground
Application environment (应用环境)	Indoor/Outdoor
Cut out (预埋件)	Ø47*80mm

Product Description (产品描述)

Suitable for squares, outdoor parks, leisure places, parks, green lawns, courtyards, flower beds, pedestrian street decoration, waterfalls, fountains and other outdoor night lighting, adding luster to the environment.

Lightmap (光影图)

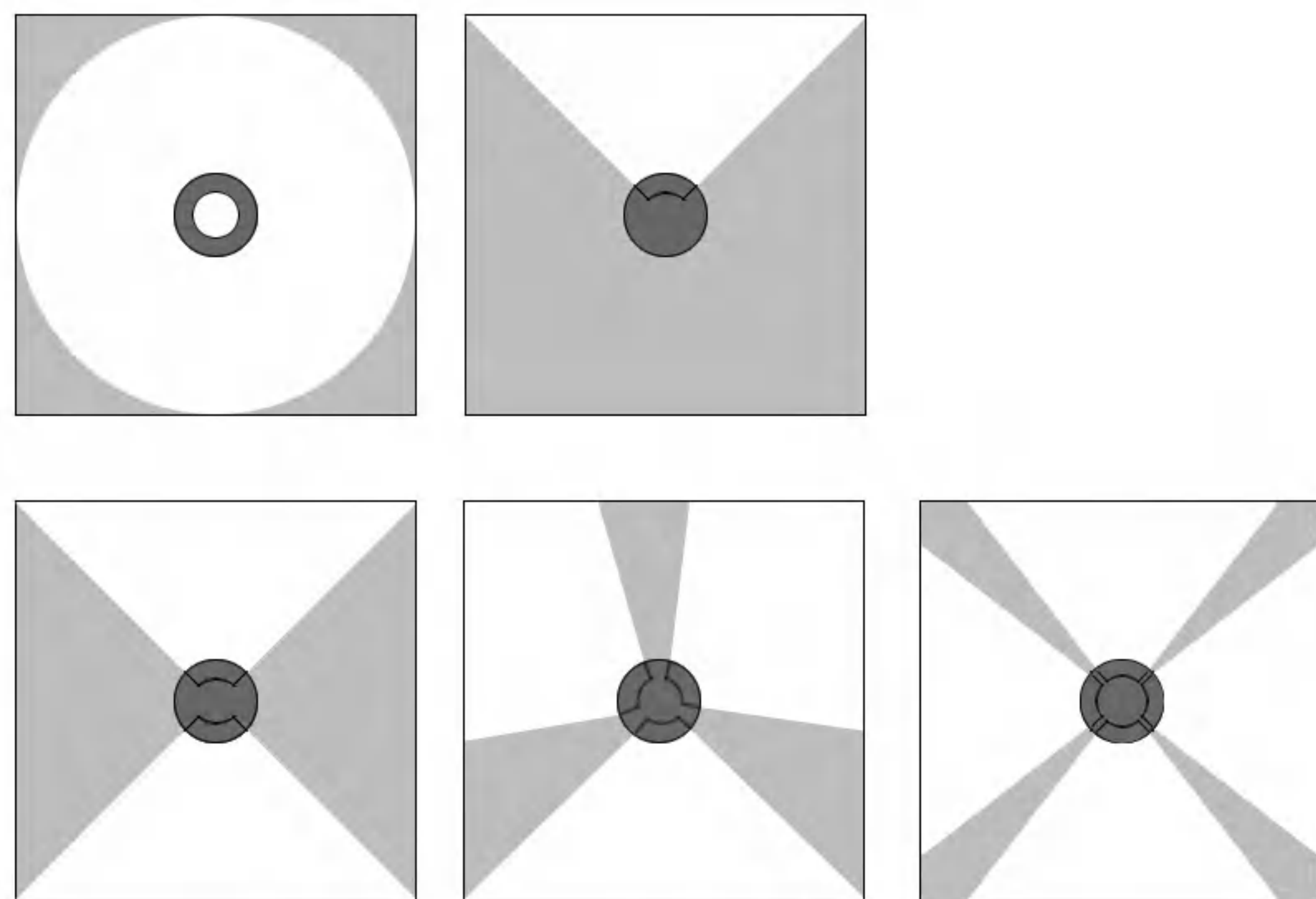

front view (正面图)



Technical Date (技术参数)

Item No.	Lamp Type	Power	LM	CCT	PF	Voltage	CRI	A	B	C (mm)
MB-10133	LED	1W	70	2700K-6000K	0.6	AC110-265V	80-90	Ø52	84	Ø47
MB-10133T1	LED	1W	70	2700K-6000K	0.6	AC110-265V	80-90	Ø52	93	Ø47
MB-10133T2	LED	1W	70	2700K-6000K	0.6	AC110-265V	80-90	Ø52	93	Ø47
MB-10133T3	LED	1W	70	2700K-6000K	0.6	AC110-265V	80-90	Ø52	93	Ø47
MB-10133T4	LED	1W	70	2700K-6000K	0.6	AC110-265V	80-90	Ø52	93	Ø47

MB-10134

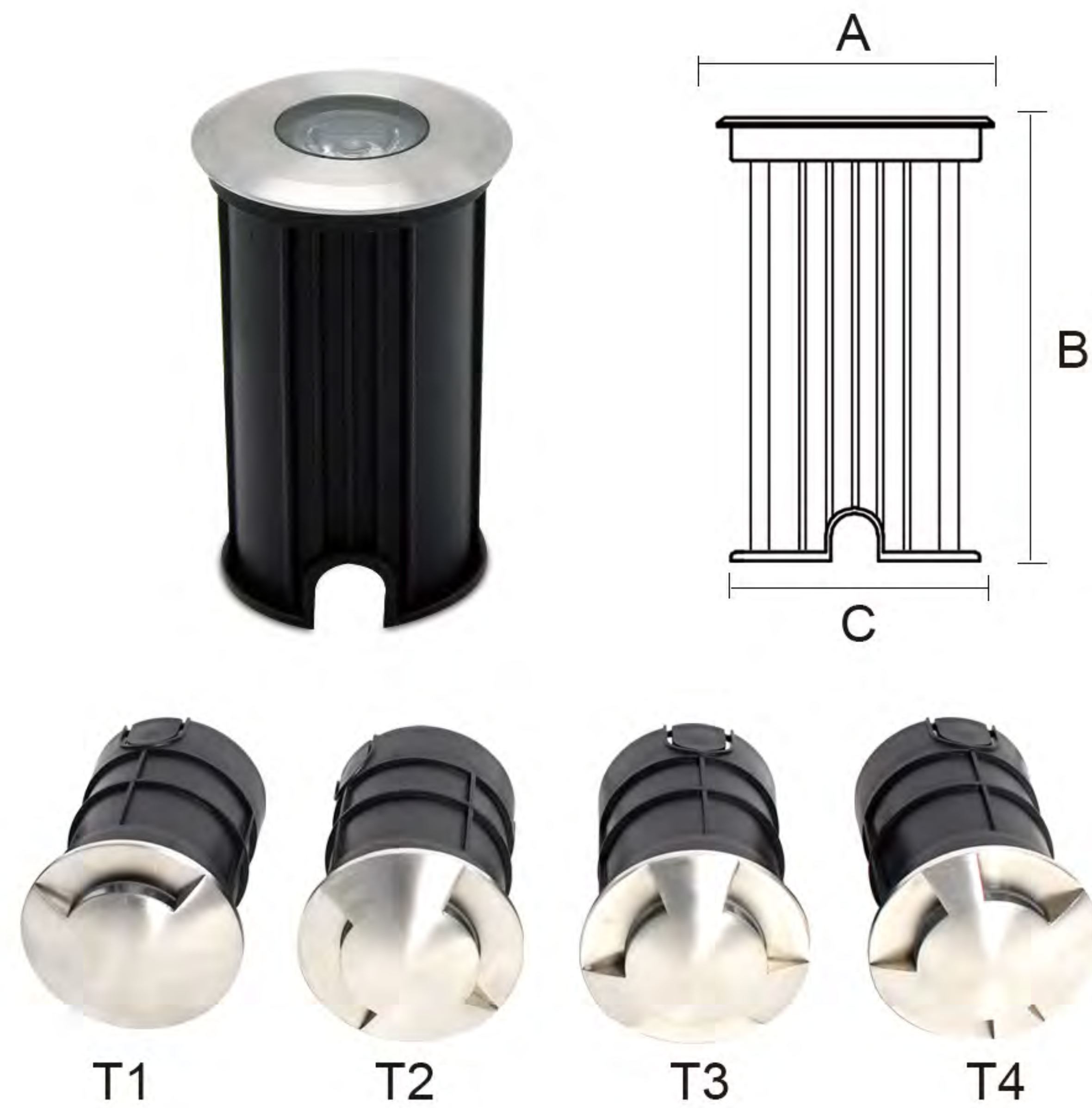

Features&Benefit (功能和优点)

Category (品类)	Underground Light
Diffuser Material (扩散器材质)	Glass
Cover Material (面盖材质)	Stainless steel
Operating mode (运行)	Built in
Steuerbar (开关)	On/Off
IP (防水等级)	65
Mounting type (安装类型)	Put
Mounting location (安装位置)	Underground
Application environment (应用环境)	Indoor/Outdoor
Cut out (预埋件)	Ø38*70mm

Product Description (产品描述)

Suitable for squares, outdoor parks, leisure places, parks, green lawns, courtyards, flower beds, pedestrian street decoration, waterfalls, fountains and other outdoor night lighting, adding luster to the environment.

Lightmap (光影图)

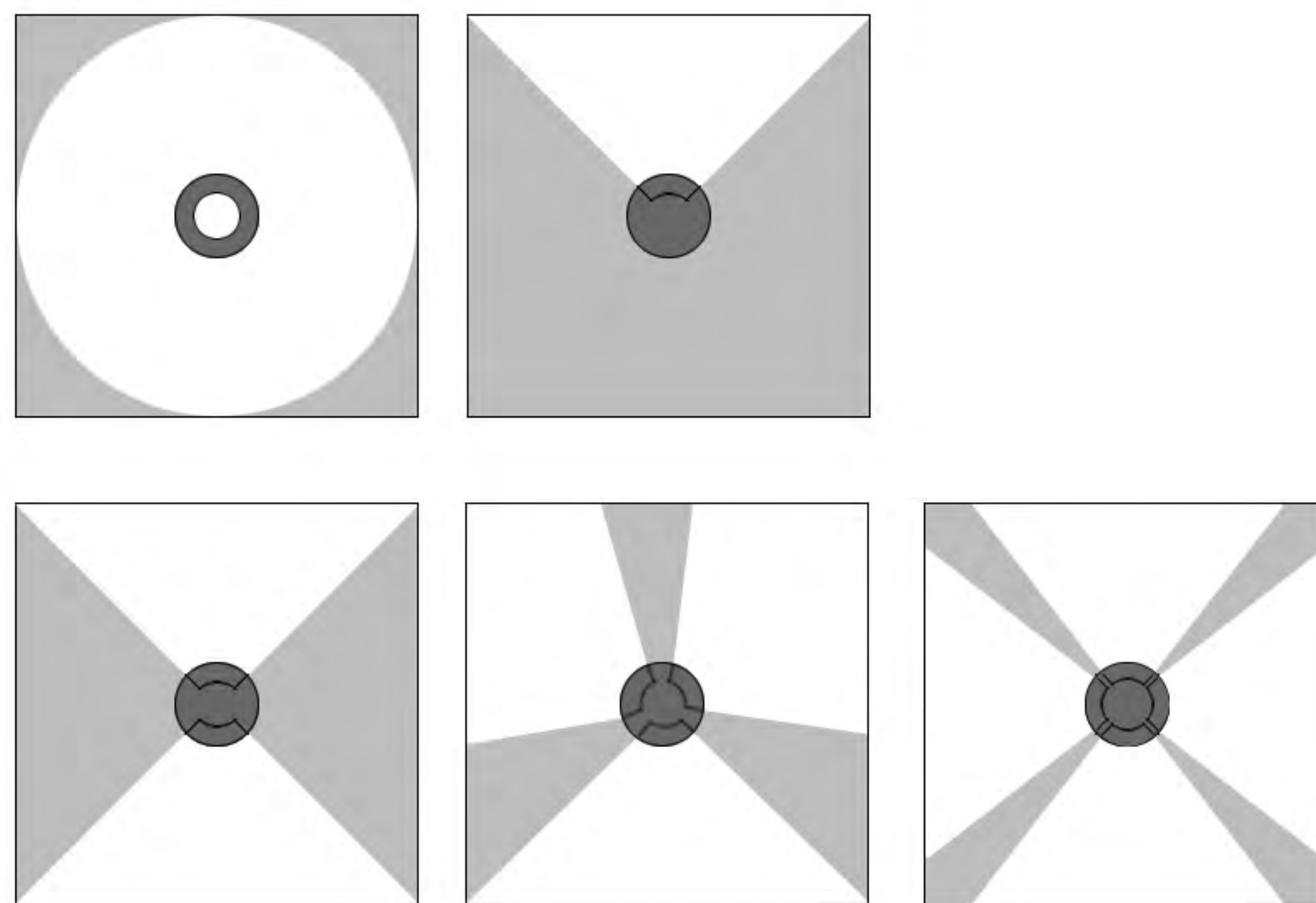

front view (正面图)

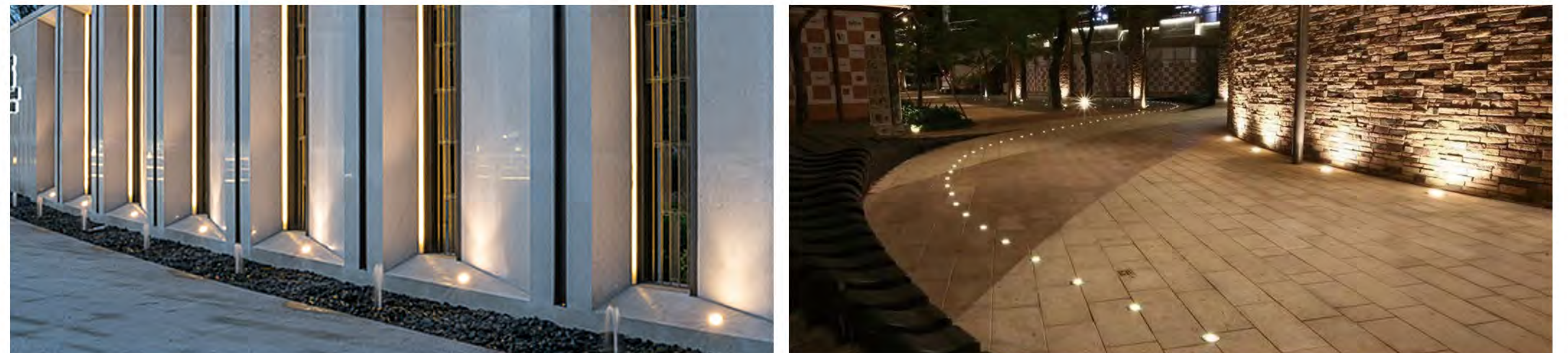

Technical Date (技术参数)

Item No.	Lamp Type	Power	LM	CCT	PF	Voltage	CRI	A	B	C (mm)
MB-10134	LED	1W	70	2700K-6000K	0.6	AC110-265V	80-90	Ø42	74	Ø38
MB-10134T1	LED	1W	70	2700K-6000K	0.6	AC110-265V	80-90	Ø42	82	Ø38
MB-10134T2	LED	1W	70	2700K-6000K	0.6	AC110-265V	80-90	Ø42	82	Ø38
MB-10134T3	LED	1W	70	2700K-6000K	0.6	AC110-265V	80-90	Ø42	82	Ø38
MB-10134T4	LED	1W	70	2700K-6000K	0.6	AC110-265V	80-90	Ø42	82	Ø38

MB-D001

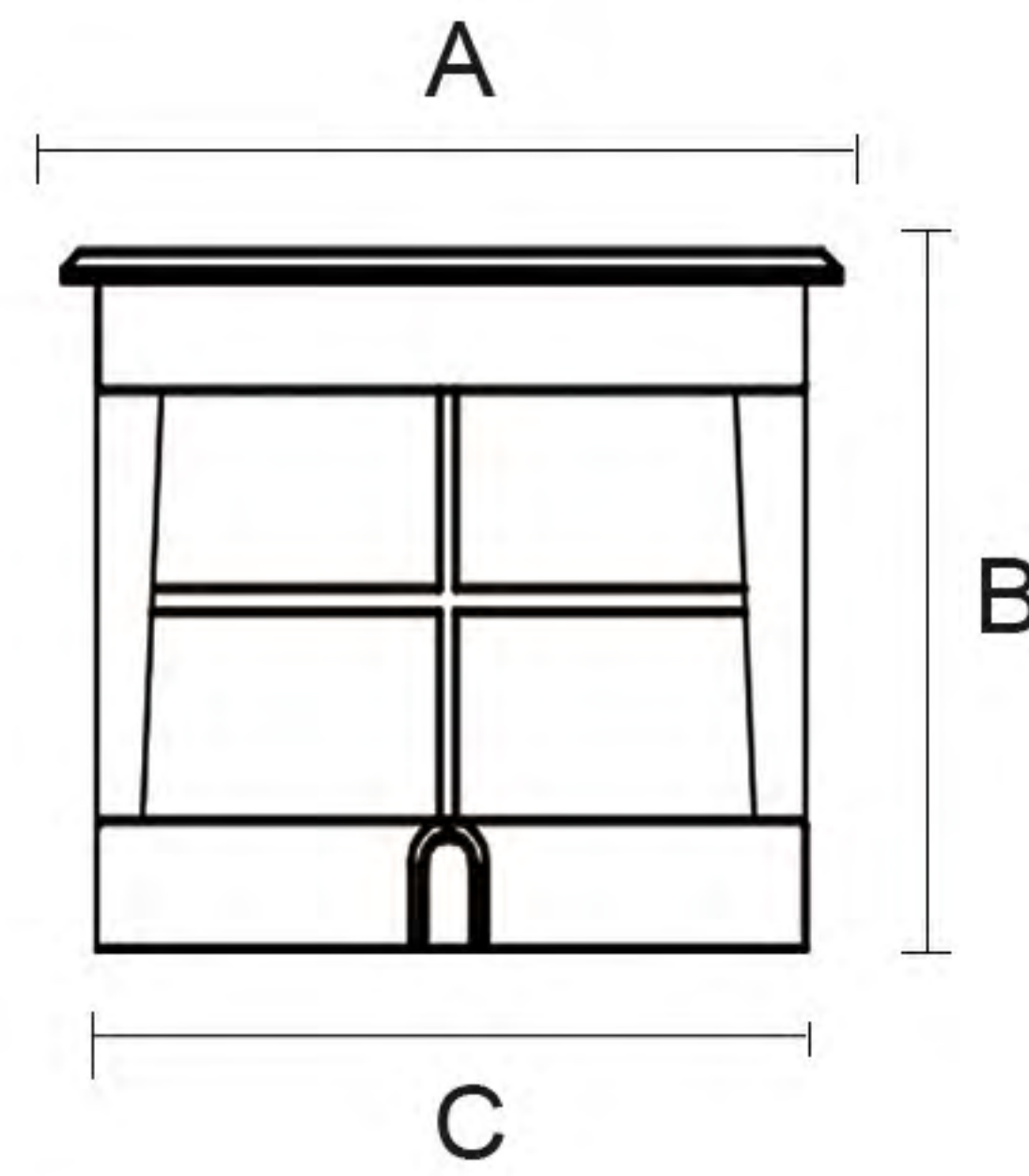

Features&Benefit (功能和优点)

Category (品类)	Underground Light
Diffuser Material (扩散器材质)	Glass
Cover Material (面盖材质)	Aluminum+Stainless steel
Operating mode (运行)	Built in
Steuerbar (开关)	On/Off
IP (防水等级)	65
Mounting type (安装类型)	Put
Mounting location (安装位置)	Underground
Application environment (应用环境)	Indoor/Outdoor
Cut out (预埋件)	Ø148*118mm/Ø168*118mm/Ø198*118mm

Product Description (产品描述)

Suitable for squares, outdoor parks, leisure places, parks, green lawns, courtyards, flower beds, pedestrian street decoration, waterfalls, fountains and other outdoor night lighting, adding luster to the environment.

Lightmap (光影图)

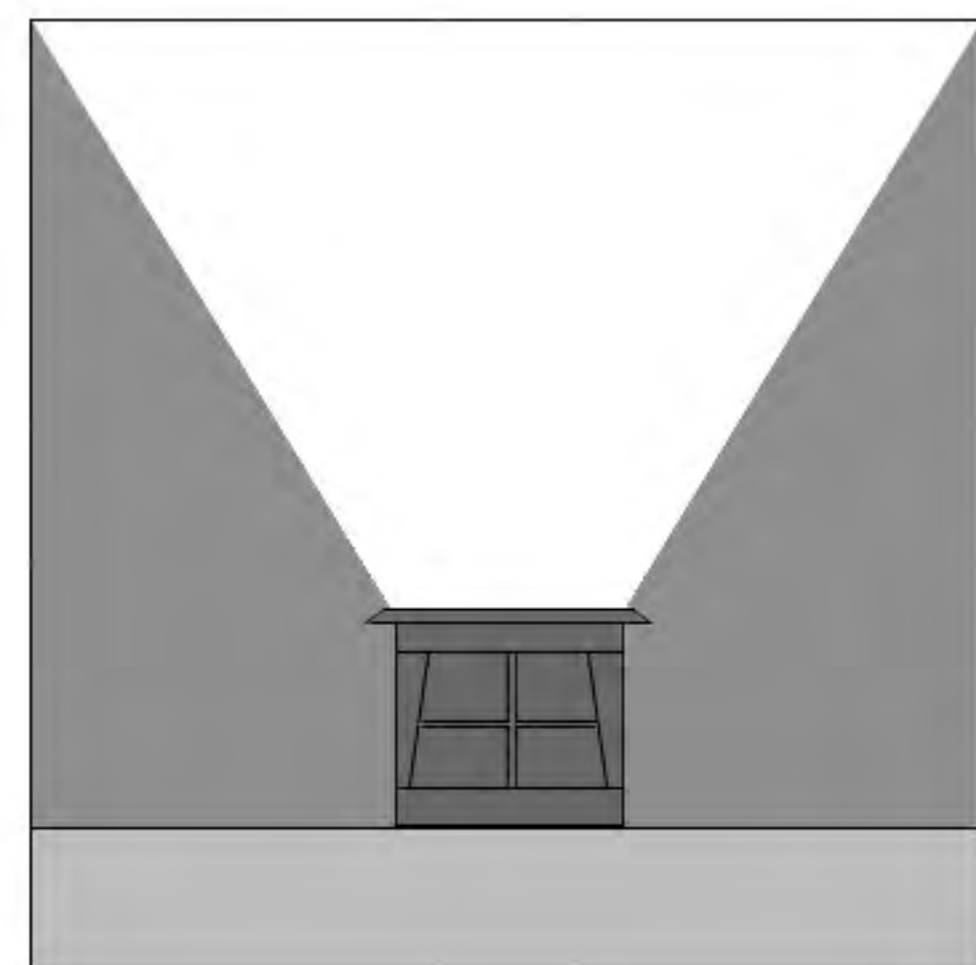

front view (正面图)

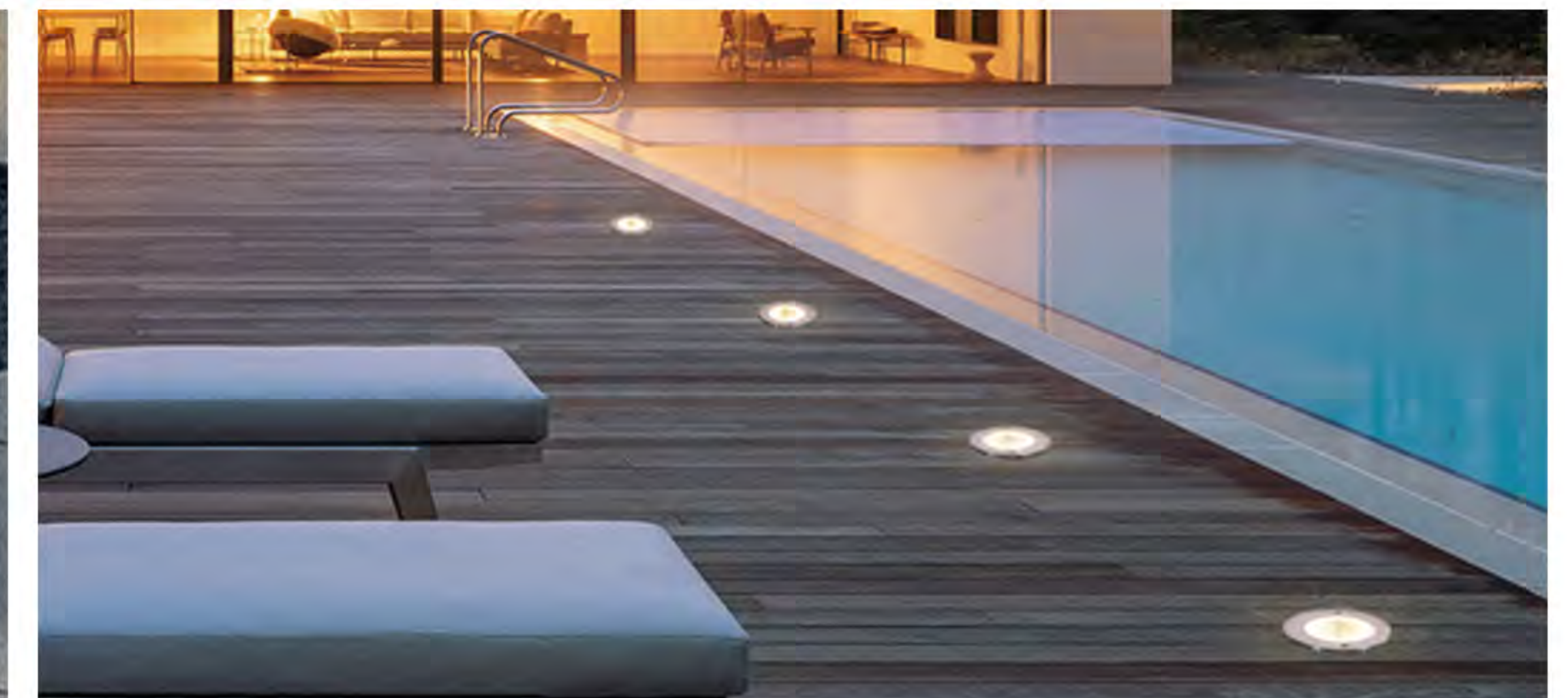

Technical Date (技术参数)

Item No.	Lamp Type	Power	LM	CCT	PF	Voltage	CRI	A	B	C (mm)
MB-D001	LED	10W	70	2700K-6000K	0.6	AC110-265V	80-90	Ø150	120	Ø148
MB-D002	LED	15W	1050	2700K-6000K	0.6	AC110-265V	80-90	Ø180	120	Ø168
MB-D003	LED	20W	1400	2700K-6000K	0.9	AC110-265V	80-90	Ø210	120	Ø198

MB-D011

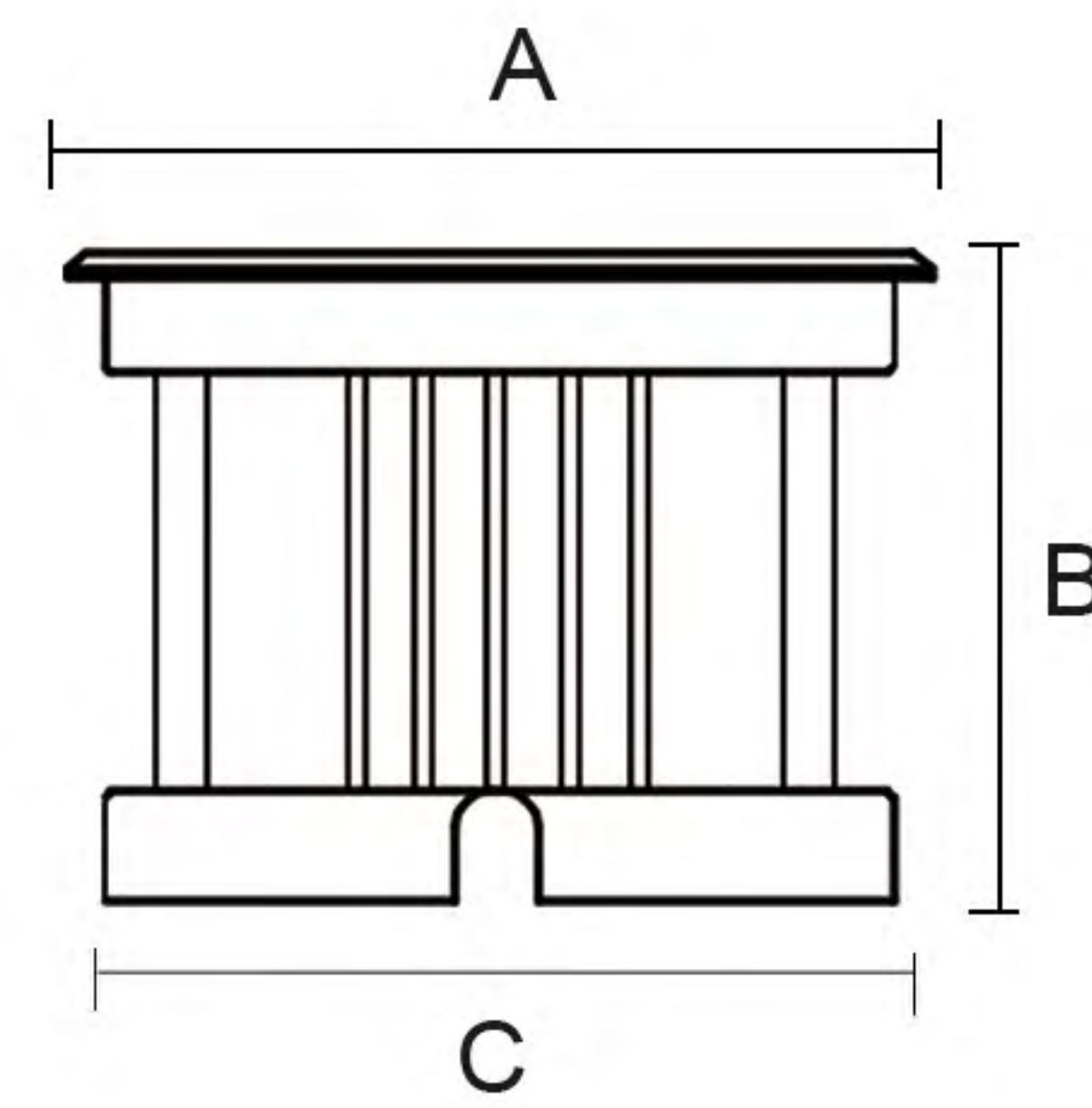

Features&Benefit (功能和优点)

Category (品类)	Underground Light
Diffuser Material (扩散器材质)	Glass
Cover Material (面盖材质)	Aluminum+Stainless steel
Operating mode (运行)	Built in
Steuerbar (开关)	On/Off
IP (防水等级)	67
Mounting type (安装类型)	Put
Mounting location (安装位置)	Underground
Application environment (应用环境)	Indoor/Outdoor
Cut out (预埋件)	Ø90*72mm

Product Description (产品描述)

Suitable for squares, outdoor parks, leisure places, parks, green lawns, courtyards, flower beds, pedestrian street decoration, waterfalls, fountains and other outdoor night lighting, adding luster to the environment.

Lightmap (光影图)

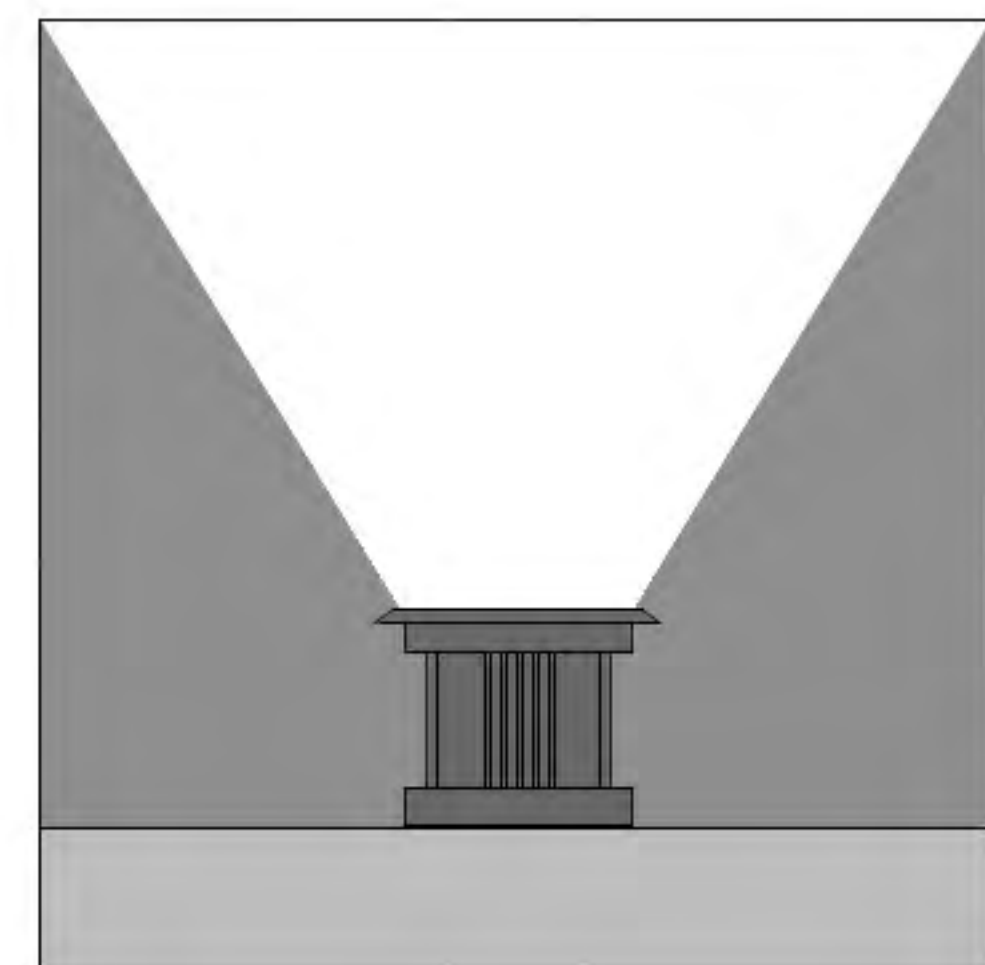

front view (正面图)



Technical Date (技术参数)

Item No.	Lamp Type	Power	LM	CCT	PF	Voltage	CRI	A	B	C (mm)
MB-D011	LED	3W	210	2700K-6000K	0.6	AC110-265V	80-90	Ø100	75	Ø90

MB-D012



Features&Benefit (功能和优点)

Category (品类)	Underground Light
Diffuser Material (扩散器材质)	Glass
Cover Material (面盖材质)	Aluminum+Stainless steel
Operating mode (运行)	Built in
Steuerbar (开关)	On/Off
IP (防水等级)	67
Mounting type (安装类型)	Put
Mounting location (安装位置)	Underground
Application environment (应用环境)	Indoor/Outdoor
Cut out (预埋件)	Ø145*100mm/Ø168*118mm Ø200*118mm/Ø240*118mm/Ø290*102mm

Product Description (产品描述)

Suitable for squares, outdoor parks, leisure places, parks, green lawns, courtyards, flower beds, pedestrian street decoration, waterfalls, fountains and other outdoor night lighting, adding luster to the environment.

Lightmap (光影图)

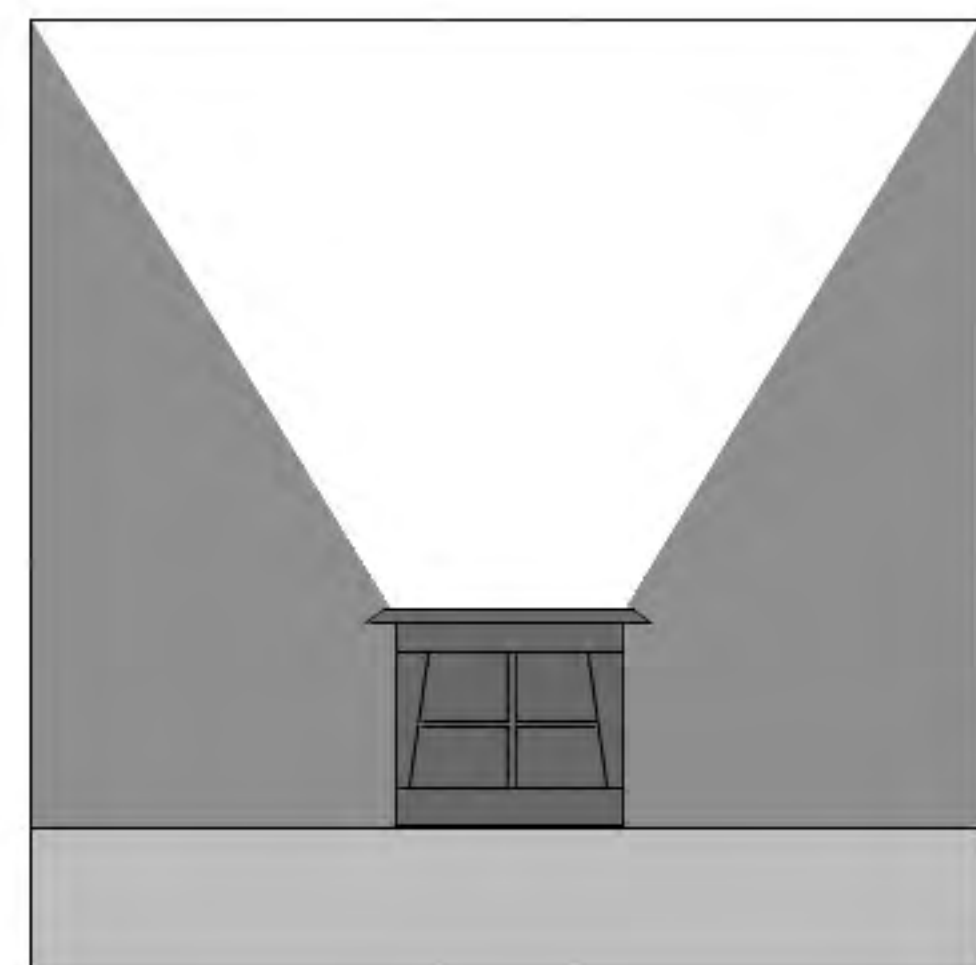

front view (正面图)

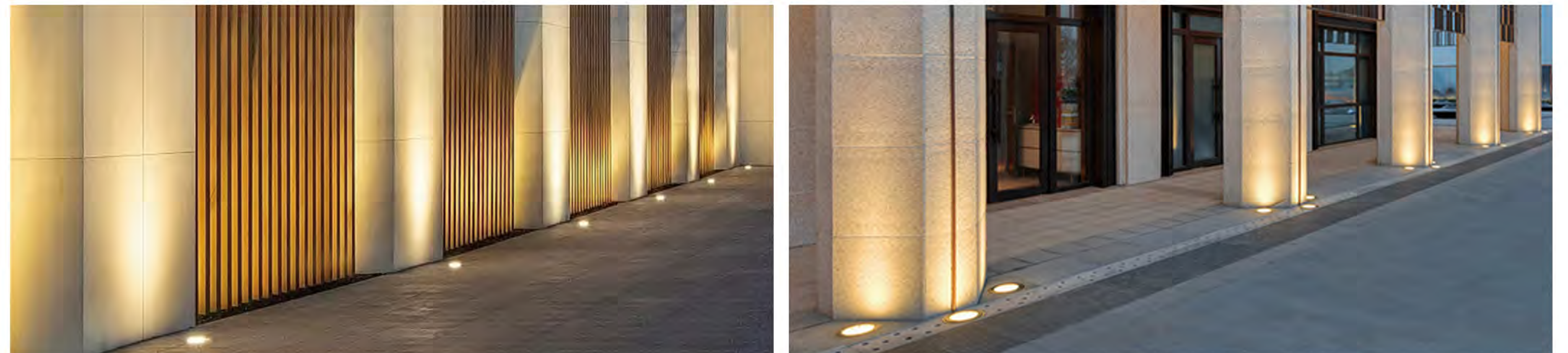

Technical Date (技术参数)

Item No.	Lamp Type	Power	LM	CCT	PF	Voltage	CRI	A	B	C (mm)
MB-D012	LED	9W	630	2700K-6000K	0.6	AC110-265V	80-90	Ø160	105	Ø145
MB-D013	LED	12W	840	2700K-6000K	0.6	AC110-265V	80-90	Ø180	118	Ø168
MB-D014	LED	18W	1260	2700K-6000K	0.6	AC110-265V	80-90	Ø210	118	Ø200
MB-D015	LED	24W	1680	2700K-6000K	0.9	AC110-265V	80-90	Ø260	118	Ø240
MB-D016	LED	36W	2520	2700K-6000K	0.9	AC110-265V	80-90	Ø320	105	Ø290

MB-D017

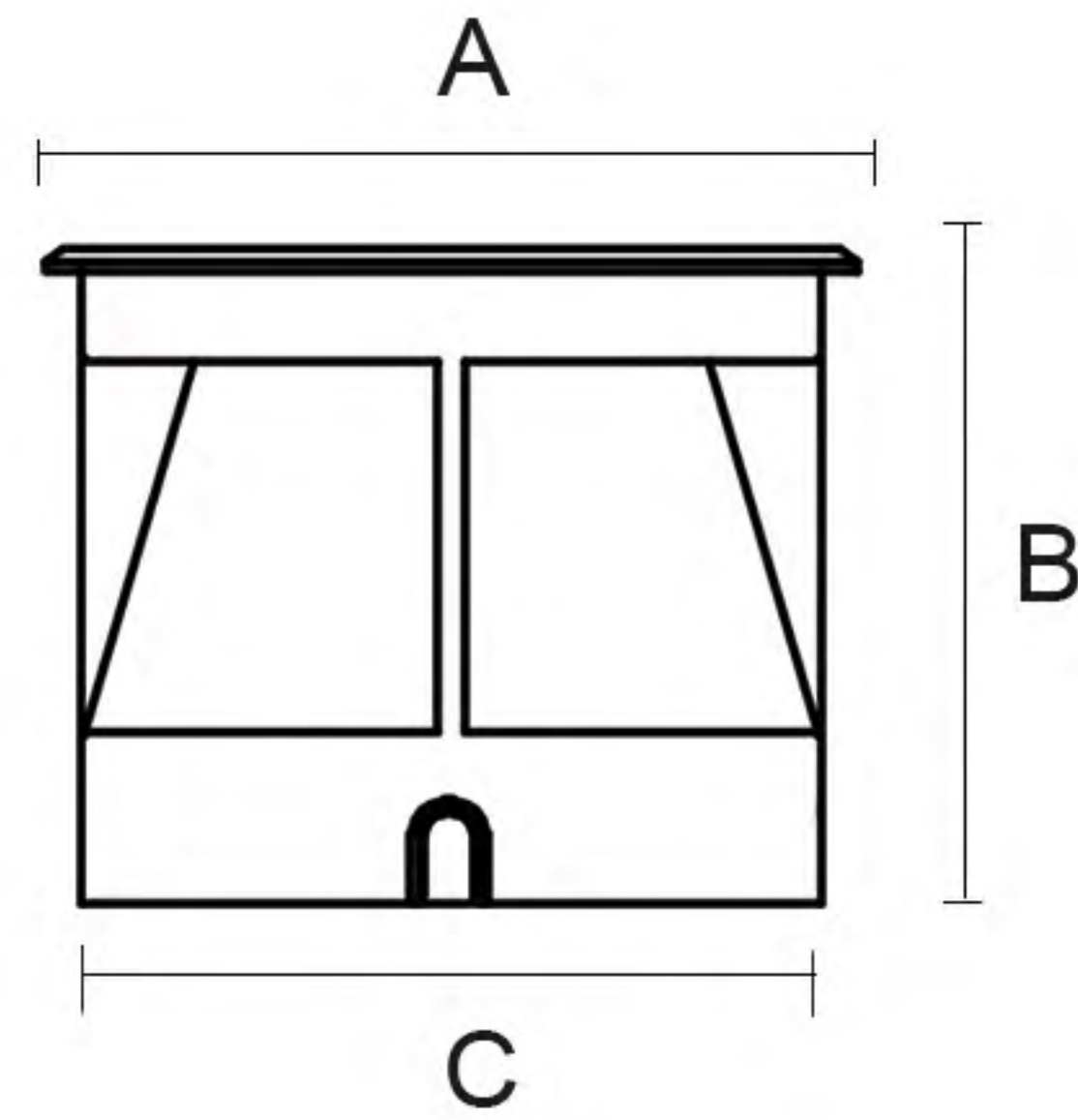

Features&Benefit (功能和优点)

Category (品类)	Underground Light
Diffuser Material (扩散器材质)	Glass
Cover Material (面盖材质)	Aluminum+Stainless steel
Operating mode (运行)	Built in
Steuerbar (开关)	On/Off
IP (防水等级)	67
Mounting type (安装类型)	Put
Mounting location (安装位置)	Underground
Application environment (应用环境)	Indoor/Outdoor
Cut out (预埋件)	Ø150*140mm/Ø175*125mm Ø198*140mm/Ø245*140mm

Product Description (产品描述)

Suitable for squares, outdoor parks, leisure places, parks, green lawns, courtyards, flower beds, pedestrian street decoration, waterfalls, fountains and other outdoor night lighting, adding luster to the environment.

Lightmap (光影图)

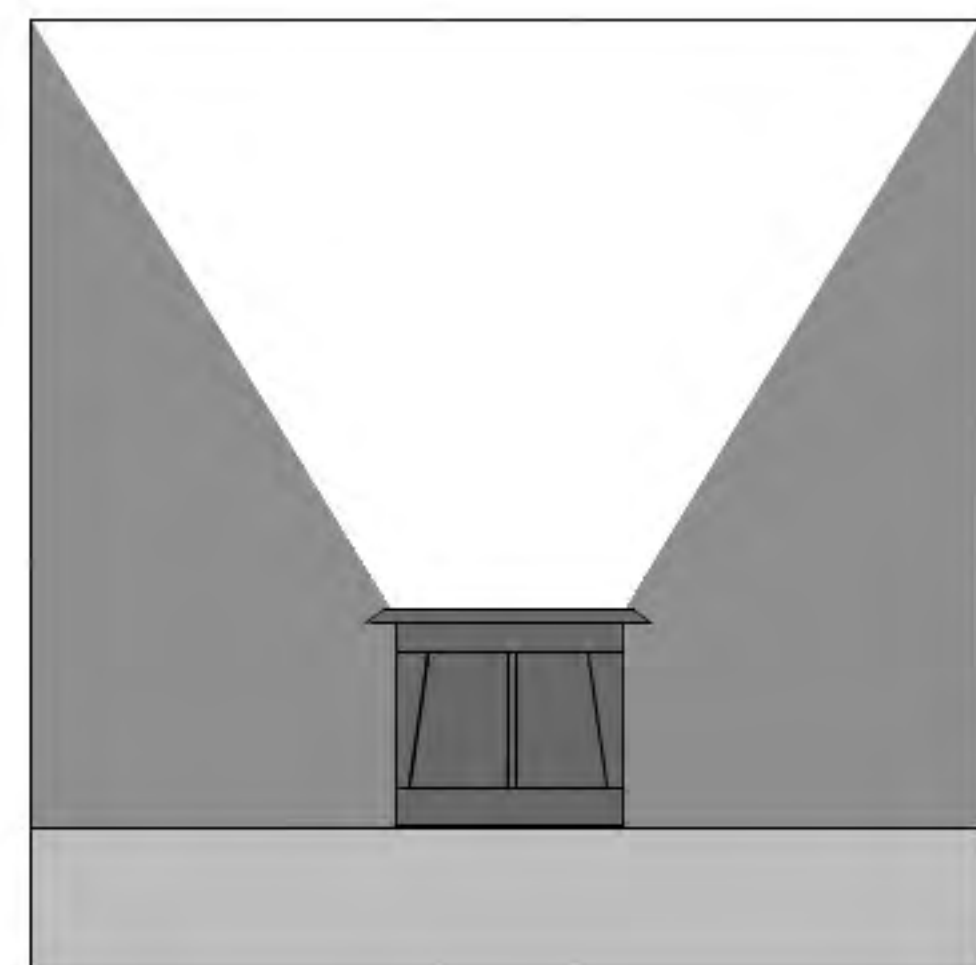

front view (正面图)

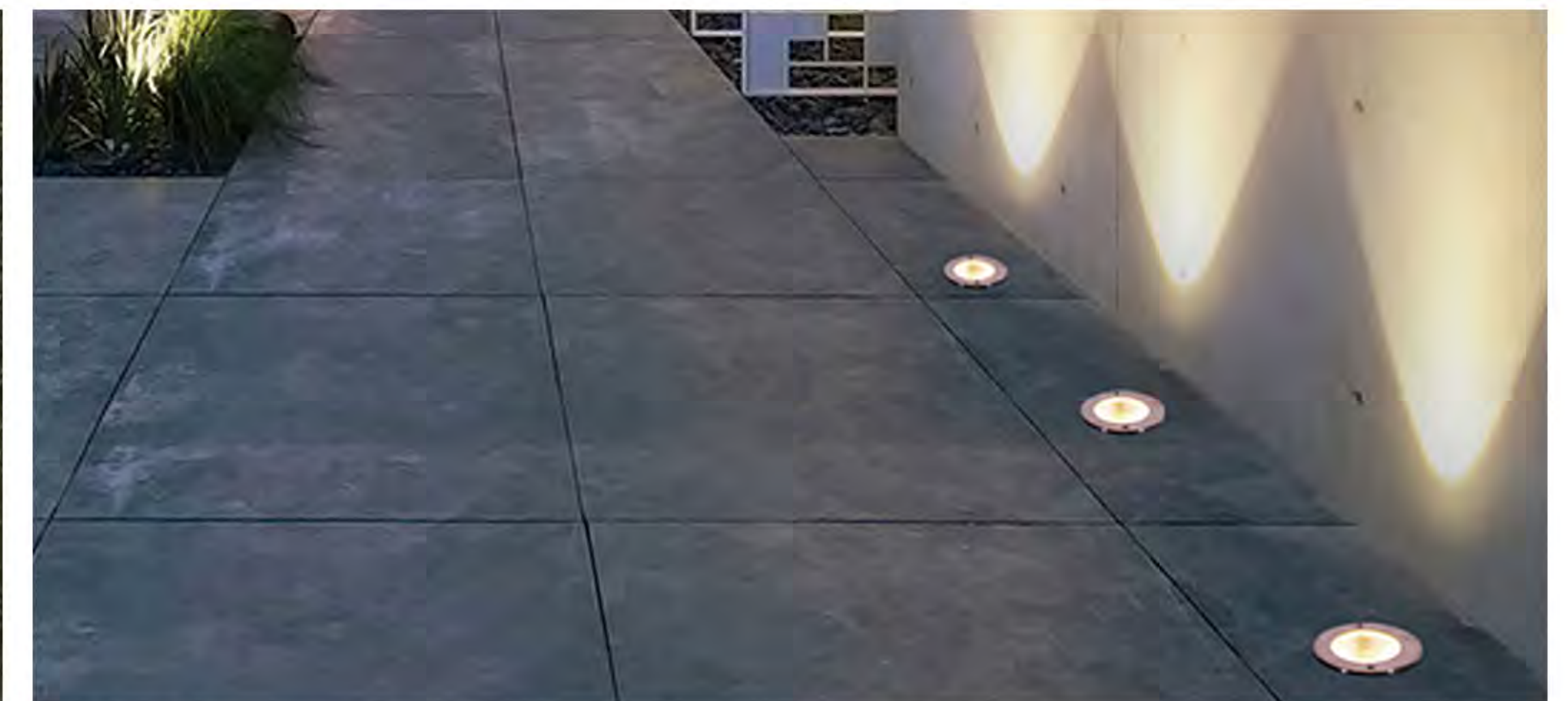
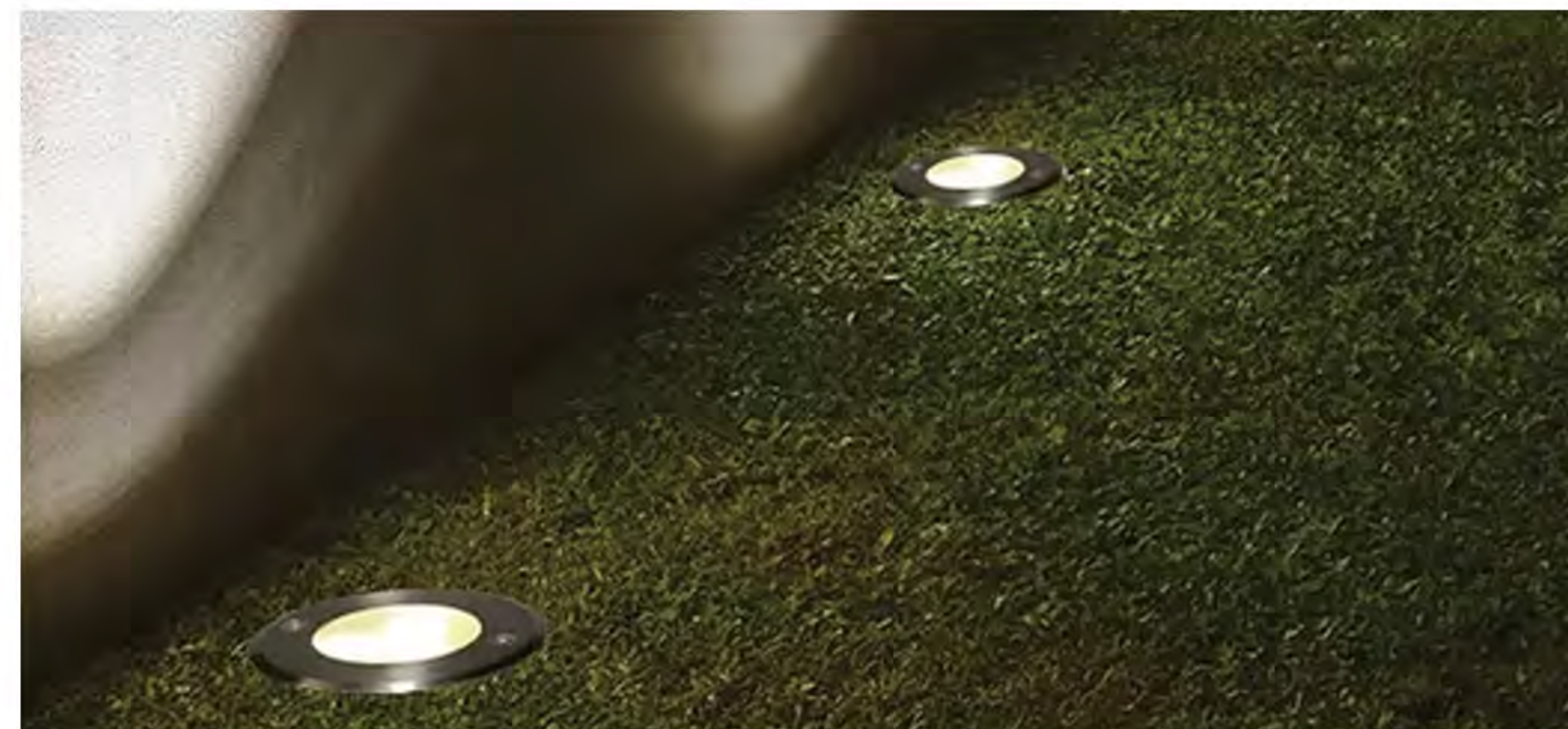

Technical Date (技术参数)

Item No.	Lamp Type	Power	LM	CCT	PF	Voltage	CRI	A	B	C (mm)
MB-D017	LED	15W	1050	2700K-6000K	0.6	AC110-265V	80-90	Ø160	145	Ø150
MB-D018	LED	20W	1400	2700K-6000K	0.9	AC110-265V	80-90	Ø180	130	Ø175
MB-D019	LED	30W	2100	2700K-6000K	0.9	AC110-265V	80-90	Ø210	145	Ø198
MB-D020	LED	50W	3500	2700K-6000K	0.9	AC110-265V	80-90	Ø270	145	Ø245

MB-D021

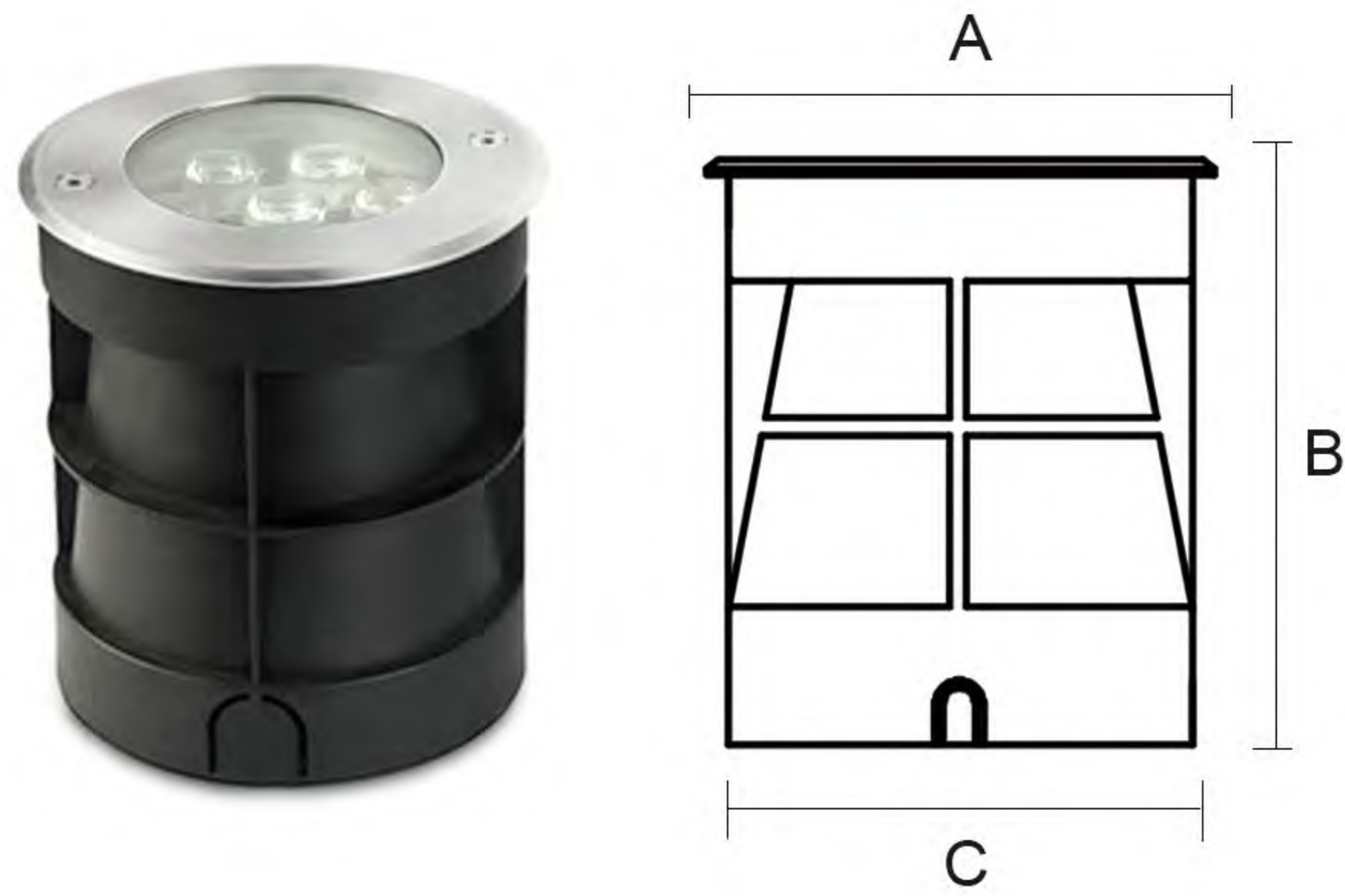

Features&Benefit (功能和优点)

Category (品类)	Underground Light
Diffuser Material (扩散器材质)	Glass
Cover Material (面盖材质)	Aluminum+Stainless steel
Operating mode (运行)	Built in
Steuerbar (开关)	On/Off
IP (防水等级)	67
Mounting type (安装类型)	Put
Mounting location (安装位置)	Underground
Application environment (应用环境)	Indoor/Outdoor
Cut out (预埋件)	Ø125*140mm

Product Description (产品描述)

Suitable for squares, outdoor parks, leisure places, parks, green lawns, courtyards, flower beds, pedestrian street decoration, waterfalls, fountains and other outdoor night lighting, adding luster to the environment.

Lightmap (光影图)

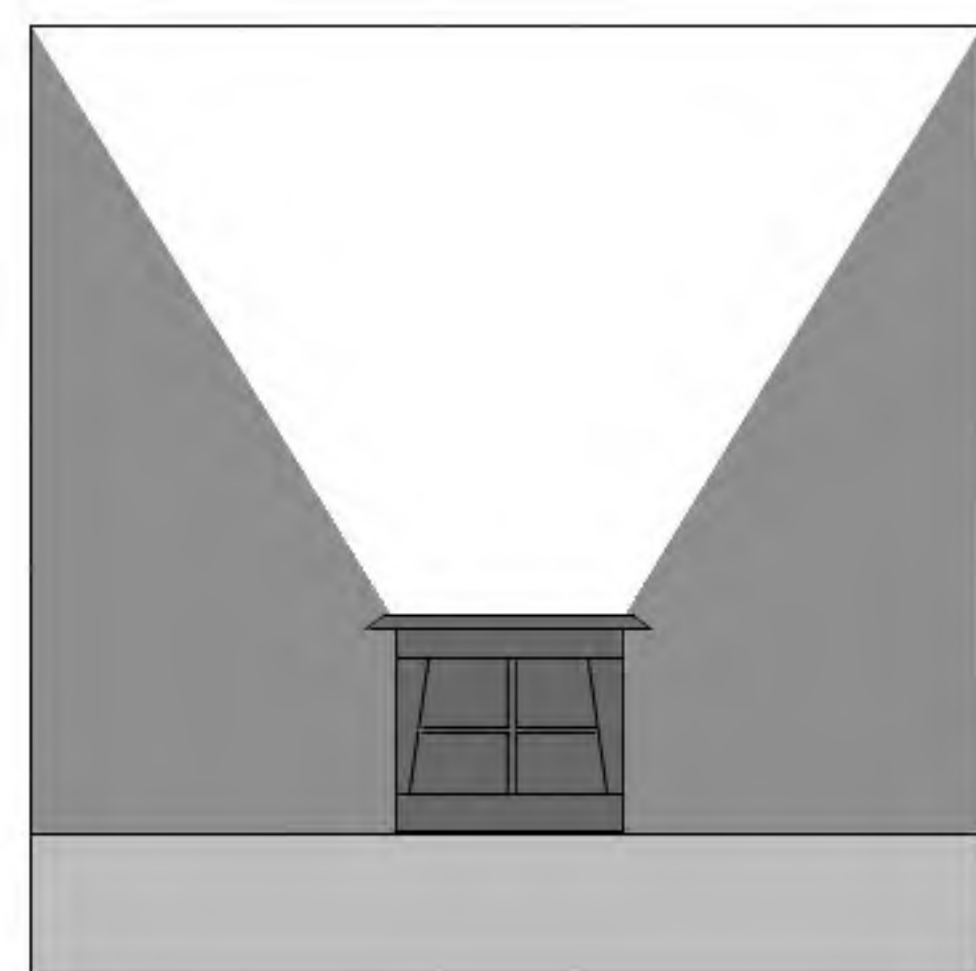

front view (正面图)

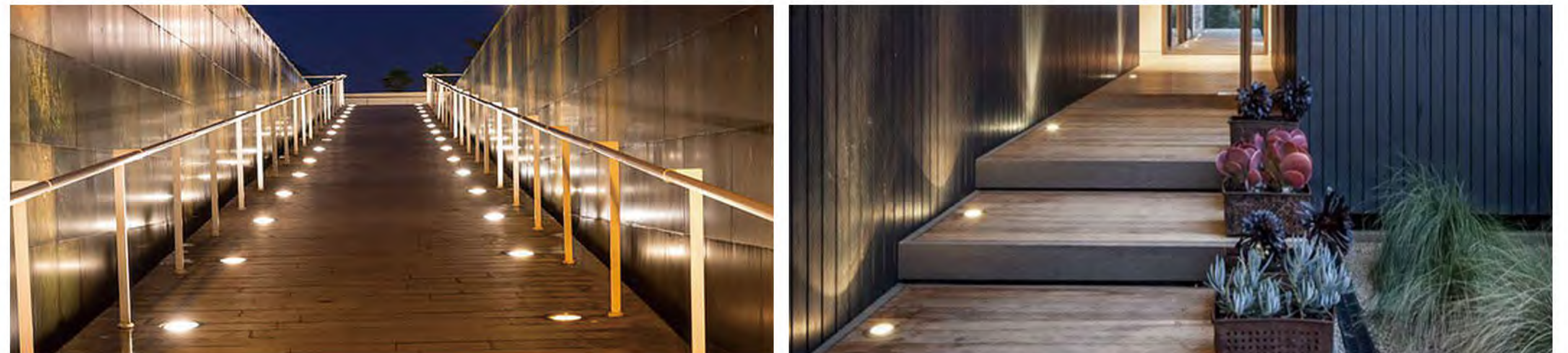

Technical Date (技术参数)

Item No.	Lamp Type	Power	LM	CCT	PF	Voltage	CRI	A	B	C (mm)
MB-D021	LED	7W	490	2700K-6000K	0.6	AC110-265V	80-90	Ø130	145	Ø125

MB-D022

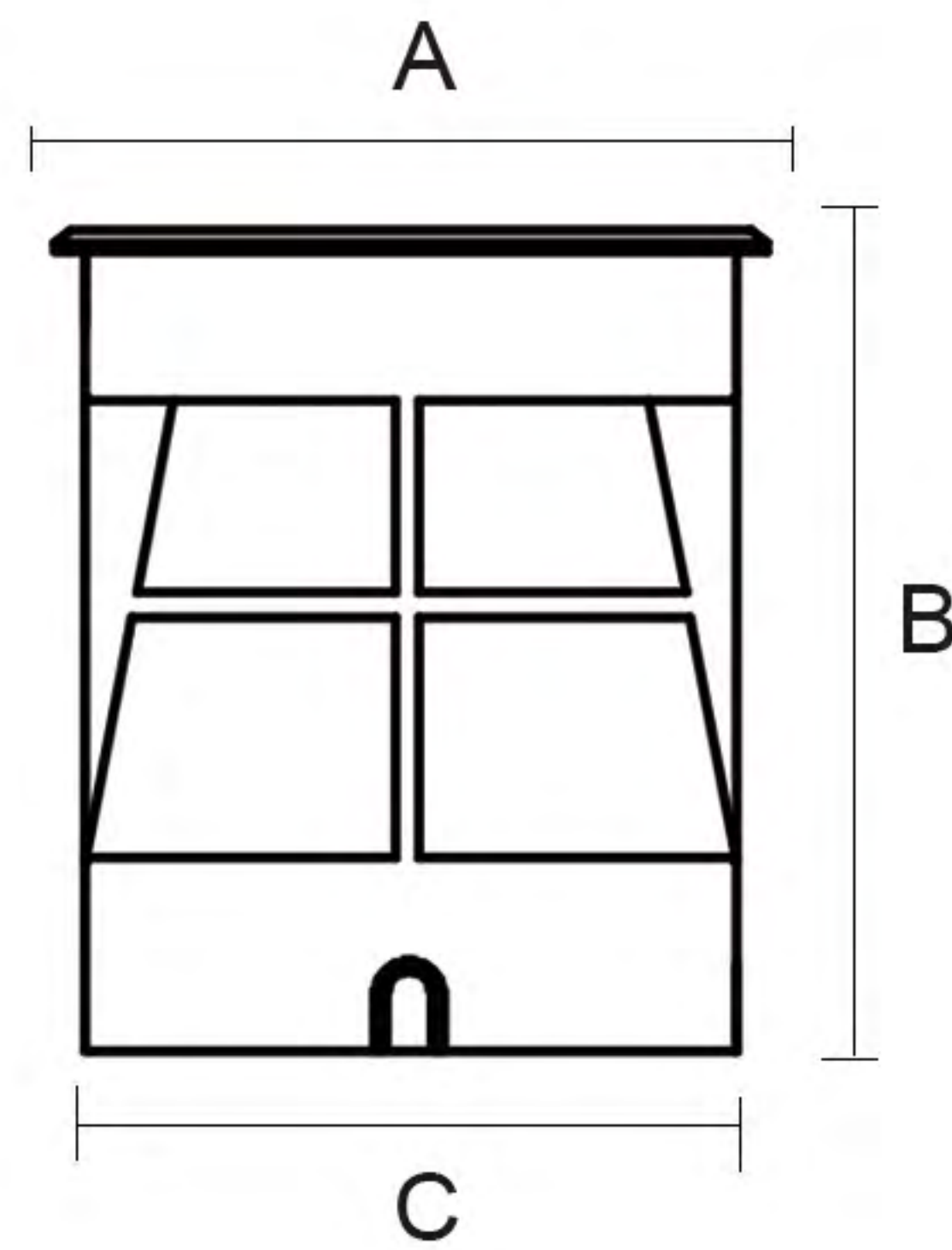

Features&Benefit (功能和优点)

Category (品类)	Underground Light
Diffuser Material (扩散器材质)	Glass
Cover Material (面盖材质)	Aluminum+Stainless steel
Operating mode (运行)	Built in
Steuerbar (开关)	On/Off
IP (防水等级)	67
Mounting type (安装类型)	Put
Mounting location (安装位置)	Underground
Application environment (应用环境)	Indoor/Outdoor
Cut out (预埋件)	Ø150*180mm/Ø170*180mm

Product Description (产品描述)

Suitable for squares, outdoor parks, leisure places, parks, green lawns, courtyards, flower beds, pedestrian street decoration, waterfalls, fountains and other outdoor night lighting, adding luster to the environment.

Lightmap (光影图)

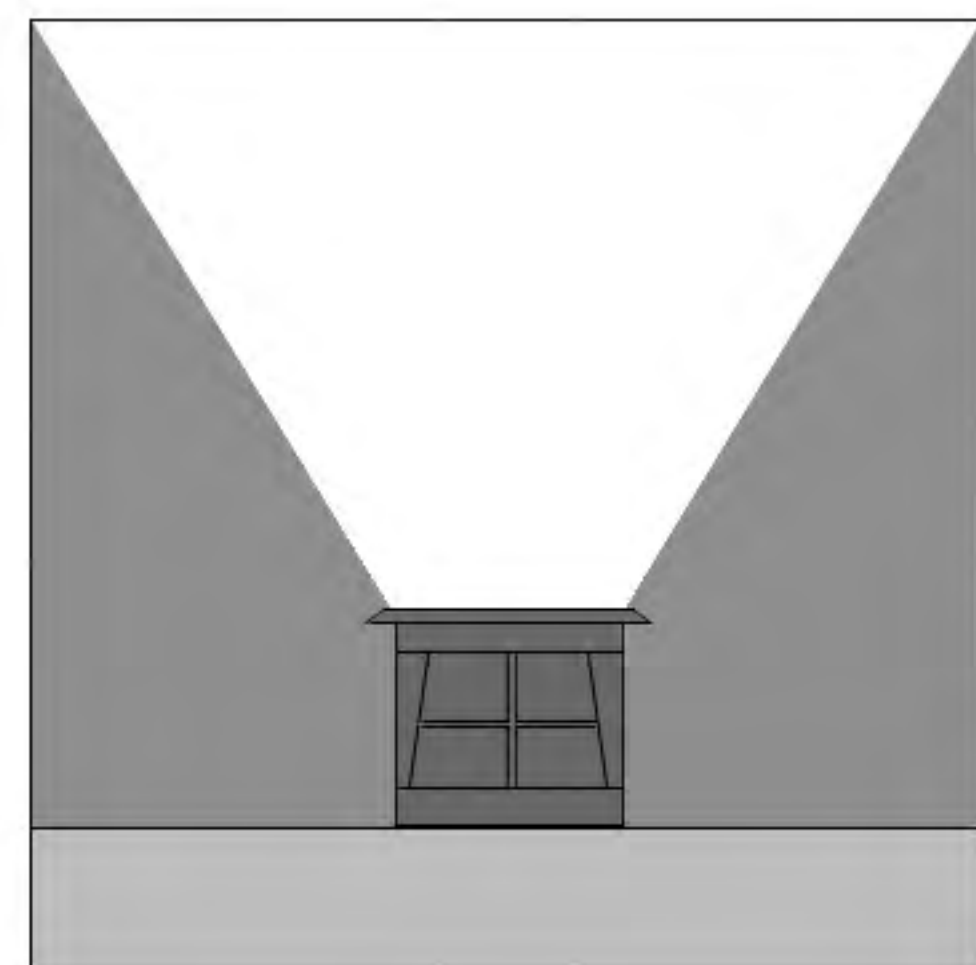

front view (正面图)



Technical Date (技术参数)

Item No.	Lamp Type	Power	LM	CCT	PF	Voltage	CRI	A	B	C (mm)
MB-D022	LED	15W	1050	2700K-6000K	0.6	AC110-265V	80-90	Ø160	185	Ø150
MB-D023	LED	20W	1400	2700K-6000K	0.9	AC110-265V	80-90	Ø180	185	Ø170

MB-D024

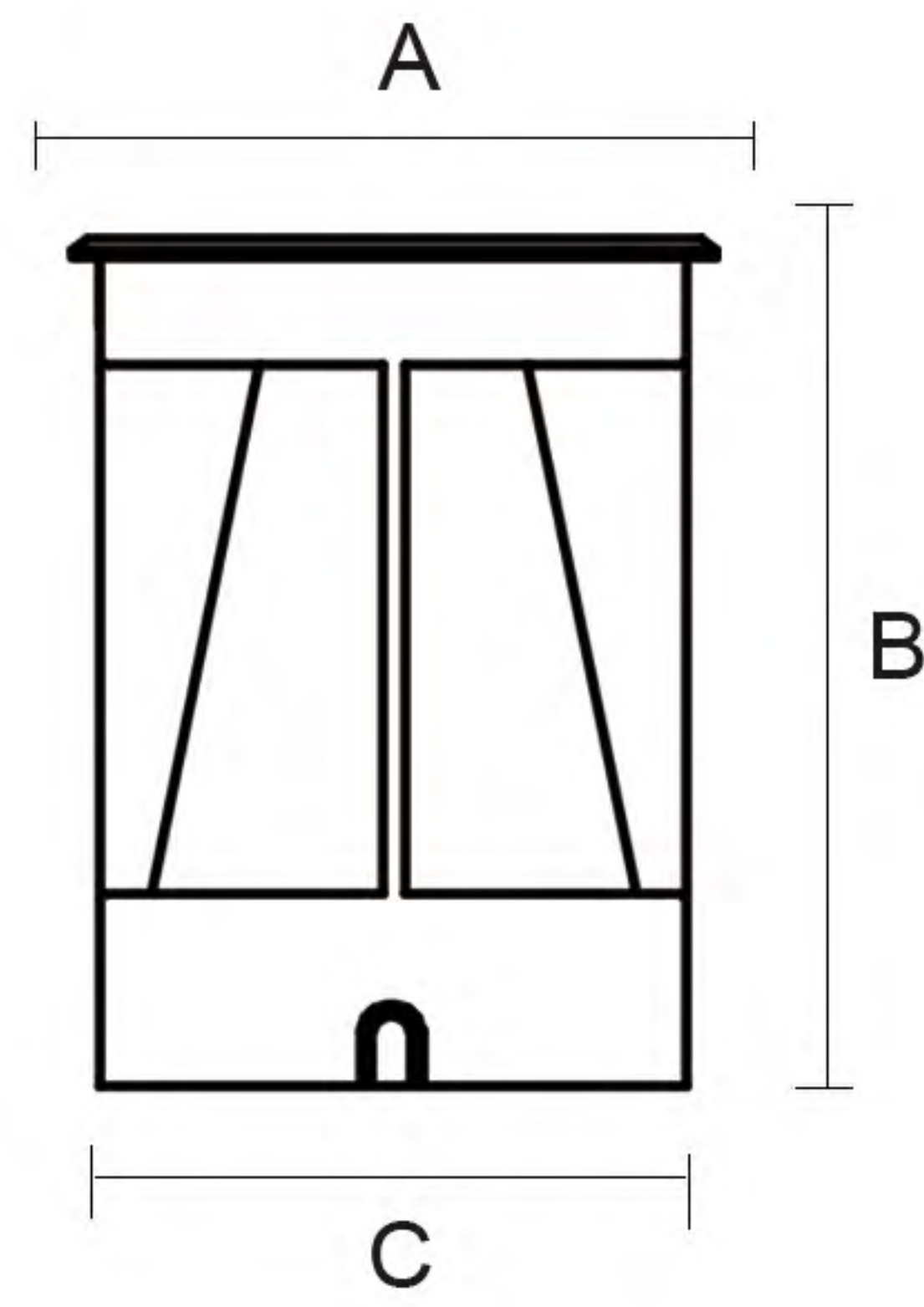

Features&Benefit (功能和优点)

Category (品类)	Underground Light
Diffuser Material (扩散器材质)	Glass
Cover Material (面盖材质)	Aluminum+Stainless steel
Operating mode (运行)	Built in
Steuerbar (开关)	On/Off
IP (防水等级)	67
Mounting type (安装类型)	Put
Mounting location (安装位置)	Underground
Application environment (应用环境)	Indoor/Outdoor
Cut out (预埋件)	Ø92*120mm

Product Description (产品描述)

Suitable for squares, outdoor parks, leisure places, parks, green lawns, courtyards, flower beds, pedestrian street decoration, waterfalls, fountains and other outdoor night lighting, adding luster to the environment.

Lightmap (光影图)

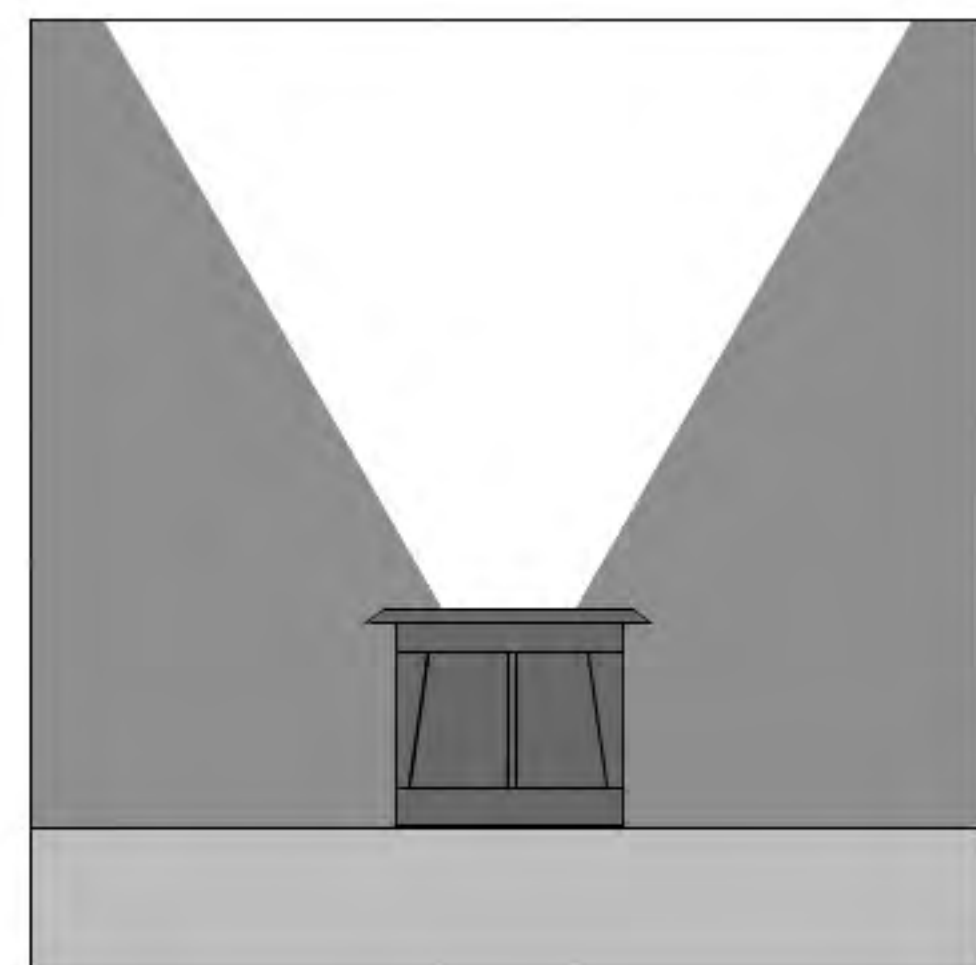

front view (正面图)

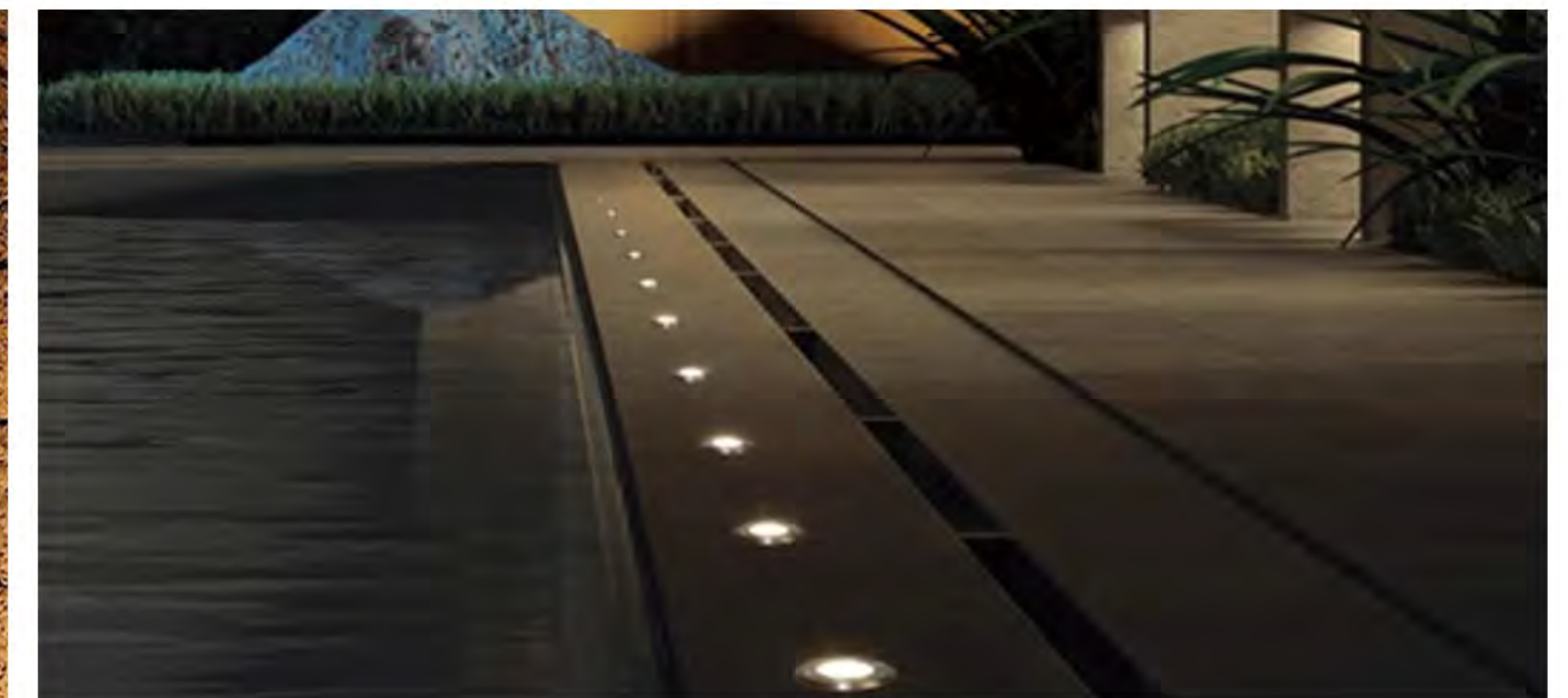

Technical Date (技术参数)

Item No.	Lamp Type	Power	LM	CCT	PF	Voltage	CRI	A	B	C (mm)
MB-D024	LED	3W	210	2700K-6000K	0.6	AC110-265V	80-90	Ø100	125	Ø92

MB-D025

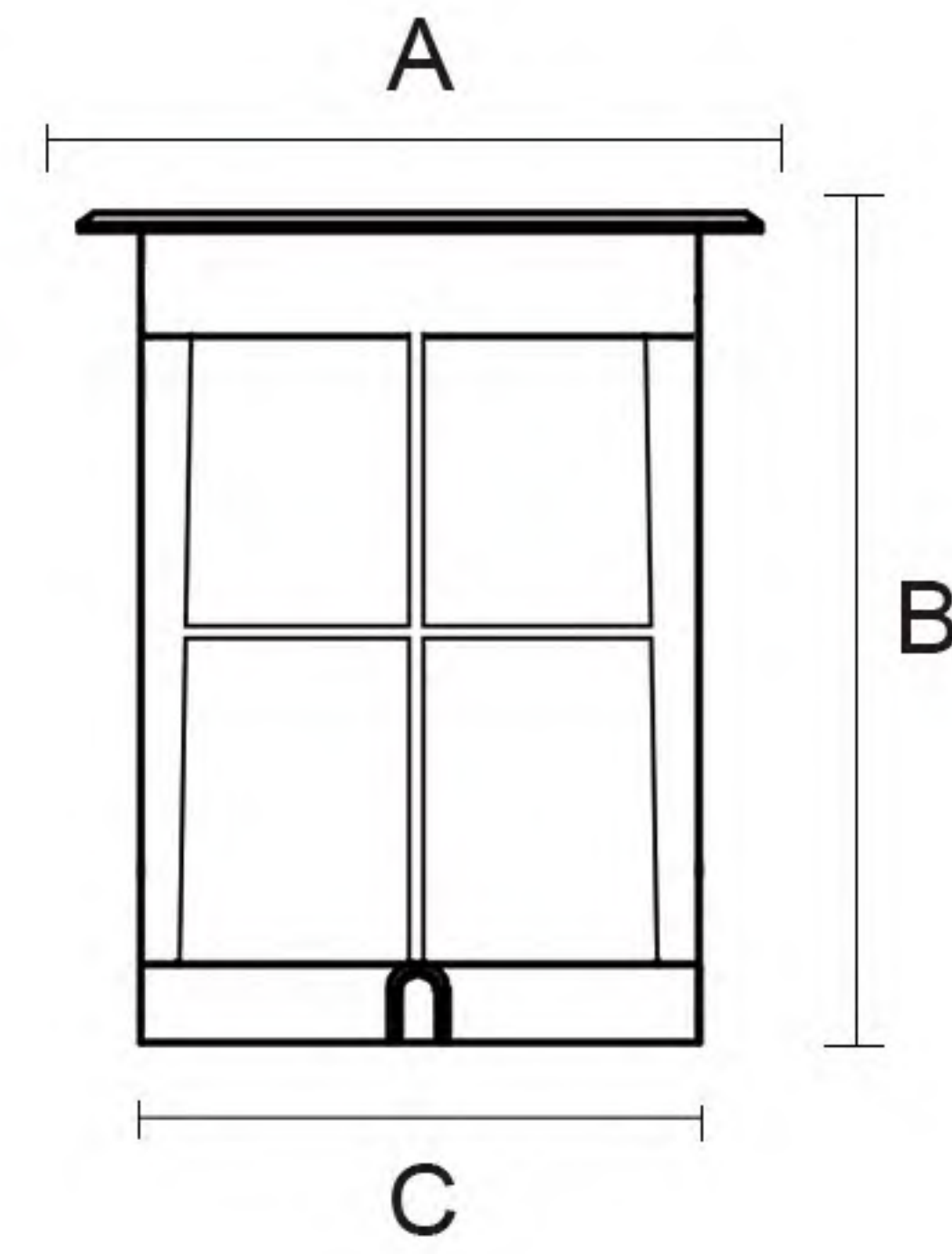

Features&Benefit (功能和优点)

Category (品类)	Underground Light
Diffuser Material (扩散器材质)	Glass
Cover Material (面盖材质)	Aluminum+Stainless steel
Operating mode (运行)	Built in
Steuerbar (开关)	On/Off
IP (防水等级)	67
Mounting type (安装类型)	Put
Mounting location (安装位置)	Underground
Application environment (应用环境)	Indoor/Outdoor
Cut out (预埋件)	Ø108*85mm

Product Description (产品描述)

Suitable for squares, outdoor parks, leisure places, parks, green lawns, courtyards, flower beds, pedestrian street decoration, waterfalls, fountains and other outdoor night lighting, adding luster to the environment.

Lightmap (光影图)

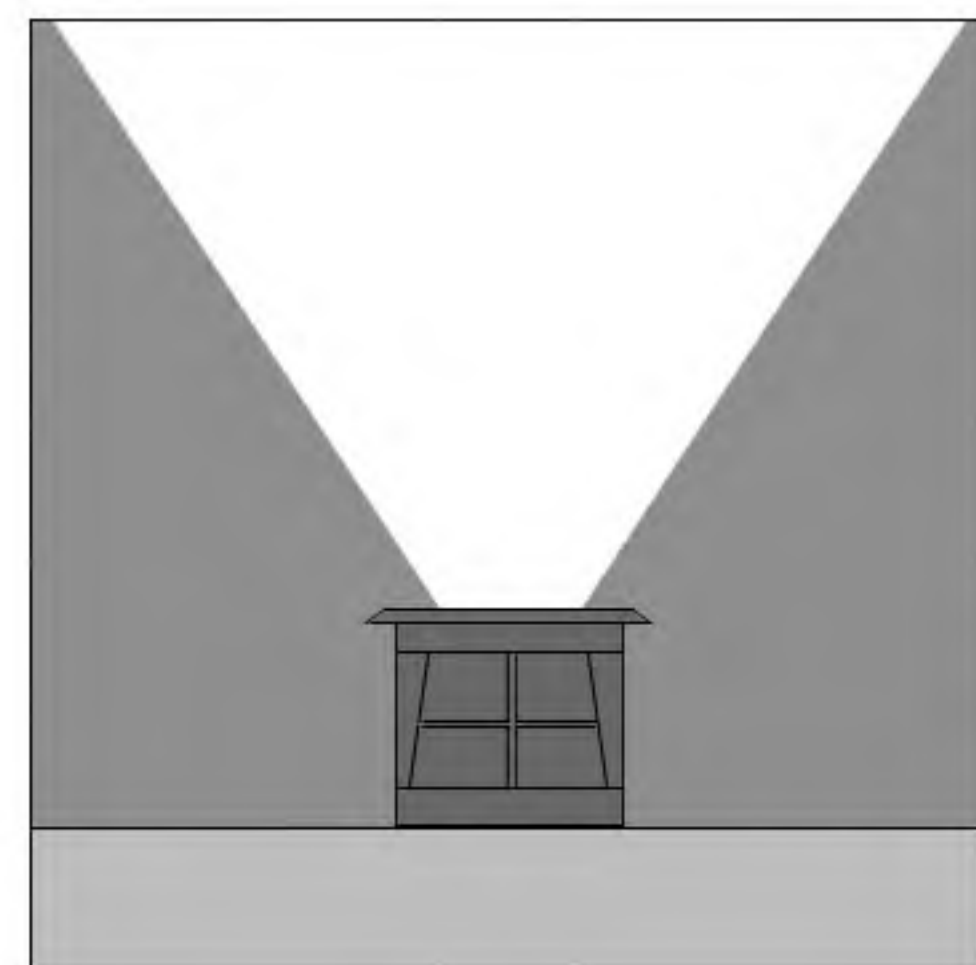

front view (正面图)

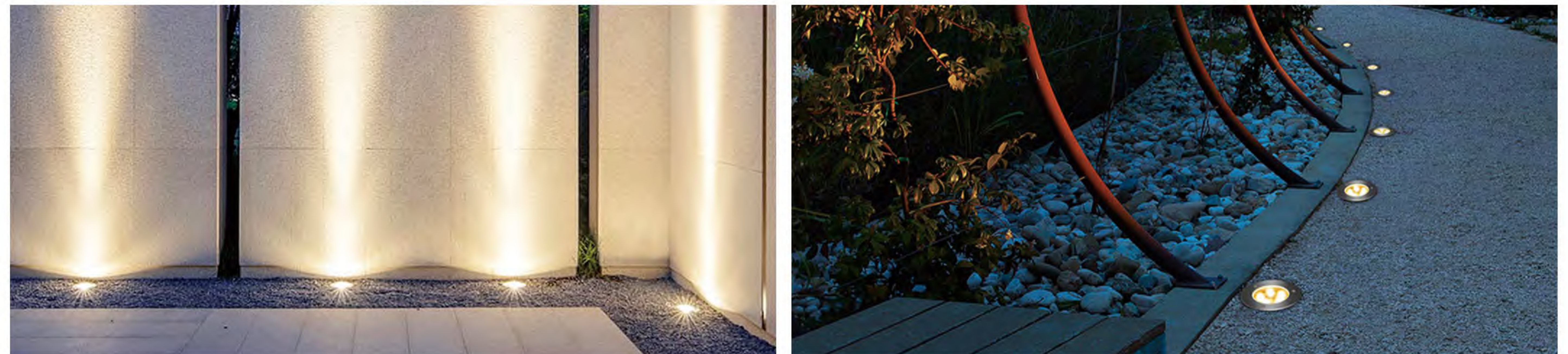

Technical Date (技术参数)

Item No.	Lamp Type	Power	LM	CCT	PF	Voltage	CRI	A	B	C (mm)
MB-D025	LED	5W	350	2700K-6000K	0.6	AC110-265V	80-90	Ø120	90	Ø108



MB LIGHTING
TFB LIGHTING

Guangzhou Huaen Lighting Co.,Ltd

TEL: +86-18665613129

Email: info@china-customization.com

Website: <https://www.tfbcustomlighting.com>