

# MB16-076

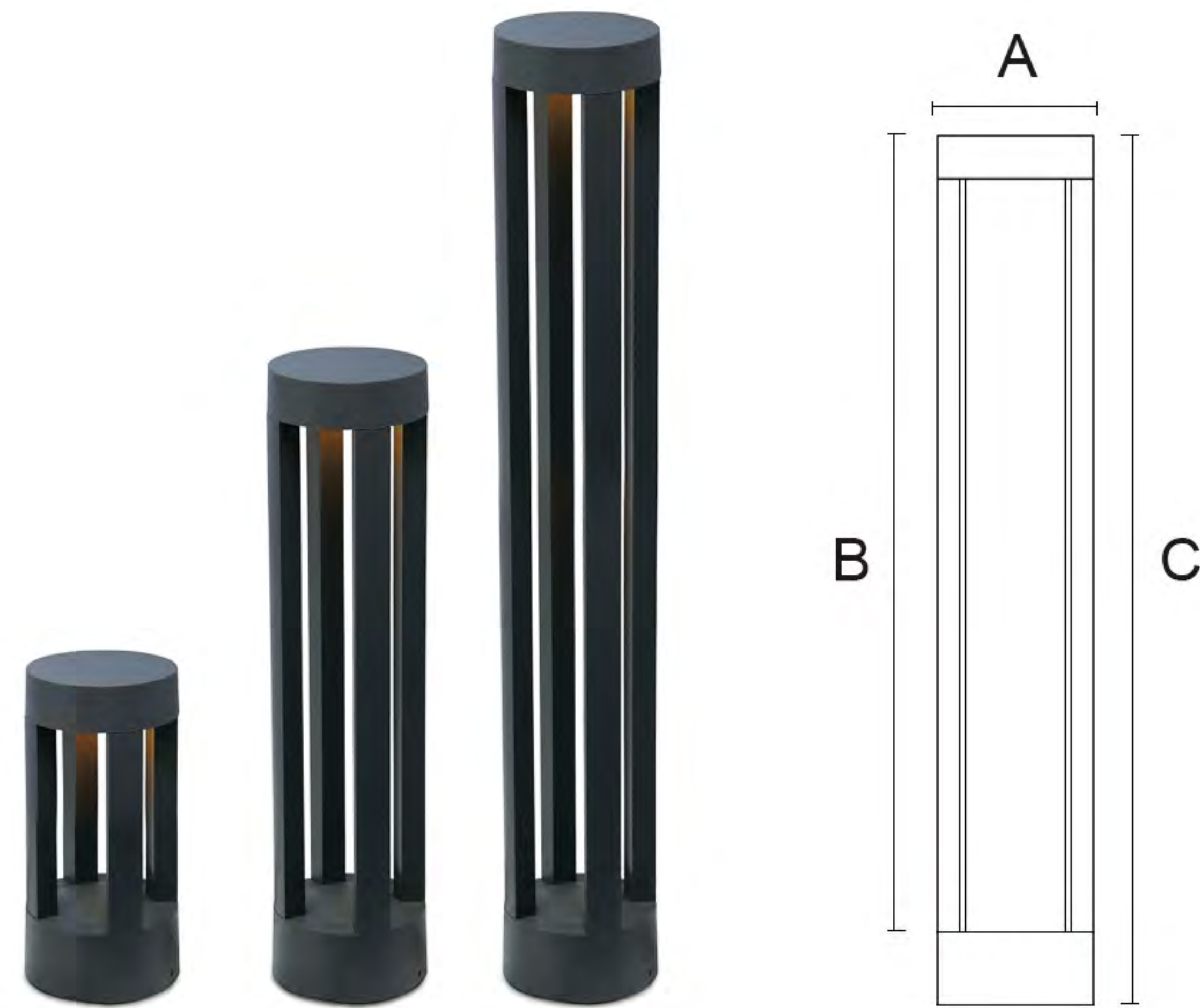

## Features&Benefit (功能和优点)

Category (品类)	Garden Light
Diffuser Material (扩散器材质)	Glass
Cover Material (面盖材质)	Aluminum
Operating mode (运行)	Built in
Steuerbar (开关)	On/Off
IP (防水等级)	54
Mounting type (安装类型)	Put
Mounting location (安装位置)	Overground
Application environment (应用环境)	Indoor/Outdoor
Body color (表面颜色)	Black/Dark Gray/Sliver Gray



## Product Description (产品描述)

Suitable for parks and gardens, neighborhoods, villas, city squares, pedestrian streets, scenic spots or resorts and other various scenes; lawn lamps can be a variety of heights at the same time the lighting effect will be different, more to provide a choice.

## Lightmap (光影图)

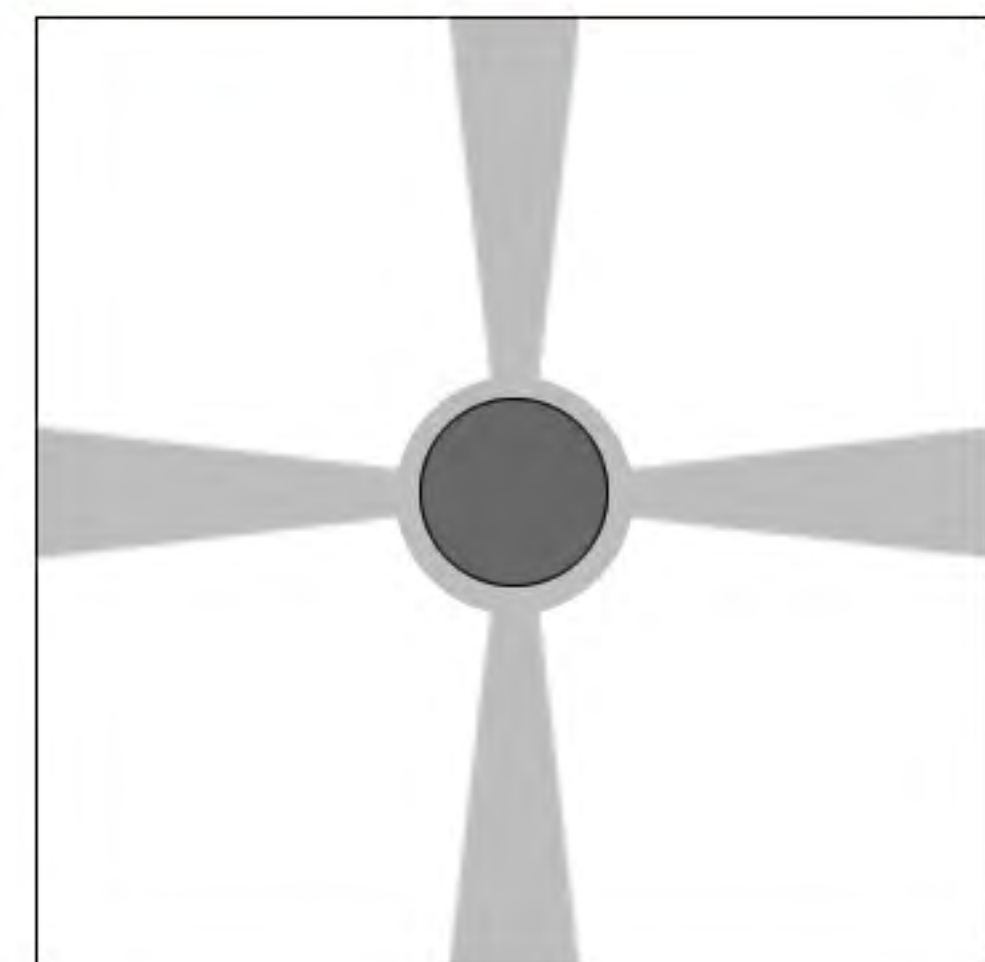

top view (俯视图)

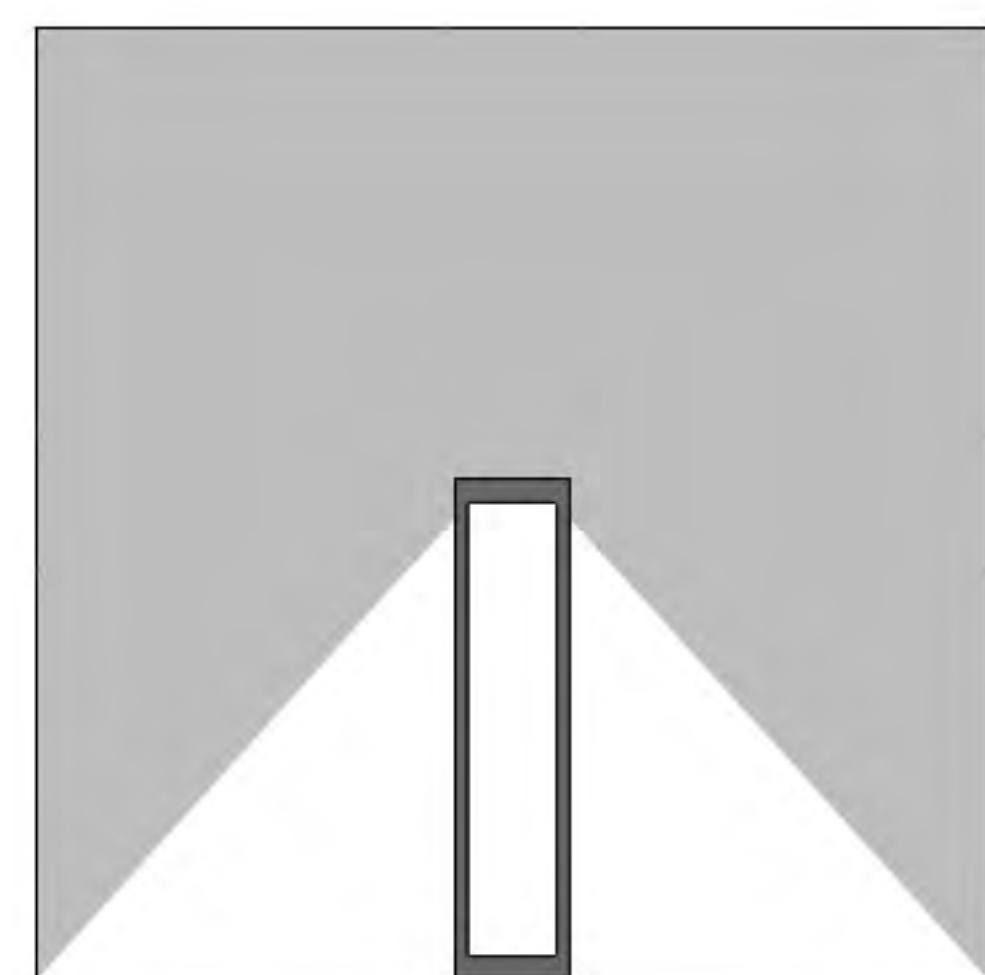

front view (正面图)



## Technical Date (技术参数)

Item No.	Lamp Type	Power	LM	CCT	PF	Voltage	CRI	A	B	C (mm)
MB16-076A	LED	10W	700	2700K-6000K	0.6	AC110-265V	80-90	Ø108	250	300
MB16-076B	LED	10W	700	2700K-6000K	0.6	AC110-265V	80-90	Ø108	550	600
MB16-076C	LED	10W	700	2700K-6000K	0.6	AC110-265V	80-90	Ø108	850	900



# MB16-077

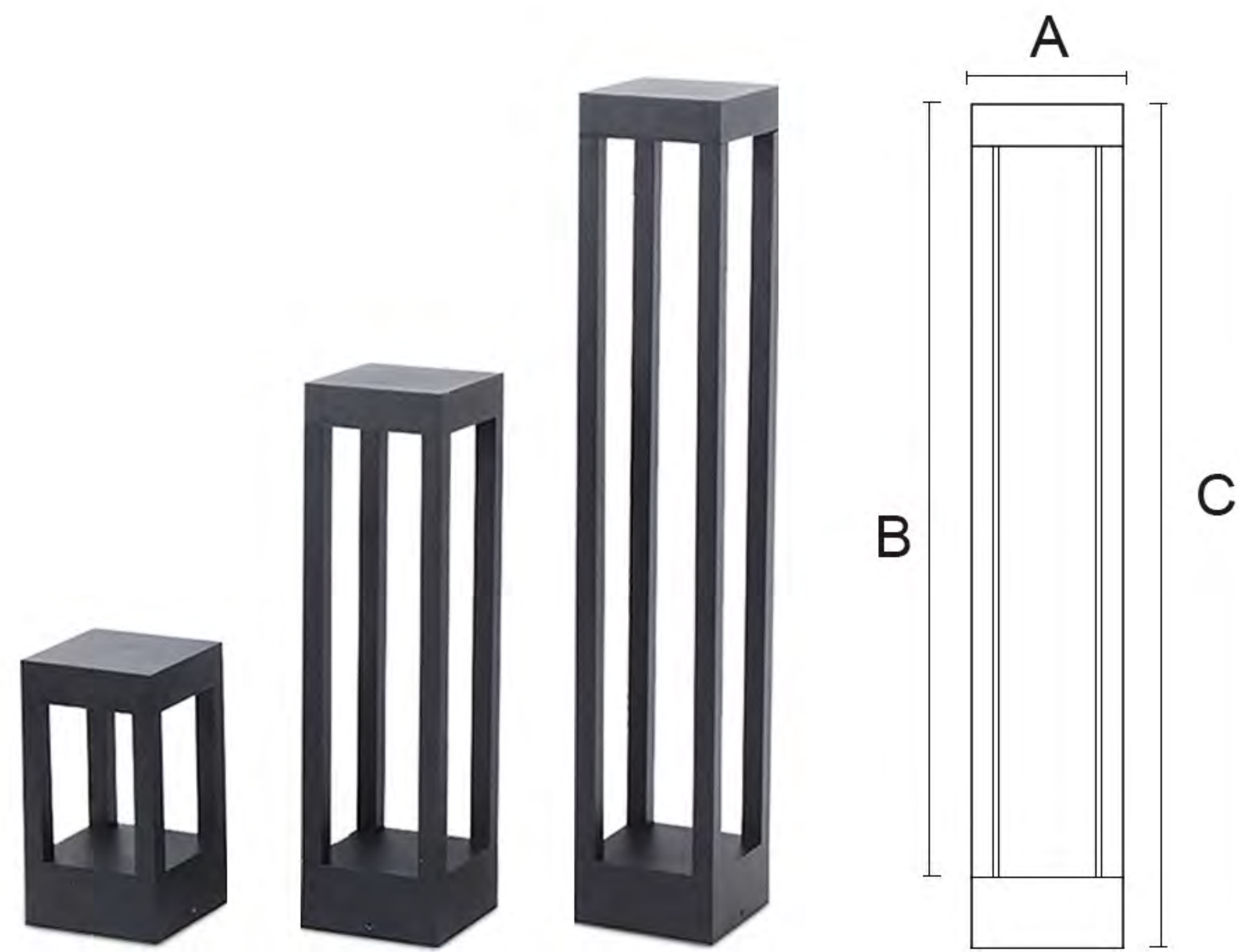

## Features&Benefit (功能和优点)

Category (品类)	Garden Light
Diffuser Material (扩散器材质)	Glass
Cover Material (面盖材质)	Aluminum
Operating mode (运行)	Built in
Steuerbar (开关)	On/Off
IP (防水等级)	54
Mounting type (安装类型)	Put
Mounting location (安装位置)	Overground
Application environment (应用环境)	Indoor/Outdoor
Body color (表面颜色)	Black/Dark Gray/Sliver Gray



## Product Description (产品描述)

Suitable for parks and gardens, neighborhoods, villas, city squares, pedestrian streets, scenic spots or resorts and other various scenes; lawn lamps can be a variety of heights at the same time the lighting effect will be different, more to provide a choice.

## Lightmap (光影图)

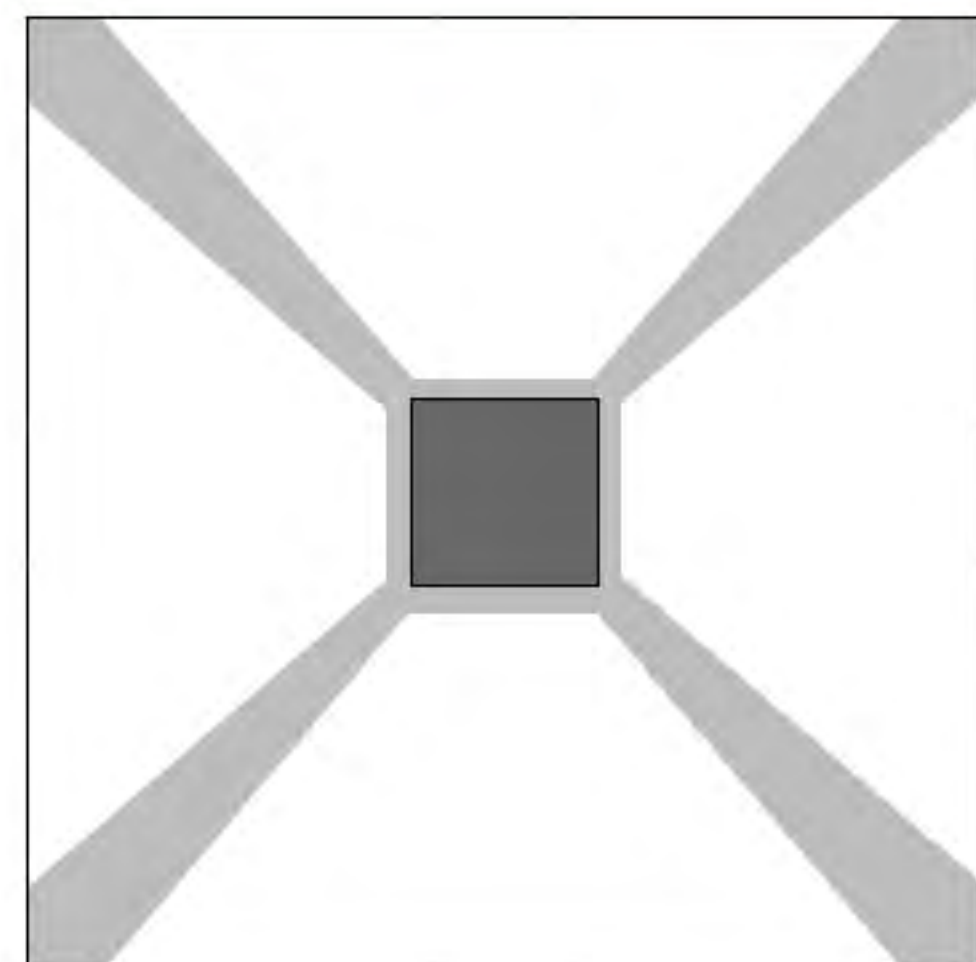

top view (俯视图)

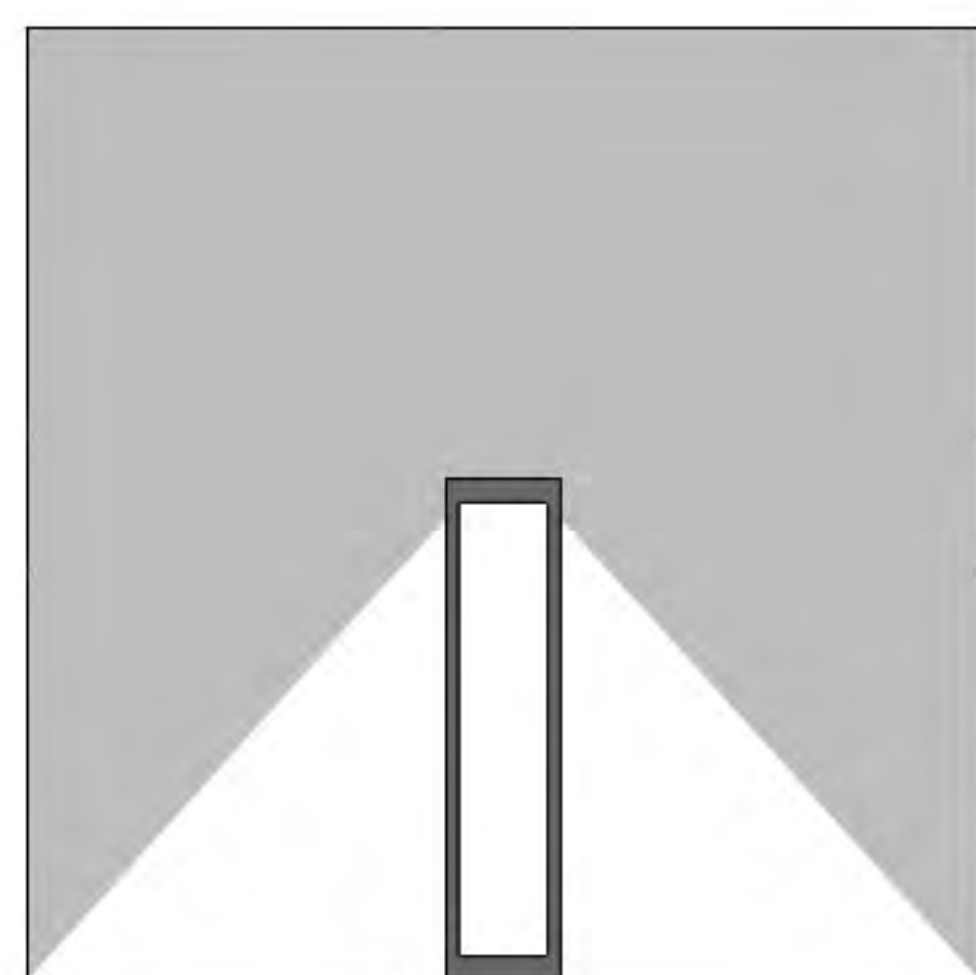

front view (正面图)



## Technical Date (技术参数)

Item No.	Lamp Type	Power	LM	CCT	PF	Voltage	CRI	A	B	C (mm)
MB16-077A	LED	10W	700	2700K-6000K	0.6	AC110-265V	80-90	110	250	300
MB16-077B	LED	10W	700	2700K-6000K	0.6	AC110-265V	80-90	110	550	600
MB16-077C	LED	10W	700	2700K-6000K	0.6	AC110-265V	80-90	110	850	900



# MB16-080

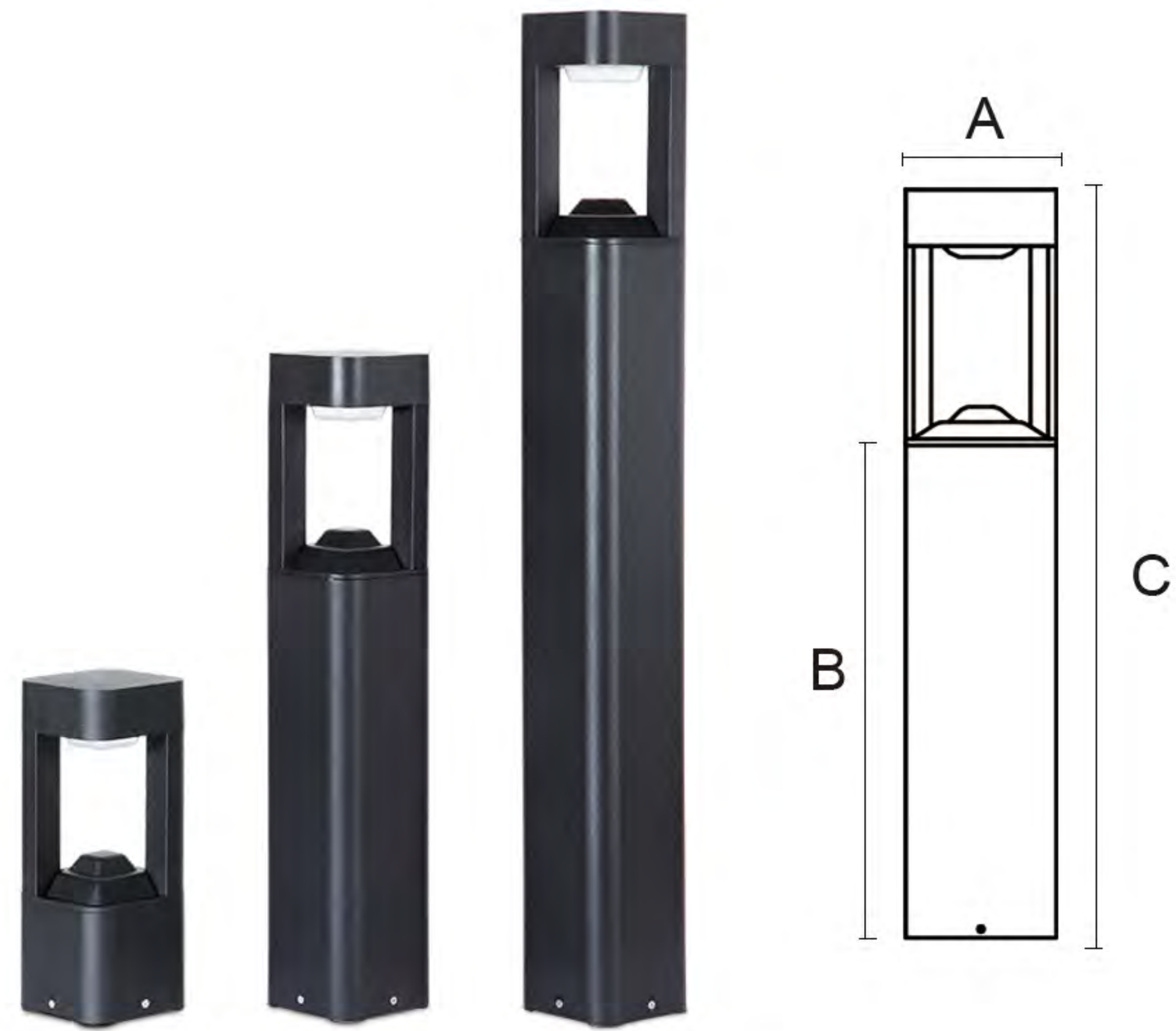

## Features&Benefit (功能和优点)

Category (品类)	Garden Light
Diffuser Material (扩散器材质)	PC
Cover Material (面盖材质)	Aluminum
Operating mode (运行)	Built in
Steuerbar (开关)	On/Off
IP (防水等级)	54
Mounting type (安装类型)	Put
Mounting location (安装位置)	Overground
Application environment (应用环境)	Indoor/Outdoor
Body color (表面颜色)	Black/Dark Gray/Sliver Gray



## Product Description (产品描述)

Suitable for parks and gardens, neighborhoods, villas, city squares, pedestrian streets, scenic spots or resorts and other various scenes; lawn lamps can be a variety of heights at the same time the lighting effect will be different, more to provide a choice.

## Lightmap (光影图)

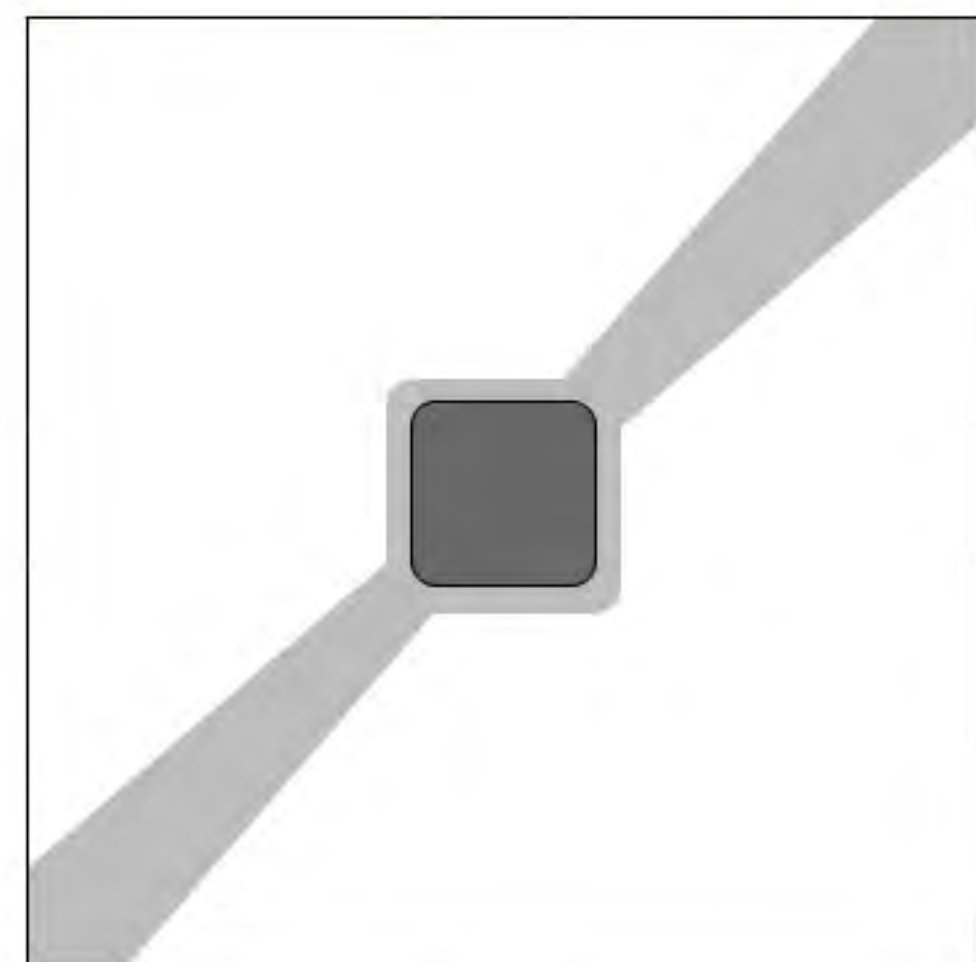

top view (俯视图)

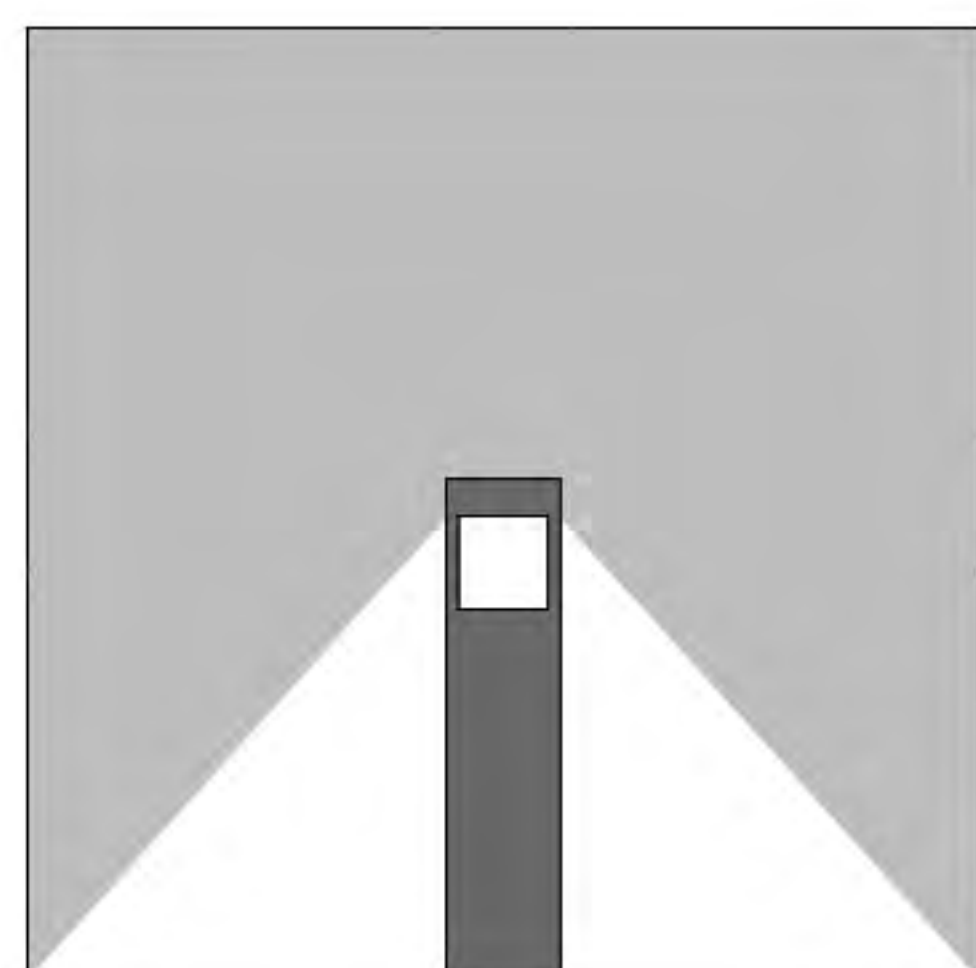

front view (正面图)



## Technical Date (技术参数)

Item No.	Lamp Type	Power	LM	CCT	PF	Voltage	CRI	A	B	C (mm)
MB16-080A	LED	10W	700	2700K-6000K	0.6	AC110-265V	80-90	120	100	300
MB16-080B	LED	10W	700	2700K-6000K	0.6	AC110-265V	80-90	120	400	600
MB16-080C	LED	10W	700	2700K-6000K	0.6	AC110-265V	80-90	120	700	900



# MB16-080-SL

# SOLAR LIGHT

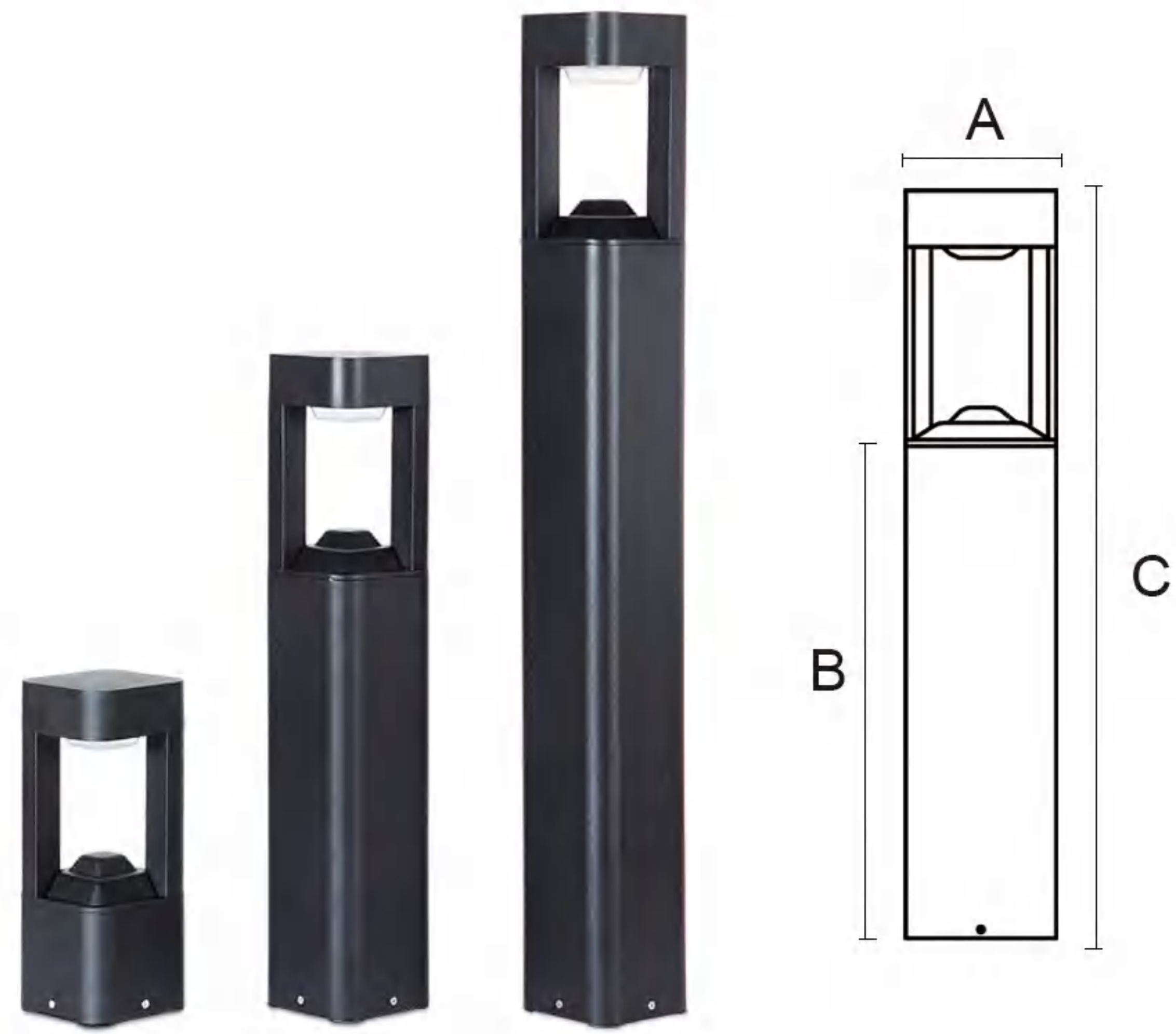

## Features&Benefit (功能和优点)

Category (品类)	Garden Light
Diffuser Material (扩散器材质)	PC
Cover Material (面盖材质)	Aluminum+Solar Panel
Operating mode (运行)	Built in
Steuerbar (开关)	On/Off
Working Hours (工作时长)	8 Hours
IP (防水等级)	54
Mounting type (安装类型)	Put
Mounting location (安装位置)	Overground
Application environment (应用环境)	Indoor/Outdoor
Body color (表面颜色)	Black/Dark Gray/Sliver Gray



## Product Description (产品描述)

Suitable for parks and gardens, neighborhoods, villas, city squares, pedestrian streets, scenic spots or resorts and other various scenes; lawn lamps can be a variety of heights at the same time the lighting effect will be different, more to provide a choice.

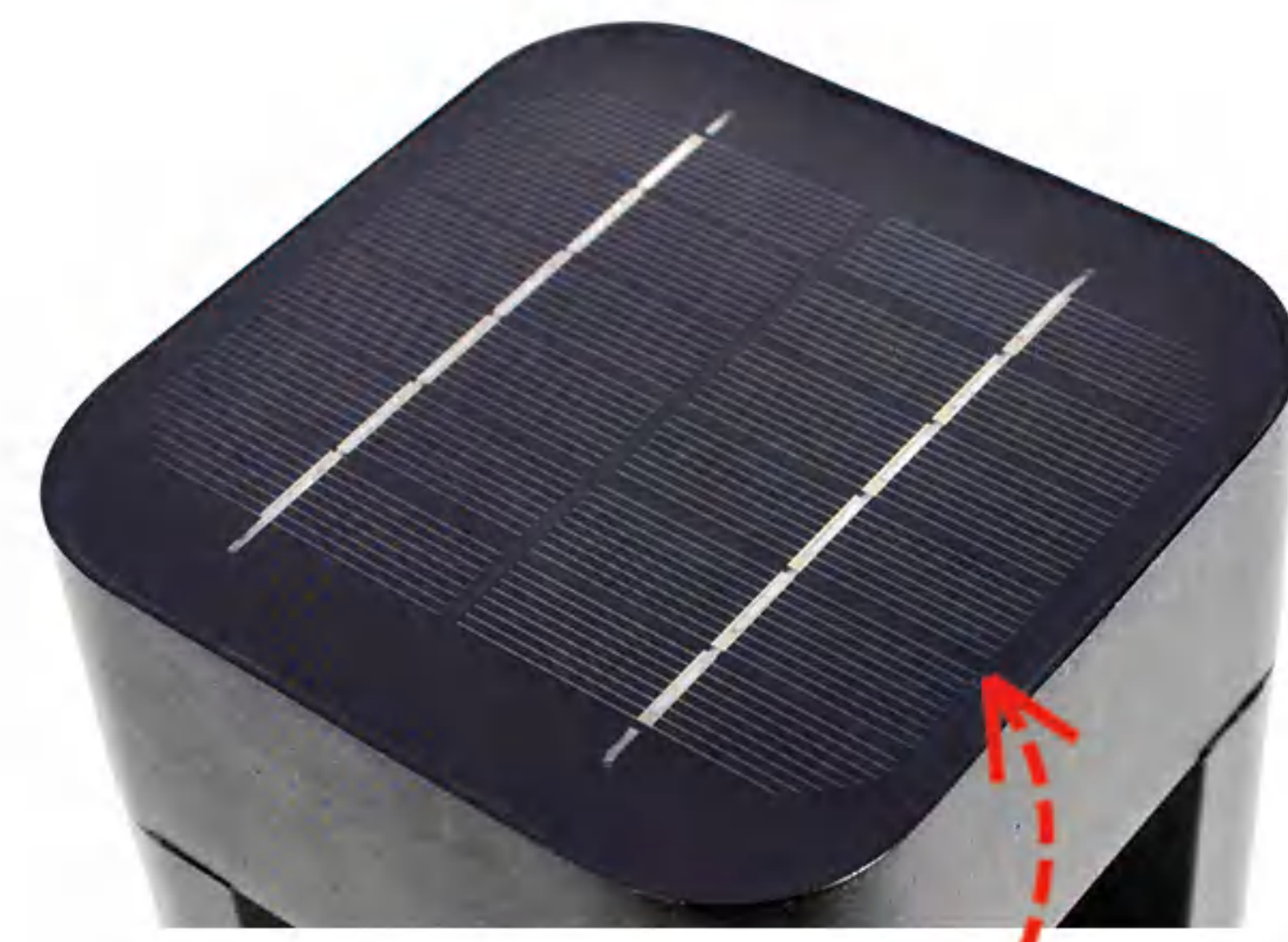

Solar Panel



No/Off



## Technical Date (技术参数)

Item No.	Lamp Type	Power	LM	CCT	CRI	A	B	C (mm)
MB16-080A-SL	LED	3W	210	2700K-6000K	80-90	120	100	300
MB16-080B-SL	LED	3W	210	2700K-6000K	80-90	120	400	600
MB16-080C-SL	LED	3W	210	2700K-6000K	80-90	120	700	900



# MB16-081

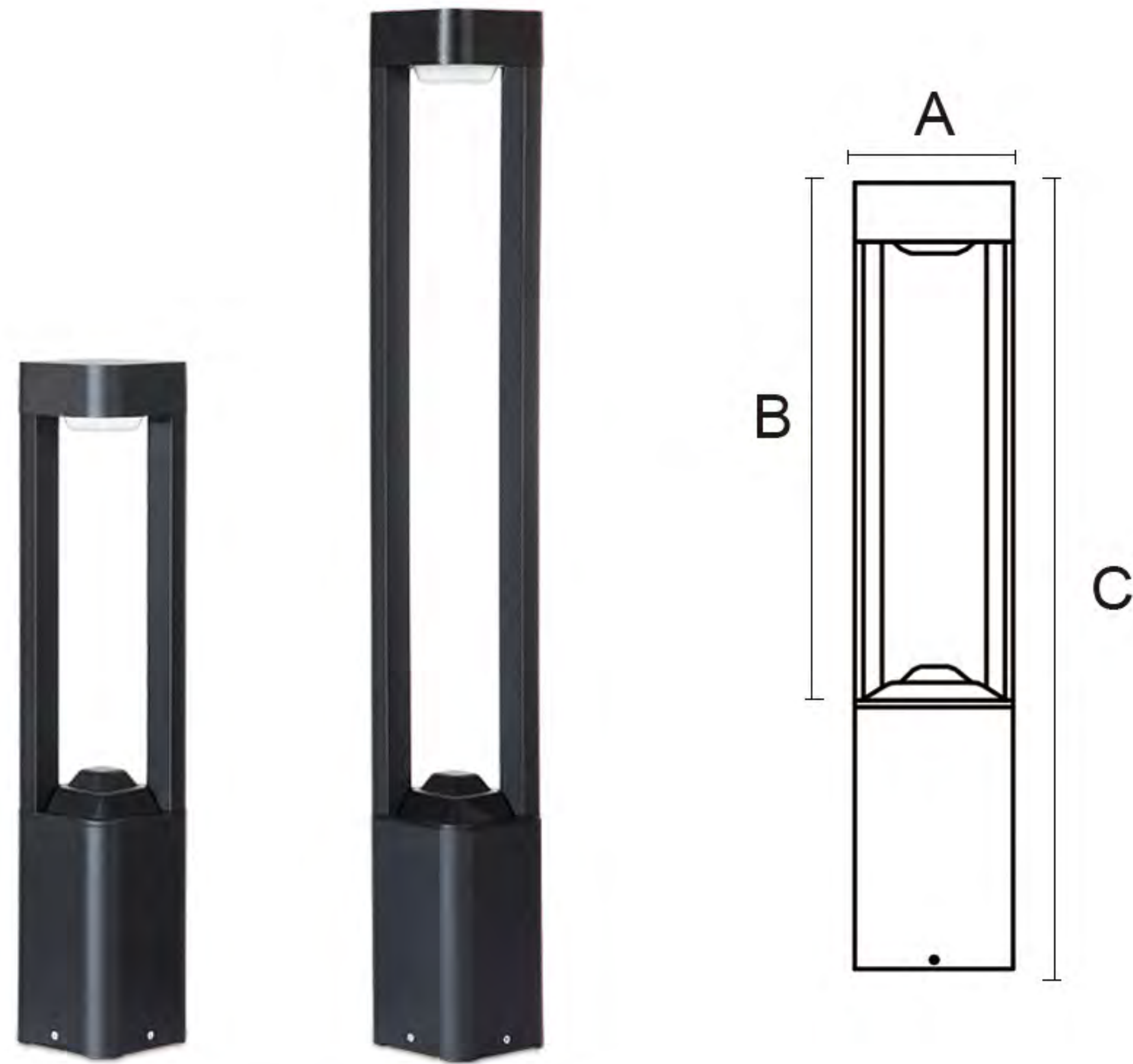

## Features&Benefit (功能和优点)

Category (品类)	Garden Light
Diffuser Material (扩散器材质)	PC
Cover Material (面盖材质)	Aluminum
Operating mode (运行)	Built in
Steuerbar (开关)	On/Off
IP (防水等级)	54
Mounting type (安装类型)	Put
Mounting location (安装位置)	Overground
Application environment (应用环境)	Indoor/Outdoor
Body color (表面颜色)	Black/Dark Gray/Sliver Gray



## Product Description (产品描述)

Suitable for parks and gardens, neighborhoods, villas, city squares, pedestrian streets, scenic spots or resorts and other various scenes; lawn lamps can be a variety of heights at the same time the lighting effect will be different, more to provide a choice.

## Lightmap (光影图)

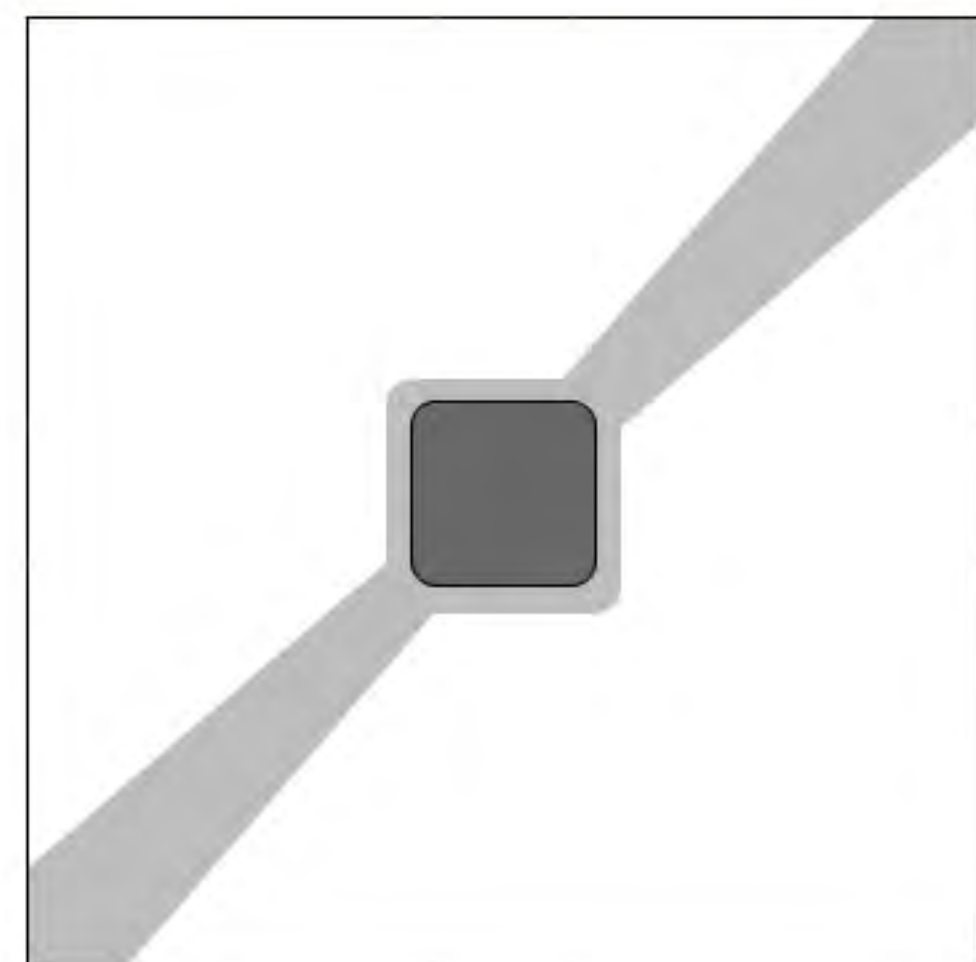

top view (俯视图)

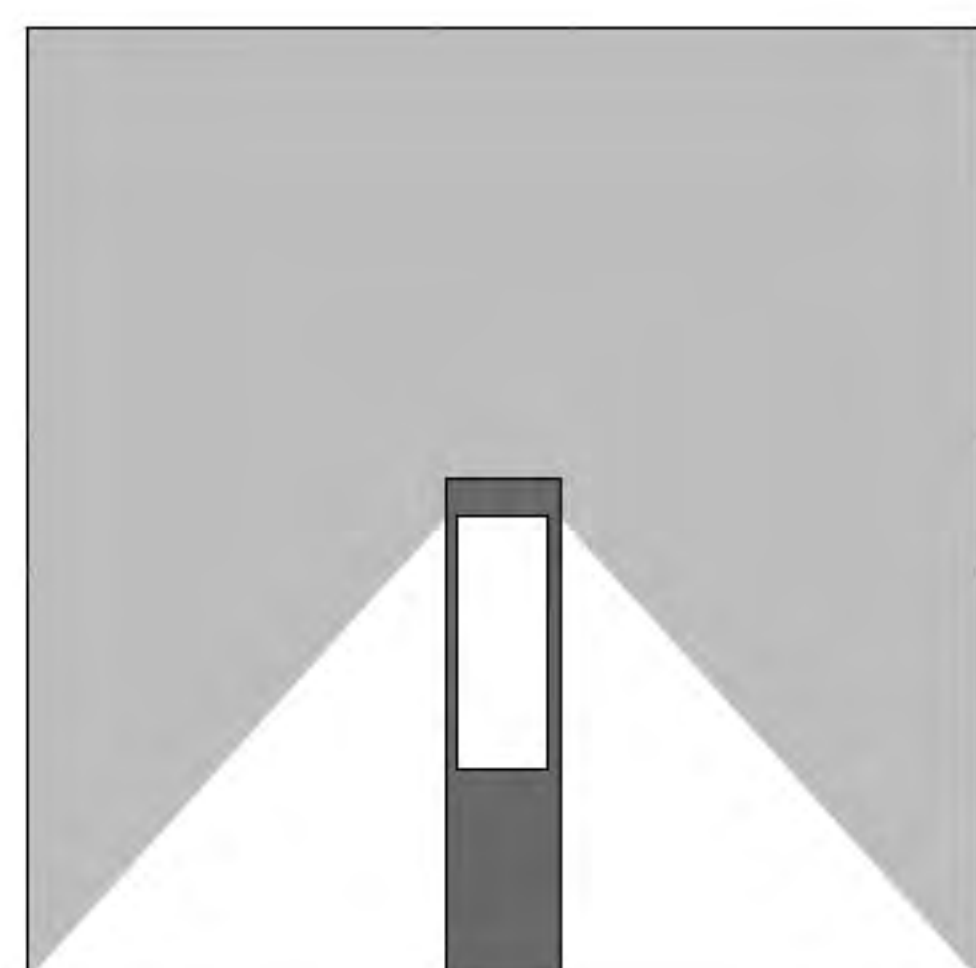

front view (正面图)



## Technical Date (技术参数)

Item No.	Lamp Type	Power	LM	CCT	PF	Voltage	CRI	A	B	C (mm)
MB16-081A	LED	10W	700	2700K-6000K	0.6	AC110-265V	80-90	120	400	600
MB16-081B	LED	10W	700	2700K-6000K	0.6	AC110-265V	80-90	120	700	900



# MB16-081-SL

# SOLAR LIGHT

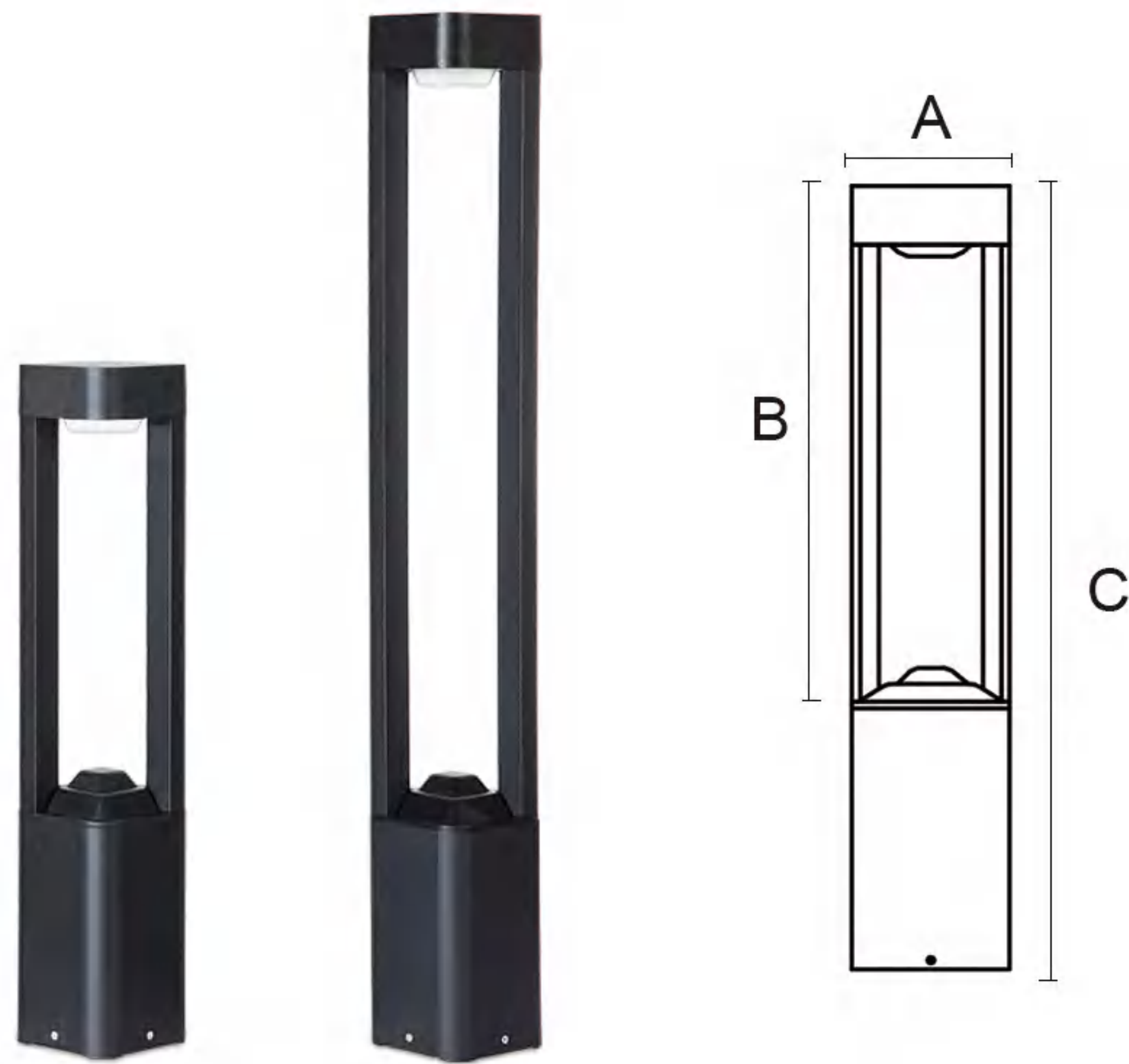

## Features&Benefit (功能和优点)

Category (品类)	Garden Light
Diffuser Material (扩散器材质)	PC
Cover Material (面盖材质)	Aluminum+Solar Panel
Operating mode (运行)	Built in
Steuerbar (开关)	On/Off
Working Hours (工作时长)	8 Hours
IP (防水等级)	54
Mounting type (安装类型)	Put
Mounting location (安装位置)	Overground
Application environment (应用环境)	Indoor/Outdoor
Body color (表面颜色)	Black/Dark Gray/Sliver Gray



## Product Description (产品描述)

Suitable for parks and gardens, neighborhoods, villas, city squares, pedestrian streets, scenic spots or resorts and other various scenes; lawn lamps can be a variety of heights at the same time the lighting effect will be different, more to provide a choice.

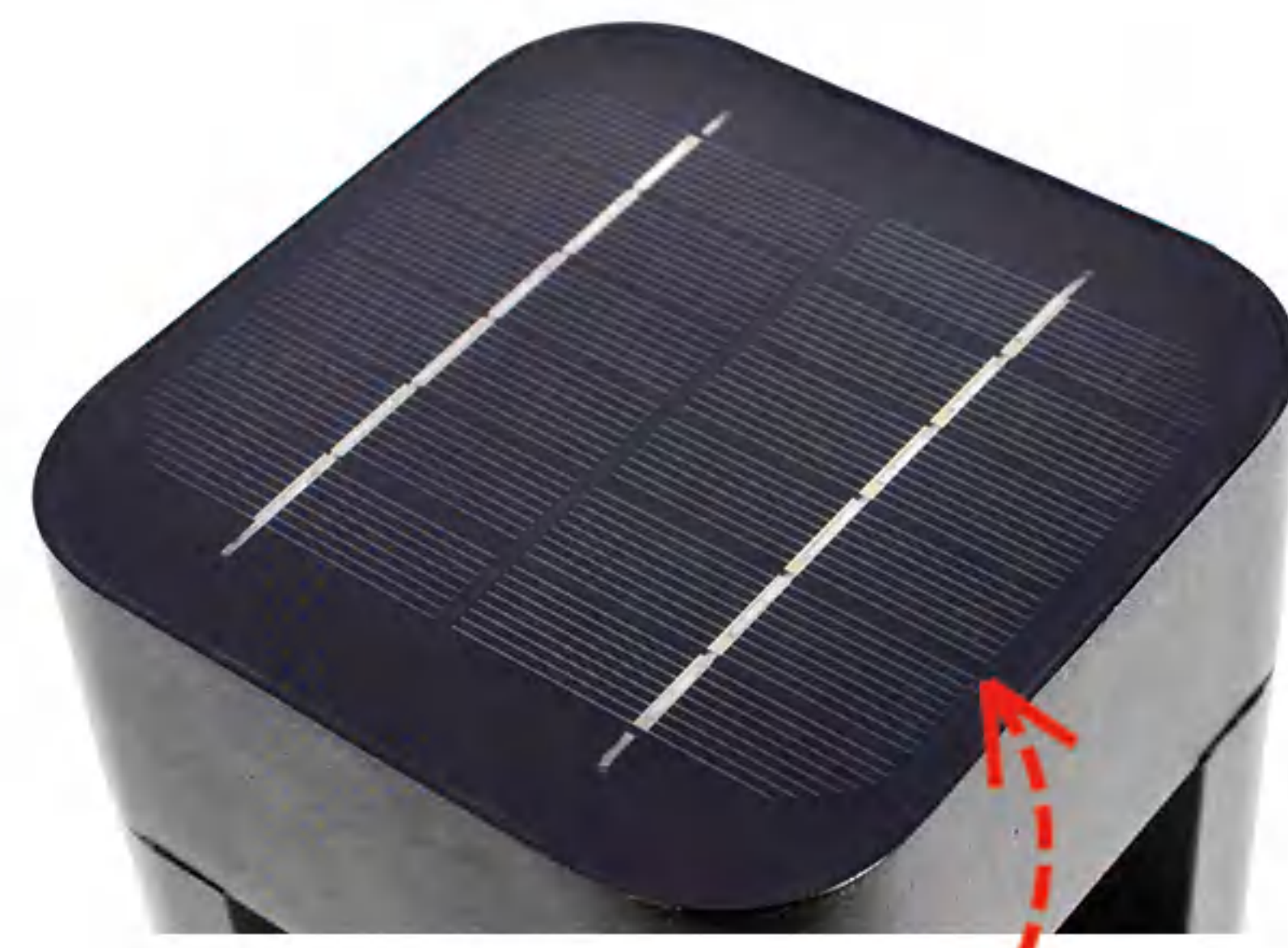

Solar Panel



No/Off



## Technical Date (技术参数)

Item No.	Lamp Type	Power	LM	CCT	CRI	A	B	C (mm)
MB16-081A-SL	LED	3W	210	2700K-6000K	80-90	120	400	600
MB16-081B-SL	LED	3W	210	2700K-6000K	80-90	120	700	900



# MB16-082

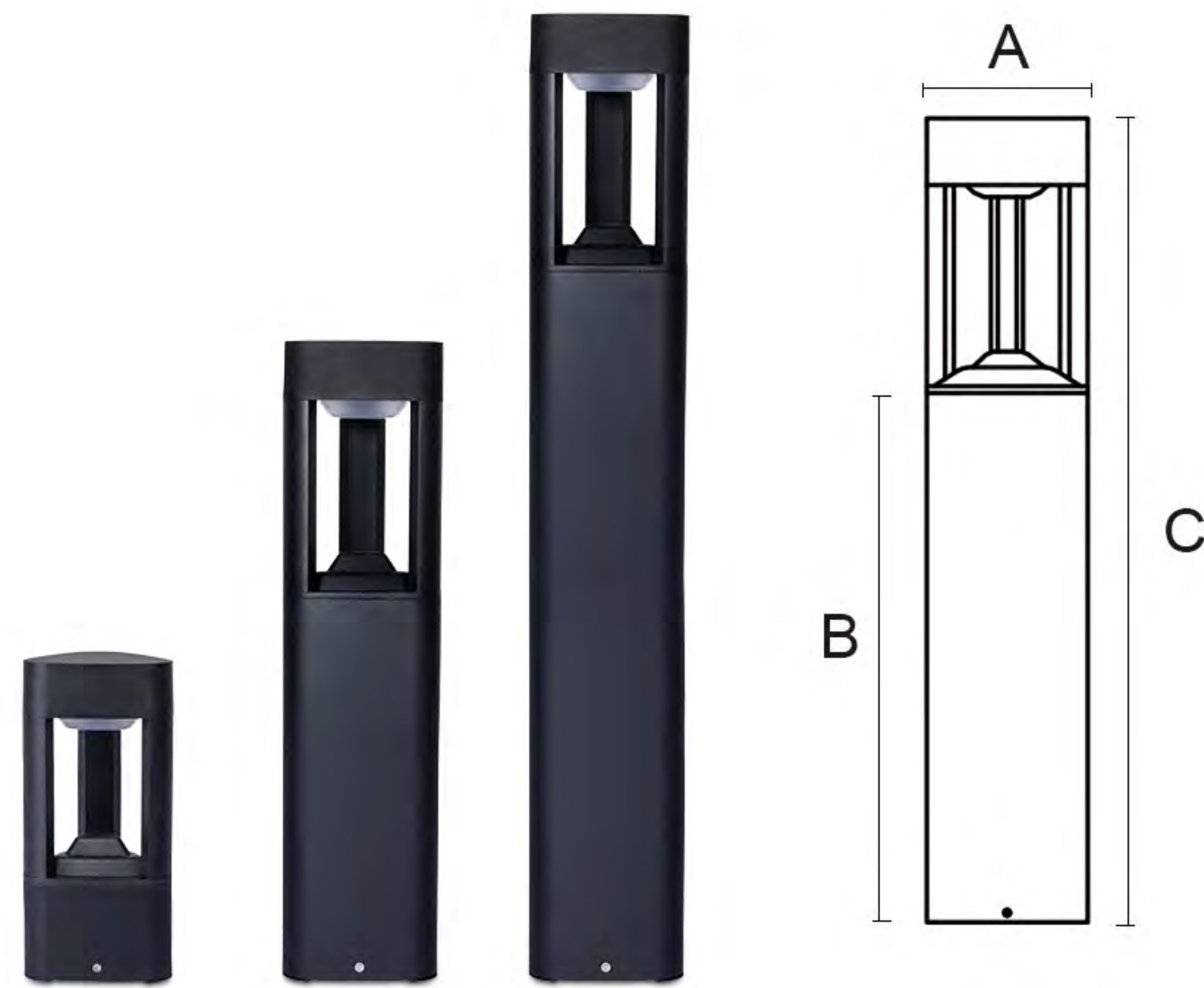

## Features&Benefit (功能和优点)

Category (品类)	Garden Light
Diffuser Material (扩散器材质)	PC
Cover Material (面盖材质)	Aluminum
Operating mode (运行)	Built in
Steuerbar (开关)	On/Off
IP (防水等级)	54
Mounting type (安装类型)	Put
Mounting location (安装位置)	Overground
Application environment (应用环境)	Indoor/Outdoor
Body color (表面颜色)	Black/Dark Gray/Sliver Gray



## Product Description (产品描述)

Suitable for parks and gardens, neighborhoods, villas, city squares, pedestrian streets, scenic spots or resorts and other various scenes; lawn lamps can be a variety of heights at the same time the lighting effect will be different, more to provide a choice.

## Lightmap (光影图)

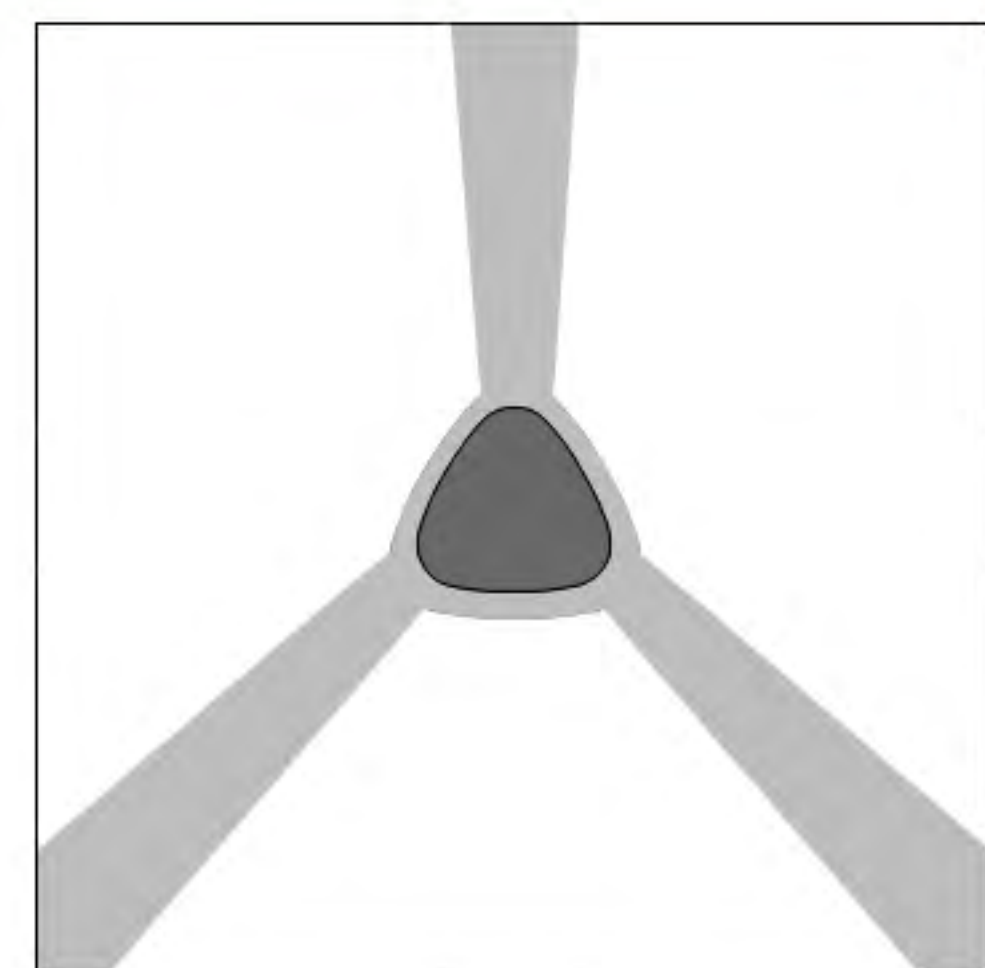

top view (俯视图)

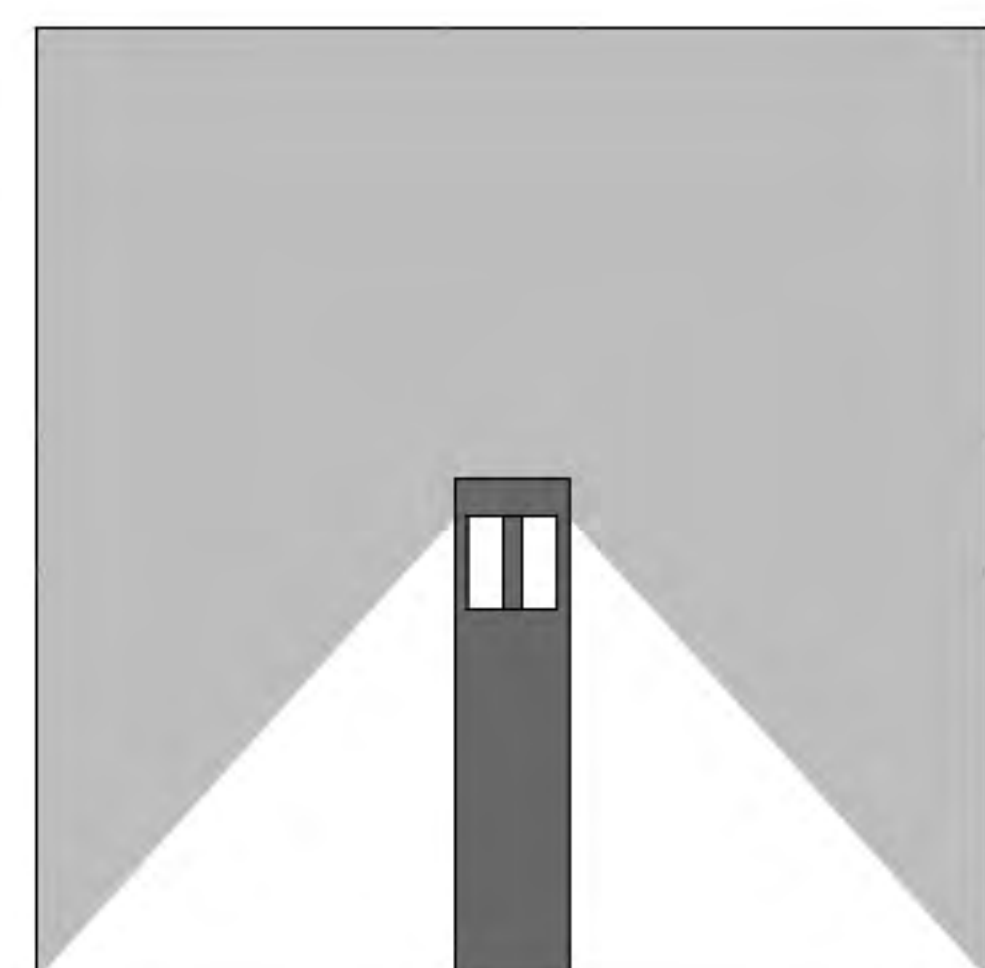

front view (正面图)



## Technical Date (技术参数)

Item No.	Lamp Type	Power	LM	CCT	PF	Voltage	CRI	A	B	C (mm)
MB16-082A	LED	10W	700	2700K-6000K	0.6	AC110-265V	80-90	120	100	300
MB16-082B	LED	10W	700	2700K-6000K	0.6	AC110-265V	80-90	120	400	600
MB16-082C	LED	10W	700	2700K-6000K	0.6	AC110-265V	80-90	120	700	900



# MB16-083

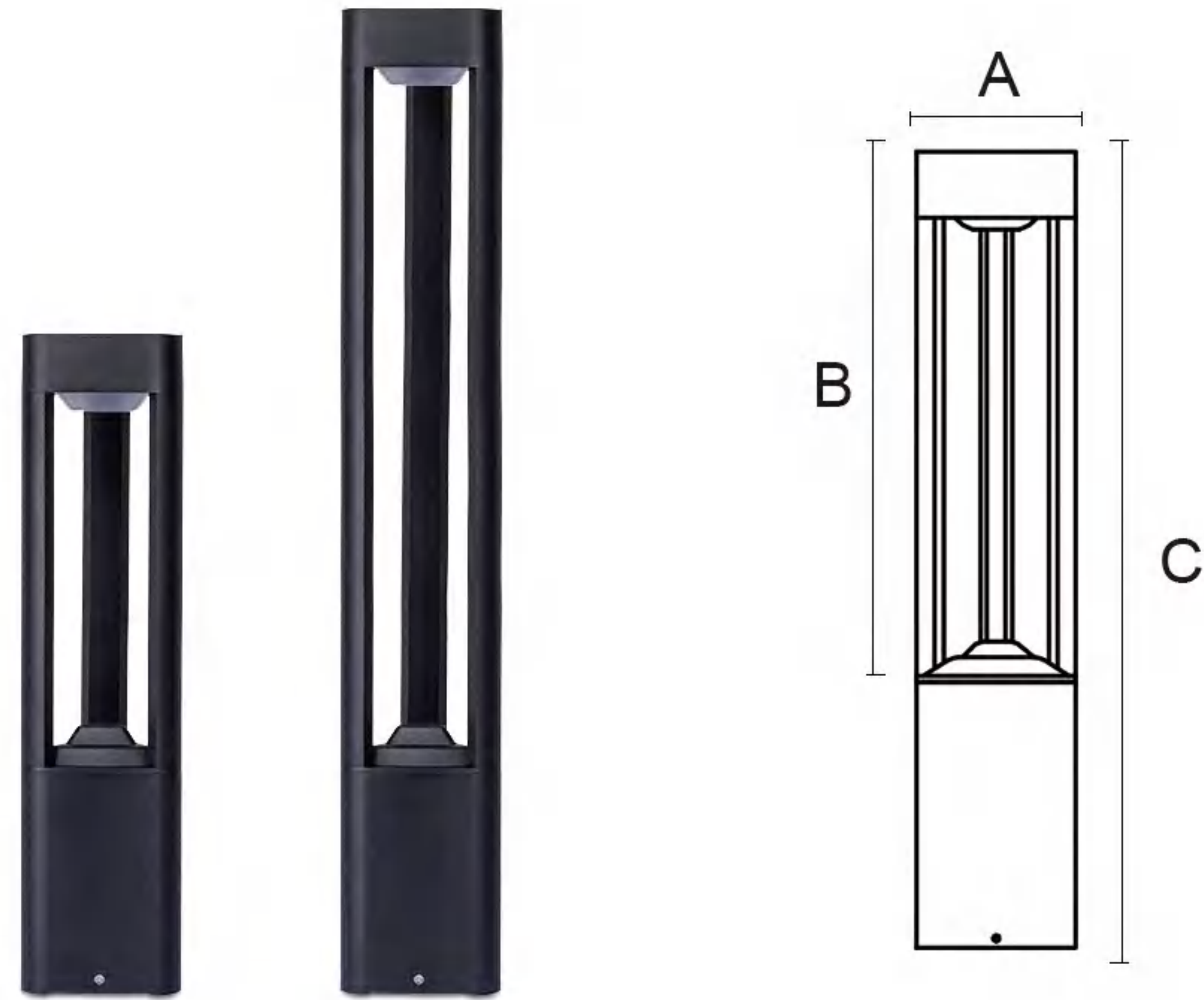

## Features&Benefit (功能和优点)

Category (品类)	Garden Light
Diffuser Material (扩散器材质)	PC
Cover Material (面盖材质)	Aluminum
Operating mode (运行)	Built in
Steuerbar (开关)	On/Off
IP (防水等级)	54
Mounting type (安装类型)	Put
Mounting location (安装位置)	Overground
Application environment (应用环境)	Indoor/Outdoor
Body color (表面颜色)	Black/Dark Gray/Sliver Gray



## Product Description (产品描述)

Suitable for parks and gardens, neighborhoods, villas, city squares, pedestrian streets, scenic spots or resorts and other various scenes; lawn lamps can be a variety of heights at the same time the lighting effect will be different, more to provide a choice.

## Lightmap (光影图)

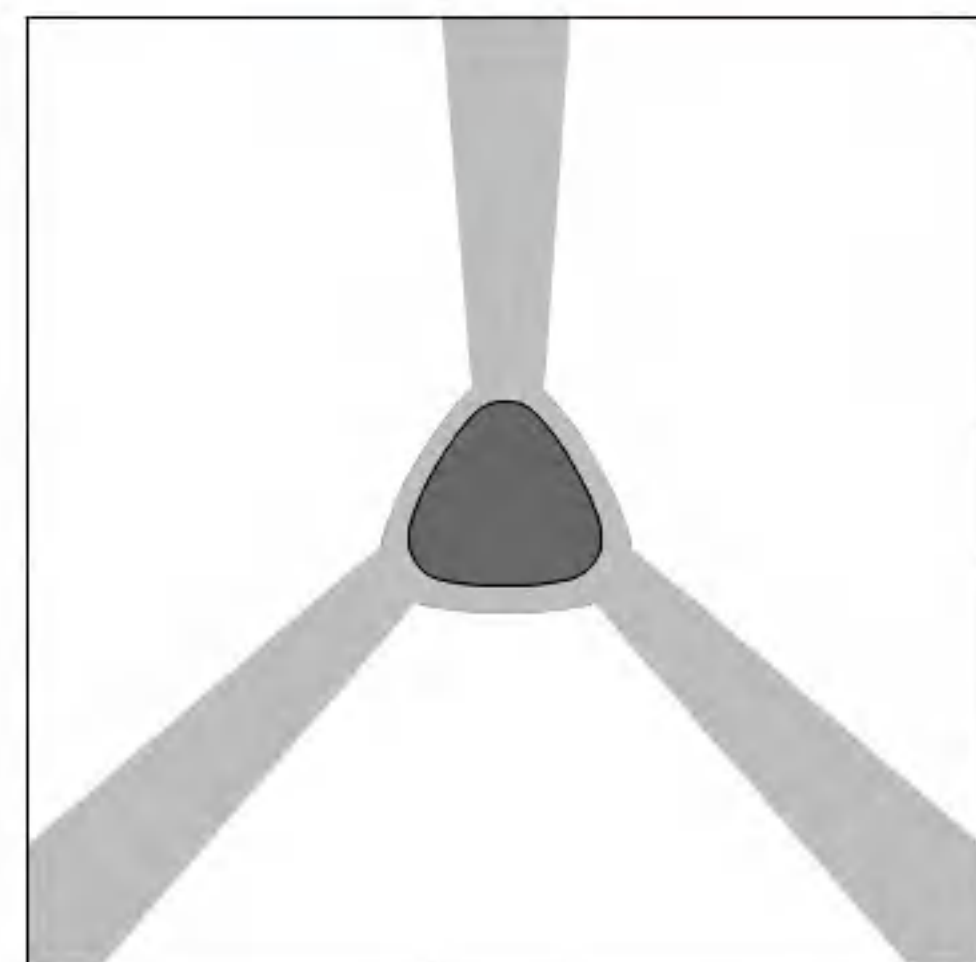

top view (俯视图)

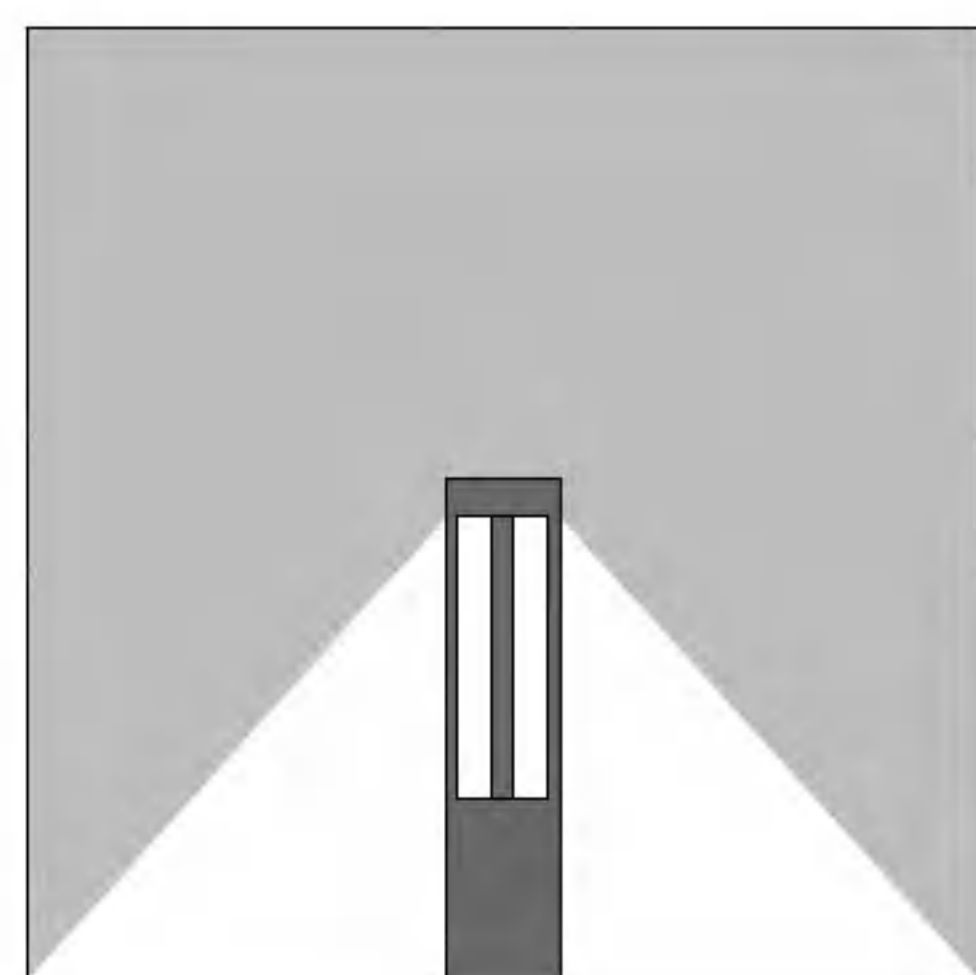

front view (正面图)



## Technical Date (技术参数)

Item No.	Lamp Type	Power	LM	CCT	PF	Voltage	CRI	A	B	C (mm)
MB16-083A	LED	10W	700	2700K-6000K	0.6	AC110-265V	80-90	120	400	600
MB16-083B	LED	10W	700	2700K-6000K	0.6	AC110-265V	80-90	120	700	900



# MB18-C001

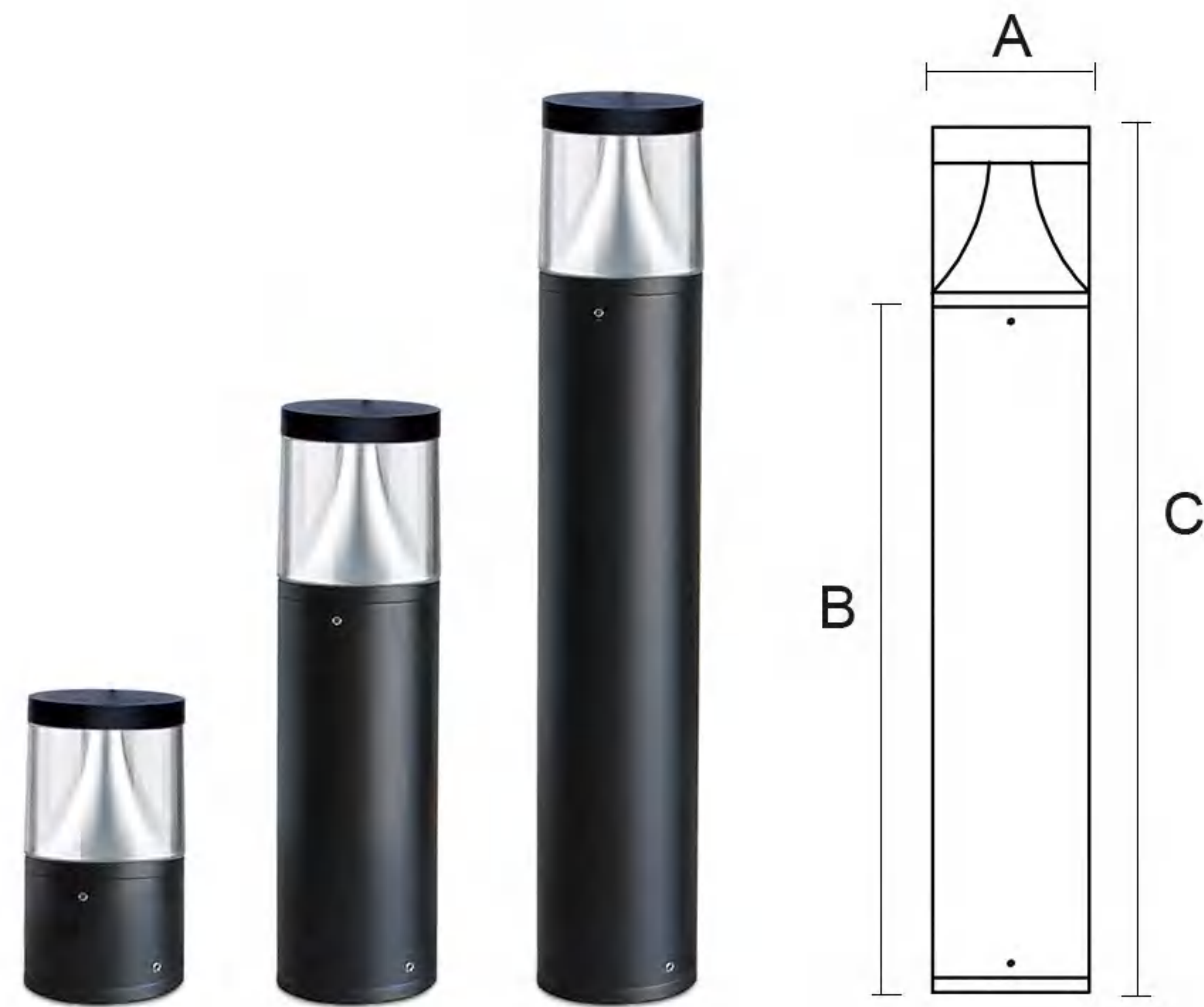

## Features&Benefit (功能和优点)

Category (品类)	Garden Light
Diffuser Material (扩散器材质)	PC
Cover Material (面盖材质)	Aluminum
Operating mode (运行)	Built in
Steuerbar (开关)	On/Off
IP (防水等级)	54
Mounting type (安装类型)	Put
Mounting location (安装位置)	Overground
Application environment (应用环境)	Indoor/Outdoor
Body color (表面颜色)	Black/Dark Gray/Sliver Gray



## Product Description (产品描述)

Suitable for parks and gardens, neighborhoods, villas, city squares, pedestrian streets, scenic spots or resorts and other various scenes; lawn lamps can be a variety of heights at the same time the lighting effect will be different, more to provide a choice.

## Lightmap (光影图)

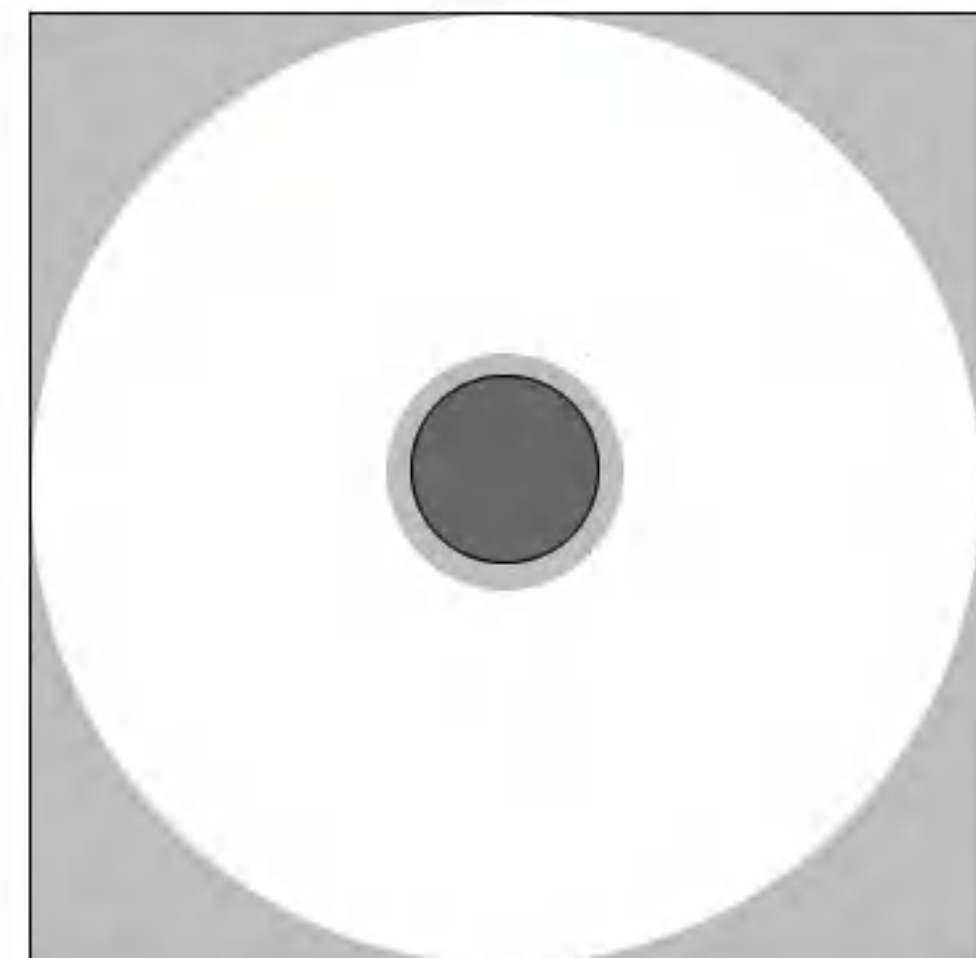

top view (俯视图)

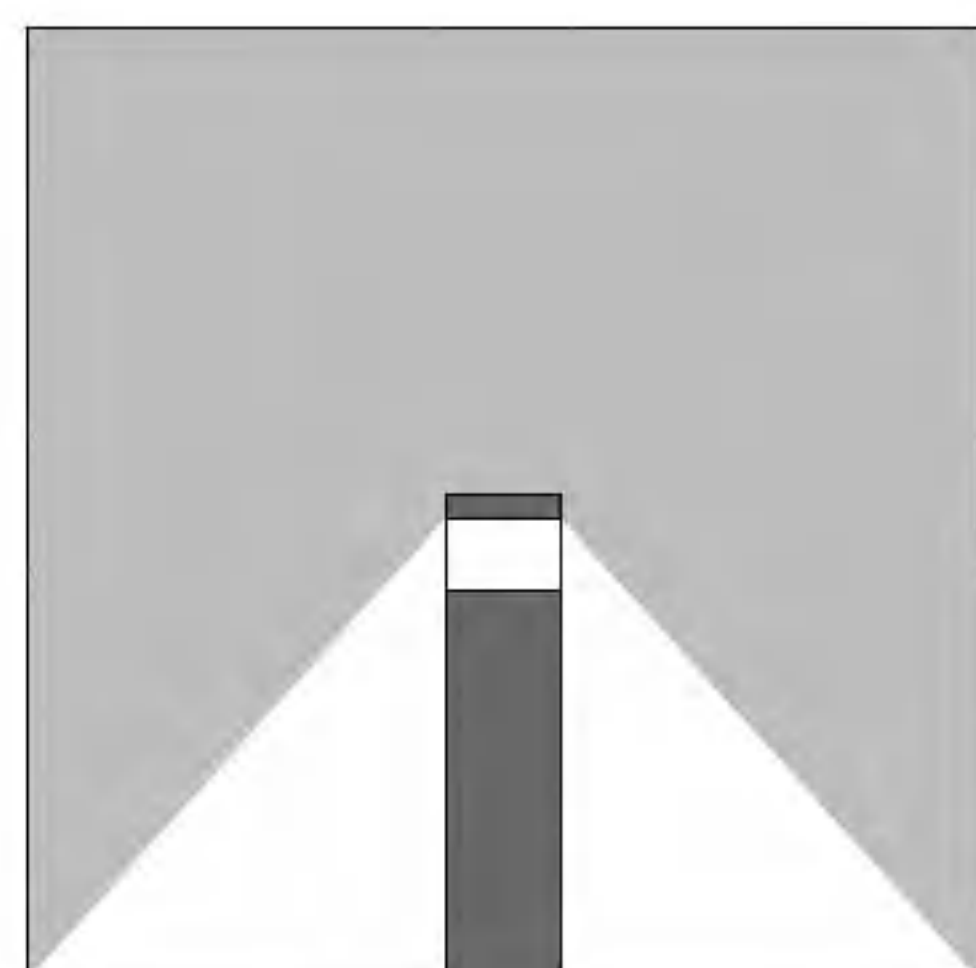

front view (正面图)

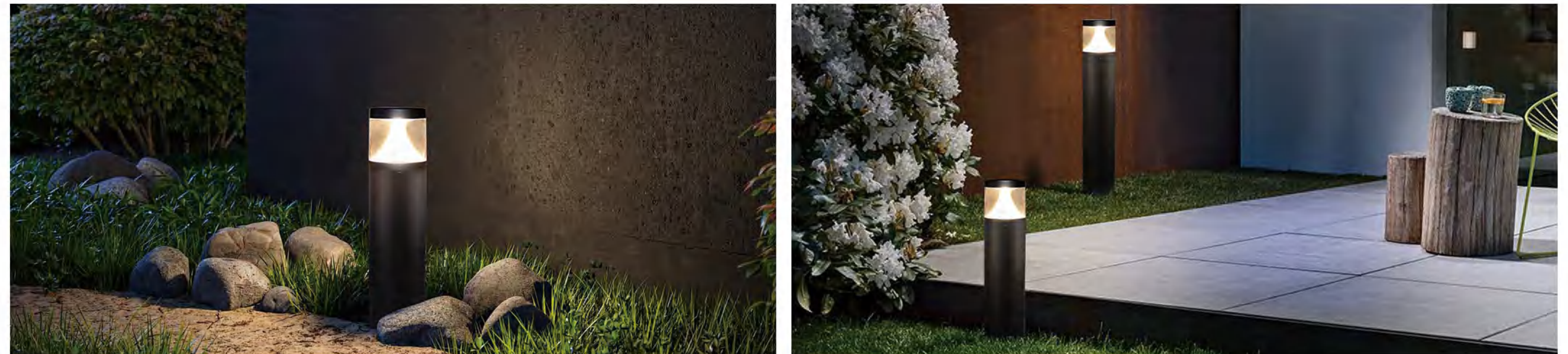

## Technical Date (技术参数)

Item No.	Lamp Type	Power	LM	CCT	PF	Voltage	CRI	A	B	C (mm)
MB18-C001A-300	LED	6W	420	2700K-6000K	0.6	AC110-265V	80-90	Ø90	180	300
MB18-C001A-600	LED	6W	420	2700K-6000K	0.6	AC110-265V	80-90	Ø90	480	600
MB18-C001A-900	LED	6W	420	2700K-6000K	0.6	AC110-265V	80-90	Ø90	780	900
MB18-C001B-300	LED	9W	630	2700K-6000K	0.6	AC110-265V	80-90	Ø108	175	300
MB18-C001B-600	LED	9W	630	2700K-6000K	0.6	AC110-265V	80-90	Ø108	475	600
MB18-C001B-900	LED	9W	630	2700K-6000K	0.6	AC110-265V	80-90	Ø108	775	900
MB18-C001C-300	LED	12W	840	2700K-6000K	0.6	AC110-265V	80-90	Ø150	155	300
MB18-C001C-600	LED	12W	840	2700K-6000K	0.6	AC110-265V	80-90	Ø150	455	600
MB18-C001C-900	LED	12W	840	2700K-6000K	0.6	AC110-265V	80-90	Ø150	755	900



# MB18-C002

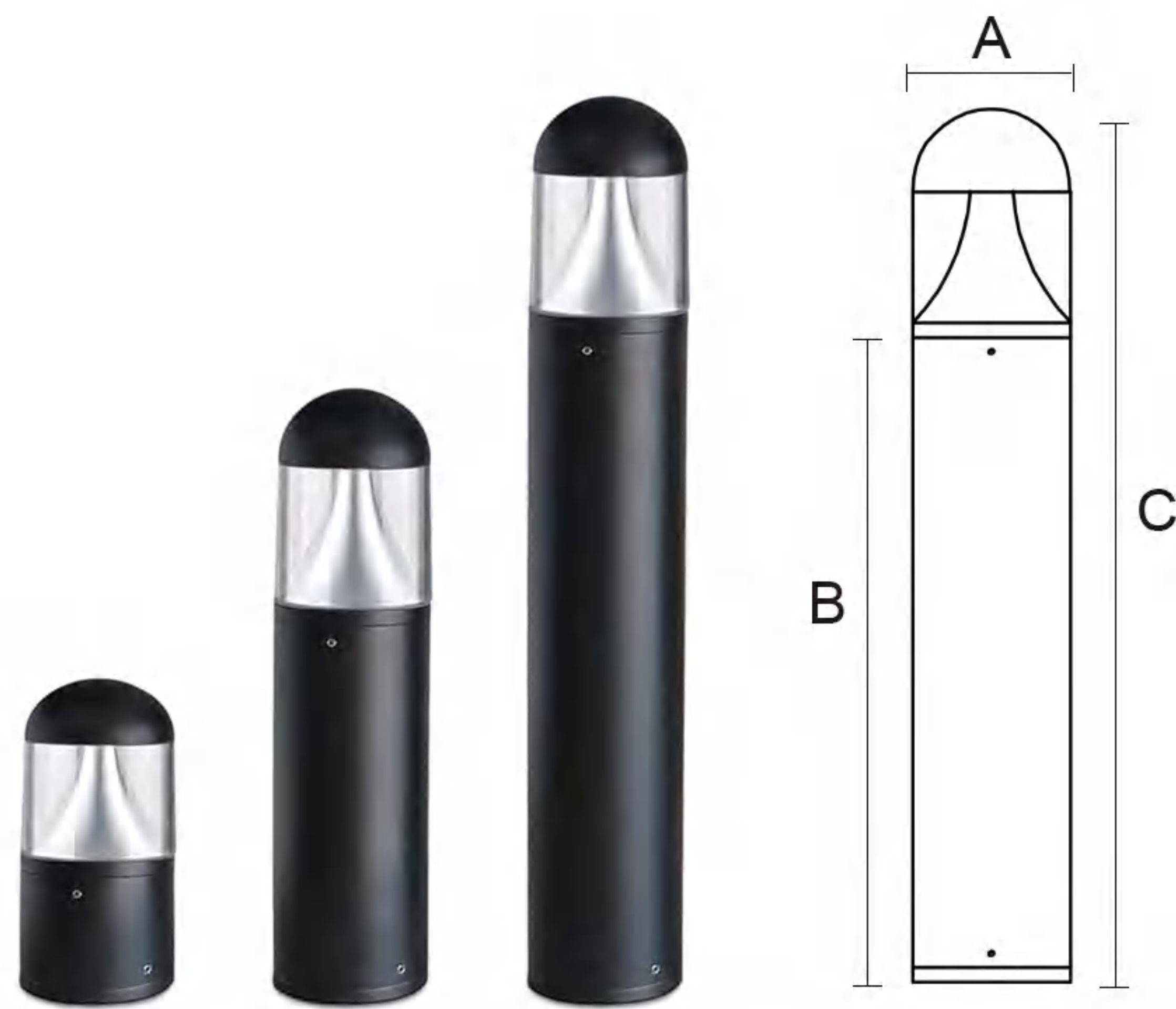

## Features&Benefit (功能和优点)

Category (品类)	Garden Light
Diffuser Material (扩散器材质)	PC
Cover Material (面盖材质)	Aluminum
Operating mode (运行)	Built in
Steuerbar (开关)	On/Off
IP (防水等级)	54
Mounting type (安装类型)	Put
Mounting location (安装位置)	Overground
Application environment (应用环境)	Indoor/Outdoor
Body color (表面颜色)	Black/Dark Gray/Sliver Gray



## Product Description (产品描述)

Suitable for parks and gardens, neighborhoods, villas, city squares, pedestrian streets, scenic spots or resorts and other various scenes; lawn lamps can be a variety of heights at the same time the lighting effect will be different, more to provide a choice.

## Lightmap (光影图)



top view (俯视图)

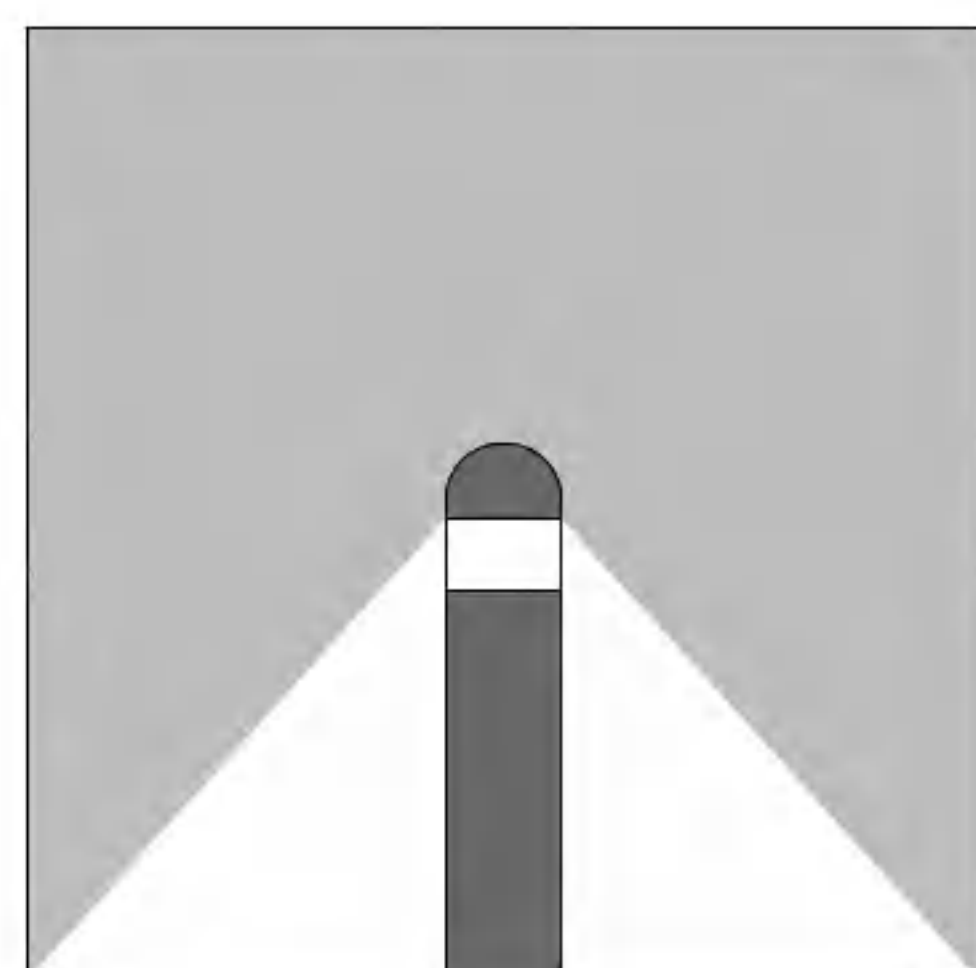

front view (正面图)



## Technical Date (技术参数)

Item No.	Lamp Type	Power	LM	CCT	PF	Voltage	CRI	A	B	C (mm)
MB18-C002A-300	LED	6W	420	2700K-6000K	0.6	AC110-265V	80-90	Ø90	160	300
MB18-C002A-600	LED	6W	420	2700K-6000K	0.6	AC110-265V	80-90	Ø90	460	600
MB18-C002A-900	LED	6W	420	2700K-6000K	0.6	AC110-265V	80-90	Ø90	760	900
MB18-C002B-300	LED	9W	630	2700K-6000K	0.6	AC110-265V	80-90	Ø108	143	300
MB18-C002B-600	LED	9W	630	2700K-6000K	0.6	AC110-265V	80-90	Ø108	443	600
MB18-C002B-900	LED	9W	630	2700K-6000K	0.6	AC110-265V	80-90	Ø108	743	900
MB18-C002C-300	LED	12W	840	2700K-6000K	0.6	AC110-265V	80-90	Ø150	104	300
MB18-C002C-600	LED	12W	840	2700K-6000K	0.6	AC110-265V	80-90	Ø150	404	600
MB18-C002C-900	LED	12W	840	2700K-6000K	0.6	AC110-265V	80-90	Ø150	704	900



# MB18-C013

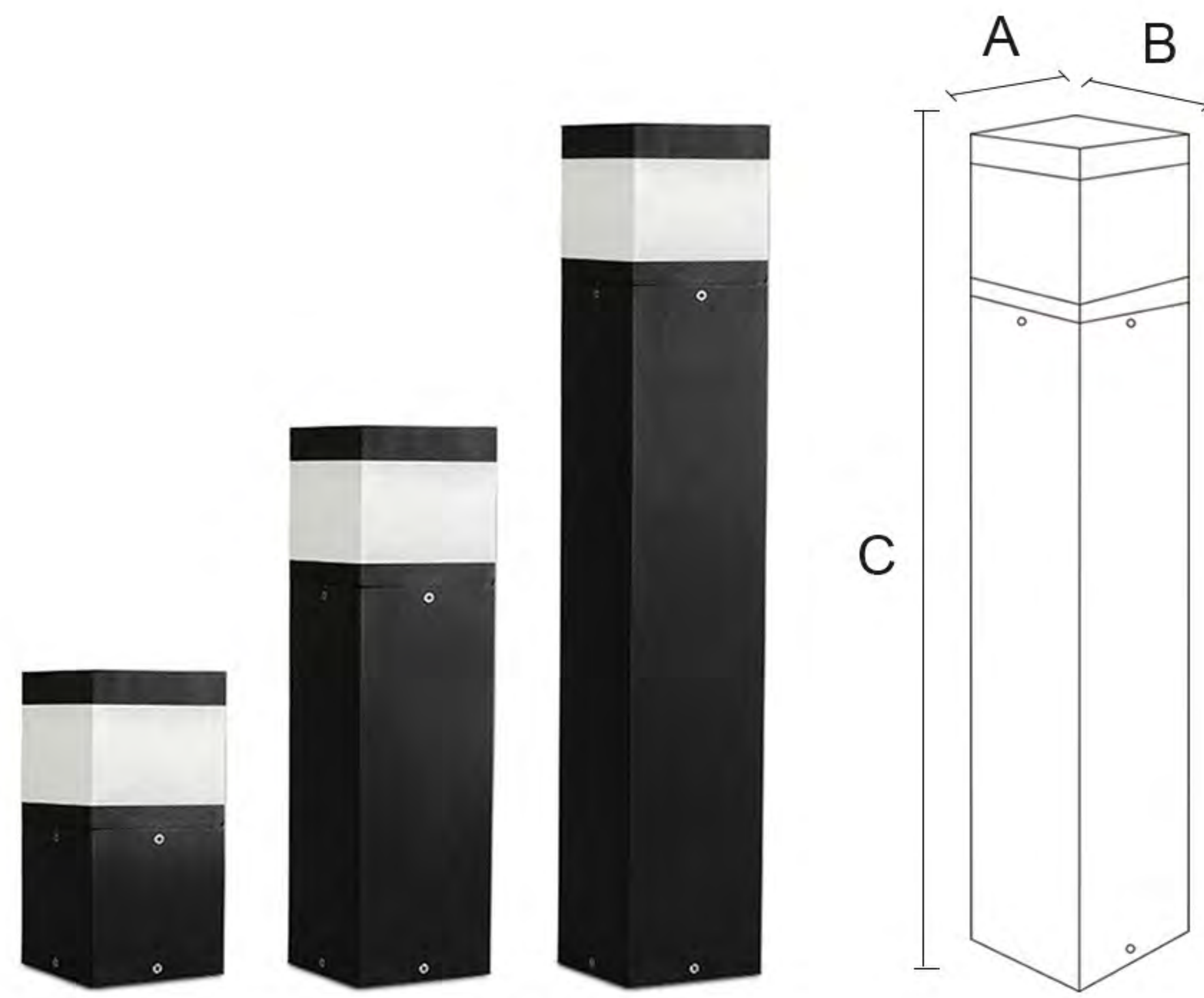

## Features&Benefit (功能和优点)

Category (品类)	Garden Light
Diffuser Material (扩散器材质)	PC
Cover Material (面盖材质)	Aluminum
Operating mode (运行)	Built in
Steuerbar (开关)	On/Off
IP (防水等级)	54
Mounting type (安装类型)	Put
Mounting location (安装位置)	Overground
Application environment (应用环境)	Indoor/Outdoor
Body color (表面颜色)	Black/Dark Gray/Sliver Gray



## Product Description (产品描述)

Suitable for parks and gardens, neighborhoods, villas, city squares, pedestrian streets, scenic spots or resorts and other various scenes; lawn lamps can be a variety of heights at the same time the lighting effect will be different, more to provide a choice.

## Lightmap (光影图)

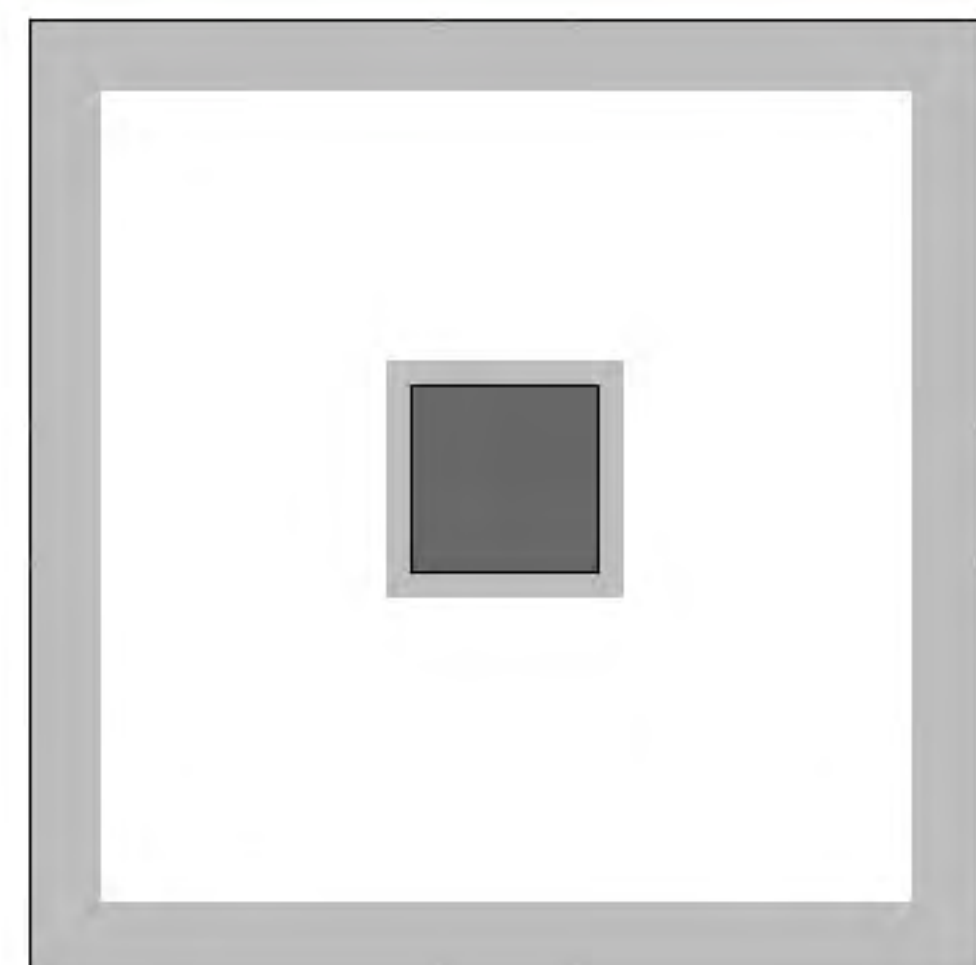

top view (俯视图)

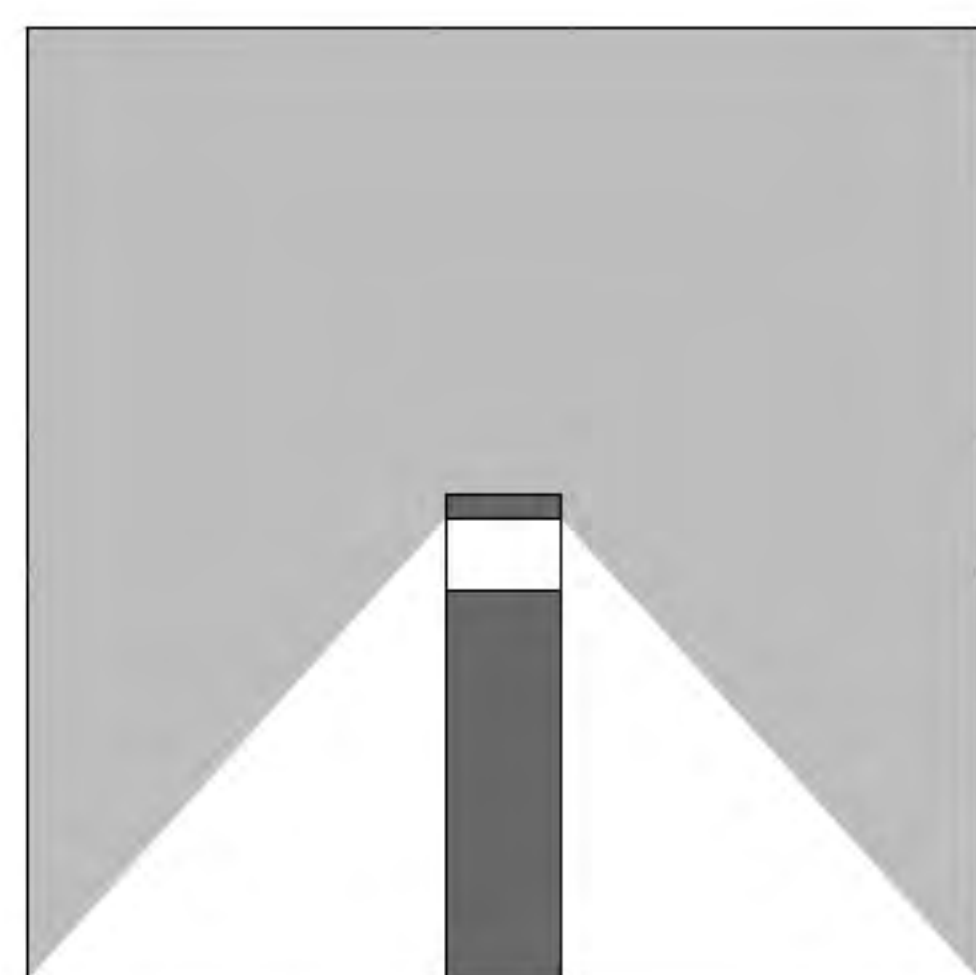

front view (正面图)

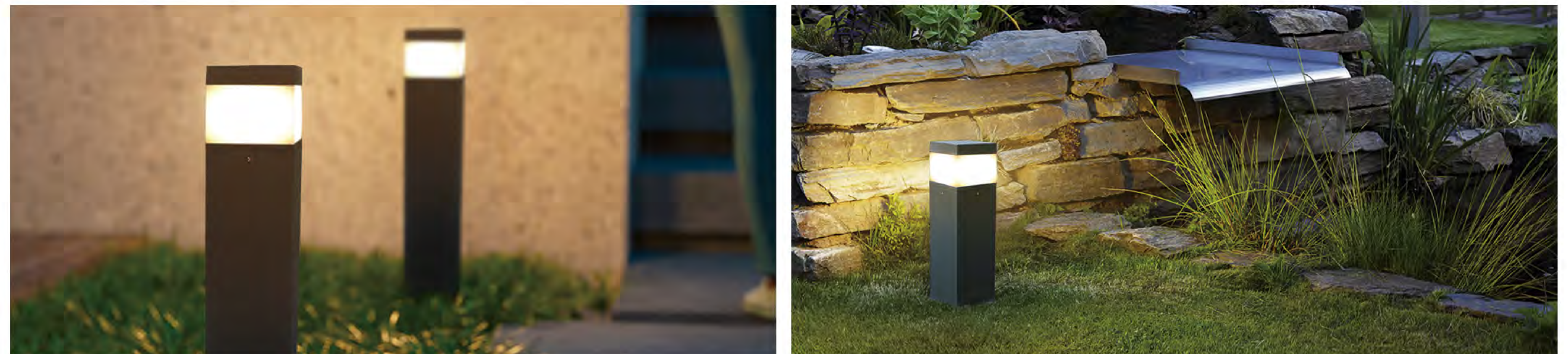

## Technical Date (技术参数)

Item No.	Lamp Type	Power	LM	CCT	PF	Voltage	CRI	A	B	C (mm)
MB18-C013A	LED	12W	840	2700K-6000K	0.6	AC110-265V	80-90	150	150	200
MB18-C013B	LED	12W	840	2700K-6000K	0.6	AC110-265V	80-90	150	150	500
MB18-C013C	LED	12W	840	2700K-6000K	0.6	AC110-265V	80-90	150	150	800
MB18-C013A	E27	-	-	-	-	-	-	150	150	200
MB18-C013B	E27	-	-	-	-	-	-	150	150	500
MB18-C013C	E27	-	-	-	-	-	-	150	150	800



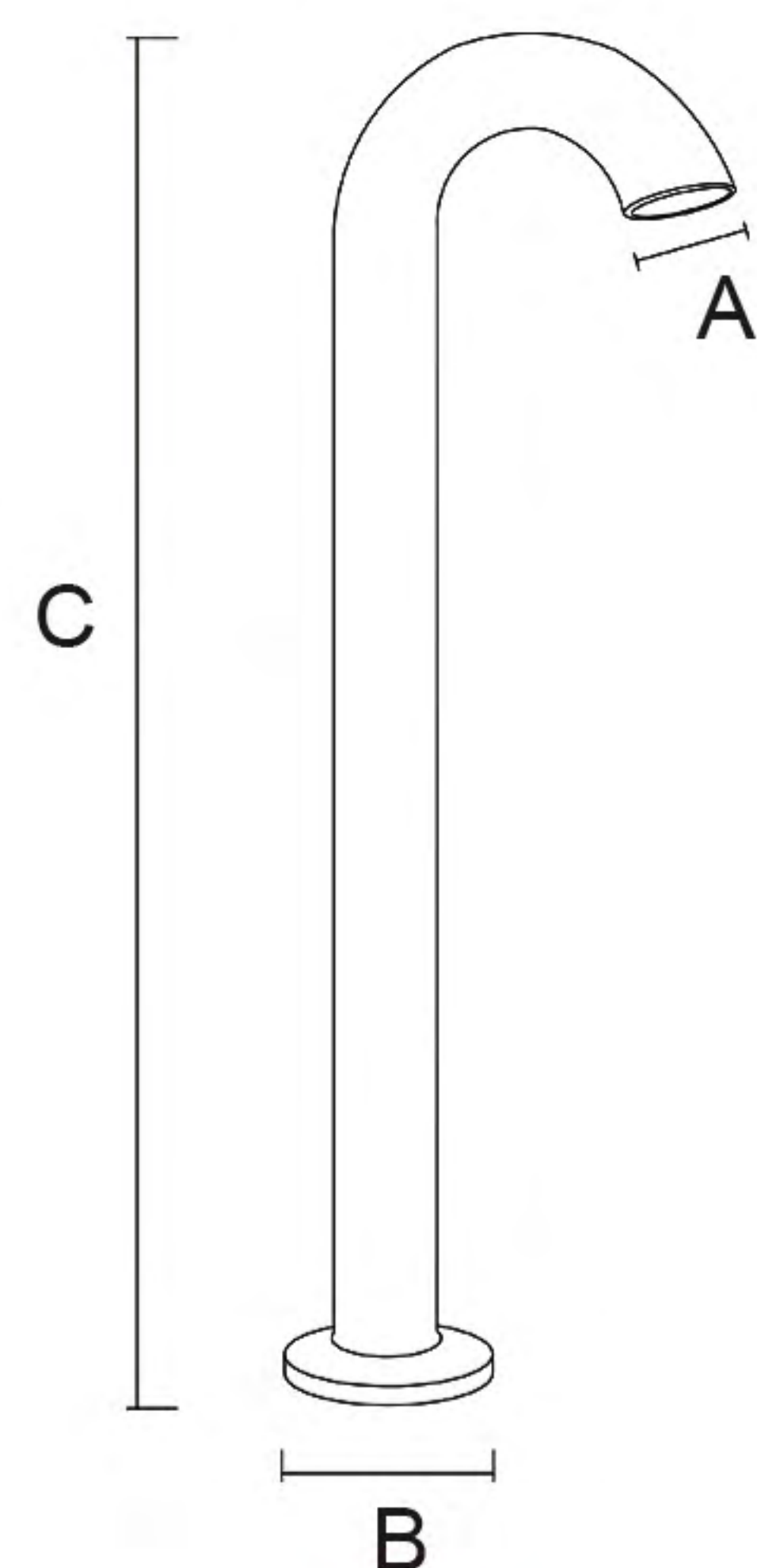

# MB18-C014

## Features&Benefit (功能和优点)

Category (品类)	Garden Light
Diffuser Material (扩散器材质)	PC
Cover Material (面盖材质)	Aluminum
Operating made (运行)	Built in
Steuerbar (开关)	On/Off
IP (防水等级)	54
Mounting type (安装类型)	Put
Mounting location (安装位置)	Overground
Application environment (应用环境)	Indoor/Outdoor
Body color (表面颜色)	Black/Dark Gray/Sliver Gray



## Product Description (产品描述)

Suitable for urban slow lane, narrow lanes, residential neighborhoods, tourist attractions, parks, squares, private gardens, courtyard corridors and other public places of the road on one side or both sides of the road lighting; unique design, soft light, so that the scene is full of layers.

## Lightmap (光影图)

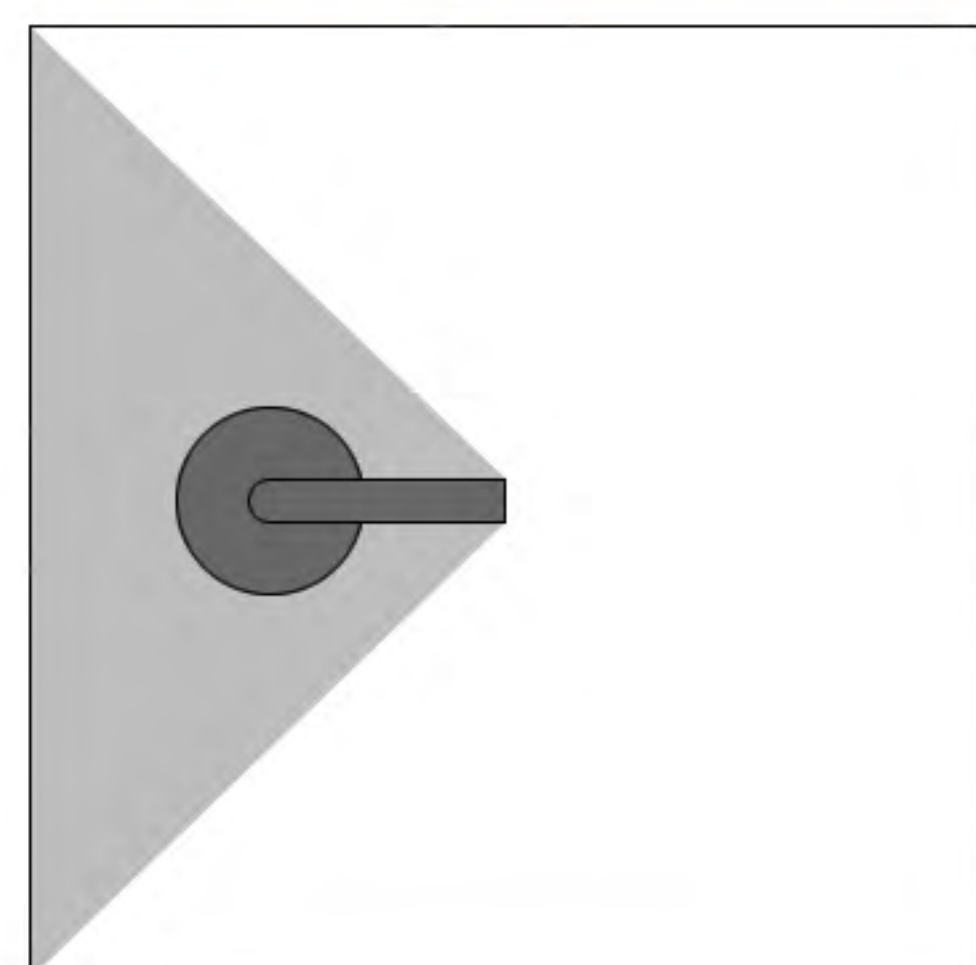

top view (俯视图)

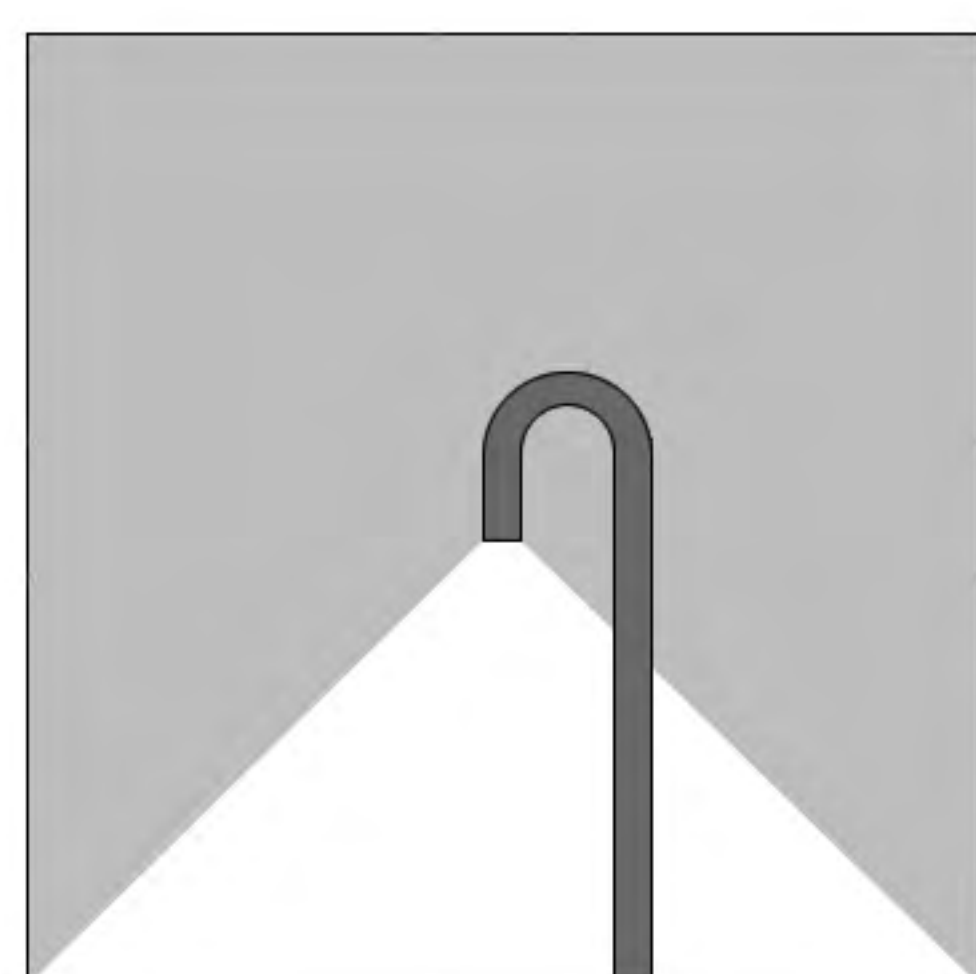

front view (正面图)



## Technical Date (技术参数)

Item No.	Lamp Type	Power	LM	CCT	PF	Voltage	CRI	A	B	C (mm)
MB18-C014	LED	5W	350	2700K-6000K	0.6	AC110-265V	80-90	Ø30	Ø90	600



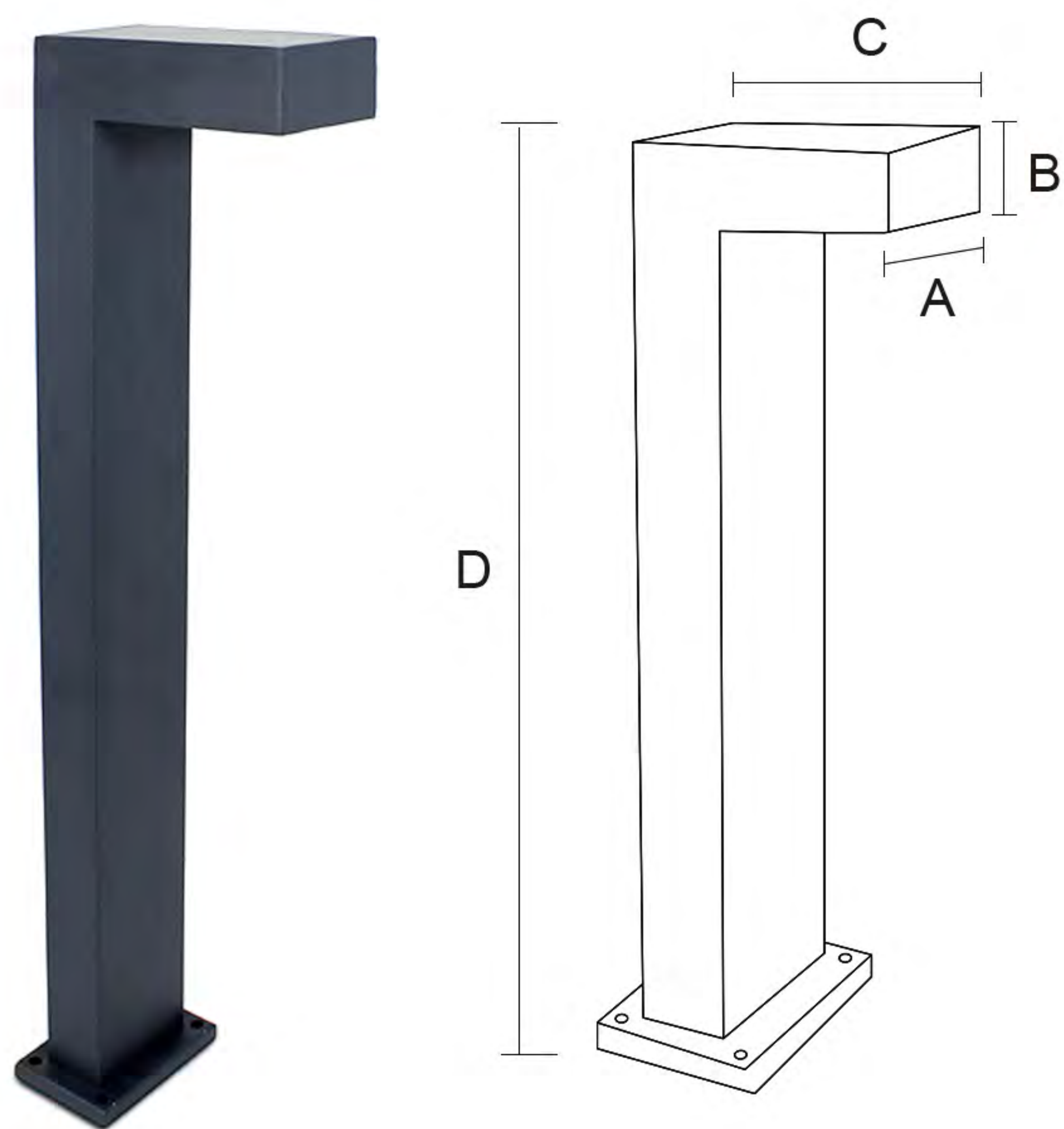

# MB18-C021

## Features&Benefit (功能和优点)

Category (品类)	Garden Light
Diffuser Material (扩散器材质)	Glass
Cover Material (面盖材质)	Aluminum
Operating mode (运行)	Built in
Steuerbar (开关)	On/Off
IP (防水等级)	54
Mounting type (安装类型)	Put
Mounting location (安装位置)	Overground
Application environment (应用环境)	Indoor/Outdoor
Body color (表面颜色)	Black/Dark Gray/Sliver Gray



## Product Description (产品描述)

Suitable for urban slow lane, narrow lanes, residential neighborhoods, tourist attractions, parks, squares, private gardens, courtyard corridors and other public places of the road on one side or both sides of the road lighting; unique design, soft light, so that the scene is full of layers.

## Lightmap (光影图)

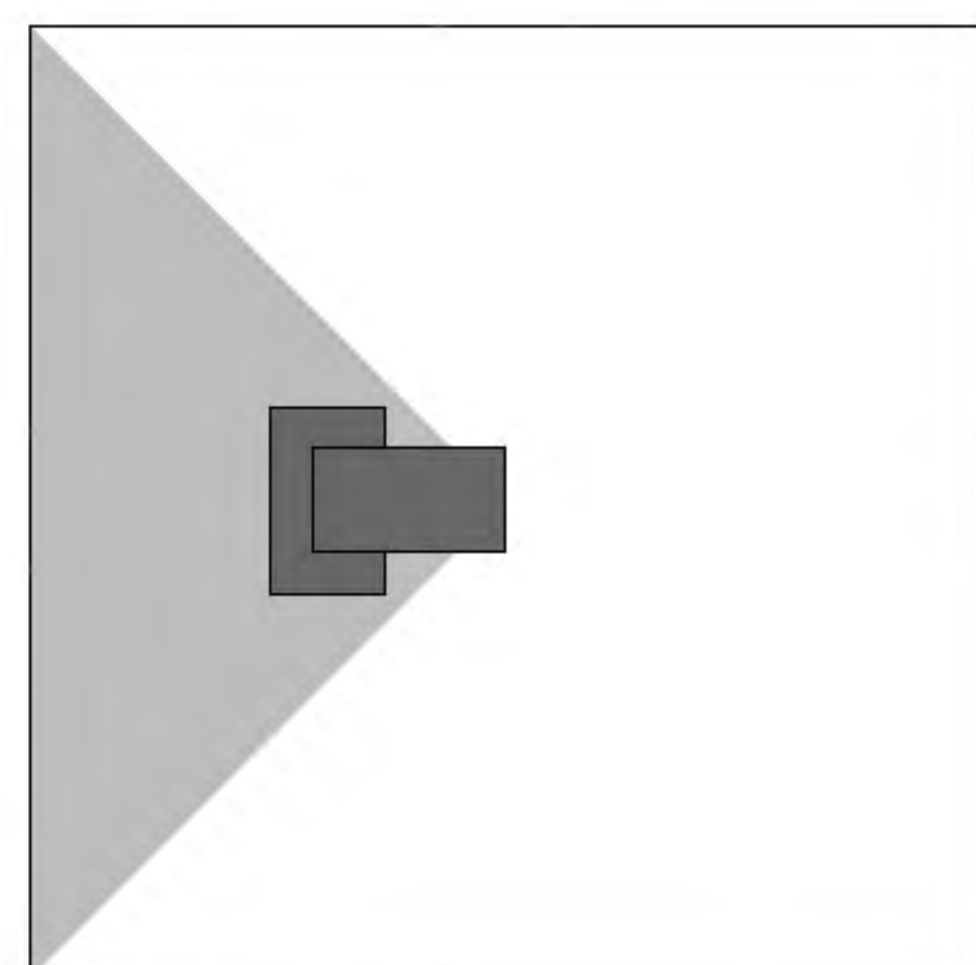

top view (俯视图)

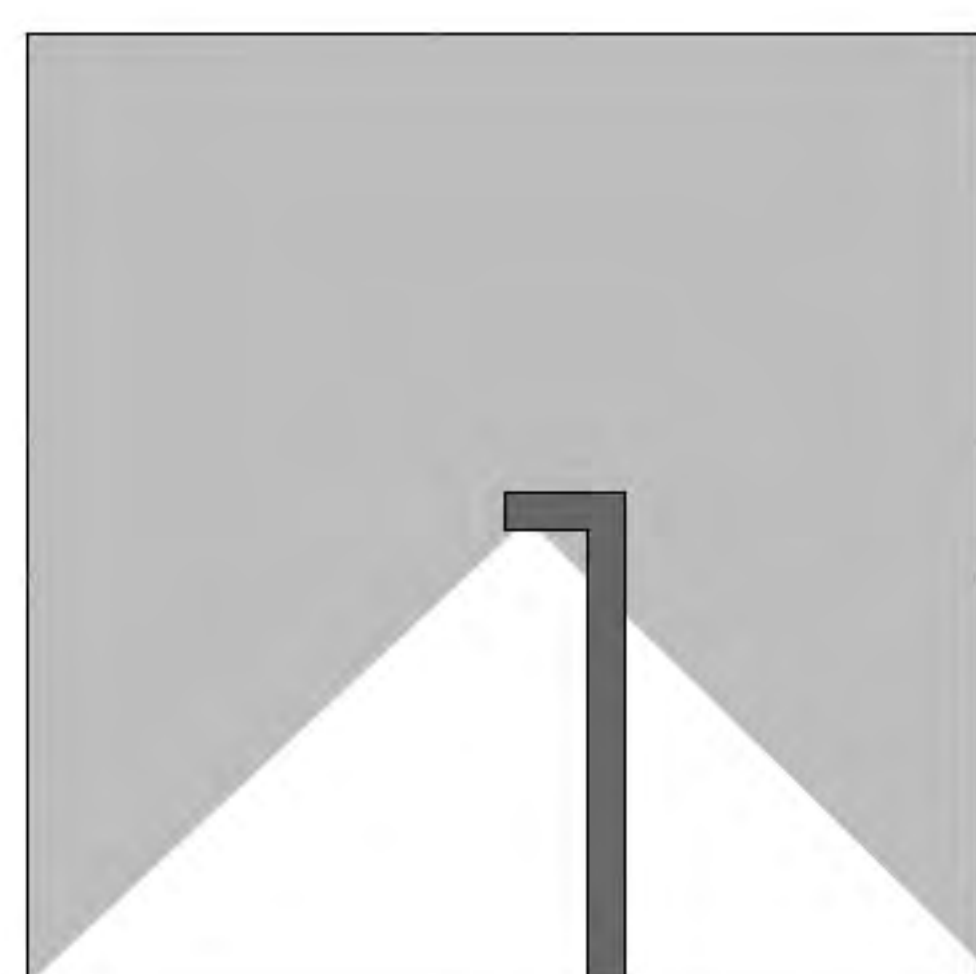

front view (正面图)



## Technical Date (技术参数)

Item No.	Lamp Type	Power	LM	CCT	PF	Voltage	CRI	A	B	C	D(mm)
MB18-C021A	LED	10W	700	2700K-6000K	0.6	AC110-265V	80-90	100	50	200	600
MB18-C021B	LED	10W	700	2700K-6000K	0.6	AC110-265V	80-90	150	80	200	600



# MB18-C022

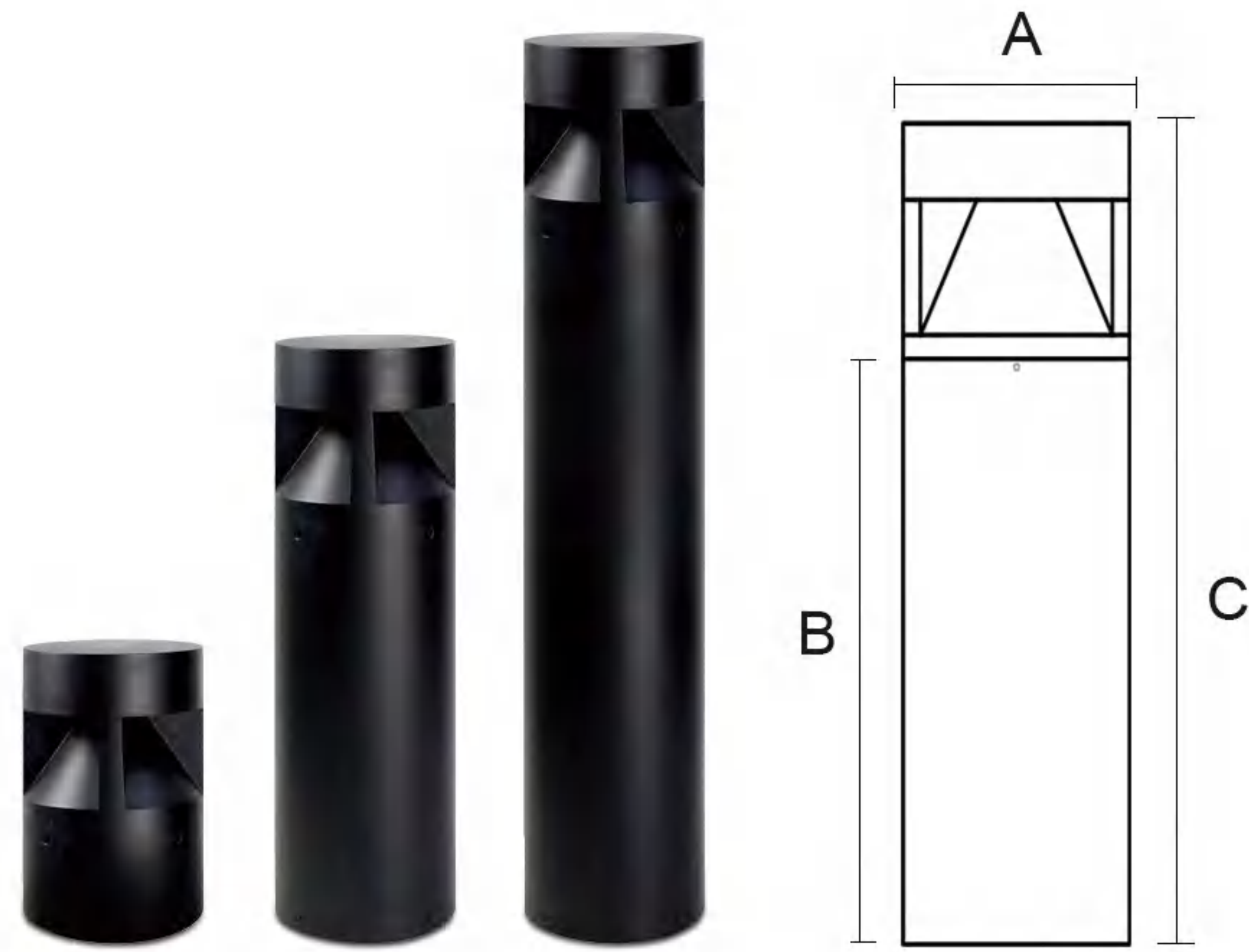

## Features&Benefit (功能和优点)

Category (品类)	Garden Light
Diffuser Material (扩散器材质)	PC
Cover Material (面盖材质)	Aluminum
Operating mode (运行)	Built in
Steuerbar (开关)	On/Off
IP (防水等级)	54
Mounting type (安装类型)	Put
Mounting location (安装位置)	Overground
Application environment (应用环境)	Indoor/Outdoor
Body color (表面颜色)	Black/Dark Gray/Sliver Gray



## Product Description (产品描述)

Suitable for parks and gardens, neighborhoods, villas, city squares, pedestrian streets, scenic spots or resorts and other various scenes; lawn lamps can be a variety of heights at the same time the lighting effect will be different, more to provide a choice.

## Lightmap (光影图)



top view (俯视图)

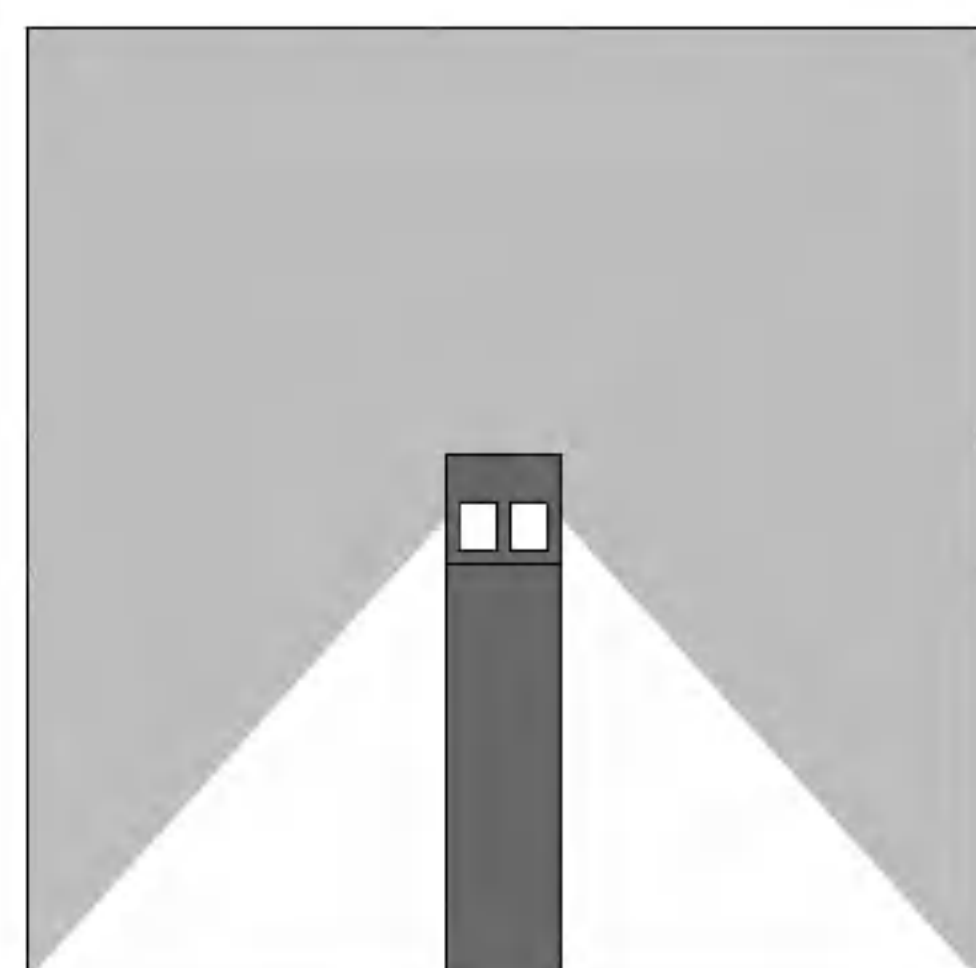

front view (正面图)



## Technical Date (技术参数)

Item No.	Lamp Type	Power	LM	CCT	PF	Voltage	CRI	A	B	C (mm)
MB18-C022A/150	LED	12W	840	2700K-6000K	0.6	AC110-265V	80-90	Ø150	60	200
MB18-C022B/150	LED	12W	840	2700K-6000K	0.6	AC110-265V	80-90	Ø150	360	500
MB18-C022C/150	LED	12W	840	2700K-6000K	0.6	AC110-265V	80-90	Ø150	660	800
MB18-C022A/200	LED	20W	1400	2700K-6000K	0.95	AC110-265V	80-90	Ø200	60	200
MB18-C022B/200	LED	20W	1400	2700K-6000K	0.95	AC110-265V	80-90	Ø200	360	500
MB18-C022C/200	LED	20W	1400	2700K-6000K	0.95	AC110-265V	80-90	Ø200	660	800



# MB18-C023

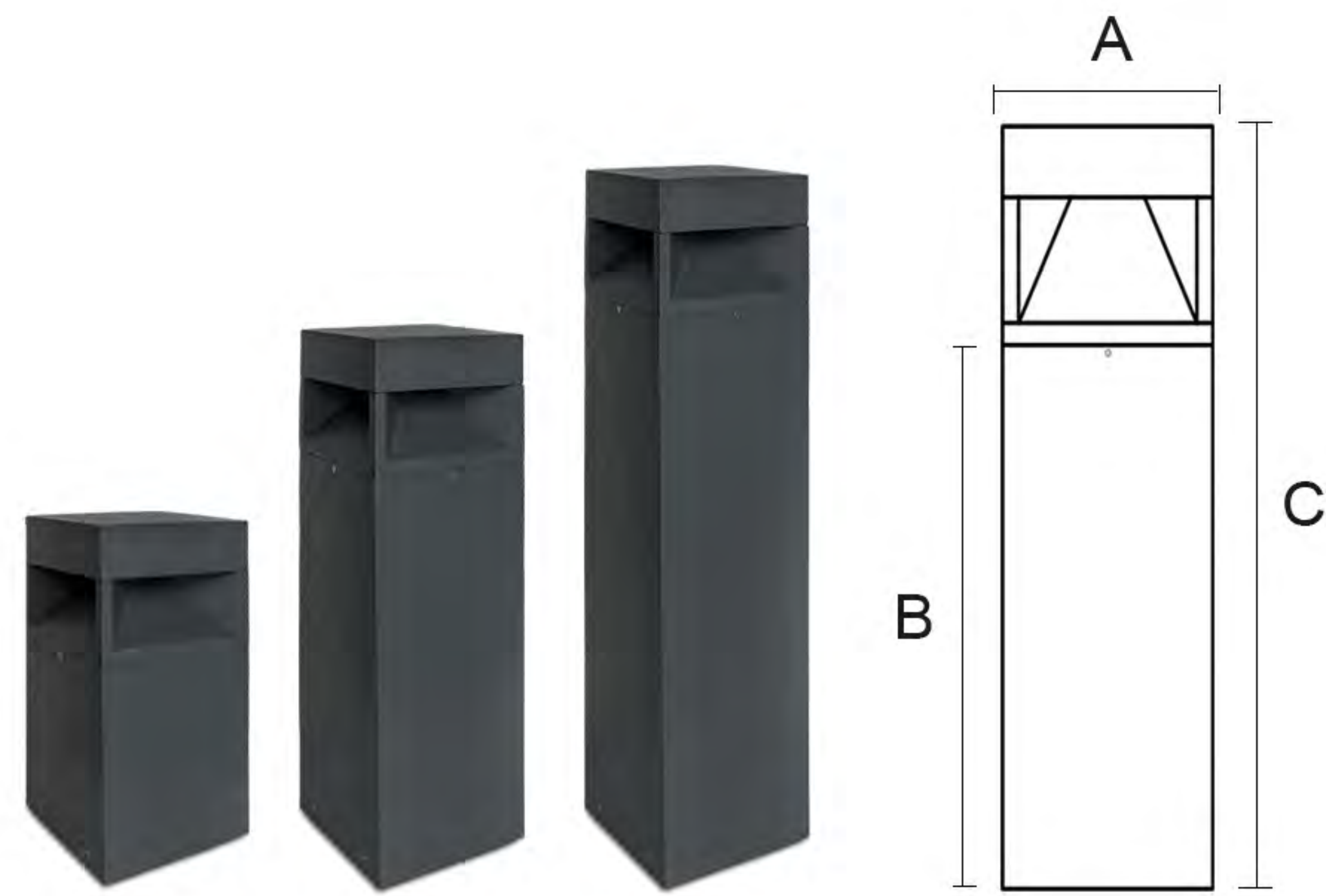

## Features&Benefit (功能和优点)

Category (品类)	Garden Light
Diffuser Material (扩散器材质)	PC
Cover Material (面盖材质)	Aluminum
Operating mode (运行)	Built in
Steuerbar (开关)	On/Off
IP (防水等级)	54
Mounting type (安装类型)	Put
Mounting location (安装位置)	Overground
Application environment (应用环境)	Indoor/Outdoor
Body color (表面颜色)	Black/Dark Gray/Sliver Gray



## Product Description (产品描述)

Suitable for parks and gardens, neighborhoods, villas, city squares, pedestrian streets, scenic spots or resorts and other various scenes; lawn lamps can be a variety of heights at the same time the lighting effect will be different, more to provide a choice.

## Lightmap (光影图)

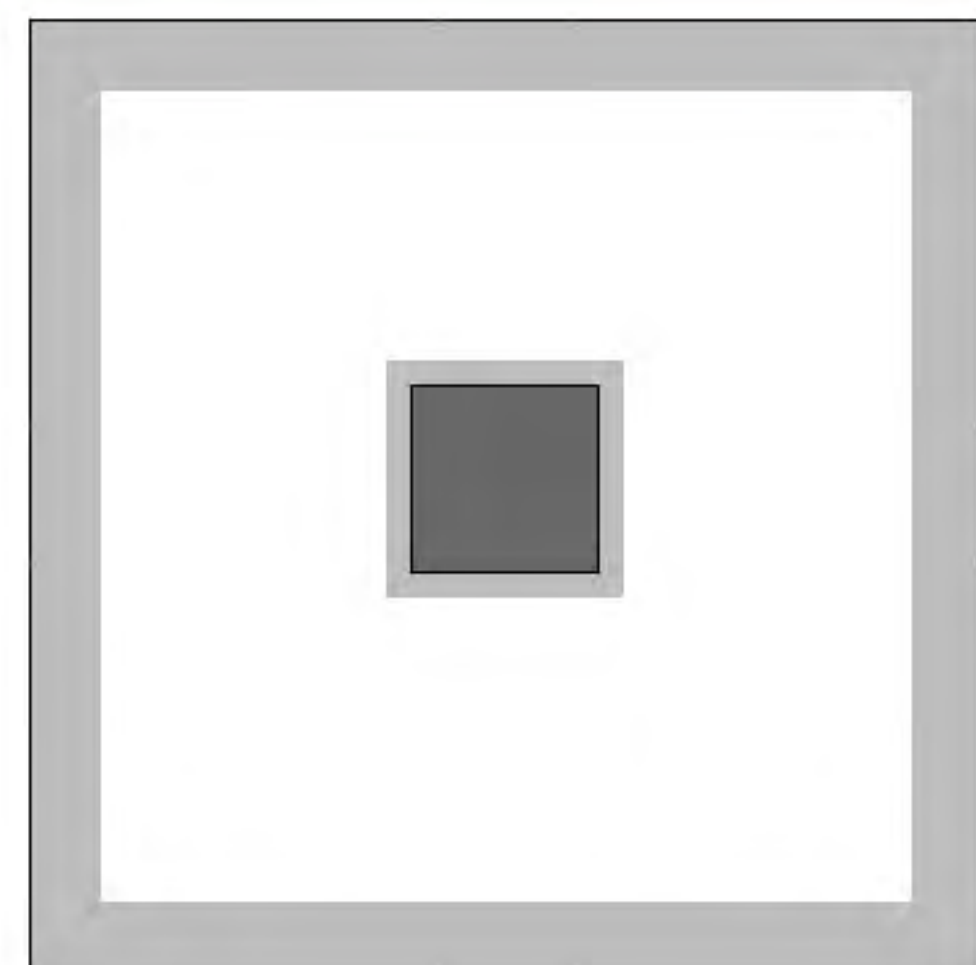

top view (俯视图)

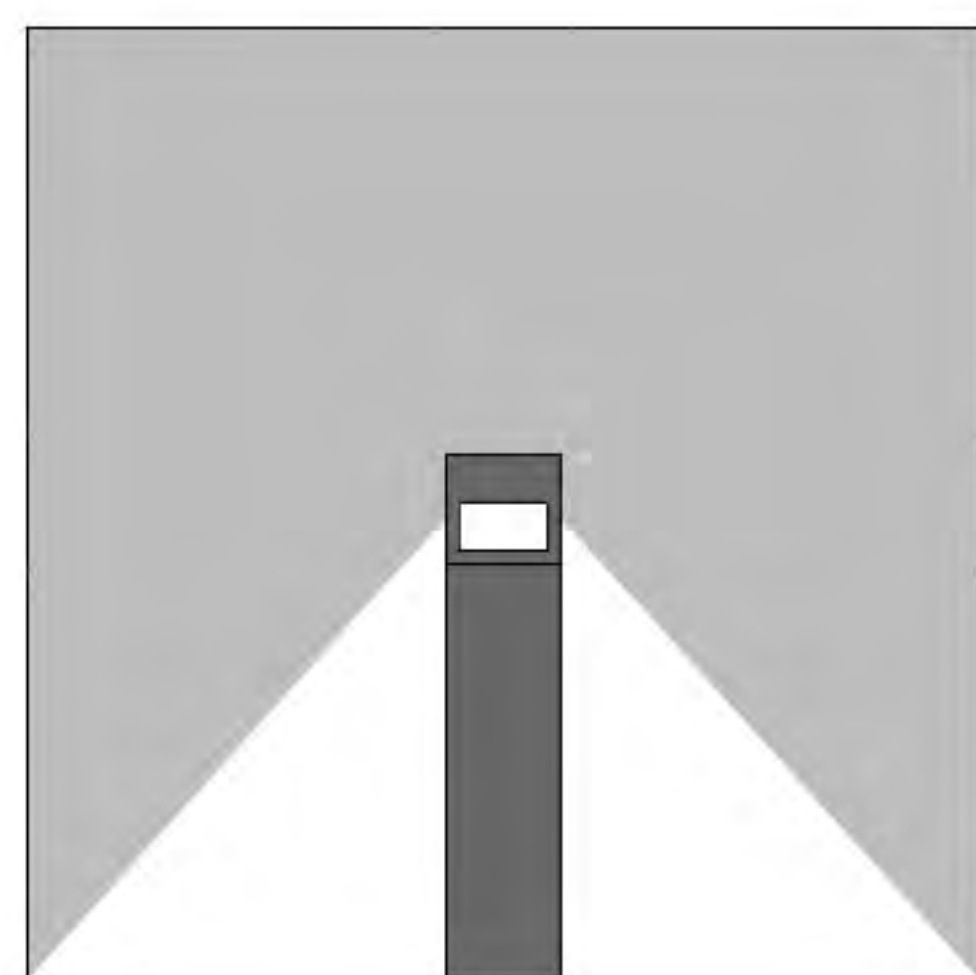

front view (正面图)

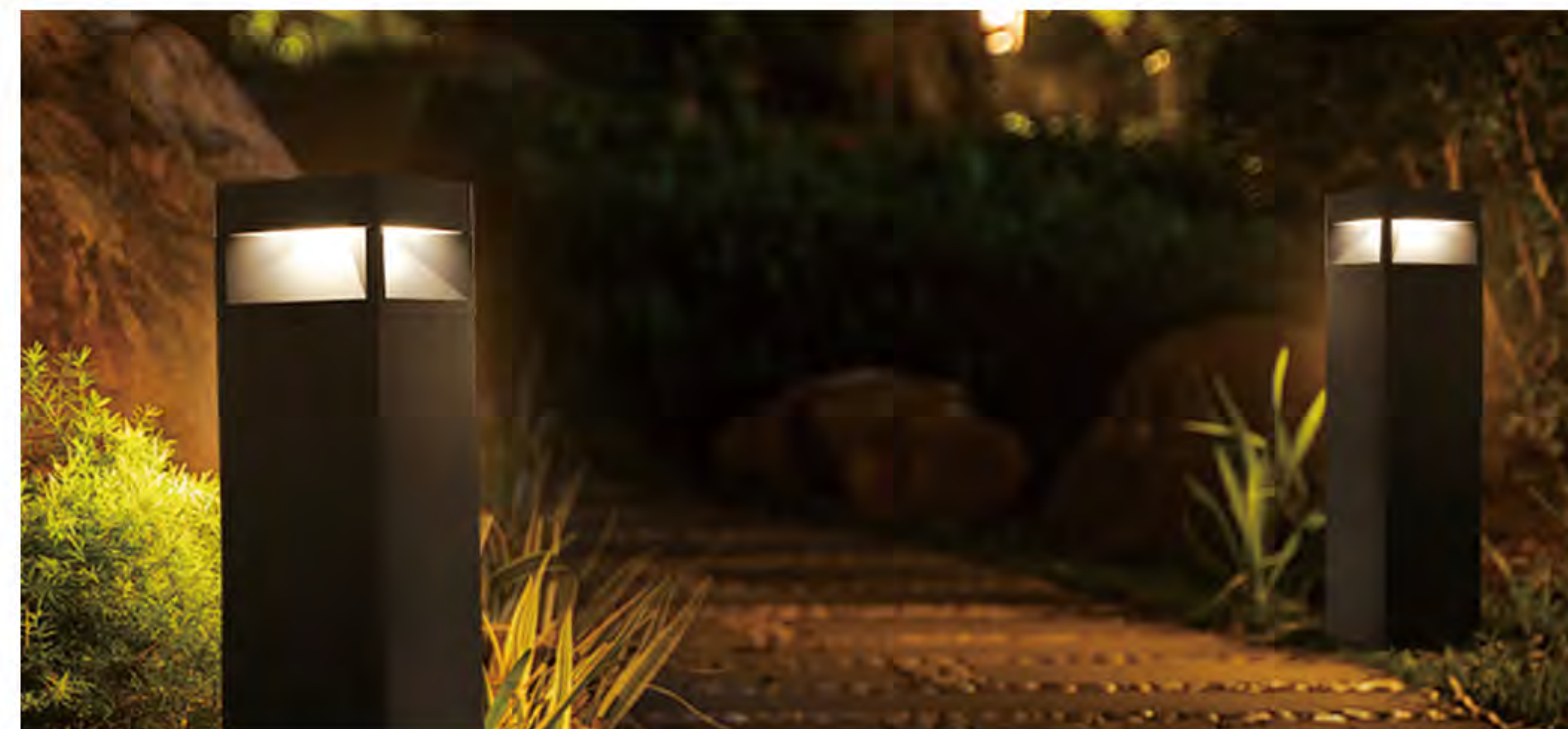

## Technical Date (技术参数)

Item No.	Lamp Type	Power	LM	CCT	PF	Voltage	CRI	A	B	C (mm)
MB18-C023A/150	LED	12W	840	2700K-6000K	0.6	AC110-265V	80-90	150	60	200
MB18-C023B/150	LED	12W	840	2700K-6000K	0.6	AC110-265V	80-90	150	360	500
MB18-C023C/150	LED	12W	840	2700K-6000K	0.6	AC110-265V	80-90	150	660	800
MB18-C023A/200	LED	20W	1400	2700K-6000K	0.95	AC110-265V	80-90	200	60	200
MB18-C023B/200	LED	20W	1400	2700K-6000K	0.95	AC110-265V	80-90	200	360	500
MB18-C023C/200	LED	20W	1400	2700K-6000K	0.95	AC110-265V	80-90	200	660	800



# MB18-C024

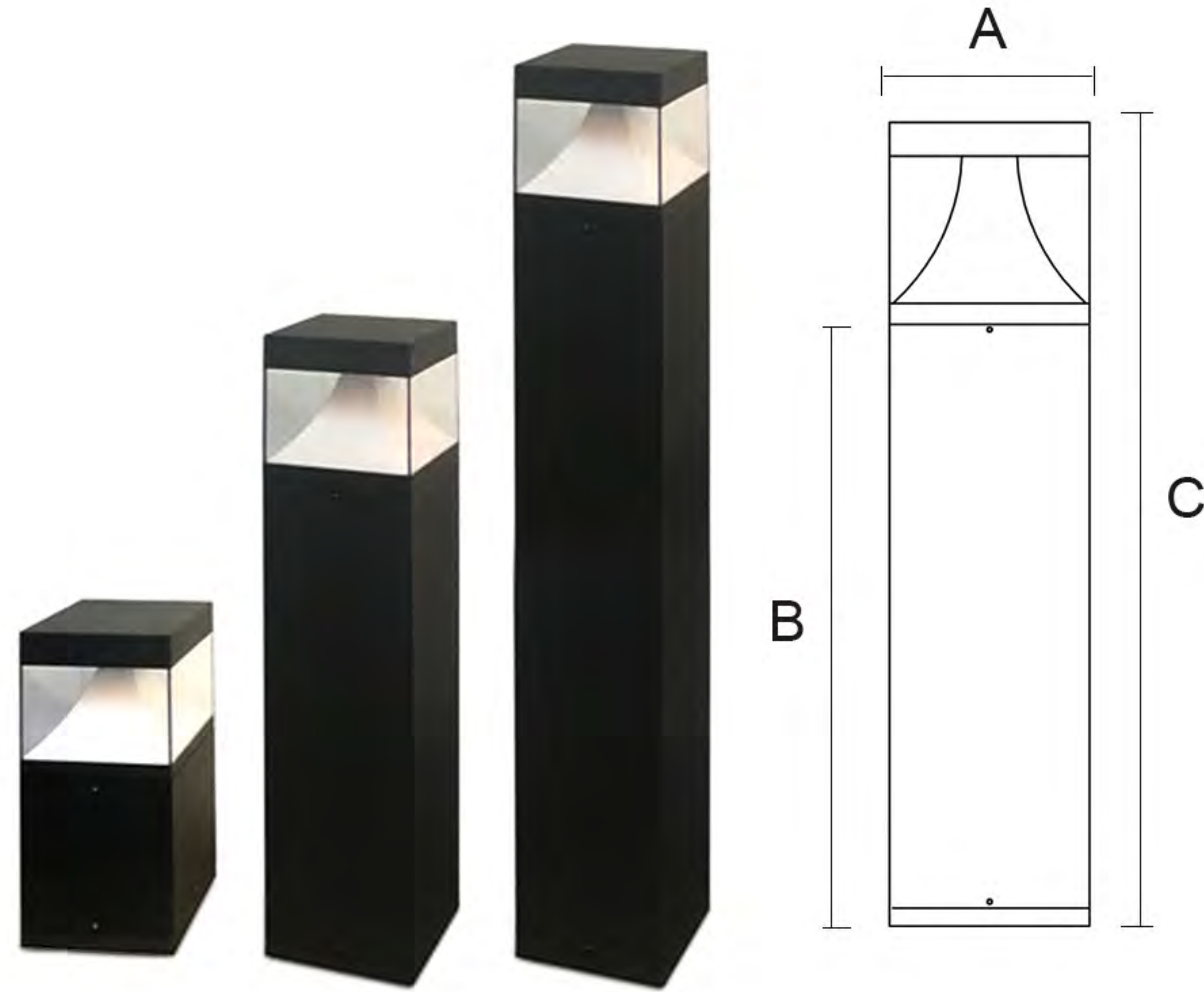

## Features&Benefit (功能和优点)

Category (品类)	Garden Light
Diffuser Material (扩散器材质)	PC
Cover Material (面盖材质)	Aluminum
Operating mode (运行)	Built in
Steuerbar (开关)	On/Off
IP (防水等级)	54
Mounting type (安装类型)	Put
Mounting location (安装位置)	Overground
Application environment (应用环境)	Indoor/Outdoor
Body color (表面颜色)	Black/Dark Gray/Sliver Gray



## Product Description (产品描述)

Suitable for parks and gardens, neighborhoods, villas, city squares, pedestrian streets, scenic spots or resorts and other various scenes; lawn lamps can be a variety of heights at the same time the lighting effect will be different, more to provide a choice.

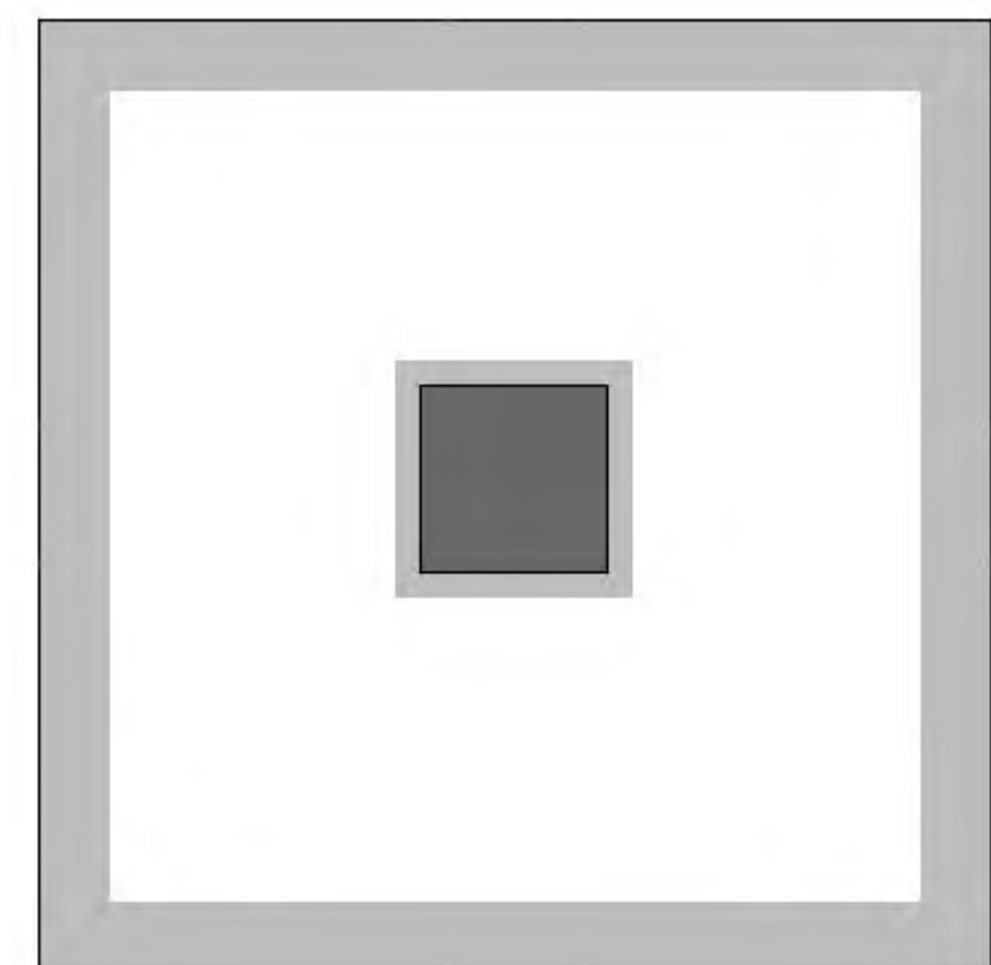

top view (俯视图)

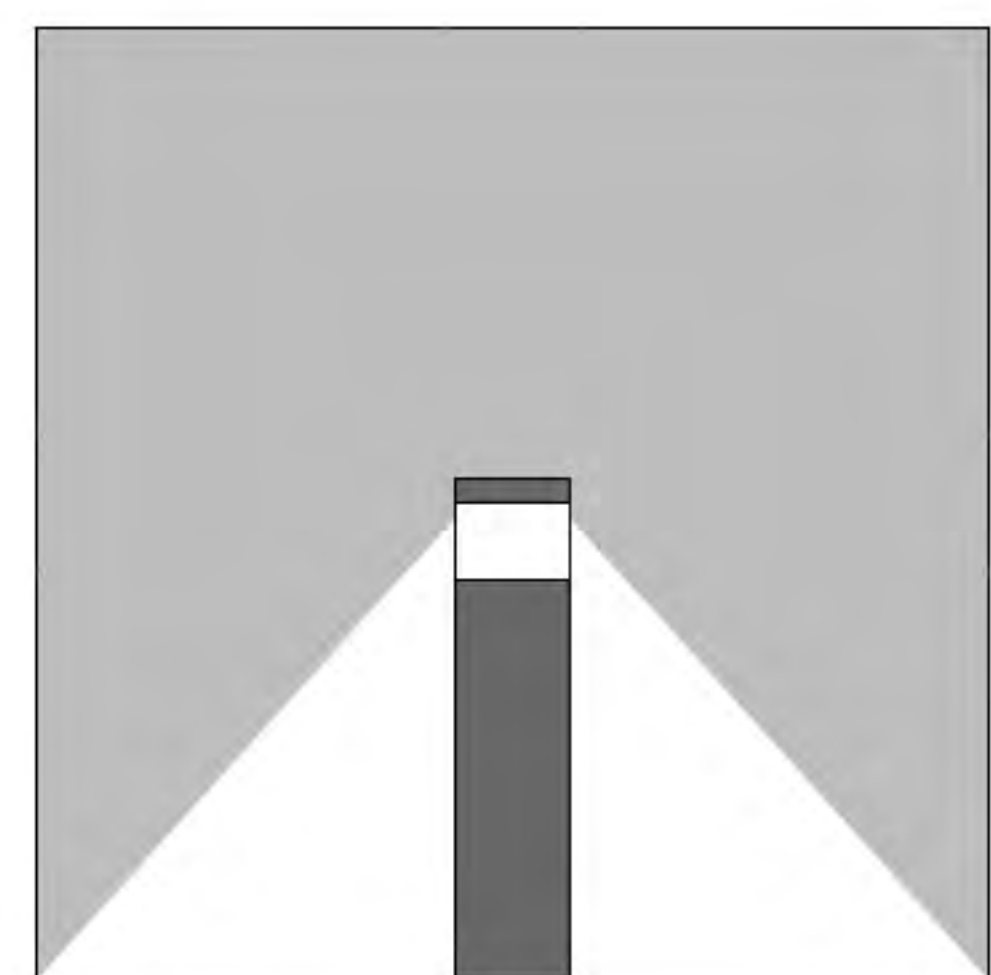

front view (正面图)



## Technical Date (技术参数)

Item No.	Lamp Type	Power	LM	CCT	PF	Voltage	CRI	A	B	C (mm)
MB18-C024A	LED	12W	840	2700K-6000K	0.6	AC110-265V	80-90	150	60	200
MB18-C024B	LED	12W	840	2700K-6000K	0.6	AC110-265V	80-90	150	360	500
MB18-C024C	LED	12W	840	2700K-6000K	0.6	AC110-265V	80-90	150	660	800



# MB19-C001

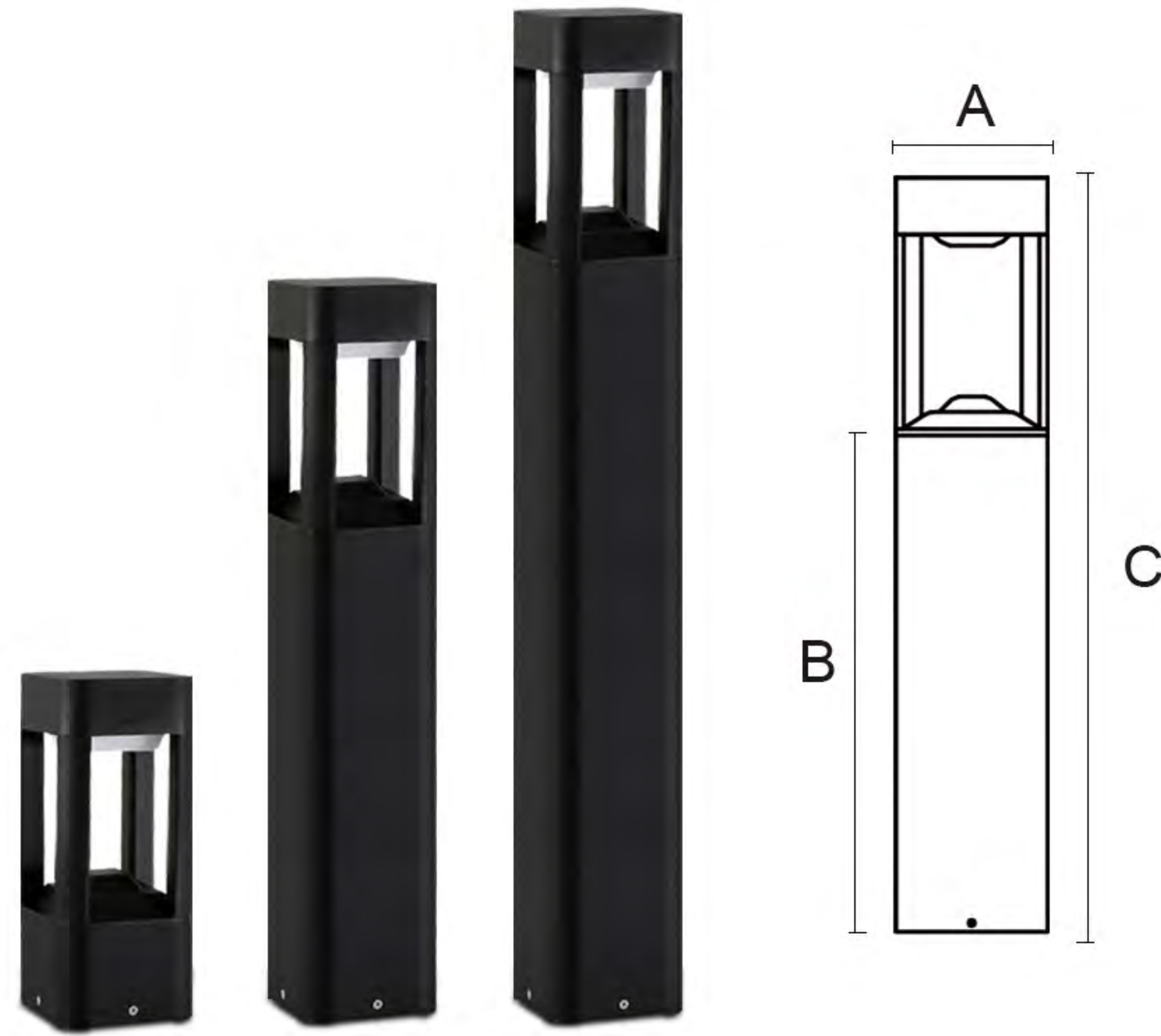

## Features&Benefit (功能和优点)

Category (品类)	Garden Light
Diffuser Material (扩散器材质)	PC
Cover Material (面盖材质)	Aluminum
Operating made (运行)	Built in
Steuerbar (开关)	On/Off
IP (防水等级)	54
Mounting type (安装类型)	Put
Mounting location (安装位置)	Overground
Application environment (应用环境)	Indoor/Outdoor
Body color (表面颜色)	Black/Dark Gray/Sliver Gray



## Product Description (产品描述)

Suitable for parks and gardens, neighborhoods, villas, city squares, pedestrian streets, scenic spots or resorts and other various scenes; lawn lamps can be a variety of heights at the same time the lighting effect will be different, more to provide a choice.

## Lightmap (光影图)

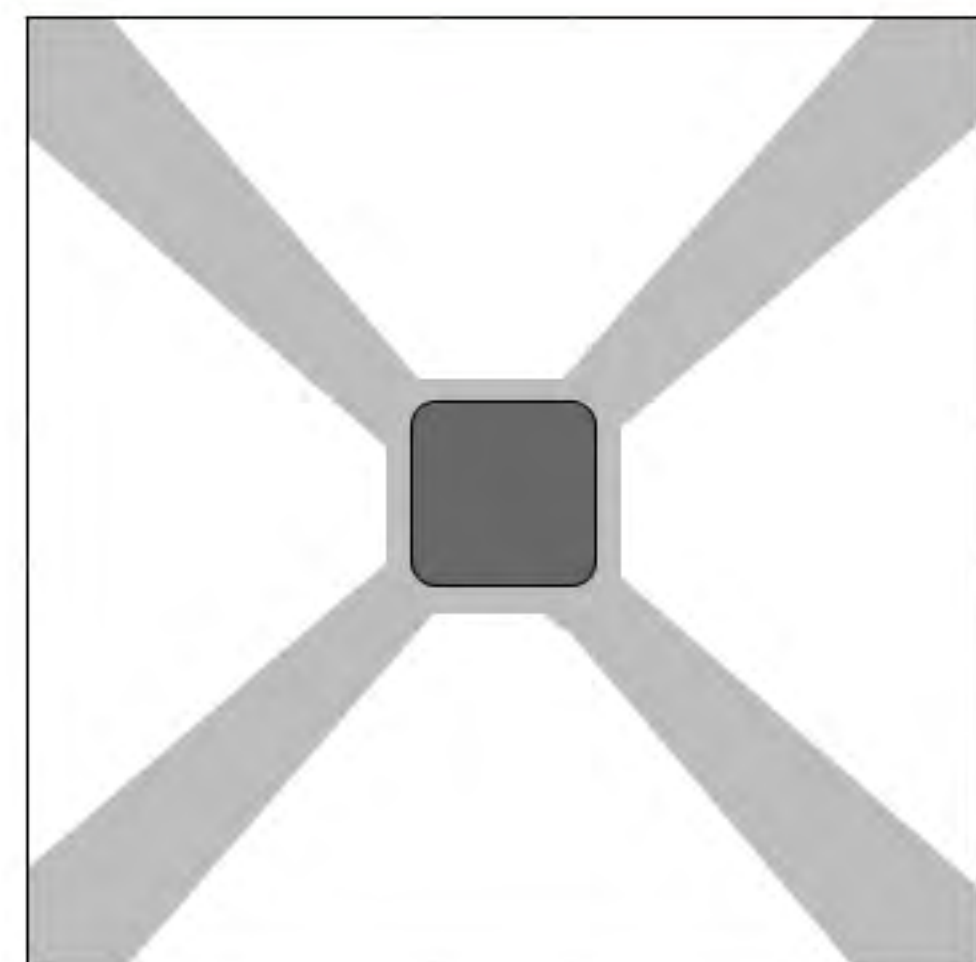

top view (俯视图)

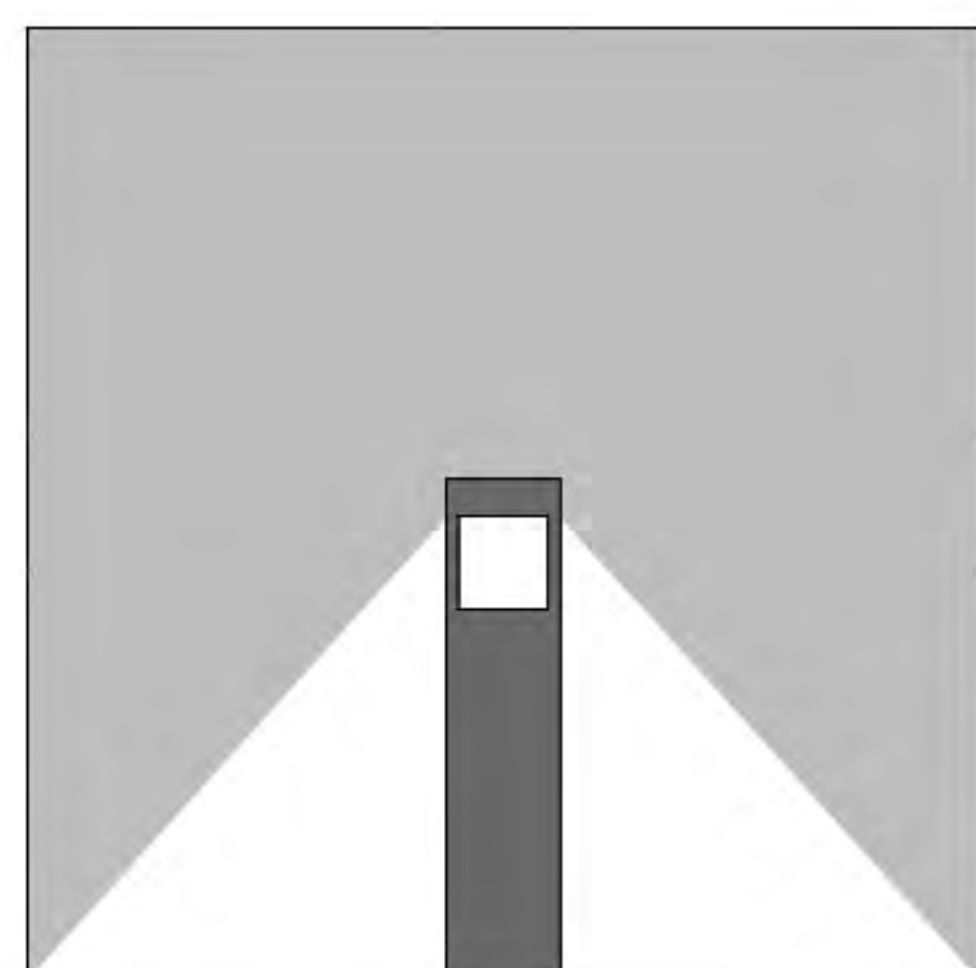

front view (正面图)



## Technical Date (技术参数)

Item No.	Lamp Type	Power	LM	CCT	PF	Voltage	CRI	A	B	C (mm)
MB19-C001A	LED	10W	700	2700K-6000K	0.6	AC110-265V	80-90	120	100	300
MB19-C001B	LED	10W	700	2700K-6000K	0.6	AC110-265V	80-90	120	400	600
MB19-C001C	LED	10W	700	2700K-6000K	0.6	AC110-265V	80-90	120	700	900



# MB19-C001-SL

# SOLAR LIGHT

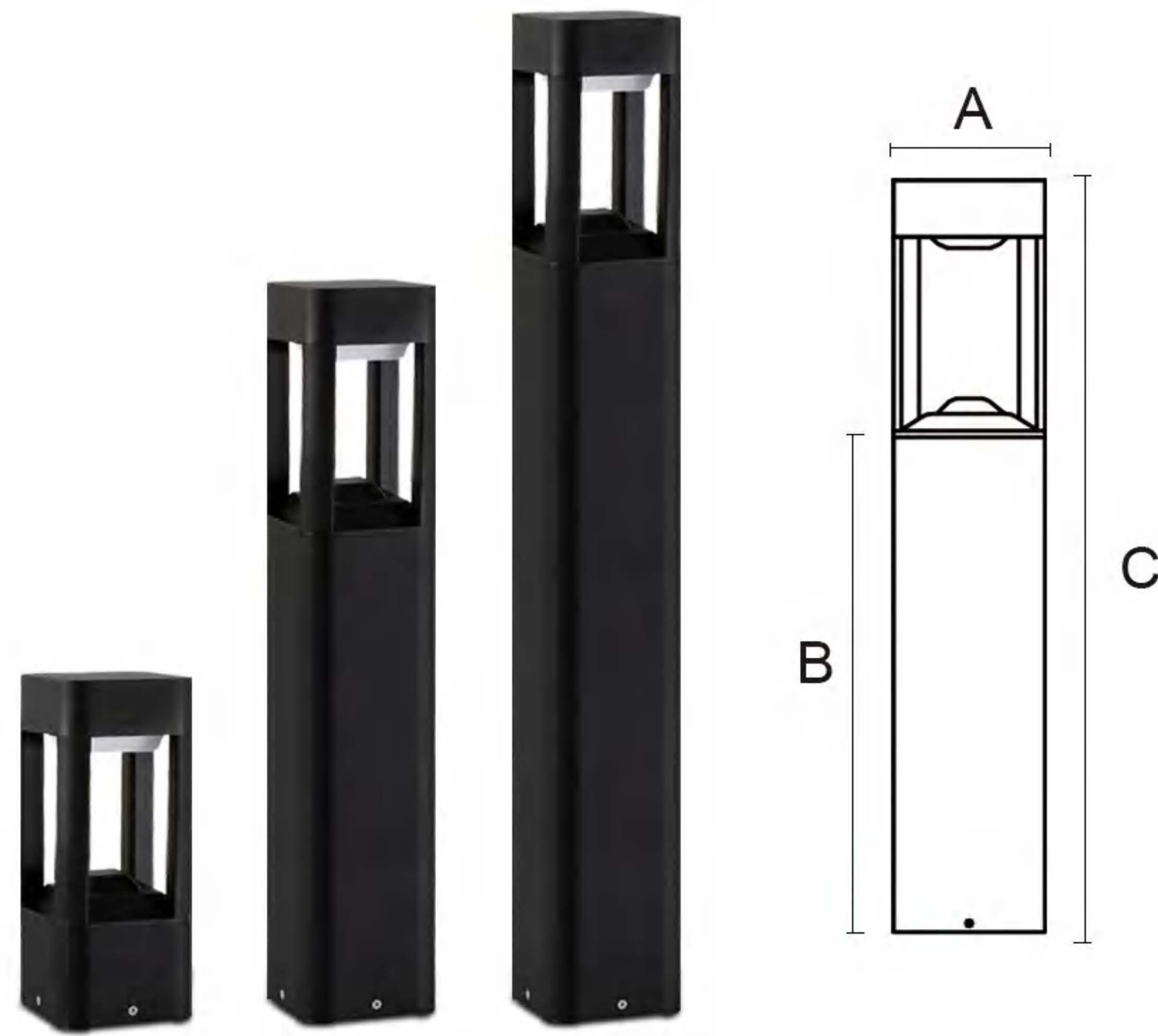

## Features&Benefit (功能和优点)

Category (品类)	Garden Light
Diffuser Material (扩散器材质)	PC
Cover Material (面盖材质)	Aluminum+Solar Panel
Operating mode (运行)	Built in
Steuerbar (开关)	On/Off
Working Hours (工作时长)	8 Hours
IP (防水等级)	54
Mounting type (安装类型)	Put
Mounting location (安装位置)	Overground
Application environment (应用环境)	Indoor/Outdoor
Body color (表面颜色)	Black

## Product Description (产品描述)

Suitable for parks and gardens, neighborhoods, villas, city squares, pedestrian streets, scenic spots or resorts and other various scenes; lawn lamps can be a variety of heights at the same time the lighting effect will be different, more to provide a choice.

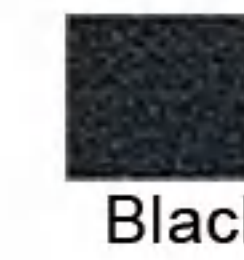

Black



Solar Panel



No/Off



## Technical Date (技术参数)

Item No.	Lamp Type	Power	LM	CCT	CRI	A	B	C (mm)
MB19-C001A-SL	LED	3W	210	2700K-6000K	80-90	120	100	300
MB19-C001B-SL	LED	3W	210	2700K-6000K	80-90	120	400	600
MB19-C001C-SL	LED	3W	210	2700K-6000K	80-90	120	700	900



# MB19-C002

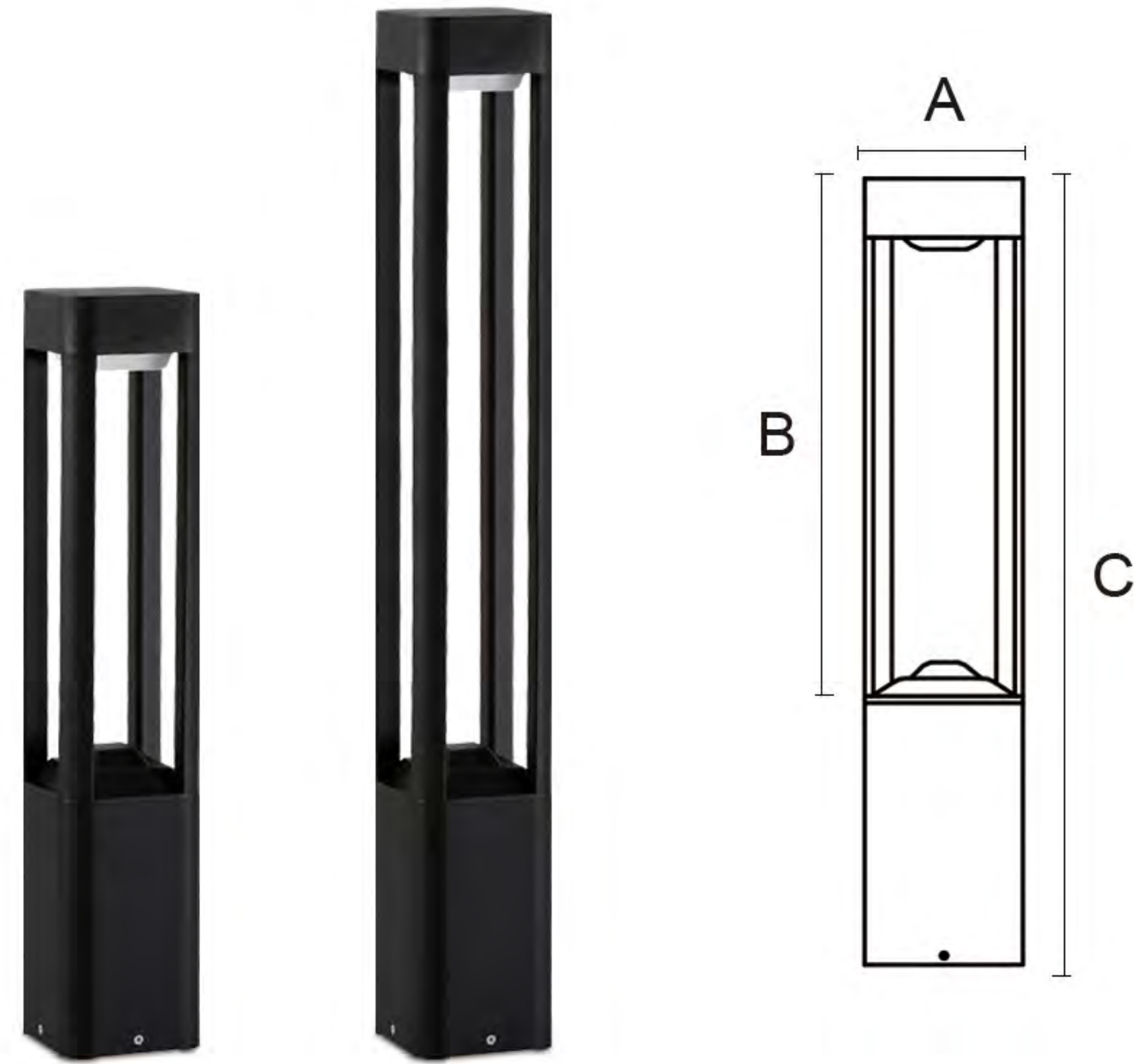

## Features&Benefit (功能和优点)

Category (品类)	Garden Light
Diffuser Material (扩散器材质)	PC
Cover Material (面盖材质)	Aluminum
Operating mode (运行)	Built in
Steuerbar (开关)	On/Off
IP (防水等级)	54
Mounting type (安装类型)	Put
Mounting location (安装位置)	Overground
Application environment (应用环境)	Indoor/Outdoor
Body color (表面颜色)	Black/Dark Gray/Sliver Gray



## Product Description (产品描述)

Suitable for parks and gardens, neighborhoods, villas, city squares, pedestrian streets, scenic spots or resorts and other various scenes; lawn lamps can be a variety of heights at the same time the lighting effect will be different, more to provide a choice.

## Lightmap (光影图)

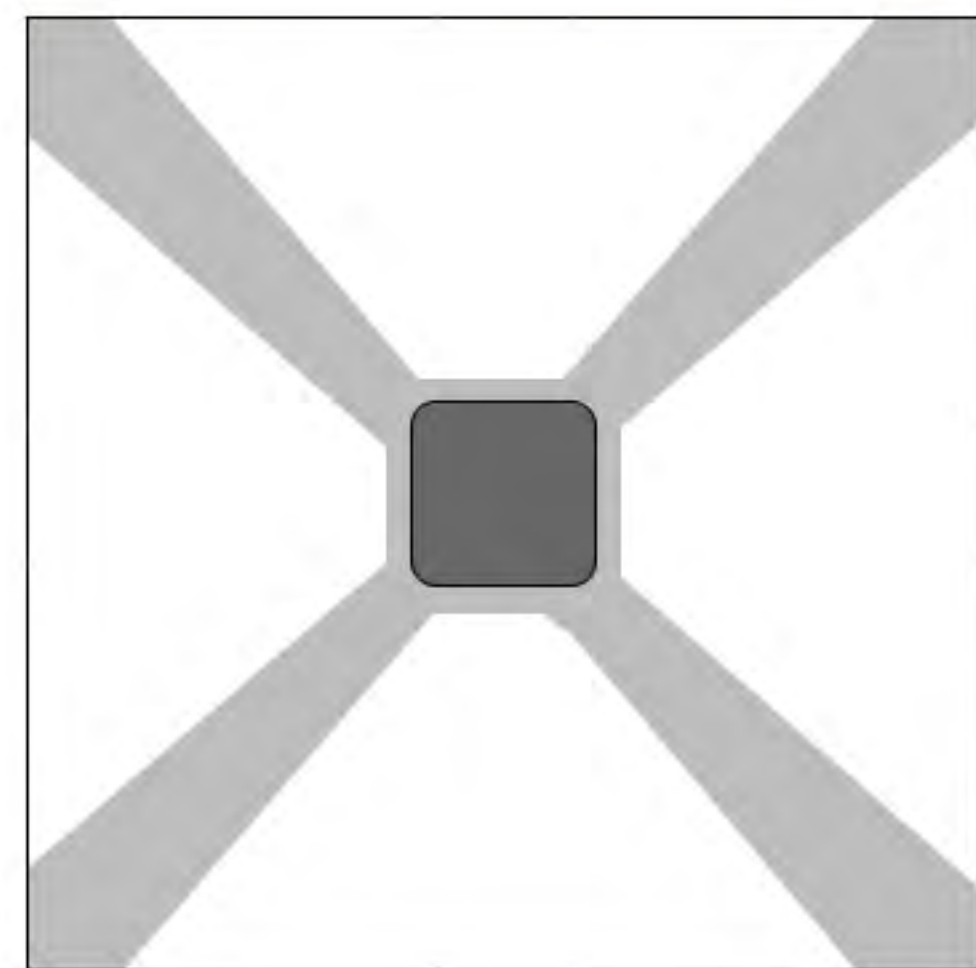

top view (俯视图)

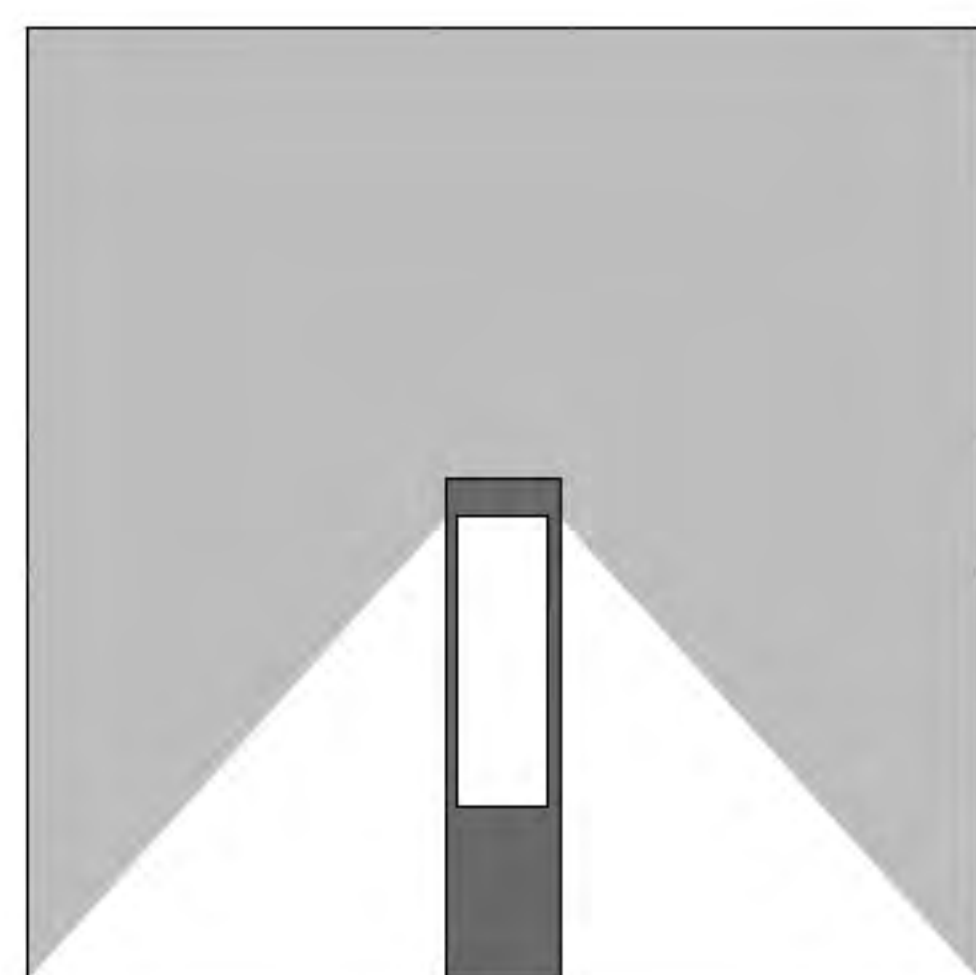

front view (正面图)

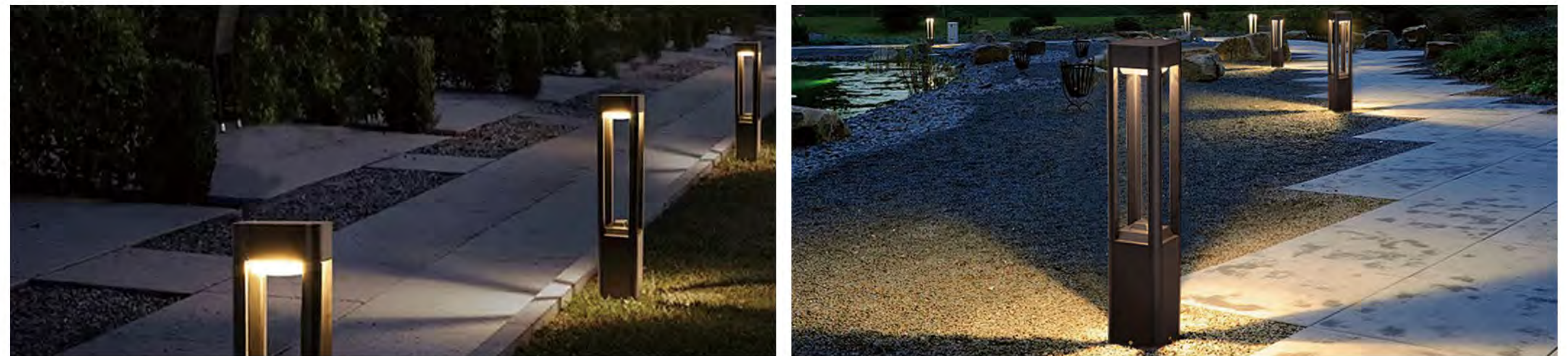

## Technical Date (技术参数)

Item No.	Lamp Type	Power	LM	CCT	PF	Voltage	CRI	A	B	C (mm)
MB19-C002A	LED	10W	700	2700K-6000K	0.6	AC110-265V	80-90	120	400	600
MB19-C002B	LED	10W	700	2700K-6000K	0.6	AC110-265V	80-90	120	700	900



# MB19-C002-SL

# SOLAR LIGHT

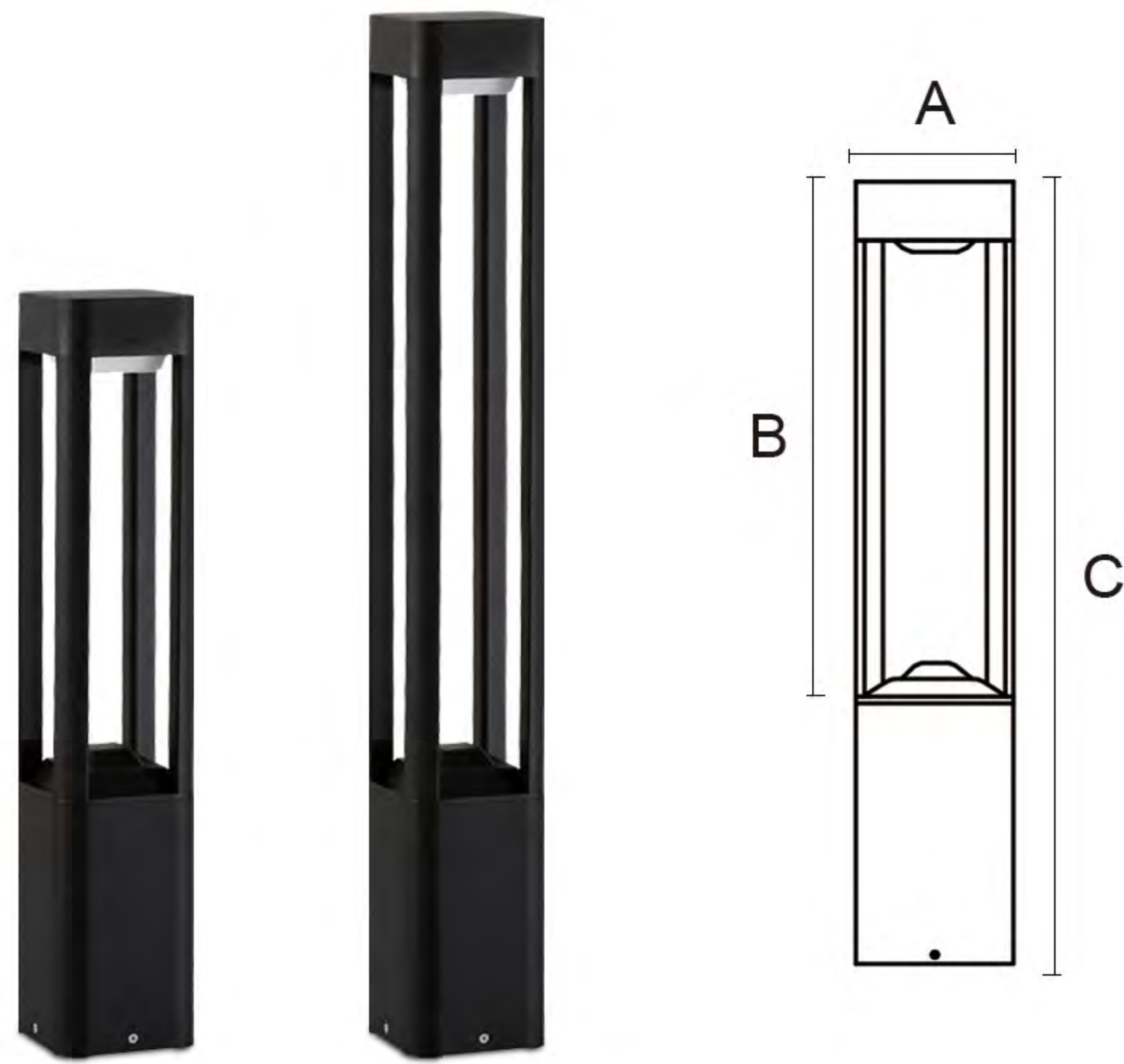

## Features&Benefit (功能和优点)

Category (品类)	Garden Light
Diffuser Material (扩散器材质)	PC
Cover Material (面盖材质)	Aluminum+Solar Panel
Operating mode (运行)	Built in
Steuerbar (开关)	On/Off
Working Hours (工作时长)	8 Hours
IP (防水等级)	54
Mounting type (安装类型)	Put
Mounting location (安装位置)	Overground
Application environment (应用环境)	Indoor/Outdoor
Body color (表面颜色)	Black/Dark Gray/Sliver Gray



## Product Description (产品描述)

Suitable for parks and gardens, neighborhoods, villas, city squares, pedestrian streets, scenic spots or resorts and other various scenes; lawn lamps can be a variety of heights at the same time the lighting effect will be different, more to provide a choice.



Solar Panel



No/Off

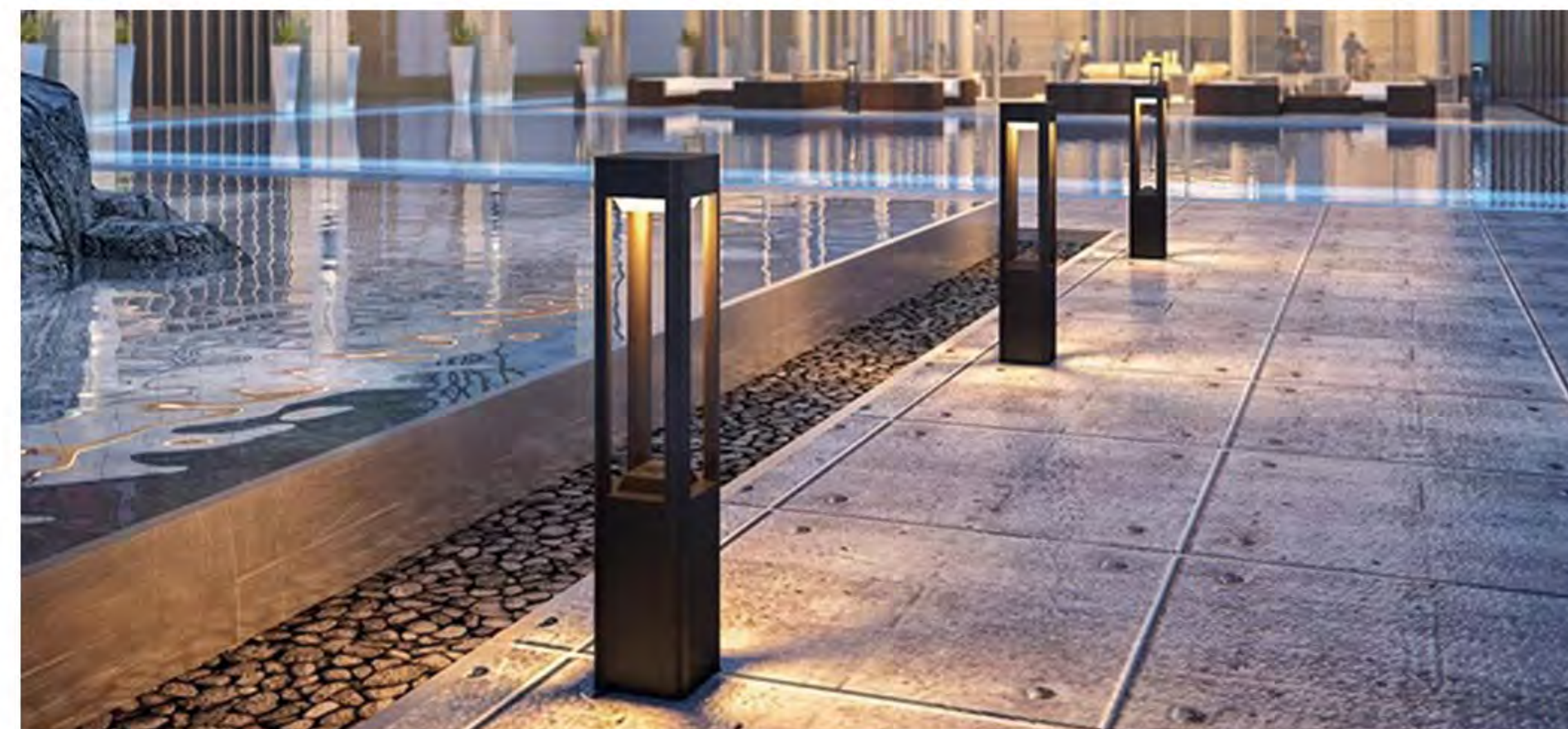

## Technical Date (技术参数)

Item No.	Lamp Type	Power	LM	CCT	CRI	A	B	C (mm)
MB19-C002A-SL	LED	3W	210	2700K-6000K	80-90	120	400	600
MB19-C002B-SL	LED	3W	210	2700K-6000K	80-90	120	700	900



# MB19-C003

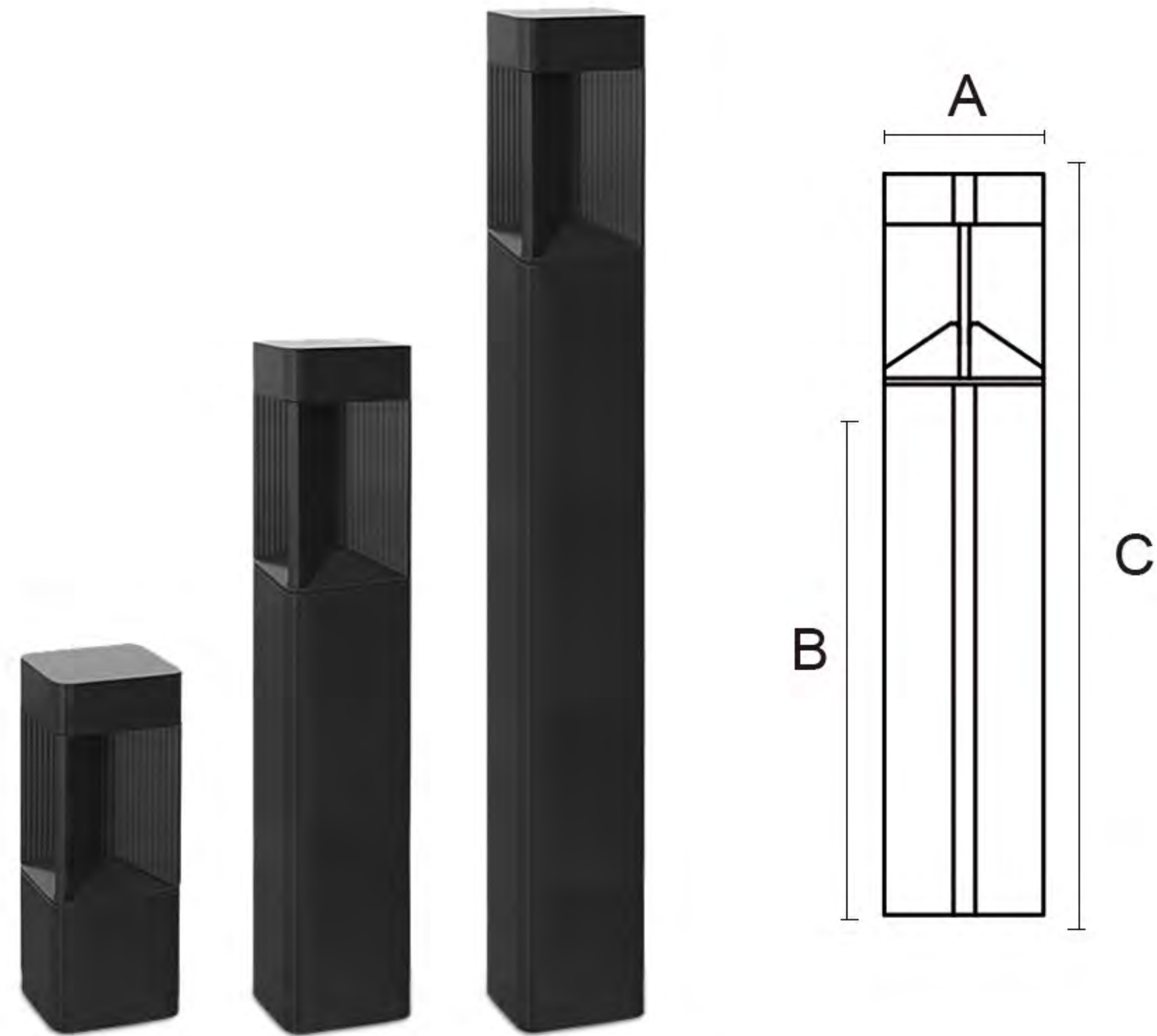

## Features&Benefit (功能和优点)

Category (品类)	Garden Light
Diffuser Material (扩散器材质)	PC
Cover Material (面盖材质)	Aluminum
Operating mode (运行)	Built in
Steuerbar (开关)	On/Off
IP (防水等级)	54
Mounting type (安装类型)	Put
Mounting location (安装位置)	Overground
Application environment (应用环境)	Indoor/Outdoor
Body color (表面颜色)	Black/Dark Gray/Sliver Gray



## Product Description (产品描述)

Suitable for parks and gardens, neighborhoods, villas, city squares, pedestrian streets, scenic spots or resorts and other various scenes; lawn lamps can be a variety of heights at the same time the lighting effect will be different, more to provide a choice.

## Lightmap (光影图)

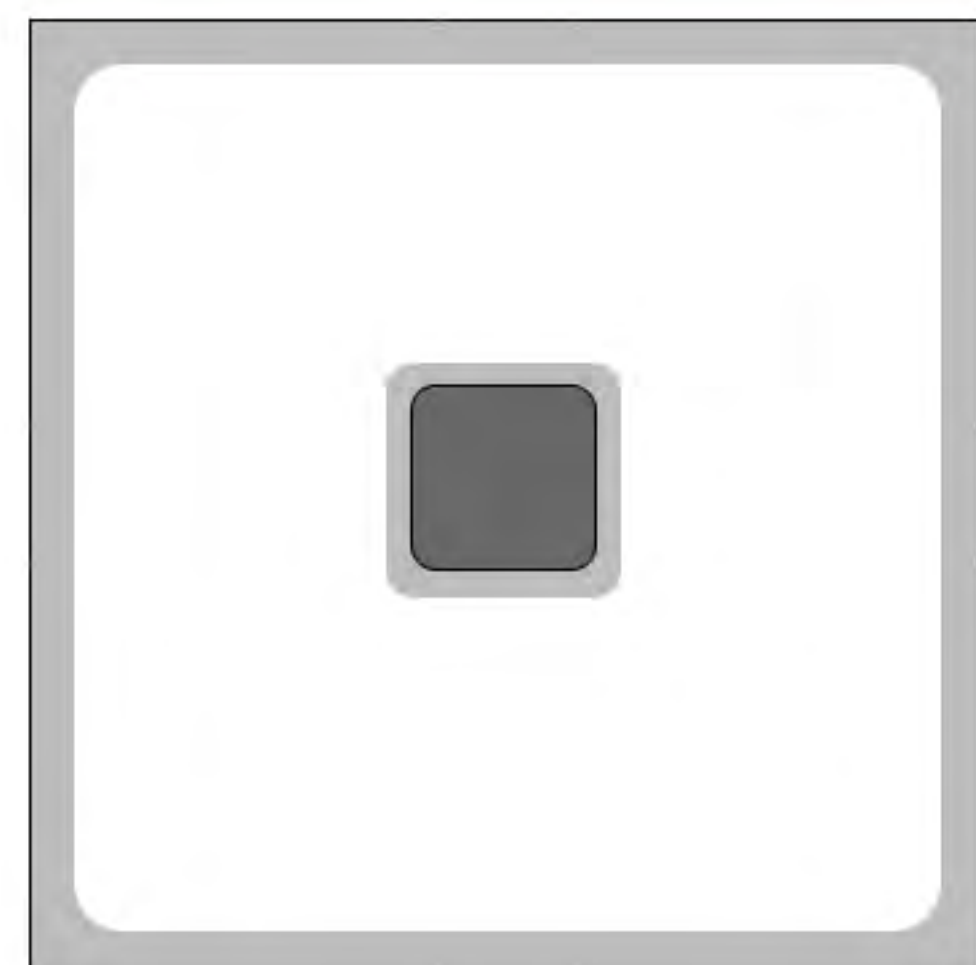

top view (俯视图)

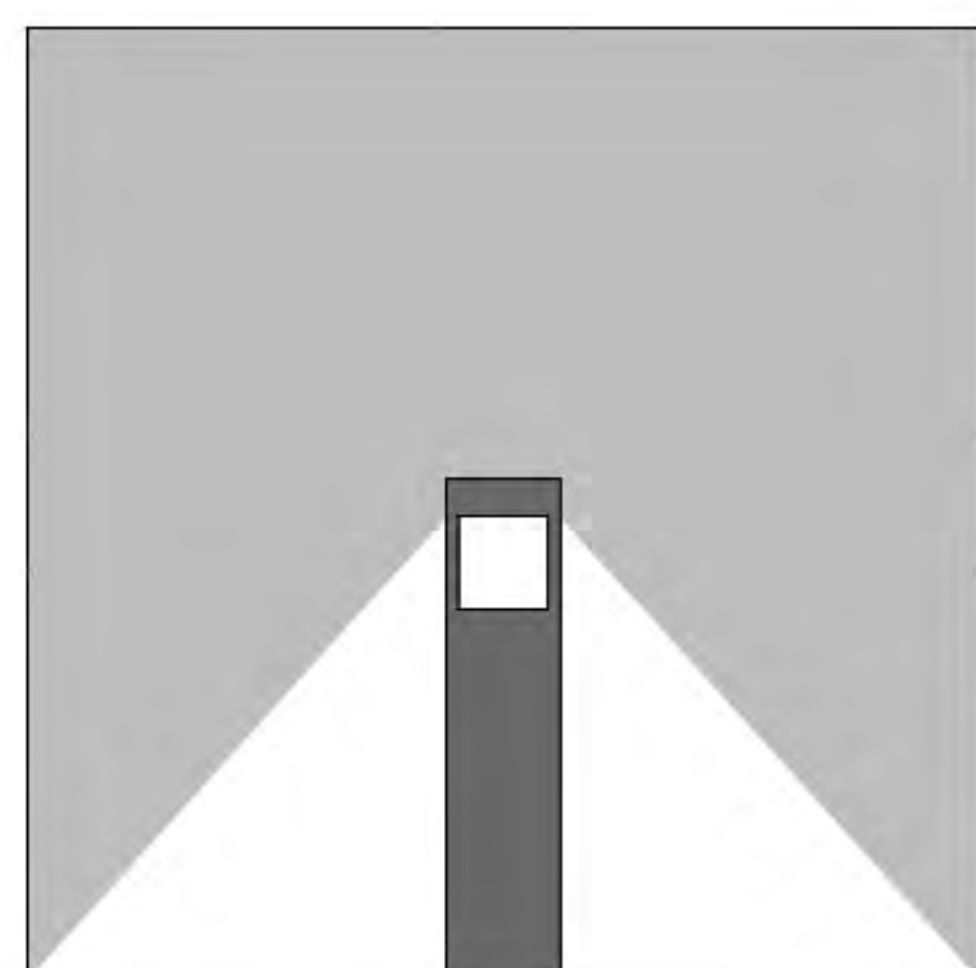

front view (正面图)



## Technical Date (技术参数)

Item No.	Lamp Type	Power	LM	CCT	PF	Voltage	CRI	A	B	C (mm)
MB19-C003A	LED	10W	700	2700K-6000K	0.6	AC110-265V	80-90	120	100	300
MB19-C003B	LED	10W	700	2700K-6000K	0.6	AC110-265V	80-90	120	400	600
MB19-C003C	LED	10W	700	2700K-6000K	0.6	AC110-265V	80-90	120	700	900



# MB19-C004

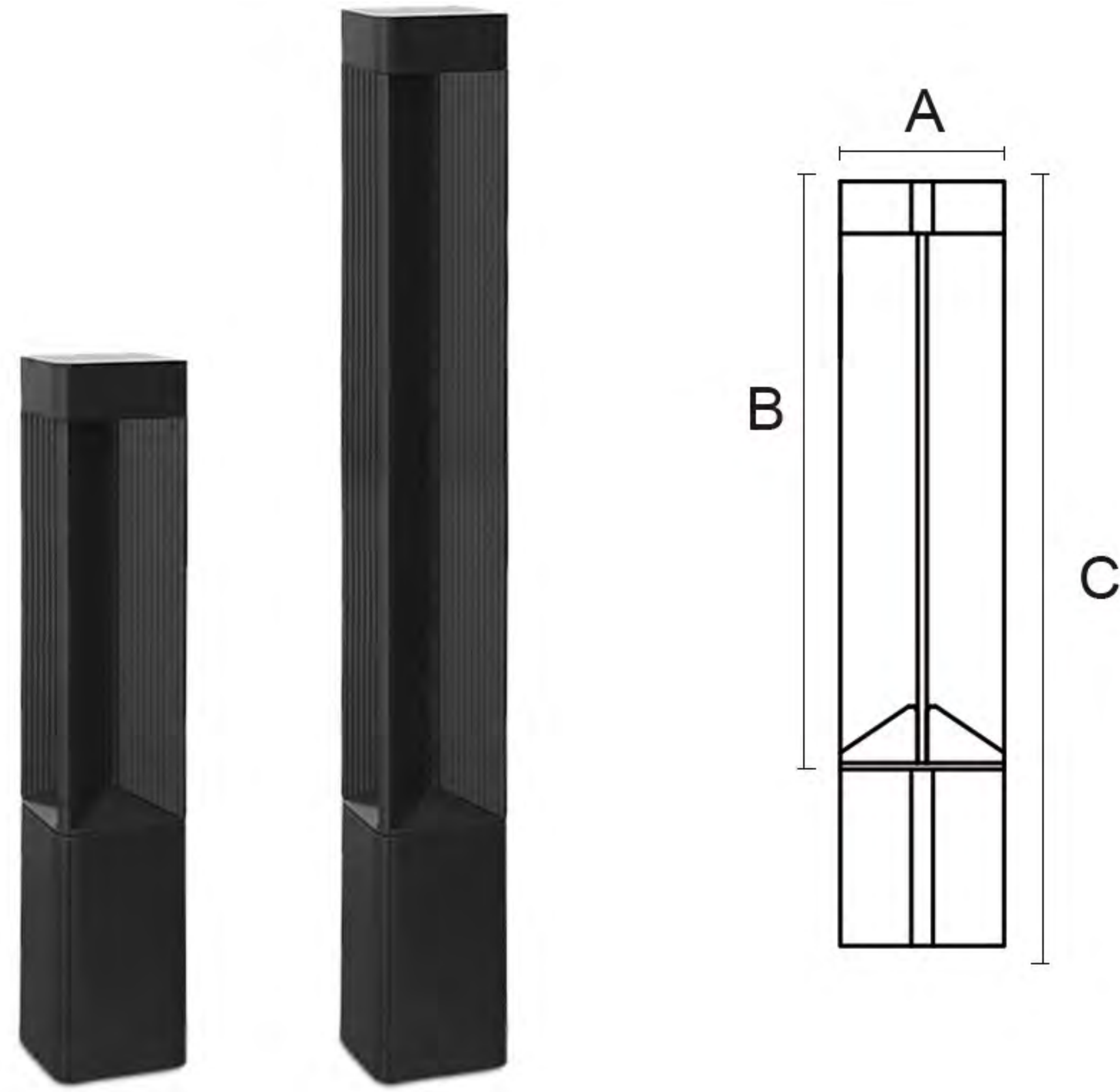

## Features&Benefit (功能和优点)

Category (品类)	Garden Light
Diffuser Material (扩散器材质)	PC
Cover Material (面盖材质)	Aluminum
Operating mode (运行)	Built in
Steuerbar (开关)	On/Off
IP (防水等级)	54
Mounting type (安装类型)	Put
Mounting location (安装位置)	Overground
Application environment (应用环境)	Indoor/Outdoor
Body color (表面颜色)	Black/Dark Gray/Sliver Gray



## Product Description (产品描述)

Suitable for parks and gardens, neighborhoods, villas, city squares, pedestrian streets, scenic spots or resorts and other various scenes; lawn lamps can be a variety of heights at the same time the lighting effect will be different, more to provide a choice.

## Lightmap (光影图)

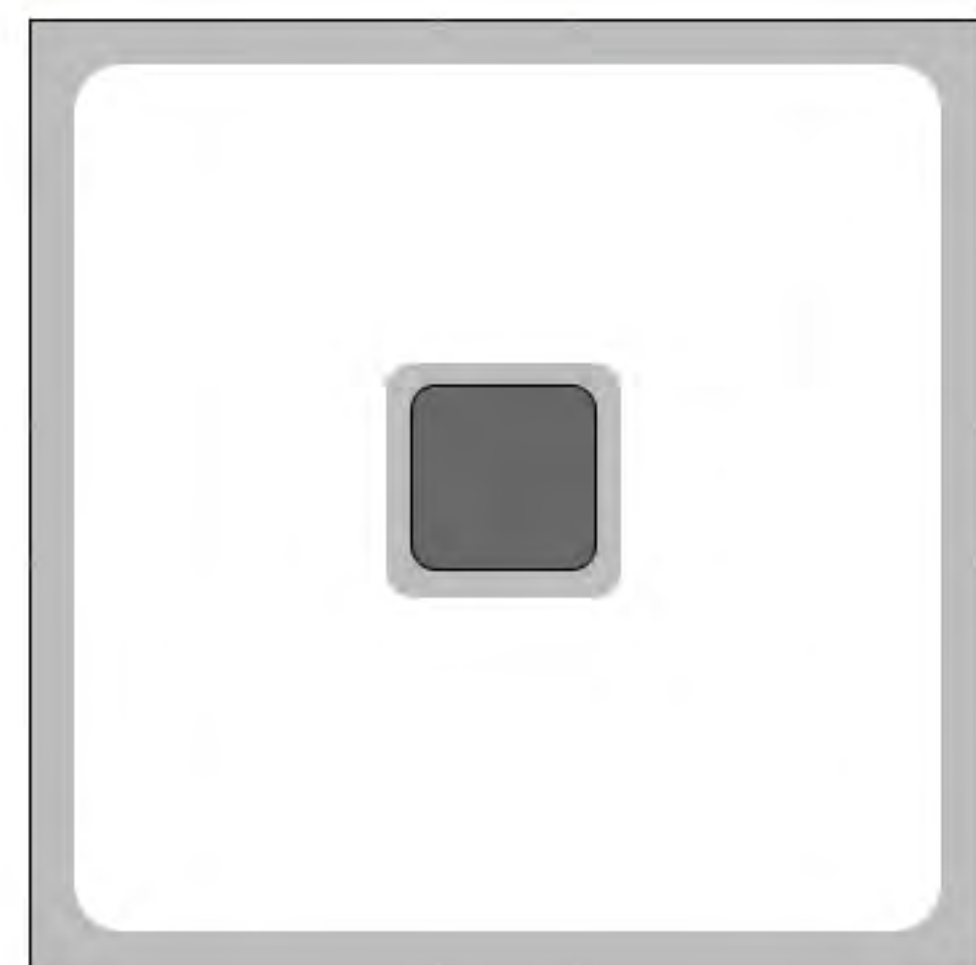

top view (俯视图)

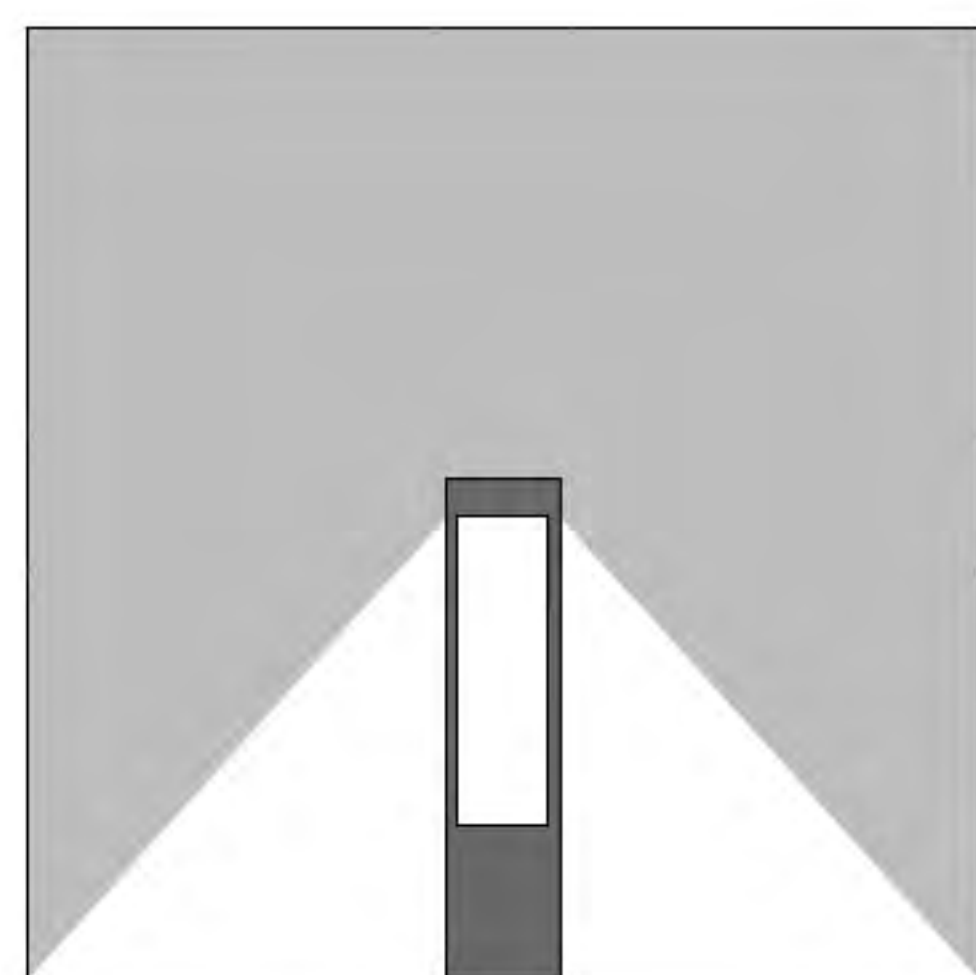

front view (正面图)

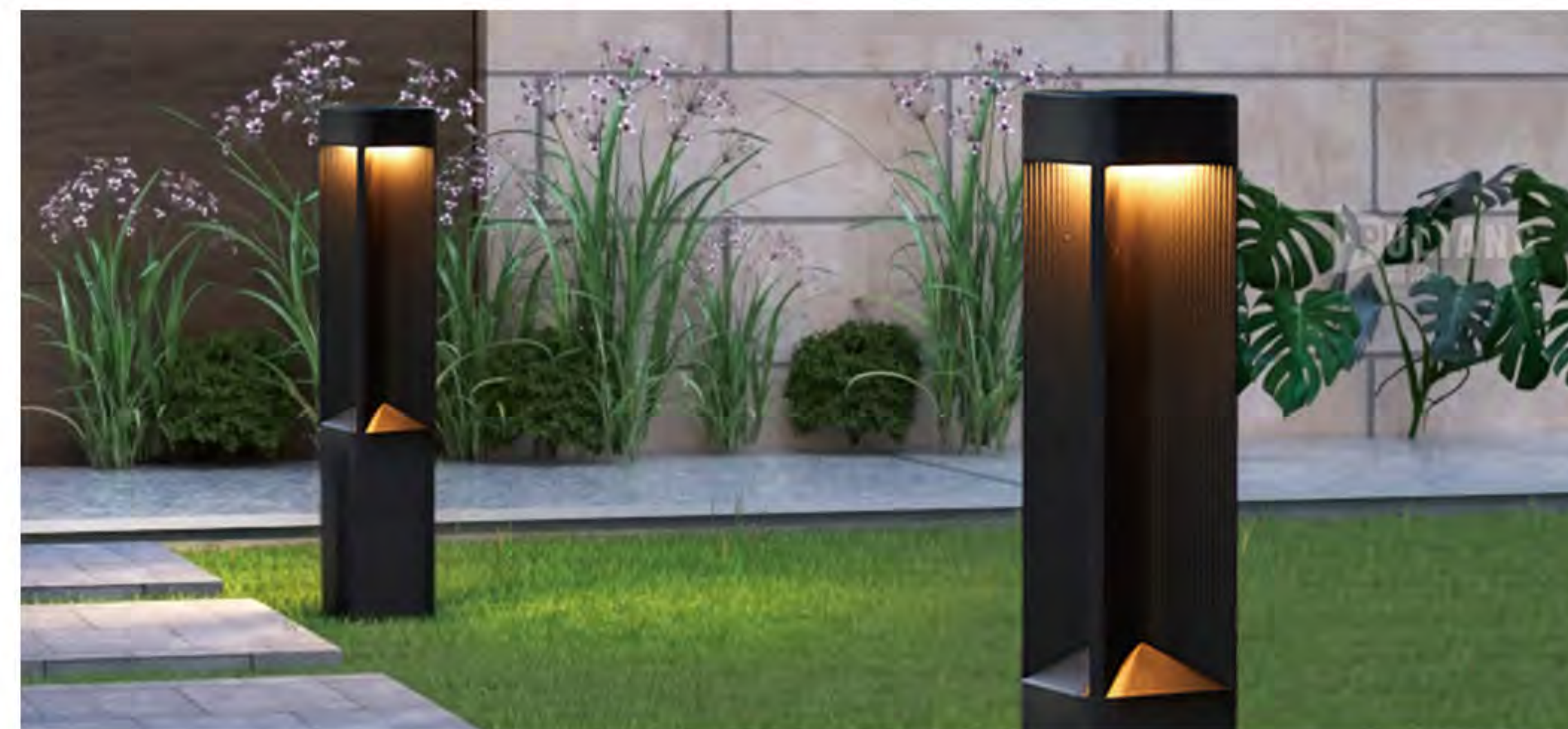

## Technical Date (技术参数)

Item No.	Lamp Type	Power	LM	CCT	PF	Voltage	CRI	A	B	C (mm)
MB19-C004A	LED	10W	700	2700K-6000K	0.6	AC110-265V	80-90	120	400	600
MB19-C004B	LED	10W	700	2700K-6000K	0.6	AC110-265V	80-90	120	700	900



# MB19-C005

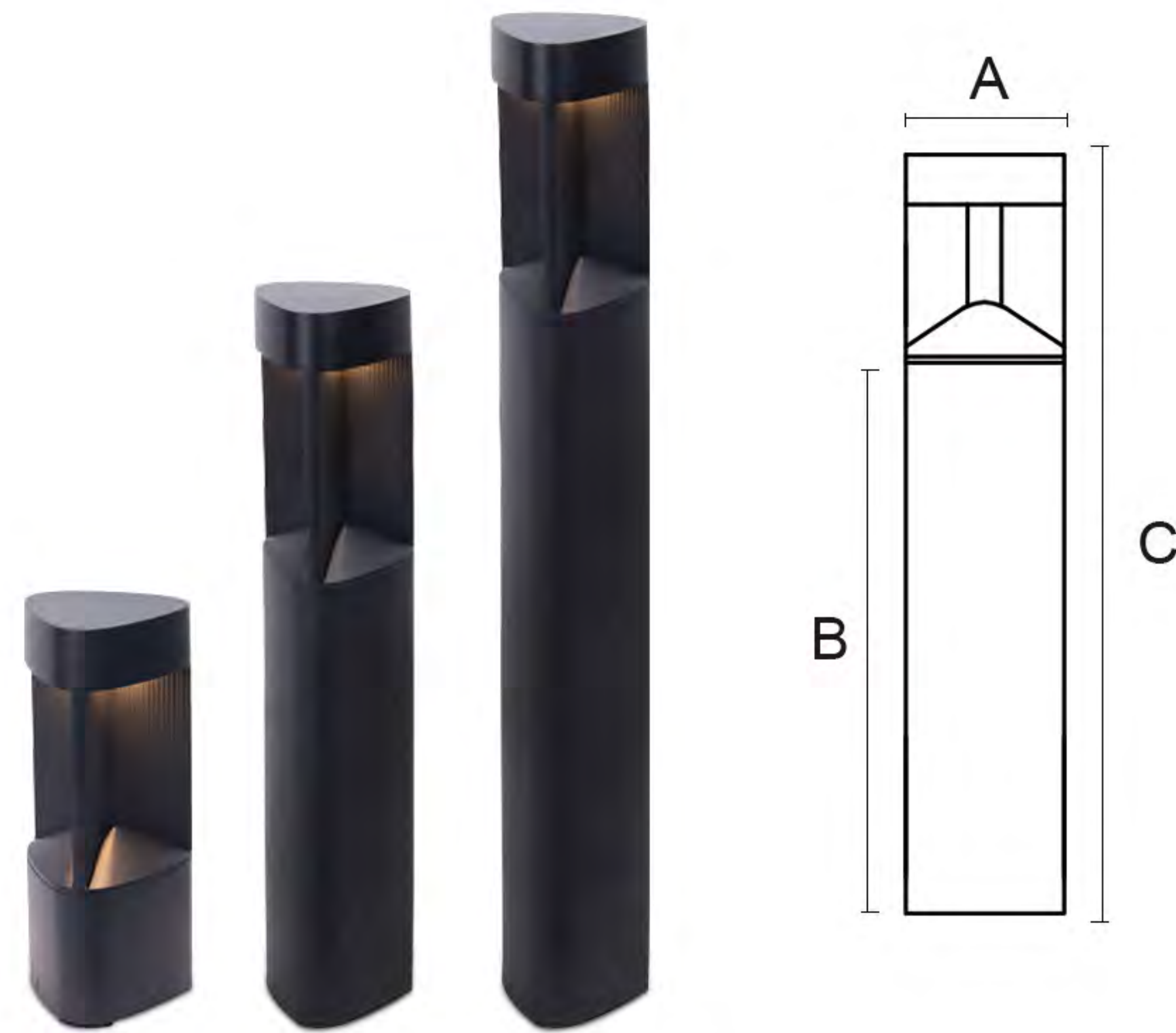

## Features&Benefit (功能和优点)

Category (品类)	Garden Light
Diffuser Material (扩散器材质)	PC
Cover Material (面盖材质)	Aluminum
Operating mode (运行)	Built in
Steuerbar (开关)	On/Off
IP (防水等级)	54
Mounting type (安装类型)	Put
Mounting location (安装位置)	Overground
Application environment (应用环境)	Indoor/Outdoor
Body color (表面颜色)	Black/Dark Gray/Sliver Gray



## Product Description (产品描述)

Suitable for parks and gardens, neighborhoods, villas, city squares, pedestrian streets, scenic spots or resorts and other various scenes; lawn lamps can be a variety of heights at the same time the lighting effect will be different, more to provide a choice.

## Lightmap (光影图)

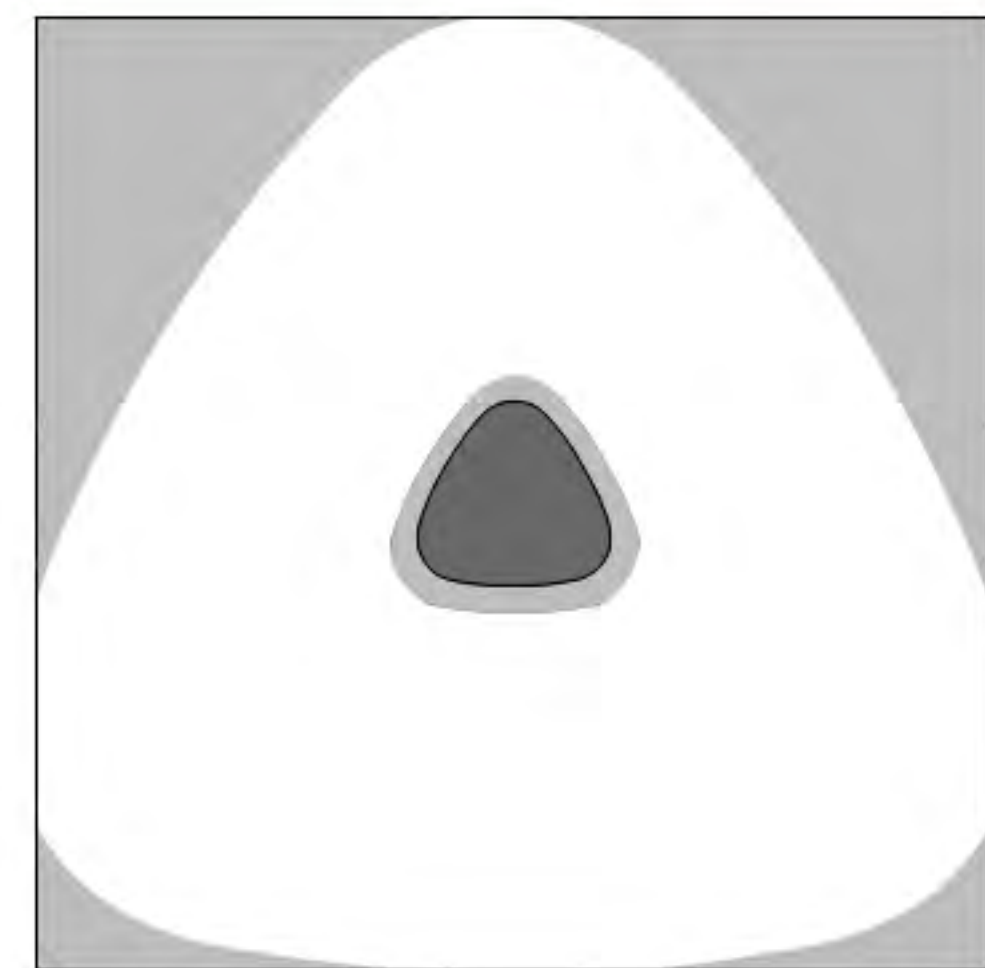

top view (俯视图)

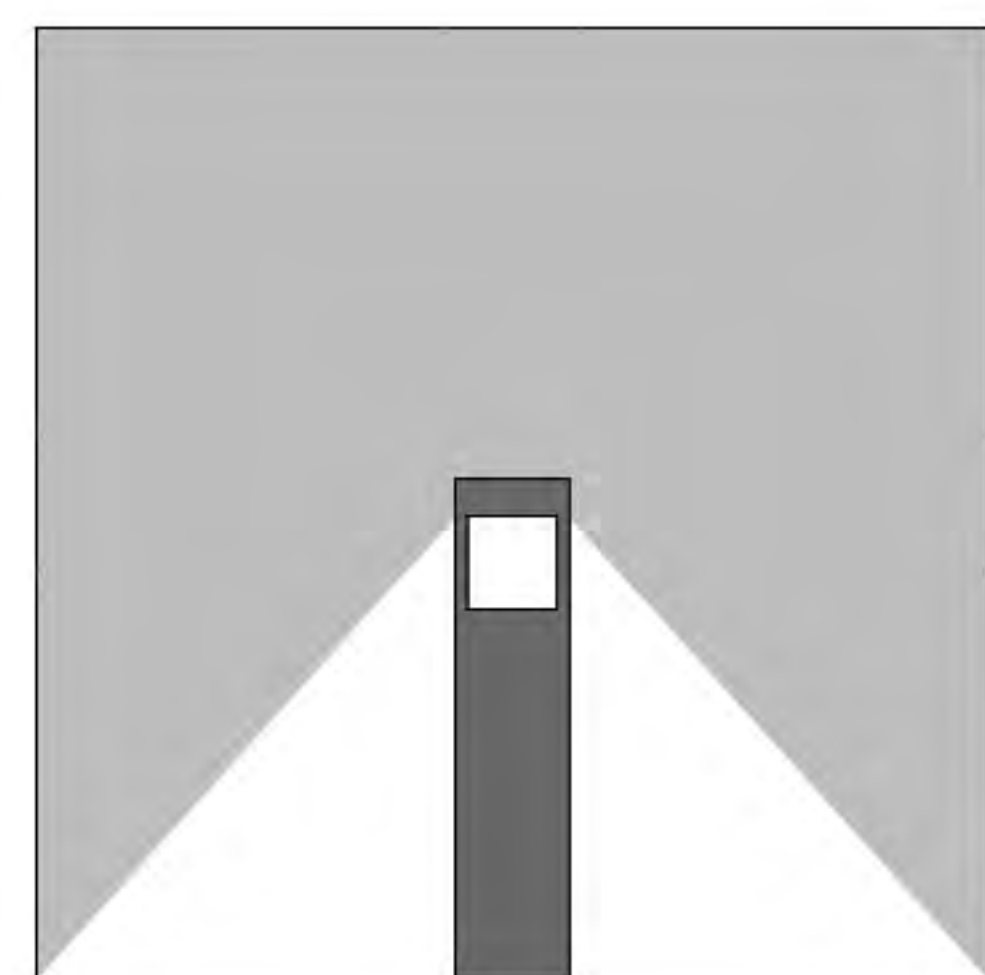

front view (正面图)



## Technical Date (技术参数)

Item No.	Lamp Type	Power	LM	CCT	PF	Voltage	CRI	A	B	C (mm)
MB19-C005A	LED	10W	700	2700K-6000K	0.6	AC110-265V	80-90	125	100	300
MB19-C005B	LED	10W	700	2700K-6000K	0.6	AC110-265V	80-90	125	400	600
MB19-C005C	LED	10W	700	2700K-6000K	0.6	AC110-265V	80-90	125	700	900



# MB19-C006

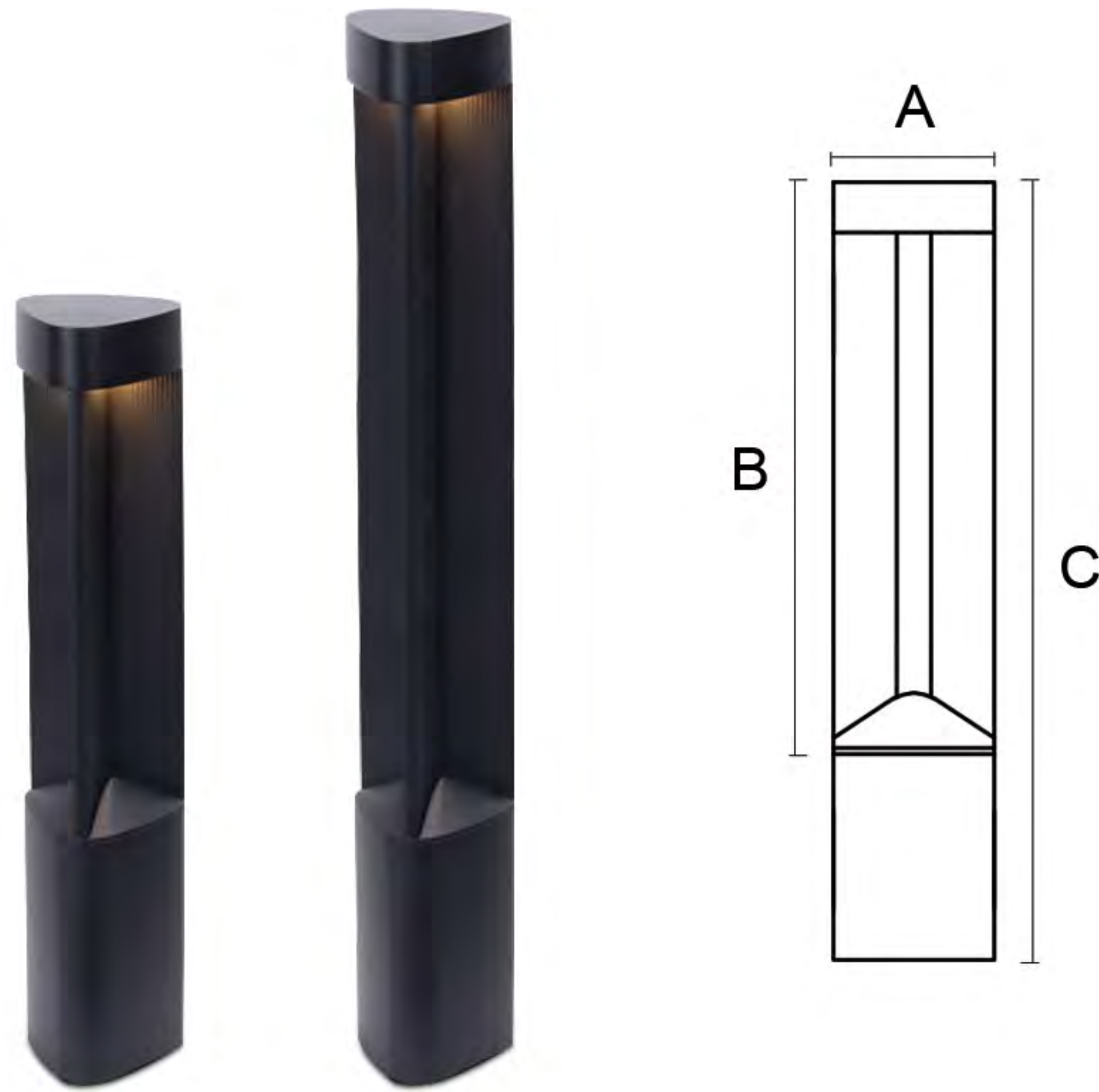

## Features&Benefit (功能和优点)

Category (品类)	Garden Light
Diffuser Material (扩散器材质)	PC
Cover Material (面盖材质)	Aluminum
Operating mode (运行)	Built in
Steuerbar (开关)	On/Off
IP (防水等级)	54
Mounting type (安装类型)	Put
Mounting location (安装位置)	Overground
Application environment (应用环境)	Indoor/Outdoor
Body color (表面颜色)	Black/Dark Gray/Sliver Gray



## Product Description (产品描述)

Suitable for parks and gardens, neighborhoods, villas, city squares, pedestrian streets, scenic spots or resorts and other various scenes; lawn lamps can be a variety of heights at the same time the lighting effect will be different, more to provide a choice.

## Lightmap (光影图)

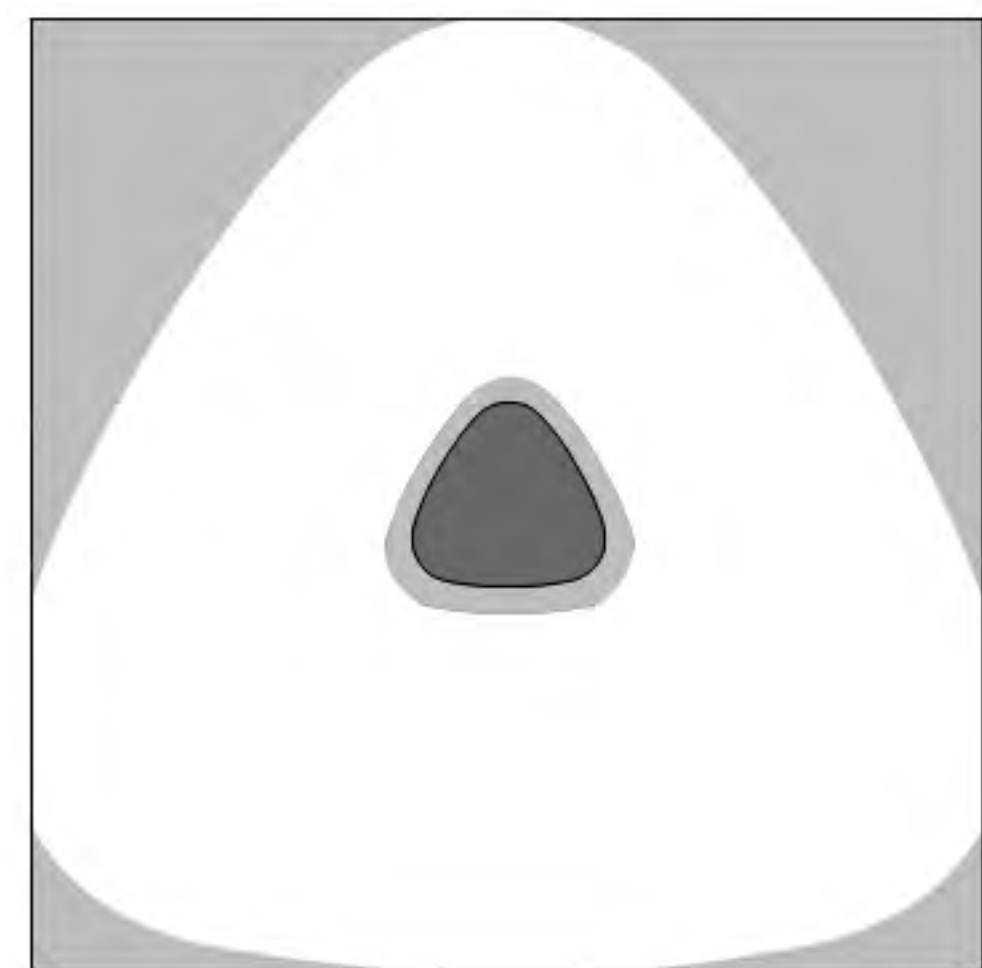

top view (俯视图)

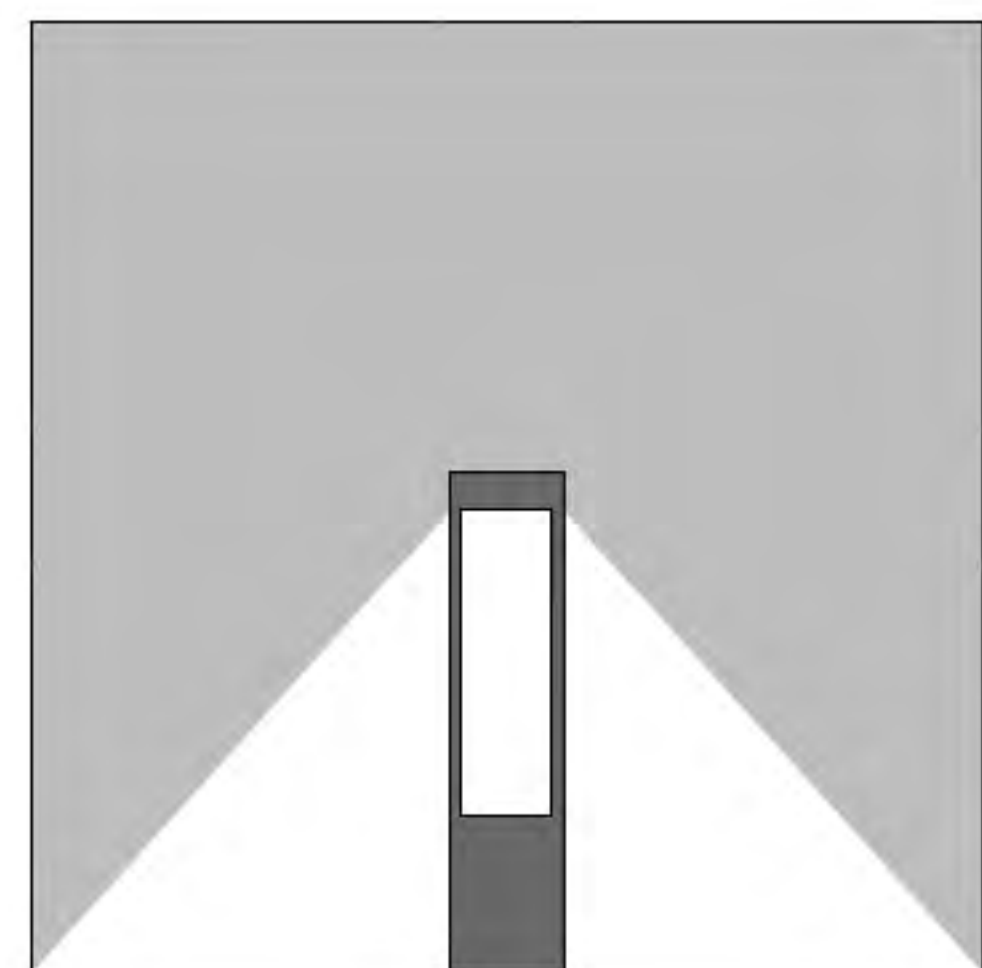

front view (正面图)



## Technical Date (技术参数)

Item No.	Lamp Type	Power	LM	CCT	PF	Voltage	CRI	A	B	C (mm)
MB19-C006A	LED	10W	700	2700K-6000K	0.6	AC110-265V	80-90	120	400	600
MB19-C006B	LED	10W	700	2700K-6000K	0.6	AC110-265V	80-90	120	700	900



# MB19-C013



## Features&Benefit (功能和优点)

Category (品类)	Garden Light
Diffuser Material (扩散器材质)	PC
Cover Material (面盖材质)	Aluminum
Operating mode (运行)	Built in
Steuerbar (开关)	On/Off
IP (防水等级)	54
Mounting type (安装类型)	Put
Mounting location (安装位置)	Overground
Application environment (应用环境)	Indoor/Outdoor
Body color (表面颜色)	Black/Dark Gray/Sliver Gray



## Product Description (产品描述)

Suitable for urban slow lane, narrow lanes, residential neighborhoods, tourist attractions, parks, squares, private gardens, courtyard corridors and other public places of the road on one side or both sides of the road lighting; unique design, soft light, so that the scene is full of layers.

## Lightmap (光影图)



top view (俯视图)

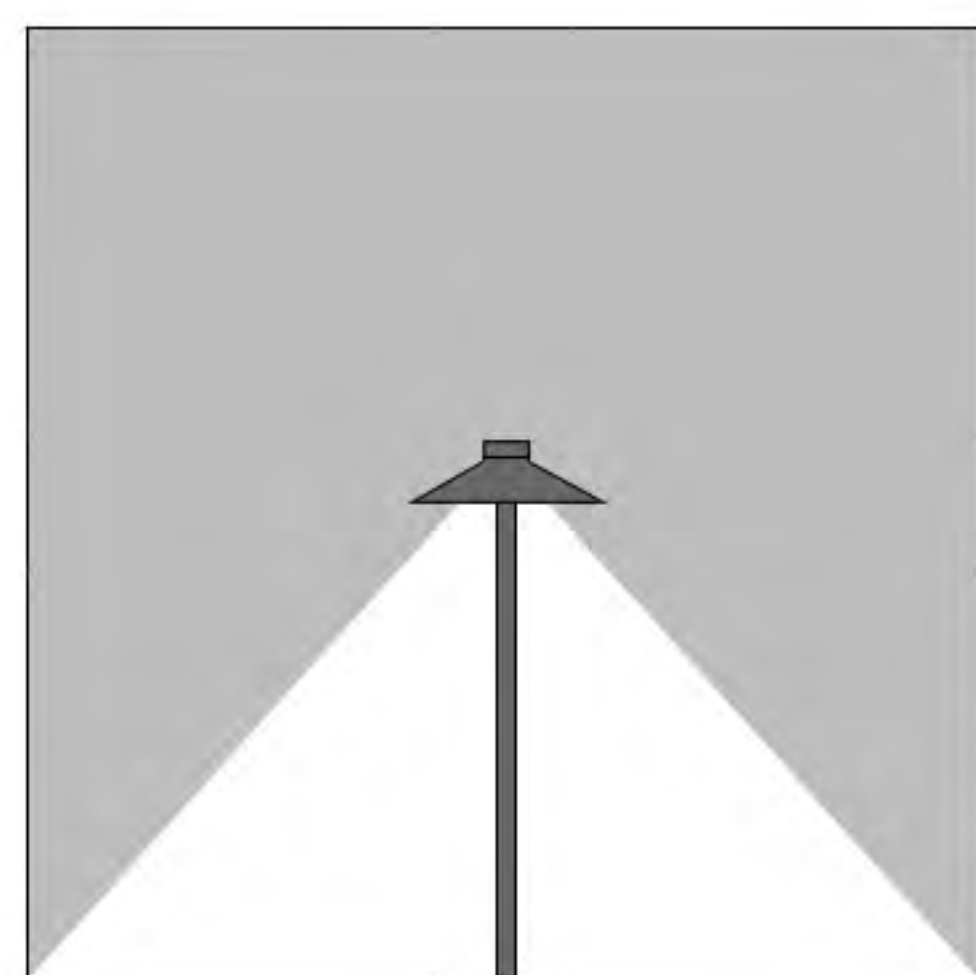

front view (正面图)

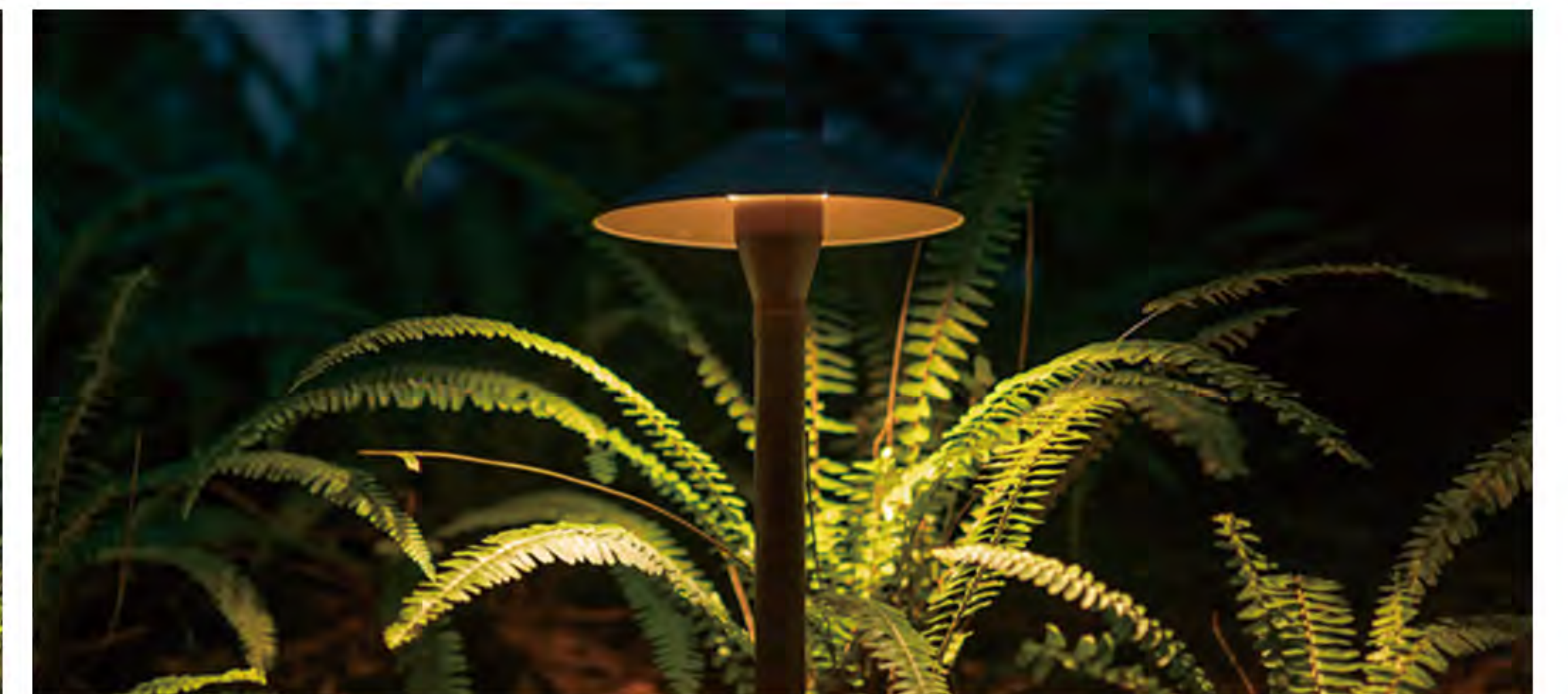

## Technical Date (技术参数)

Item No.	Lamp Type	Power	LM	CCT	PF	Voltage	CRI	A	B	C (mm)
MB19-C013	LED	7W	490	2700K-6000K	0.6	AC110-265V	80-90	Ø200	Ø100	539
MB19-C013	LED	5W	350	2700K-6000K	0.6	DC12/24V	80-90	Ø200	Ø100	539





# MB19-C014

## Features&Benefit (功能和优点)

Category (品类)	Garden Light
Diffuser Material (扩散器材质)	PC
Cover Material (面盖材质)	Aluminum
Operating mode (运行)	Built in
Steuerbar (开关)	On/Off
IP (防水等级)	54
Mounting type (安装类型)	Insert
Mounting location (安装位置)	Underground
Application environment (应用环境)	Indoor/Outdoor
Body color (表面颜色)	Black/Dark Gray/Sliver Gray



## Product Description (产品描述)

Suitable for urban slow lane, narrow lanes, residential neighborhoods, tourist attractions, parks, squares, private gardens, courtyard corridors and other public places of the road on one side or both sides of the road lighting; unique design, soft light, so that the scene is full of layers.

## Lightmap (光影图)



top view (俯视图)

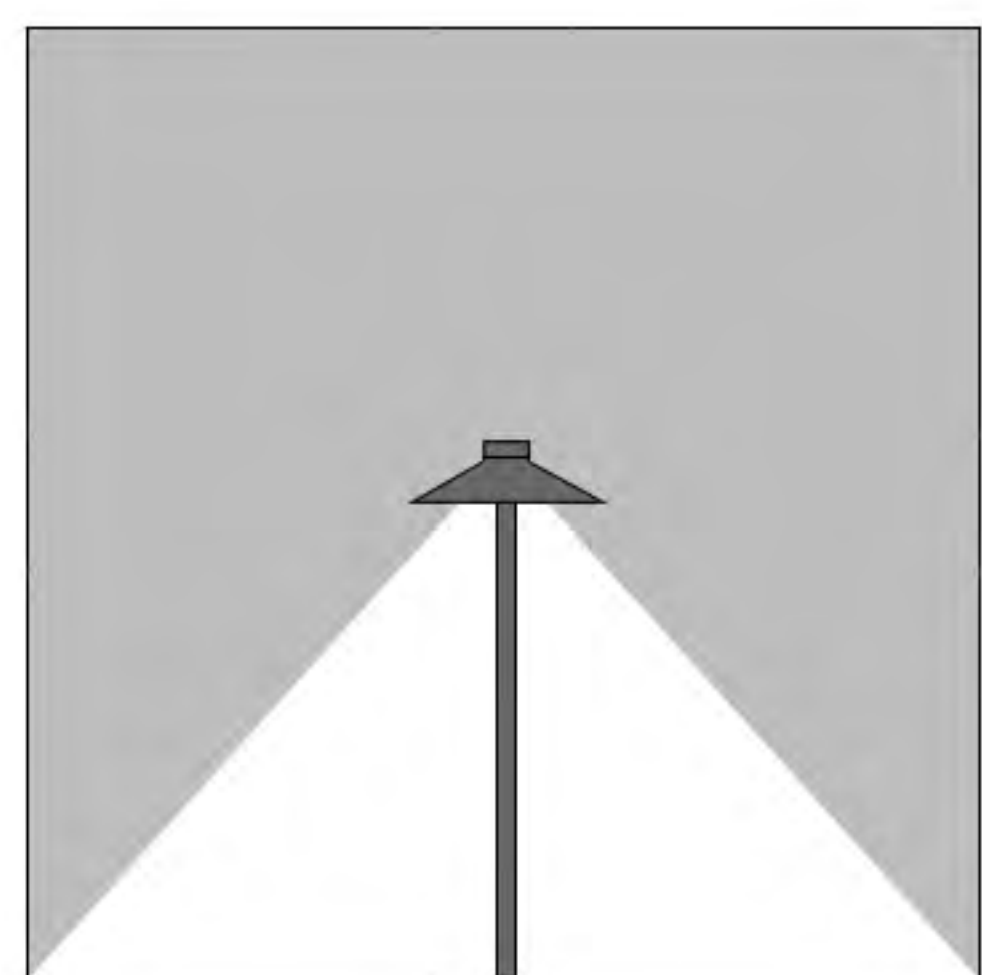

front view (正面图)



## Technical Date (技术参数)

Item No.	Lamp Type	Power	LM	CCT	PF	Voltage	CRI	A	B	C (mm)
MB19-C014	LED	7W	490	2700K-6000K	0.6	AC110-265V	80-90	Ø200	702	-
MB19-C014	LED	5W	350	2700K-6000K	0.6	DC12/24V	80-90	Ø200	702	-



# MB18-C015

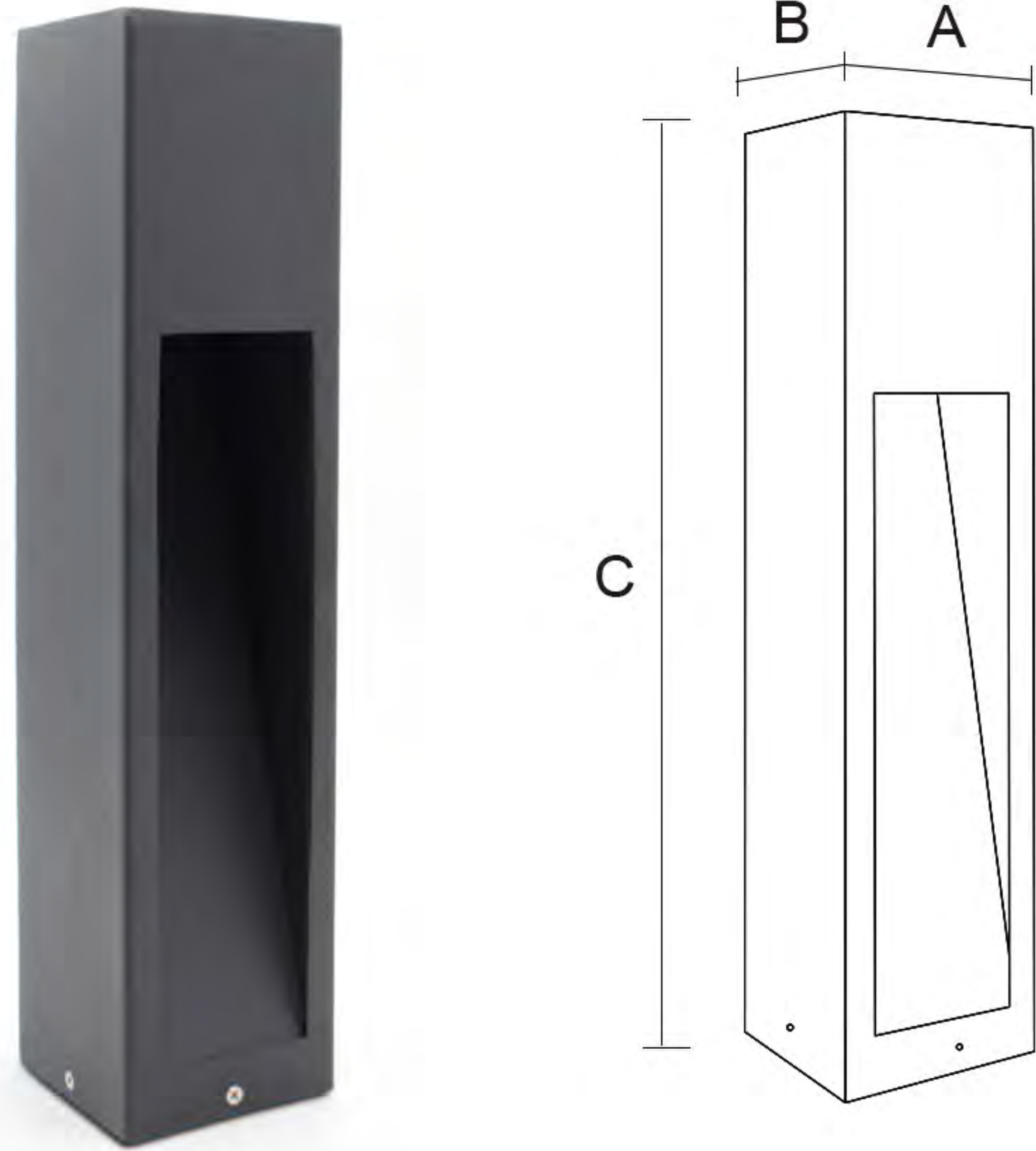

## Features&Benefit (功能和优点)

Category (品类)	Garden Light
Diffuser Material (扩散器材质)	Glass
Cover Material (面盖材质)	Aluminum
Operating made (运行)	Built in
Steuerbar (开关)	On/Off
IP (防水等级)	54
Mounting type (安装类型)	Put
Mounting location (安装位置)	Overground
Application environment (应用环境)	Indoor/Outdoor
Body color (表面颜色)	Black/Dark Gray/Sliver Gray



## Product Description (产品描述)

Suitable for urban slow lane, narrow lanes, residential neighborhoods, tourist attractions, parks, squares, private gardens, courtyard corridors and other public places of the road on one side or both sides of the road lighting; unique design, soft light, so that the scene is full of layers.

## Lightmap (光影图)

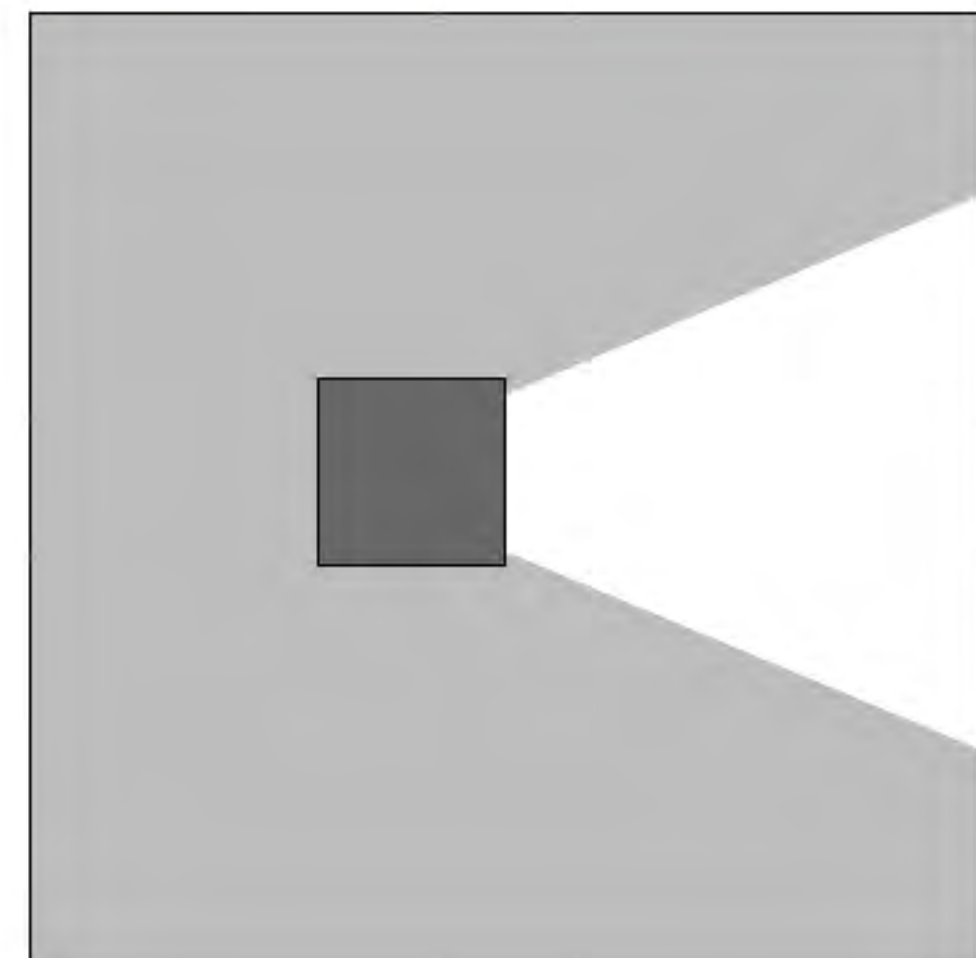

top view (俯视图)

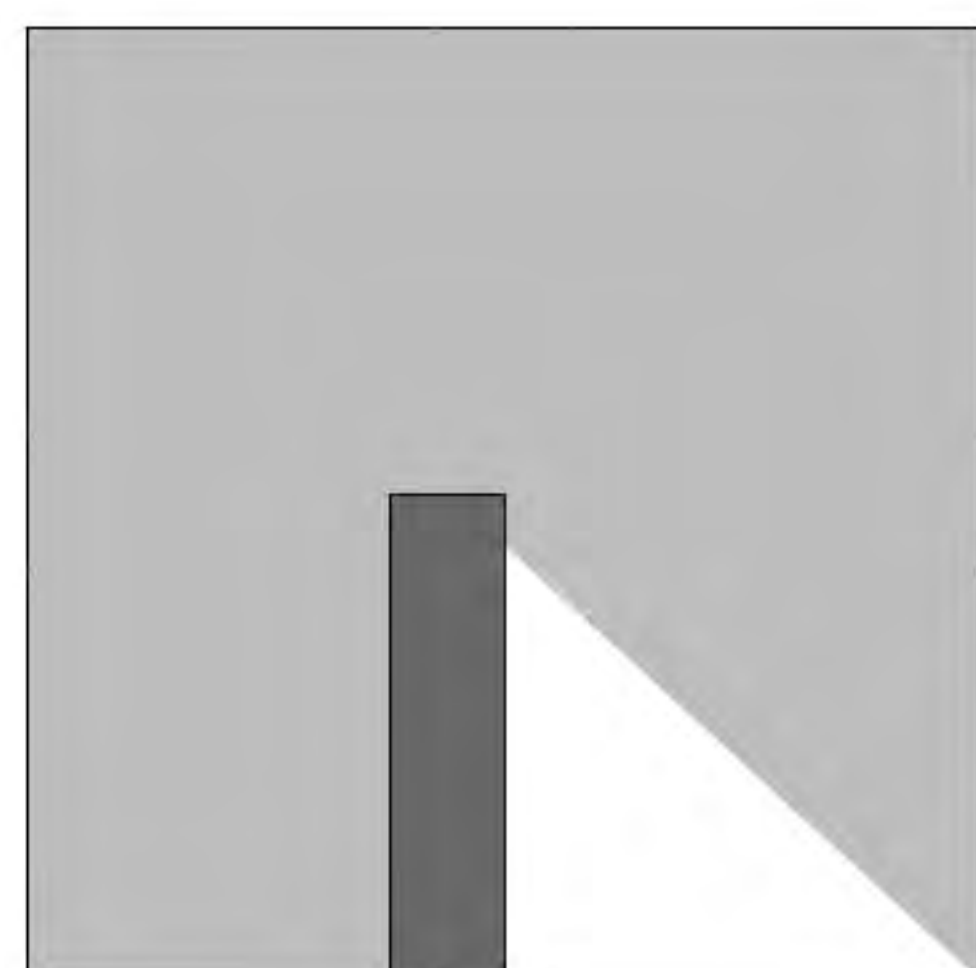

front view (正面图)



## Technical Date (技术参数)

Item No.	Lamp Type	Power	LM	CCT	PF	Voltage	CRI	A	B	C (mm)
MB19-C015A	LED	10W	700	2700K-6000K	0.6	AC110-265V	80-90	120	120	600
MB19-C015B	LED	10W	700	2700K-6000K	0.6	AC110-265V	80-90	150	150	600



# MB21-BL01

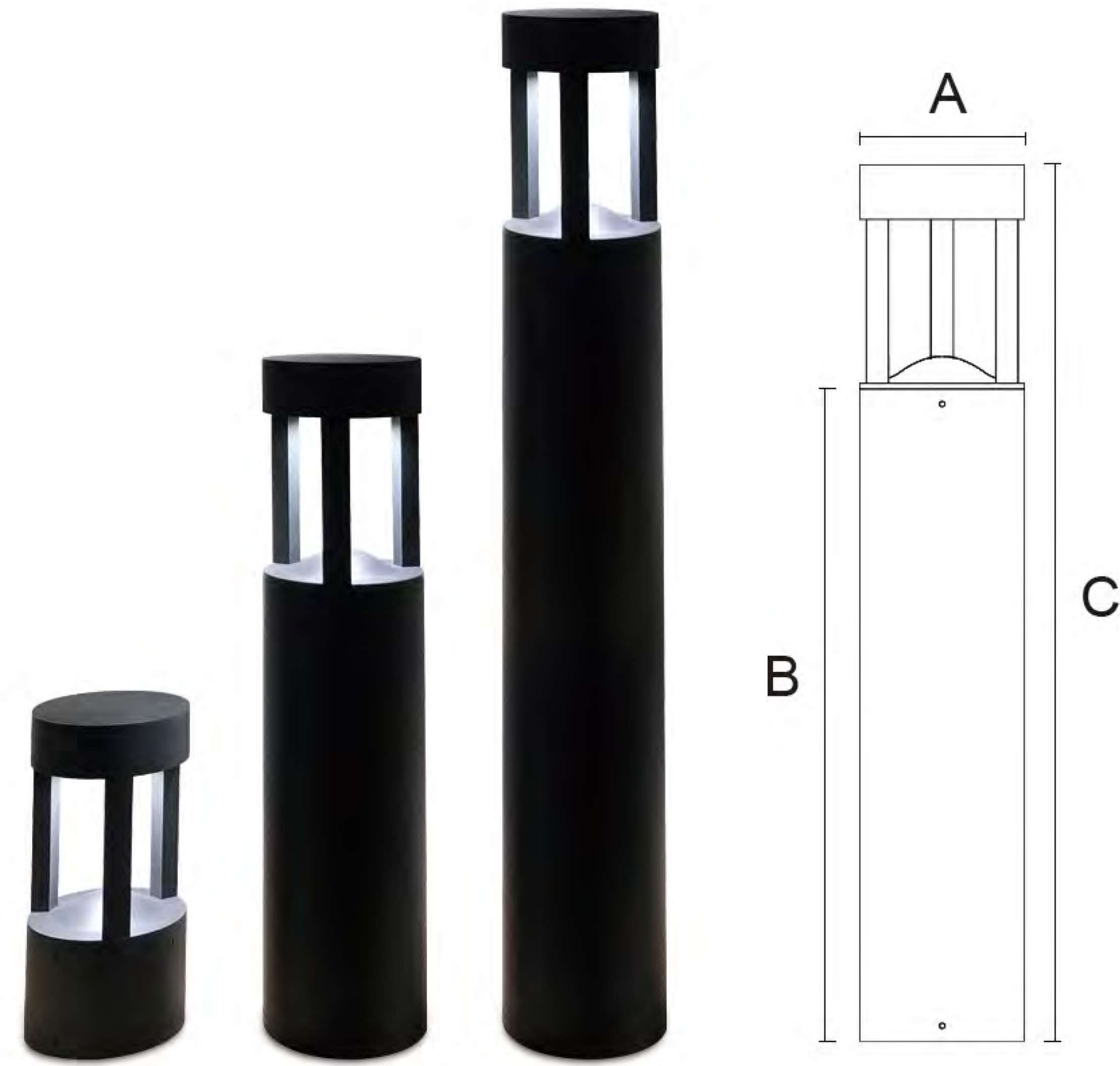

## Features&Benefit (功能和优点)

Category (品类)	Garden Light
Diffuser Material (扩散器材质)	Glass
Cover Material (面盖材质)	Aluminum
Operating mode (运行)	Built in
Steuerbar (开关)	On/Off
IP (防水等级)	54
Mounting type (安装类型)	Put
Mounting location (安装位置)	Overground
Application environment (应用环境)	Indoor/Outdoor
Body color (表面颜色)	Black/Dark Gray/Sliver Gray



## Product Description (产品描述)

Suitable for parks and gardens, neighborhoods, villas, city squares, pedestrian streets, scenic spots or resorts and other various scenes; lawn lamps can be a variety of heights at the same time the lighting effect will be different, more to provide a choice.

## Lightmap (光影图)

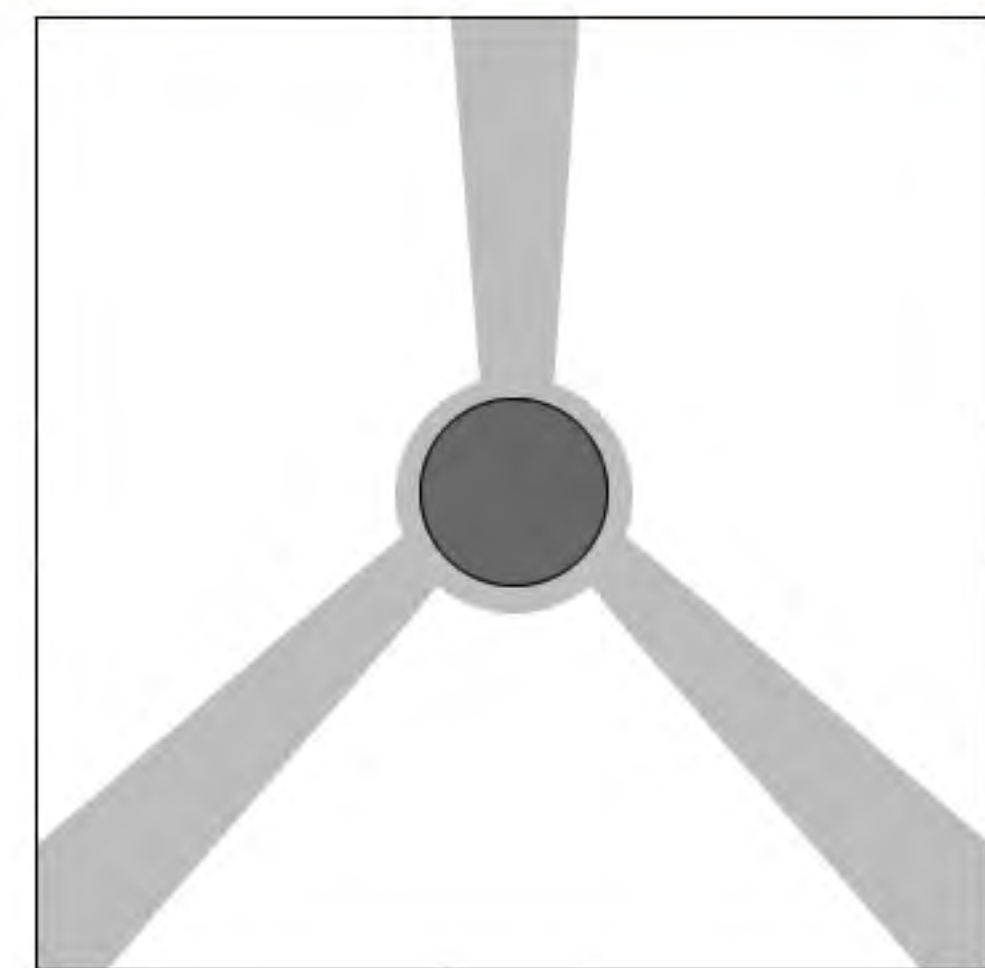

top view (俯视图)

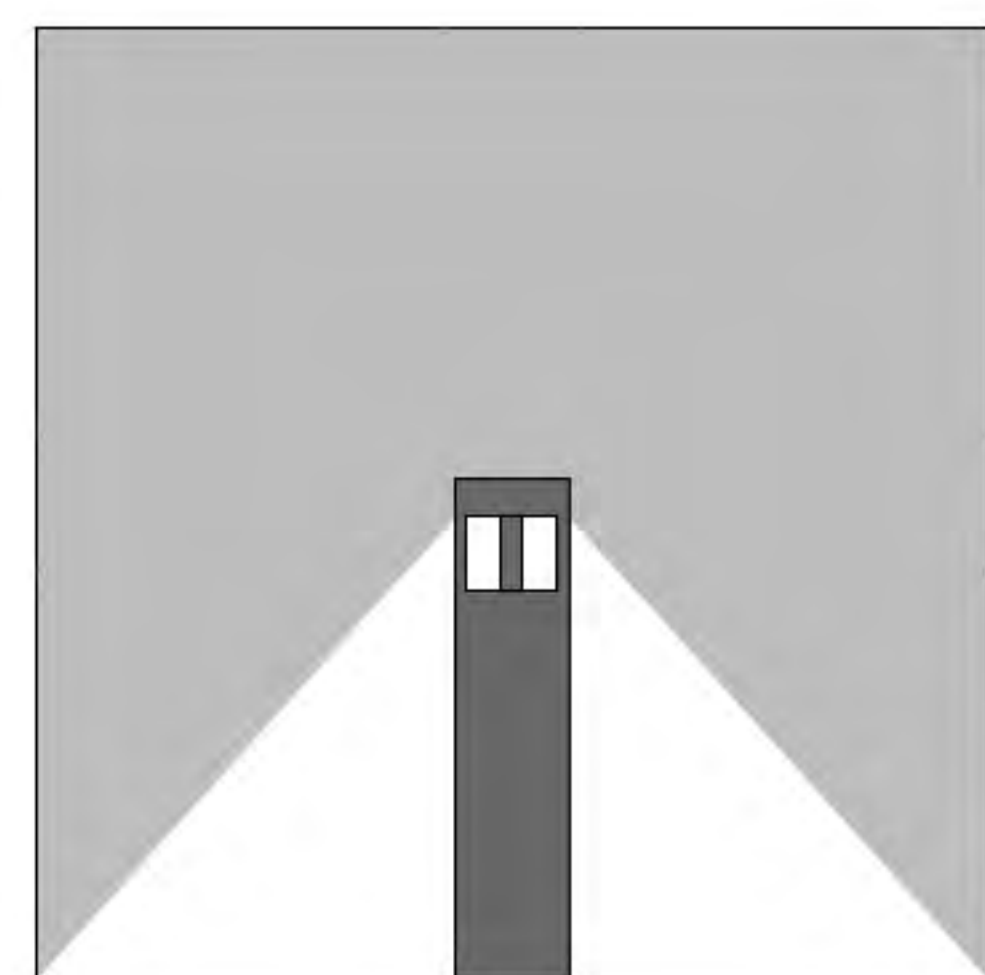

front view (正面图)

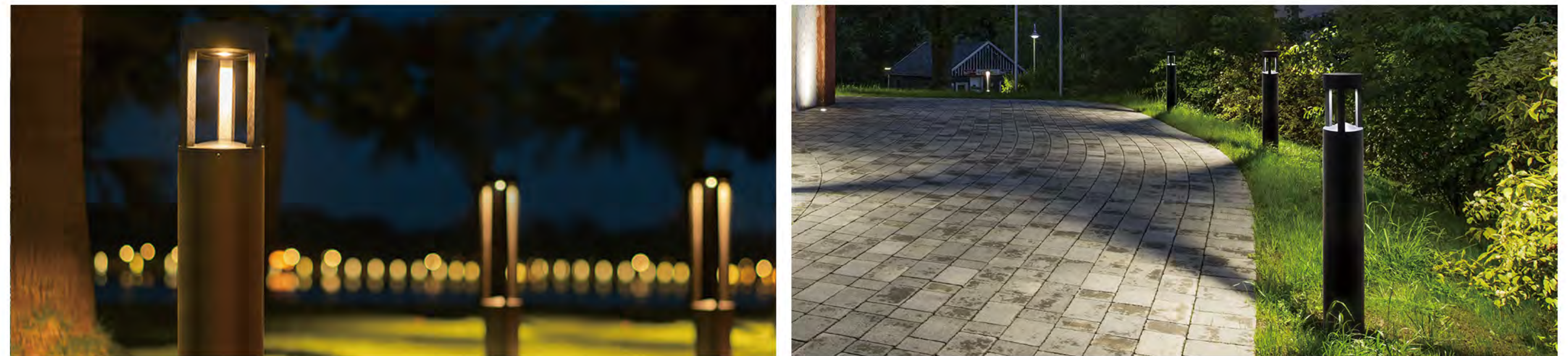

## Technical Date (技术参数)

Item No.	Lamp Type	Power	LM	CCT	PF	Voltage	CRI	A	B	C (mm)
MB21-BL01A	LED	10W	700	2700K-6000K	0.6	AC110-265V	80-90	Ø150	100	300
MB21-BL01B	LED	10W	700	2700K-6000K	0.6	AC110-265V	80-90	Ø150	400	600
MB21-BL01C	LED	10W	700	2700K-6000K	0.6	AC110-265V	80-90	Ø150	700	900



# MB21-BL02

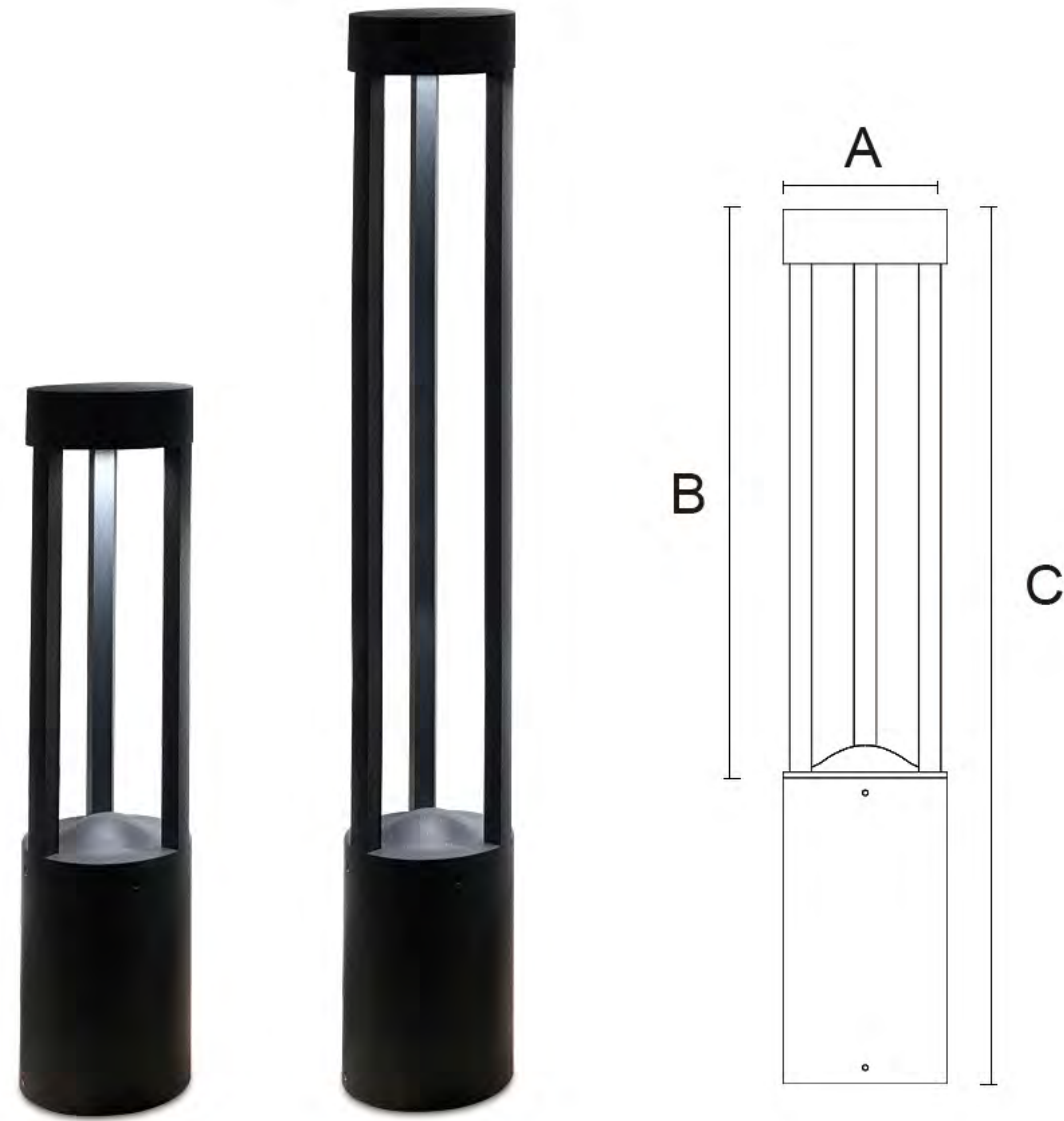

## Features&Benefit (功能和优点)

Category (品类)	Garden Light
Diffuser Material (扩散器材质)	Glass
Cover Material (面盖材质)	Aluminum
Operating mode (运行)	Built in
Steuerbar (开关)	On/Off
IP (防水等级)	54
Mounting type (安装类型)	Put
Mounting location (安装位置)	Overground
Application environment (应用环境)	Indoor/Outdoor
Body color (表面颜色)	Black/Dark Gray/Sliver Gray



## Product Description (产品描述)

Suitable for parks and gardens, neighborhoods, villas, city squares, pedestrian streets, scenic spots or resorts and other various scenes; lawn lamps can be a variety of heights at the same time the lighting effect will be different, more to provide a choice.

## Lightmap (光影图)

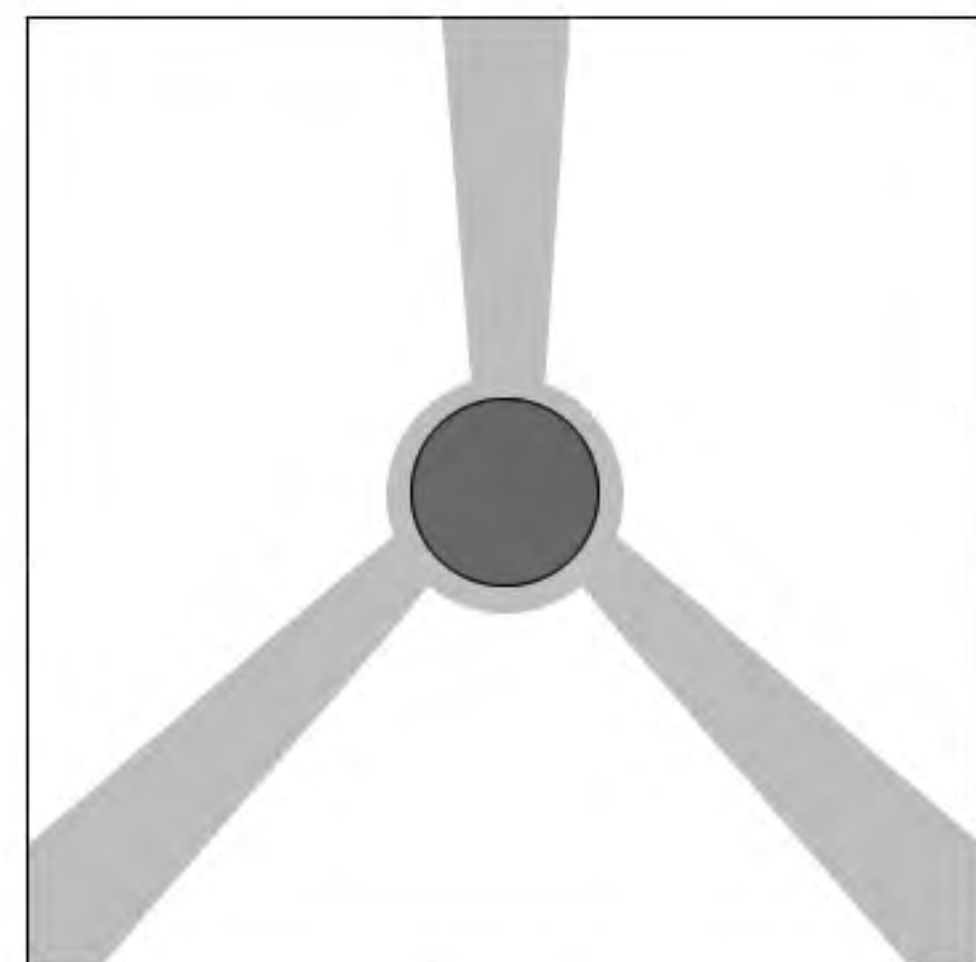

top view (俯视图)

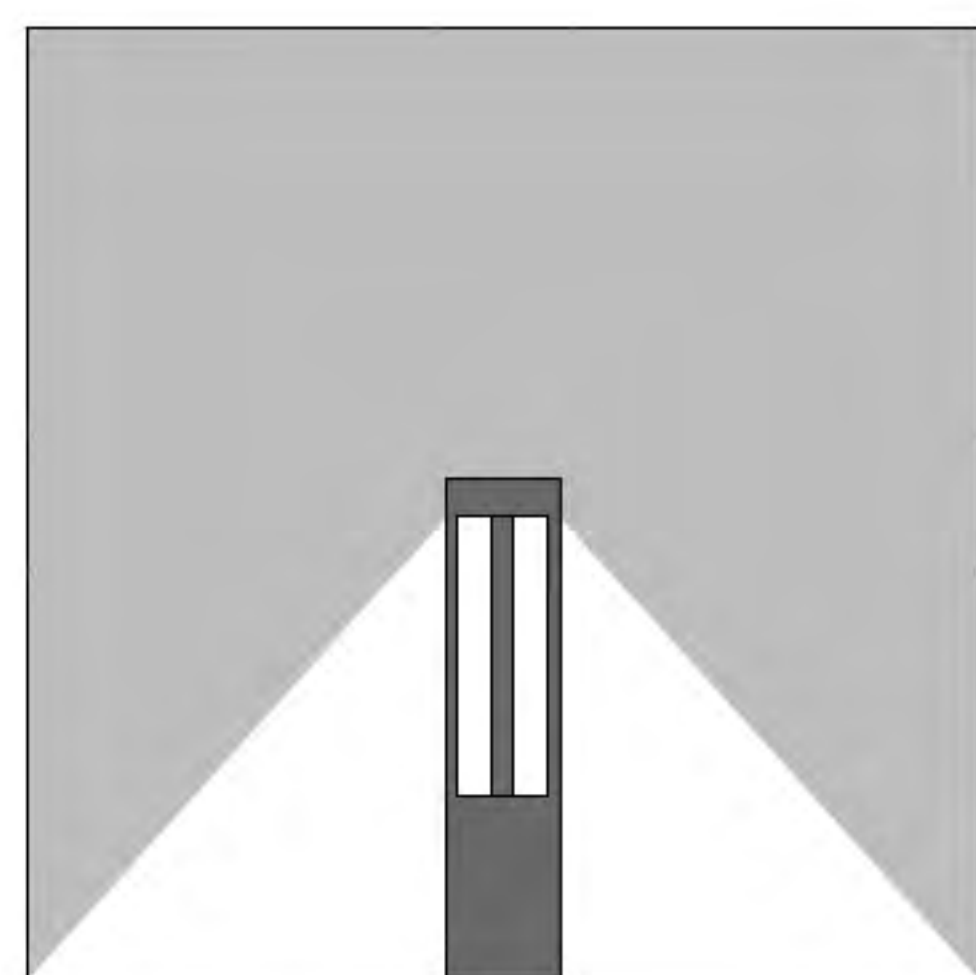

front view (正面图)



## Technical Date (技术参数)

Item No.	Lamp Type	Power	LM	CCT	PF	Voltage	CRI	A	B	C (mm)
MB21-BL02A	LED	10W	700	2700K-6000K	0.6	AC110-265V	80-90	Ø150	400	600
MB21-BL02B	LED	10W	700	2700K-6000K	0.6	AC110-265V	80-90	Ø150	700	900



# MB21-BL03

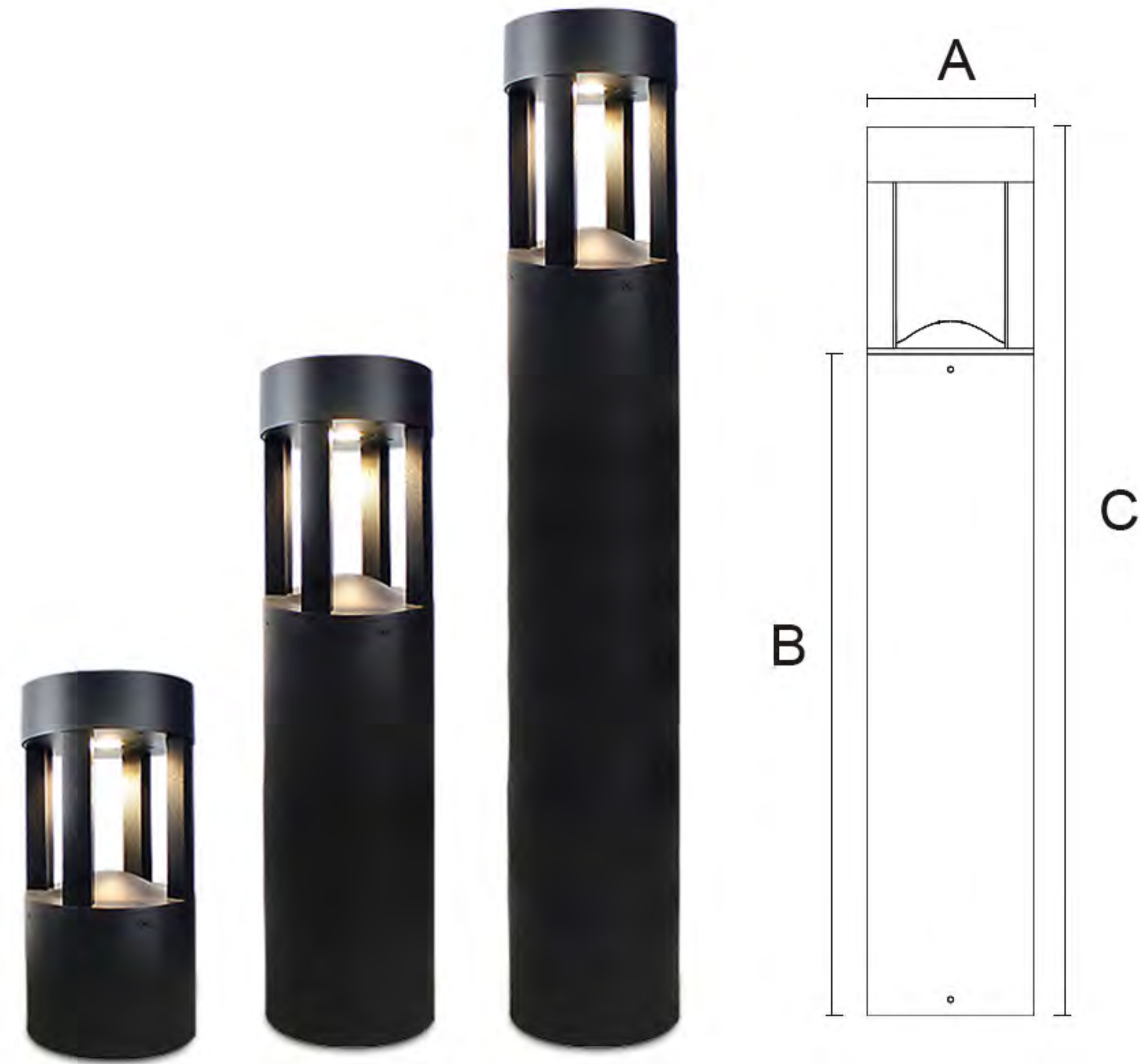

## Features&Benefit (功能和优点)

Category (品类)	Garden Light
Diffuser Material (扩散器材质)	Glass
Cover Material (面盖材质)	Aluminum
Operating mode (运行)	Built in
Steuerbar (开关)	On/Off
IP (防水等级)	54
Mounting type (安装类型)	Put
Mounting location (安装位置)	Overground
Application environment (应用环境)	Indoor/Outdoor
Body color (表面颜色)	Black/Dark Gray/Sliver Gray



## Product Description (产品描述)

Suitable for parks and gardens, neighborhoods, villas, city squares, pedestrian streets, scenic spots or resorts and other various scenes; lawn lamps can be a variety of heights at the same time the lighting effect will be different, more to provide a choice.

## Lightmap (光影图)

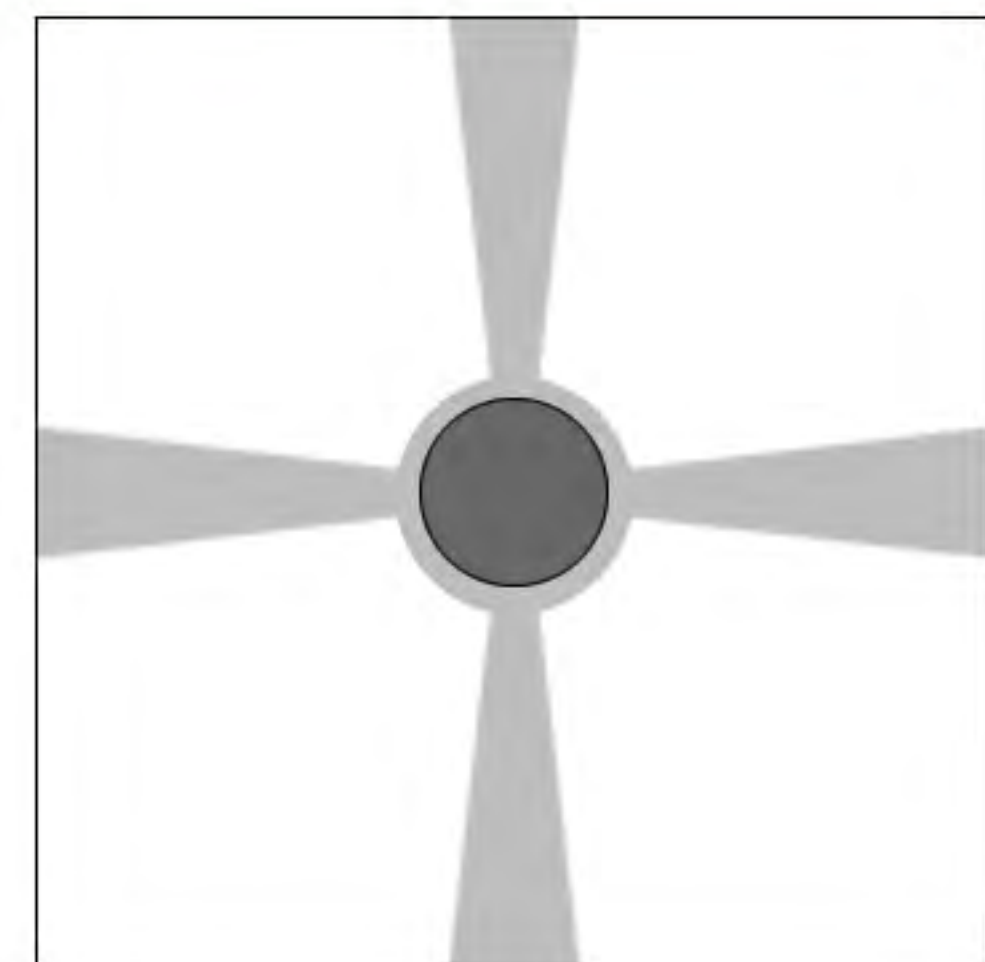

top view (俯视图)

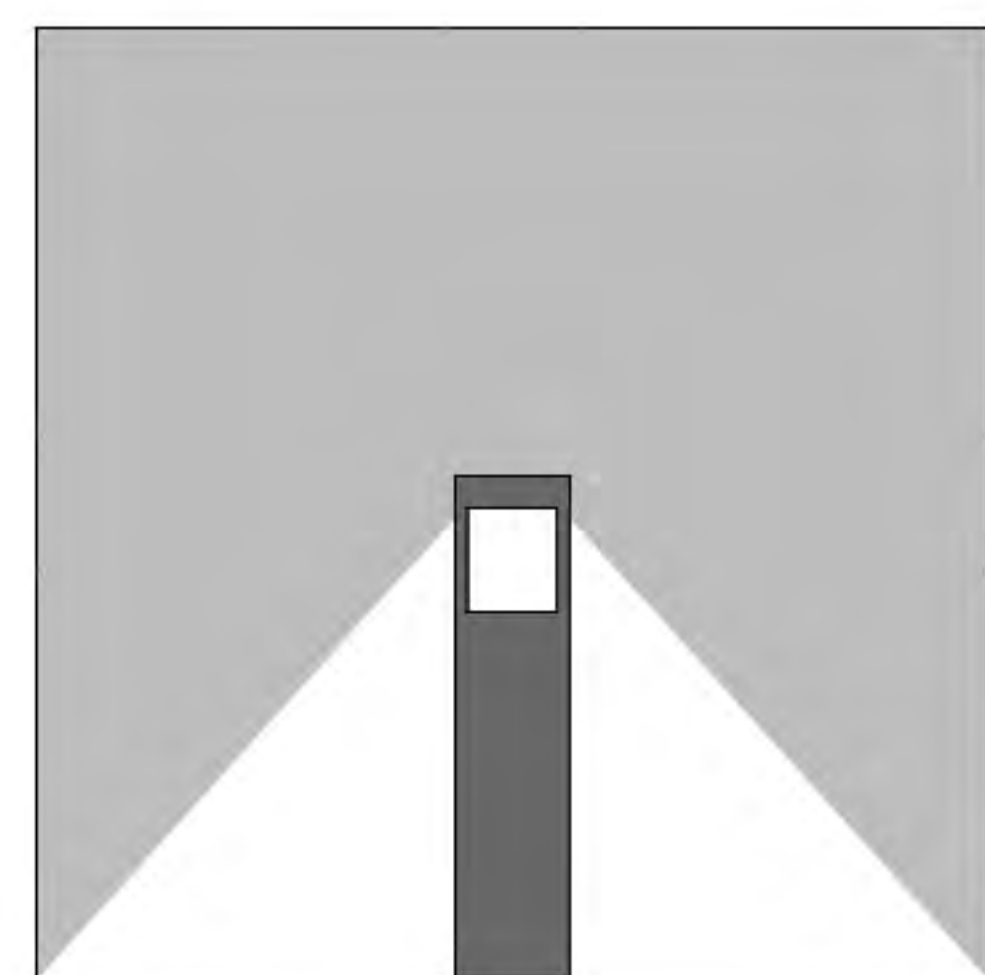

front view (正面图)



## Technical Date (技术参数)

Item No.	Lamp Type	Power	LM	CCT	PF	Voltage	CRI	A	B	C (mm)
MB21-BL03A	LED	10W	700	2700K-6000K	0.6	AC110-265V	80-90	Ø150	100	300
MB21-BL03B	LED	10W	700	2700K-6000K	0.6	AC110-265V	80-90	Ø150	400	600
MB21-BL03C	LED	10W	700	2700K-6000K	0.6	AC110-265V	80-90	Ø150	700	900



# MB21-BL04

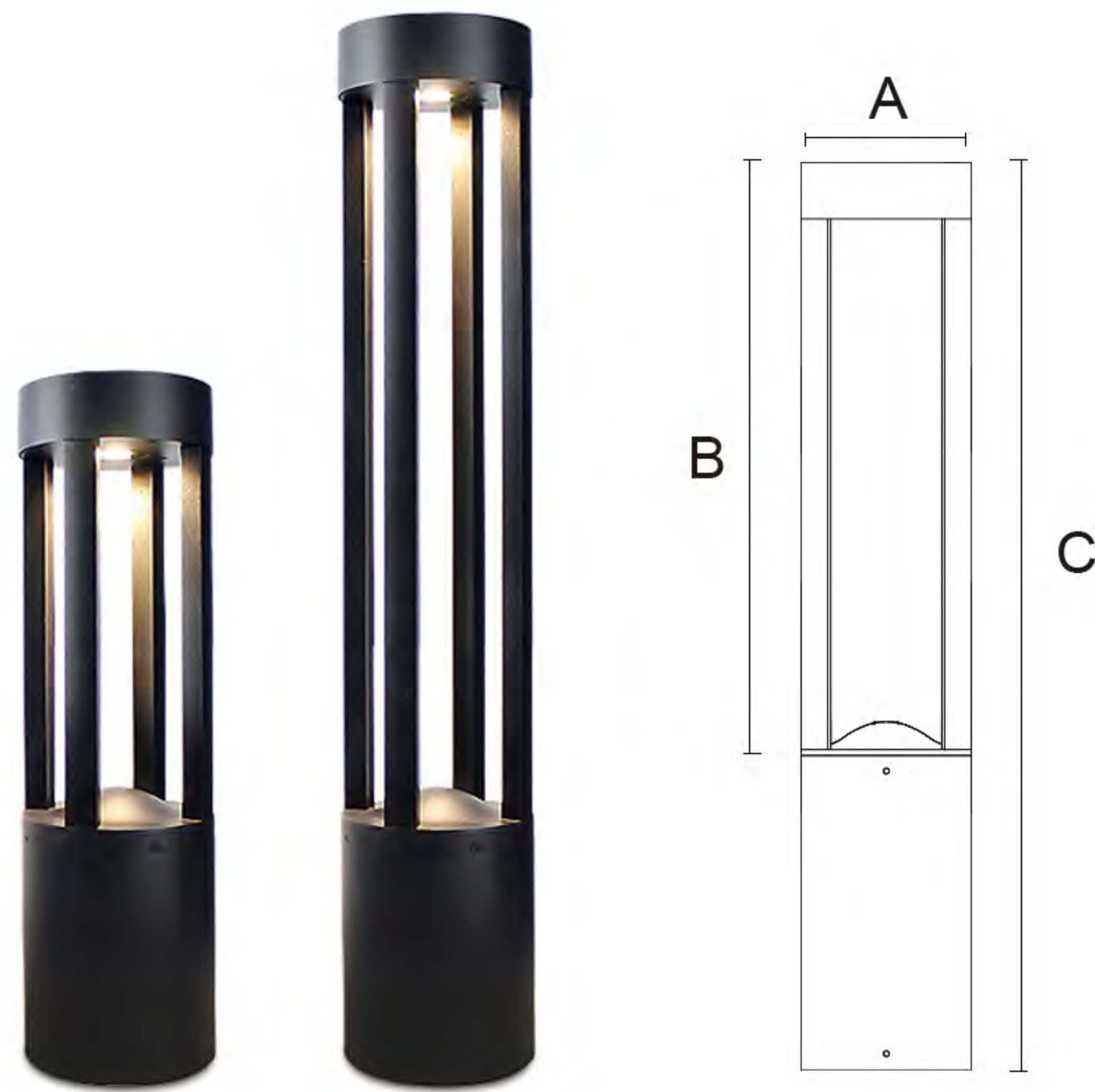

## Features&Benefit (功能和优点)

Category (品类)	Garden Light
Diffuser Material (扩散器材质)	Glass
Cover Material (面盖材质)	Aluminum
Operating mode (运行)	Built in
Steuerbar (开关)	On/Off
IP (防水等级)	54
Mounting type (安装类型)	Put
Mounting location (安装位置)	Overground
Application environment (应用环境)	Indoor/Outdoor
Body color (表面颜色)	Black/Dark Gray/Sliver Gray



## Product Description (产品描述)

Suitable for parks and gardens, neighborhoods, villas, city squares, pedestrian streets, scenic spots or resorts and other various scenes; lawn lamps can be a variety of heights at the same time the lighting effect will be different, more to provide a choice.

## Lightmap (光影图)

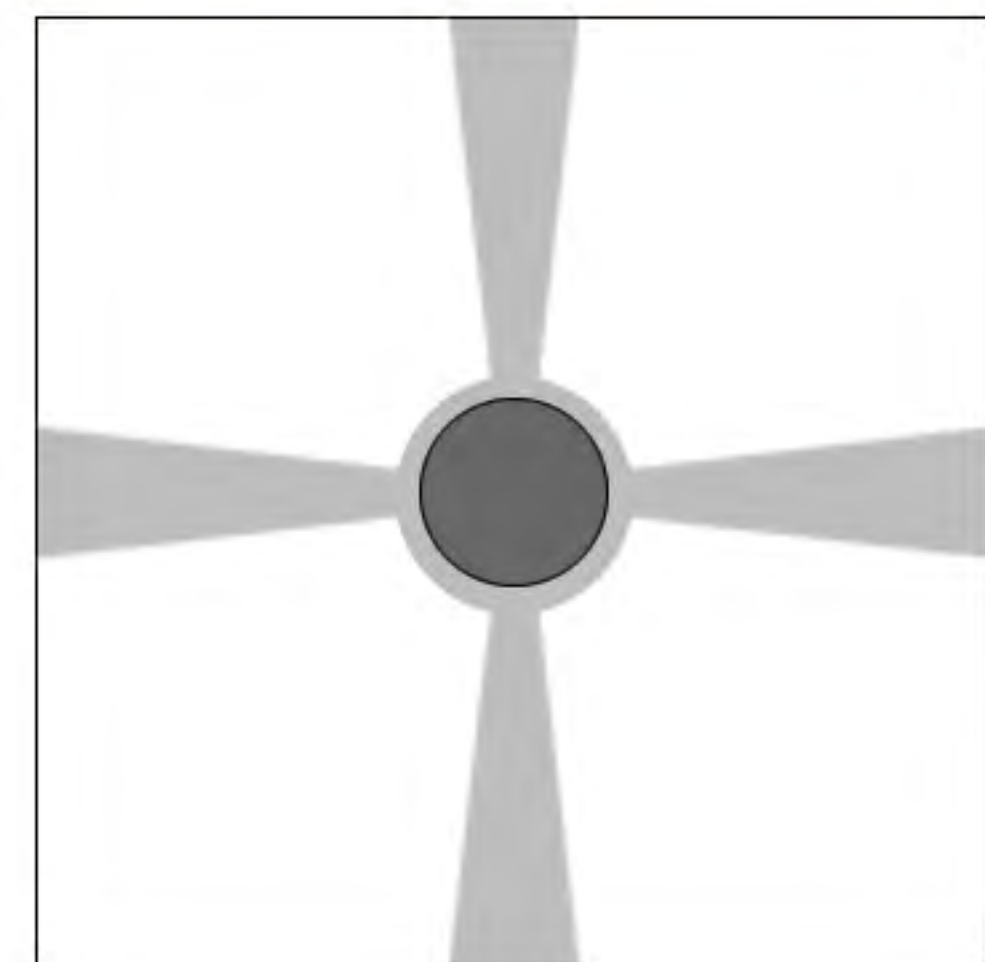

top view (俯视图)

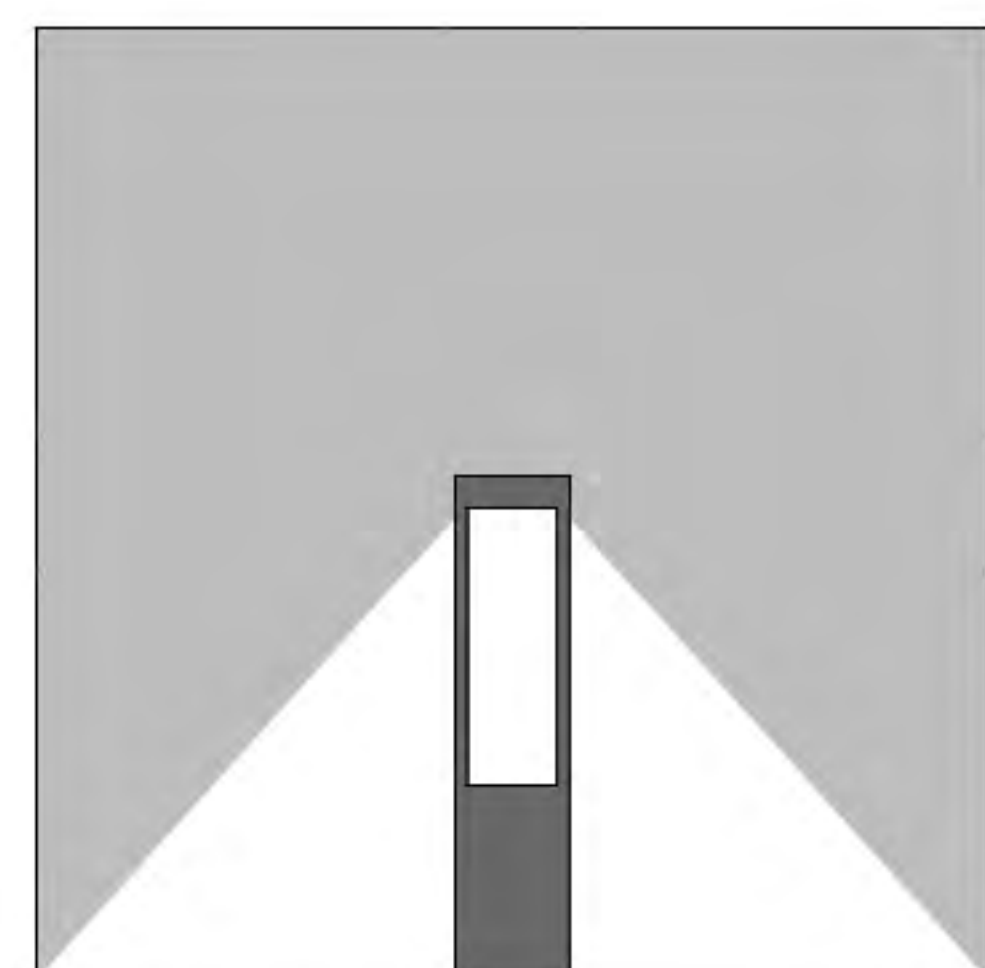

front view (正面图)



## Technical Date (技术参数)

Item No.	Lamp Type	Power	LM	CCT	PF	Voltage	CRI	A	B	C (mm)
MB21-BL04A	LED	10W	700	2700K-6000K	0.6	AC110-265V	80-90	Ø150	400	600
MB21-BL04B	LED	10W	700	2700K-6000K	0.6	AC110-265V	80-90	Ø150	700	900



# MB21-BL05

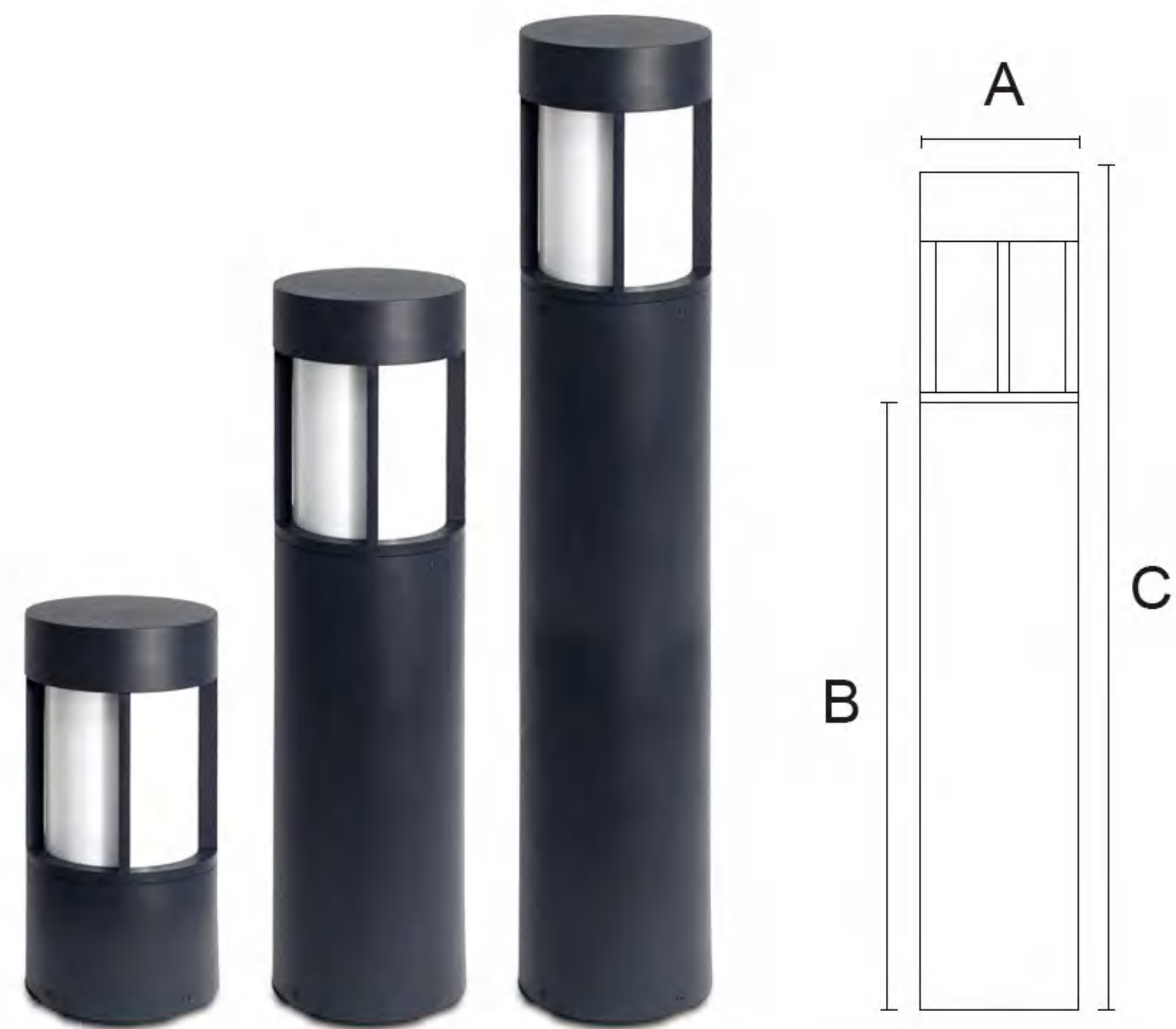

## Features&Benefit (功能和优点)

Category (品类)	Garden Light
Diffuser Material (扩散器材质)	Acrylic
Cover Material (面盖材质)	Aluminum
Operating mode (运行)	Built in
Steuerbar (开关)	On/Off
IP (防水等级)	54
Mounting type (安装类型)	Put
Mounting location (安装位置)	Overground
Application environment (应用环境)	Indoor/Outdoor
Body color (表面颜色)	Black/Dark Gray/Sliver Gray



## Product Description (产品描述)

Suitable for parks and gardens, neighborhoods, villas, city squares, pedestrian streets, scenic spots or resorts and other various scenes; lawn lamps can be a variety of heights at the same time the lighting effect will be different, more to provide a choice.

## Lightmap (光影图)



top view (俯视图)

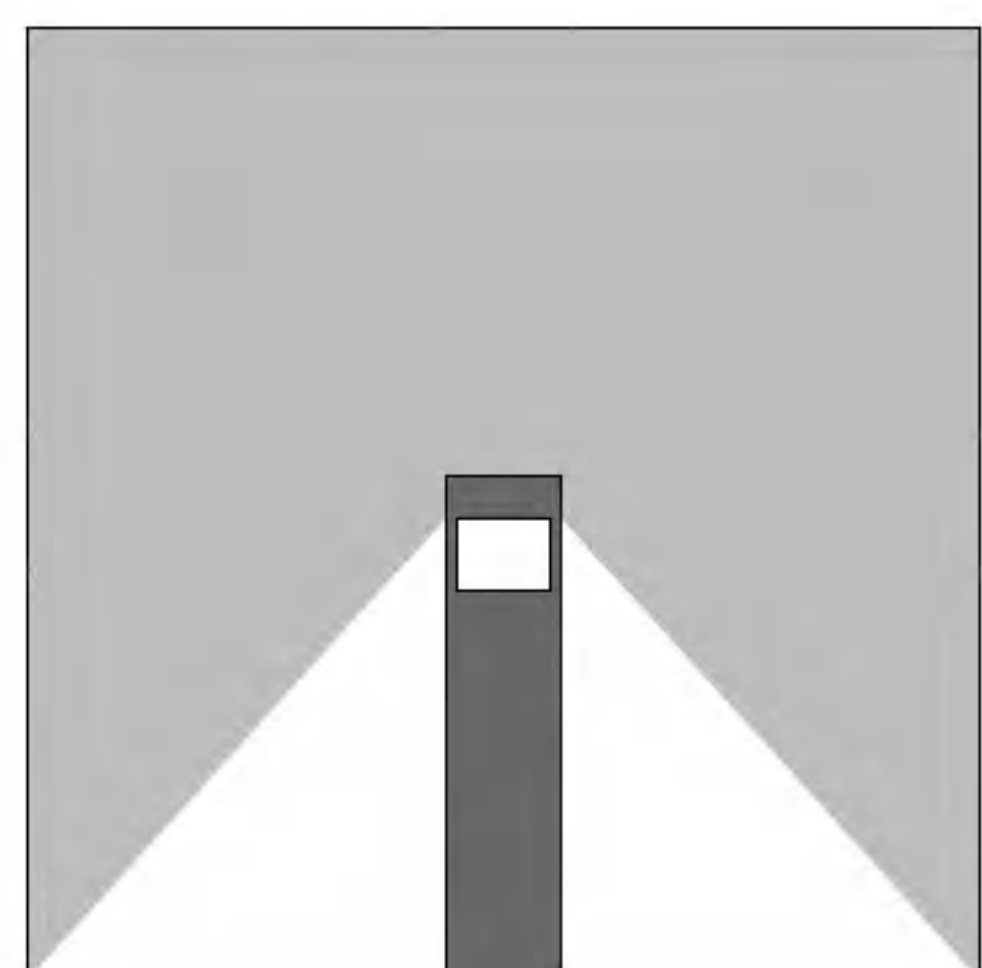

front view (正面图)



## Technical Date (技术参数)

Item No.	Lamp Type	Power	LM	CCT	PF	Voltage	CRI	A	B	C (mm)
MB21-BL05A/150	LED	15W	1050	2700K-6000K	0.6	AC110-265V	80-90	Ø150	100	300
MB21-BL05B/150	LED	15W	1050	2700K-6000K	0.6	AC110-265V	80-90	Ø150	400	600
MB21-BL05C/150	LED	15W	1050	2700K-6000K	0.6	AC110-265V	80-90	Ø150	700	900
MB21-BL05A/200	LED	15W	1050	2700K-6000K	0.6	AC110-265V	80-90	Ø200	100	300
MB21-BL05B/200	LED	15W	1050	2700K-6000K	0.6	AC110-265V	80-90	Ø200	400	600
MB21-BL05C/200	LED	15W	1050	2700K-6000K	0.6	AC110-265V	80-90	Ø200	700	900



# MB21-BL06

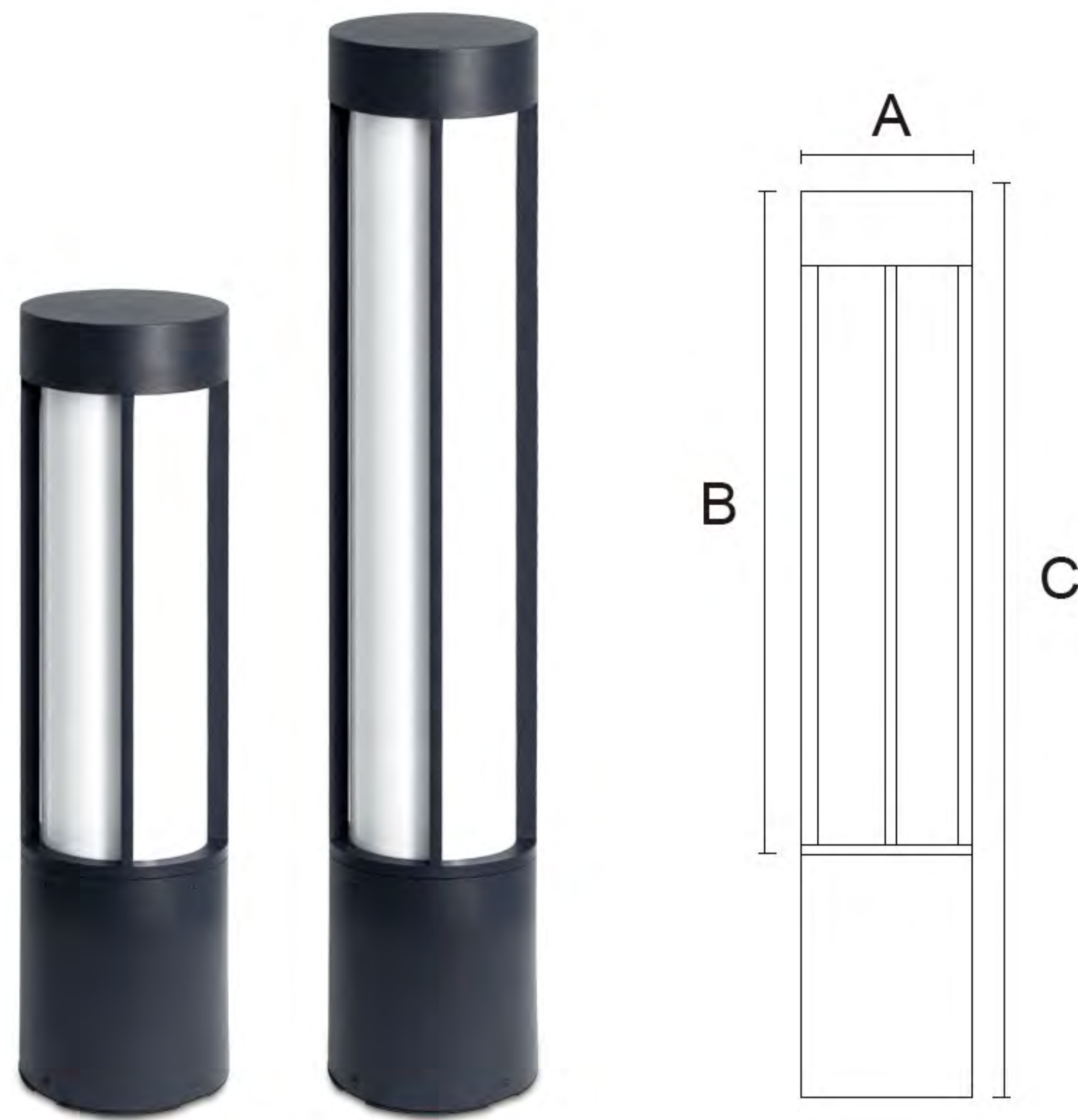

## Features&Benefit (功能和优点)

Category (品类)	Garden Light
Diffuser Material (扩散器材质)	Acrylic
Cover Material (面盖材质)	Aluminum
Operating mode (运行)	Built in
Steuerbar (开关)	On/Off
IP (防水等级)	54
Mounting type (安装类型)	Put
Mounting location (安装位置)	Overground
Application environment (应用环境)	Indoor/Outdoor
Body color (表面颜色)	Black/Dark Gray/Sliver Gray



## Product Description (产品描述)

Suitable for parks and gardens, neighborhoods, villas, city squares, pedestrian streets, scenic spots or resorts and other various scenes; lawn lamps can be a variety of heights at the same time the lighting effect will be different, more to provide a choice.

## Lightmap (光影图)



top view (俯视图)

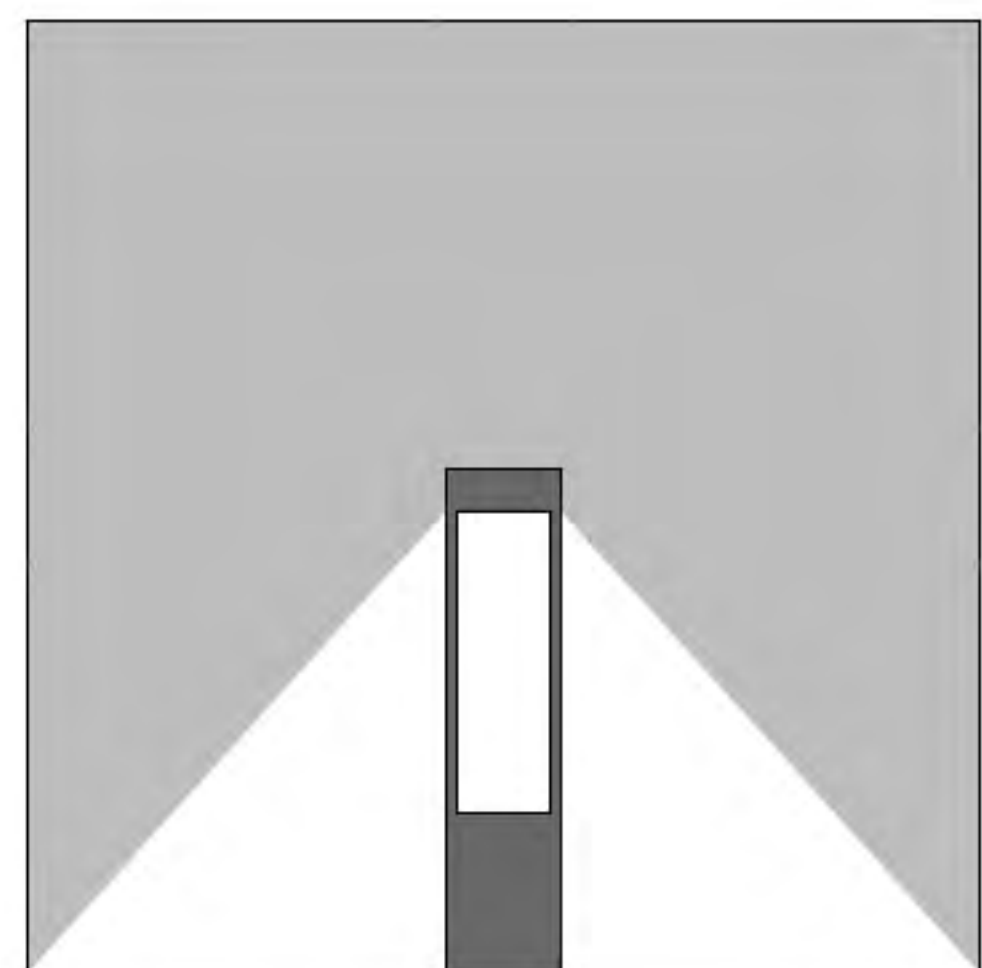

front view (正面图)

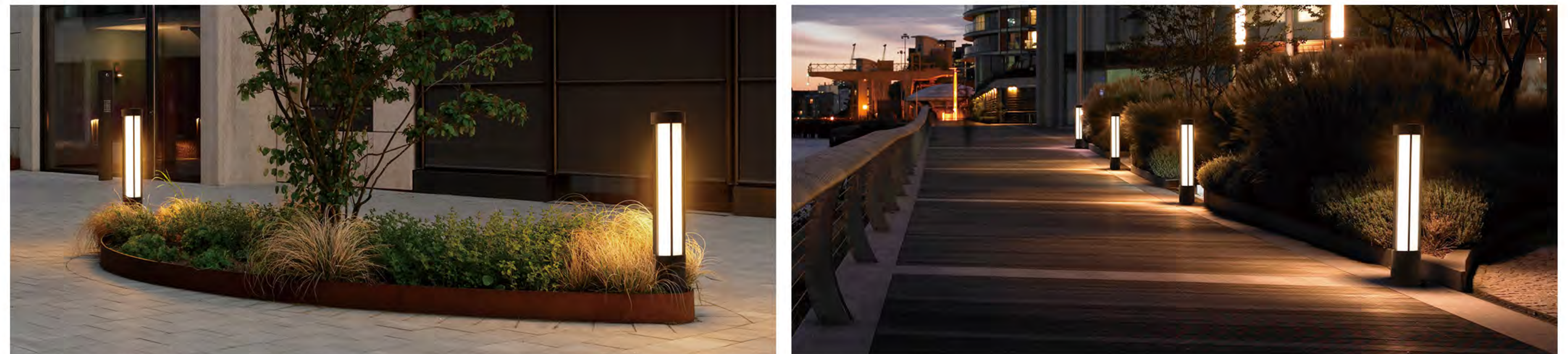

## Technical Date (技术参数)

Item No.	Lamp Type	Power	LM	CCT	PF	Voltage	CRI	A	B	C (mm)
MB21-BL06A/150	LED	20W	1400	2700K-6000K	0.6	AC110-265V	80-90	Ø150	400	600
MB21-BL06B/150	LED	20W	1400	2700K-6000K	0.6	AC110-265V	80-90	Ø150	700	900
MB21-BL06A/200	LED	20W	1400	2700K-6000K	0.6	AC110-265V	80-90	Ø200	400	600
MB21-BL06B/200	LED	20W	1400	2700K-6000K	0.6	AC110-265V	80-90	Ø200	700	900



# MB21-BL07

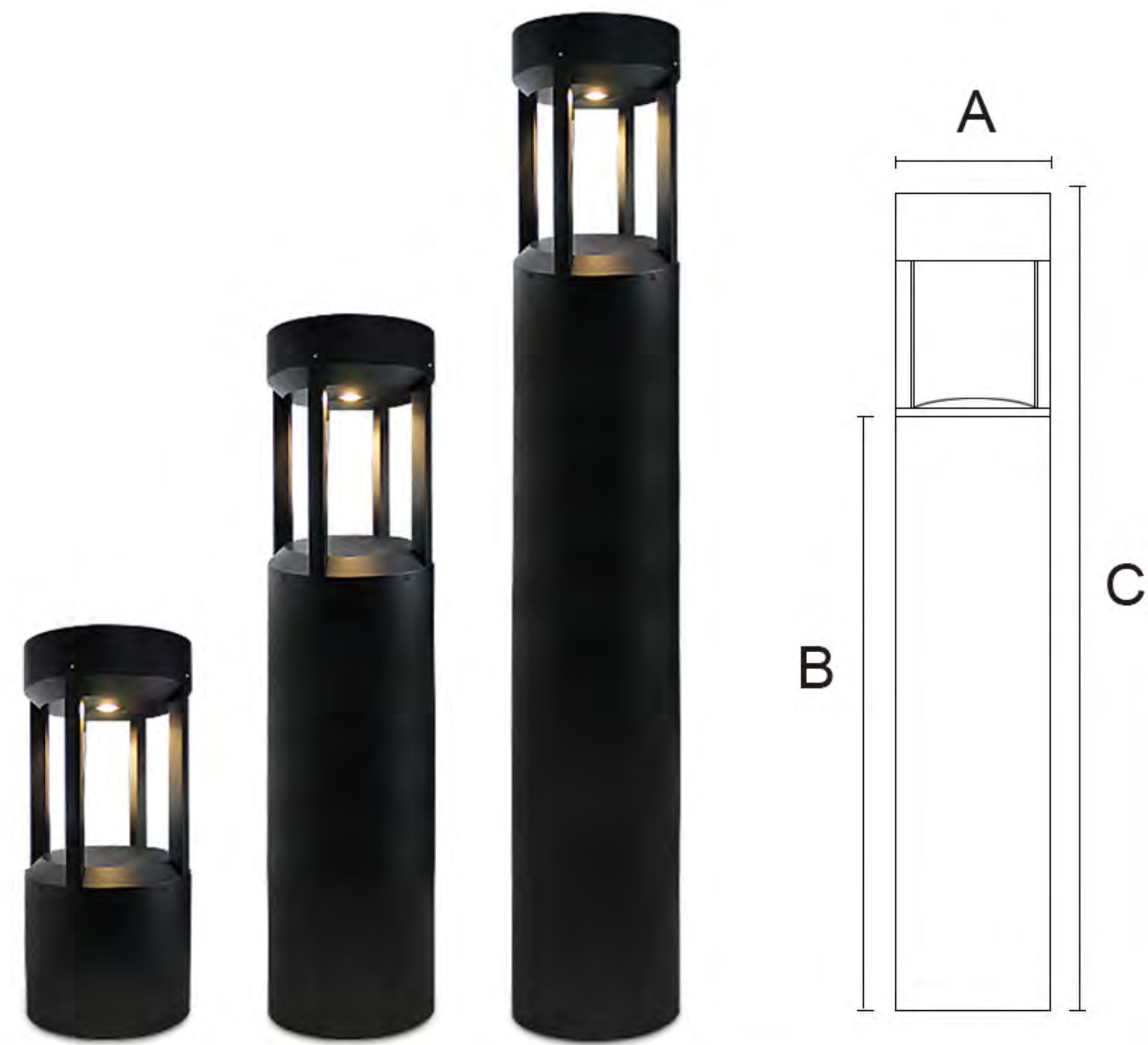

## Features&Benefit (功能和优点)

Category (品类)	Garden Light
Diffuser Material (扩散器材质)	Glass
Cover Material (面盖材质)	Aluminum
Operating mode (运行)	Built in
Steuerbar (开关)	On/Off
IP (防水等级)	54
Mounting type (安装类型)	Put
Mounting location (安装位置)	Overground
Application environment (应用环境)	Indoor/Outdoor
Body color (表面颜色)	Black/Dark Gray/Sliver Gray



## Product Description (产品描述)

Suitable for parks and gardens, neighborhoods, villas, city squares, pedestrian streets, scenic spots or resorts and other various scenes; lawn lamps can be a variety of heights at the same time the lighting effect will be different, more to provide a choice.

## Lightmap (光影图)

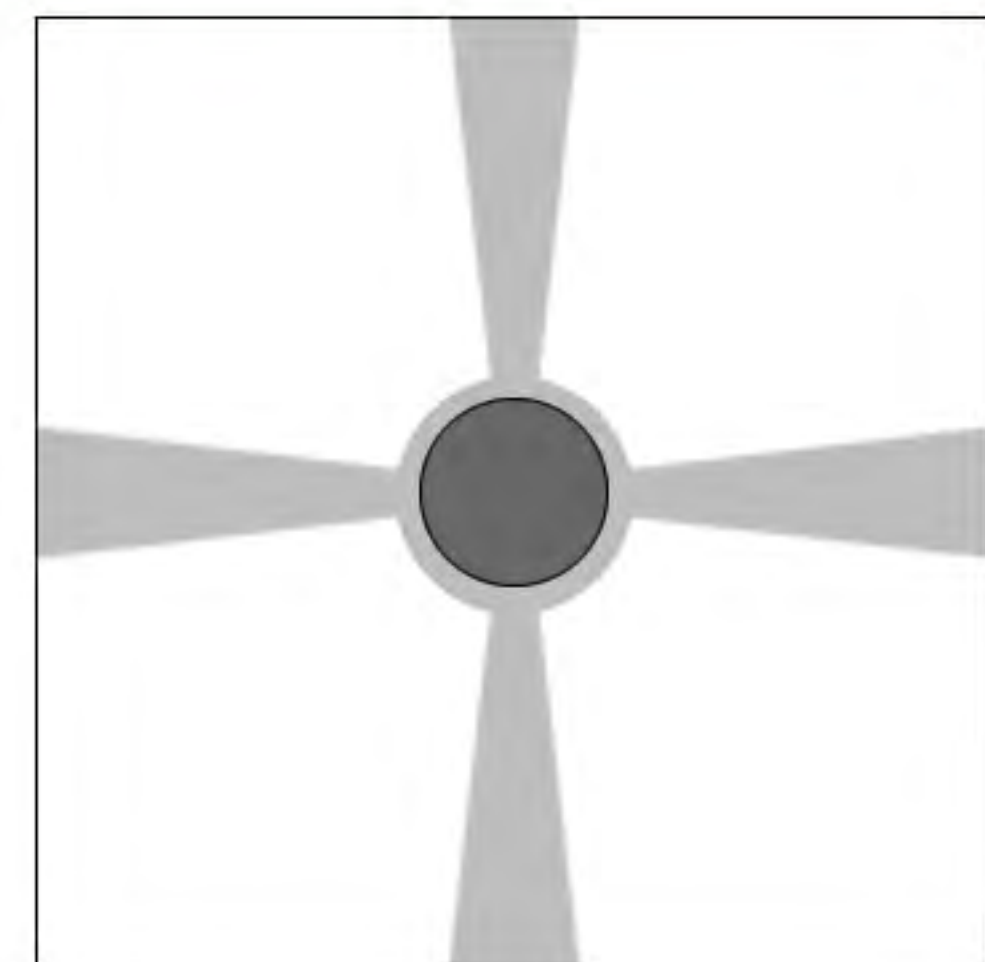

top view (俯视图)

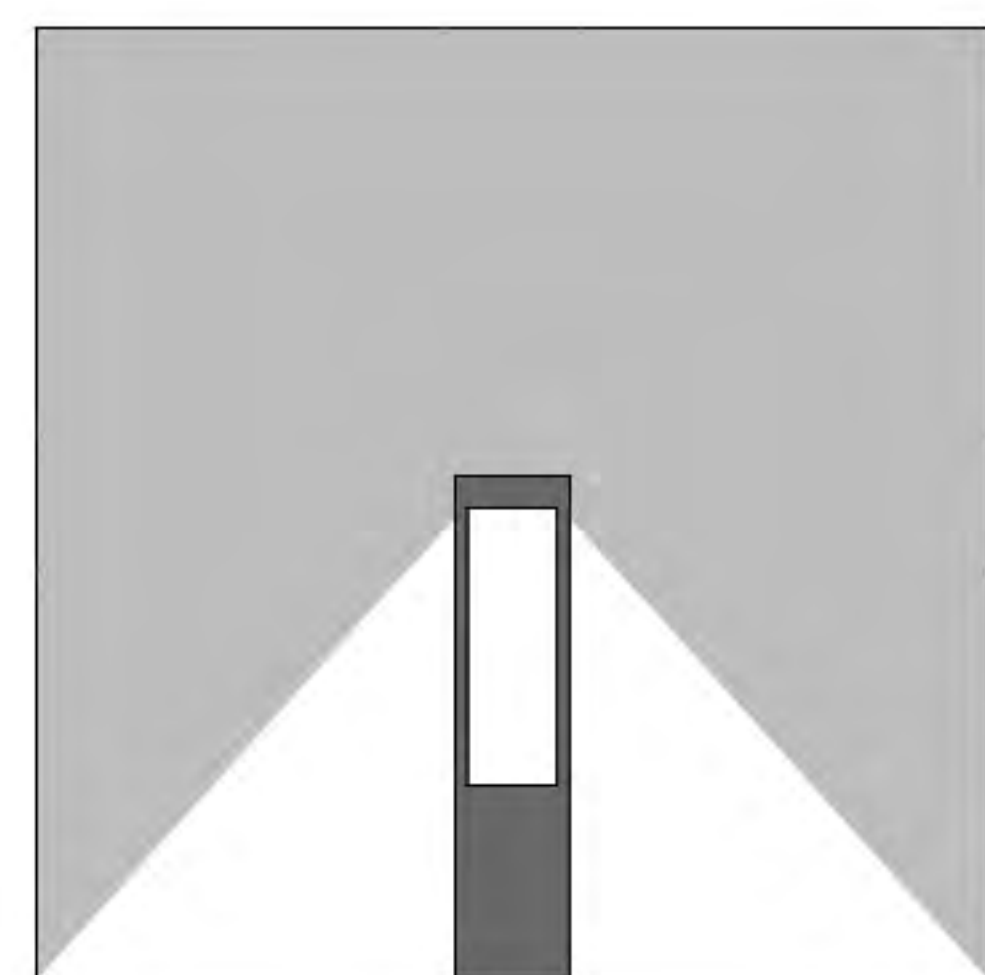

front view (正面图)

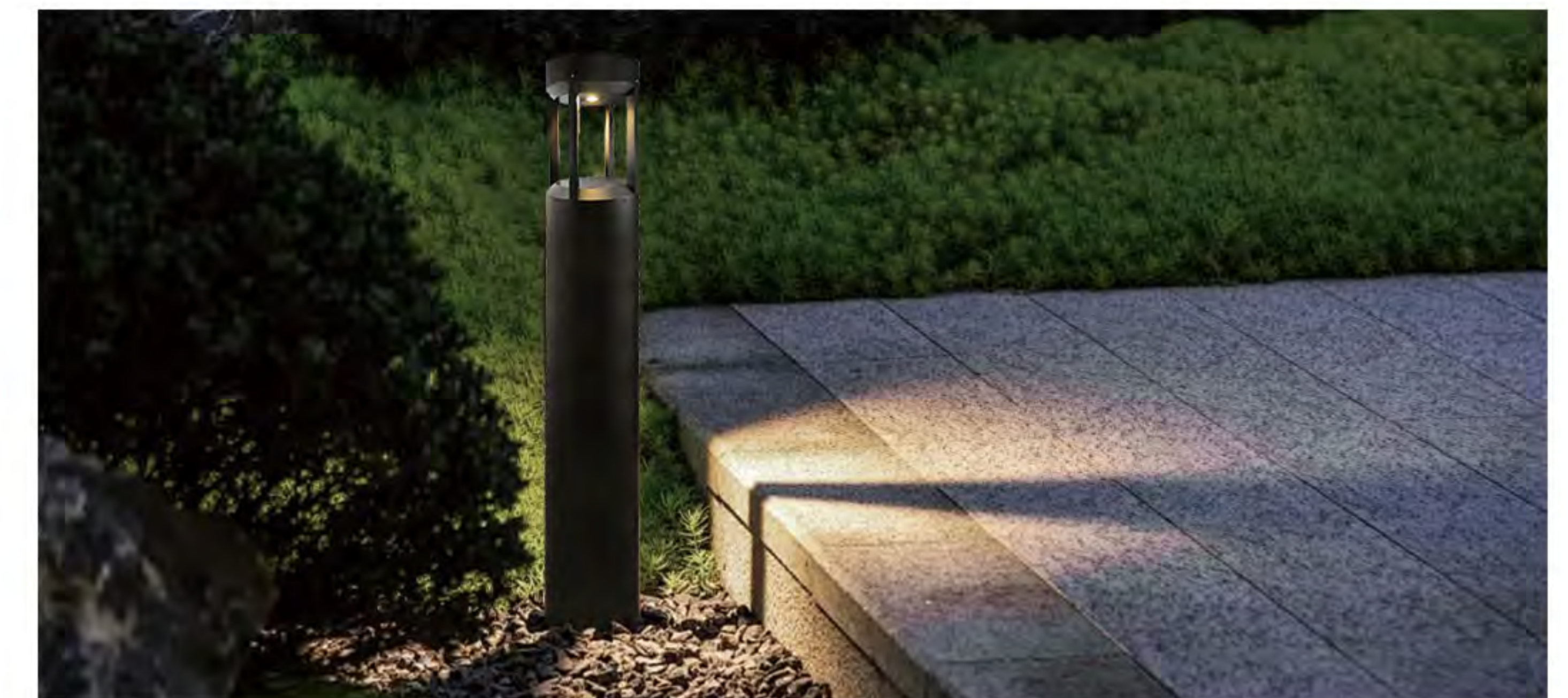

## Technical Date (技术参数)

Item No.	Lamp Type	Power	LM	CCT	PF	Voltage	CRI	A	B	C (mm)
MB21-BL07A	LED	15W	1050	2700K-6000K	0.6	AC110-265V	80-90	Ø200	100	300
MB21-BL07B	LED	15W	1050	2700K-6000K	0.6	AC110-265V	80-90	Ø200	400	600
MB21-BL07C	LED	15W	1050	2700K-6000K	0.6	AC110-265V	80-90	Ø200	700	900



# MB21-BL08

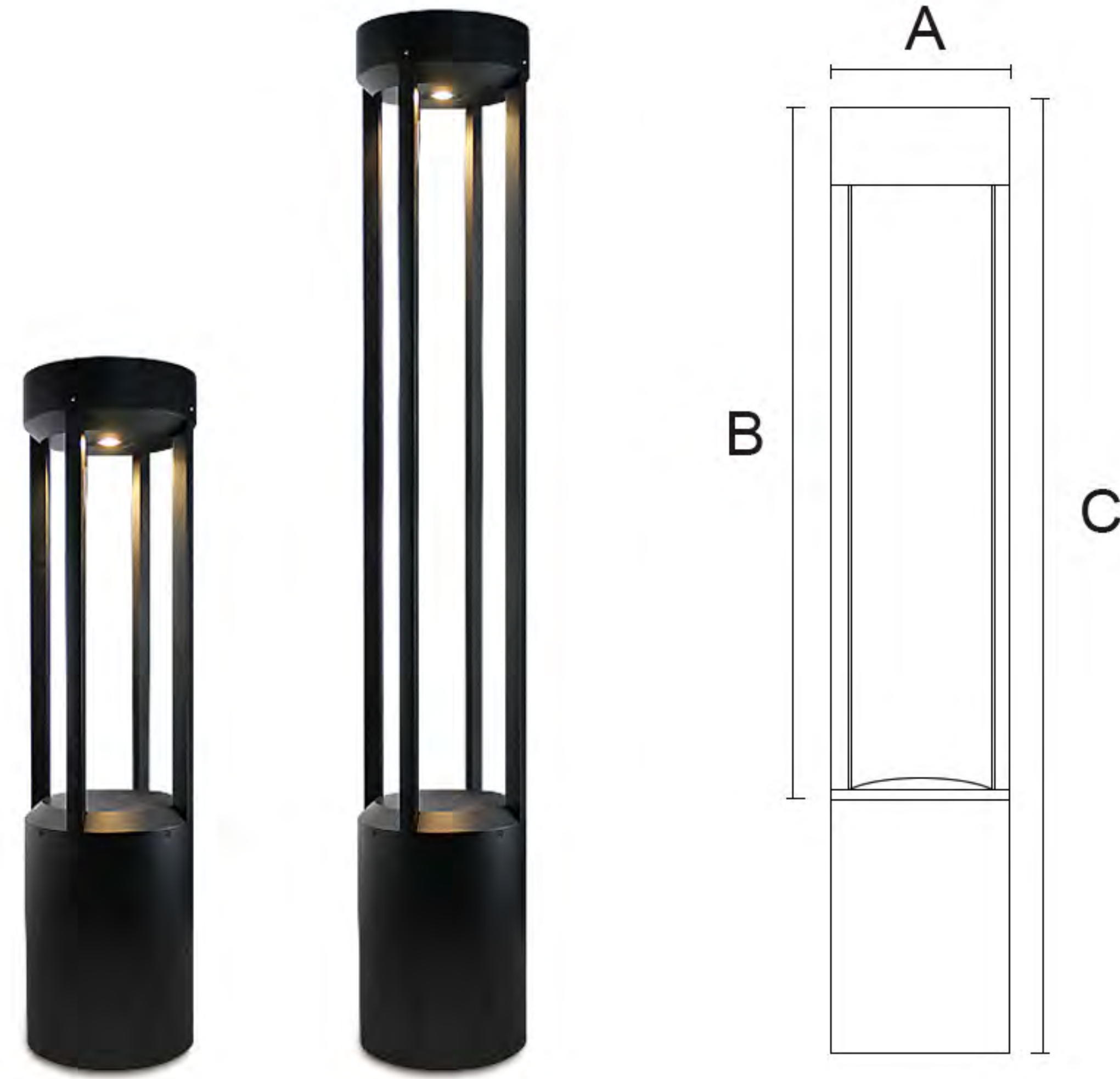

## Features&Benefit (功能和优点)

Category (品类)	Garden Light
Diffuser Material (扩散器材质)	Glass
Cover Material (面盖材质)	Aluminum
Operating mode (运行)	Built in
Steuerbar (开关)	On/Off
IP (防水等级)	54
Mounting type (安装类型)	Put
Mounting location (安装位置)	Overground
Application environment (应用环境)	Indoor/Outdoor
Body color (表面颜色)	Black/Dark Gray/Sliver Gray



## Product Description (产品描述)

Suitable for parks and gardens, neighborhoods, villas, city squares, pedestrian streets, scenic spots or resorts and other various scenes; lawn lamps can be a variety of heights at the same time the lighting effect will be different, more to provide a choice.

## Lightmap (光影图)

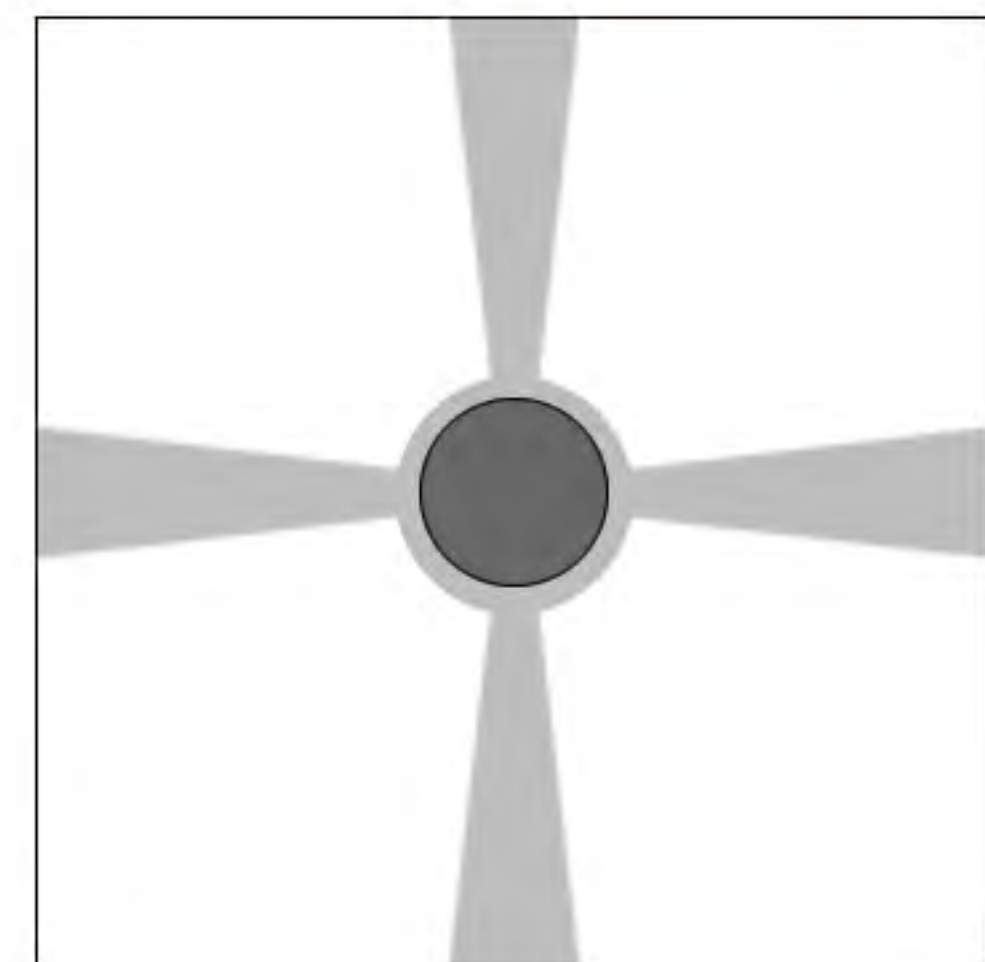

top view (俯视图)

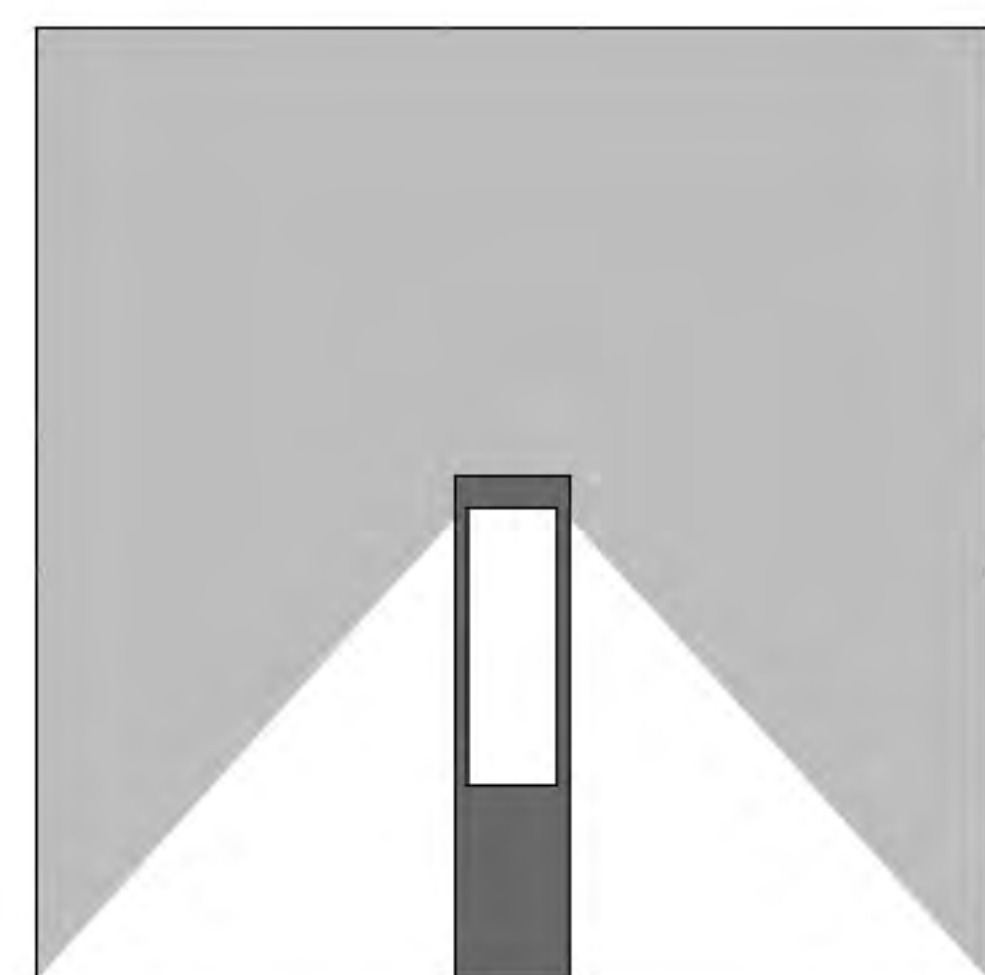

front view (正面图)



## Technical Date (技术参数)

Item No.	Lamp Type	Power	LM	CCT	PF	Voltage	CRI	A	B	C (mm)
MB21-BL08A	LED	15W	1050	2700K-6000K	0.6	AC110-265V	80-90	Ø200	400	600
MB21-BL08B	LED	15W	1050	2700K-6000K	0.6	AC110-265V	80-90	Ø200	700	900



# MB21-BL09

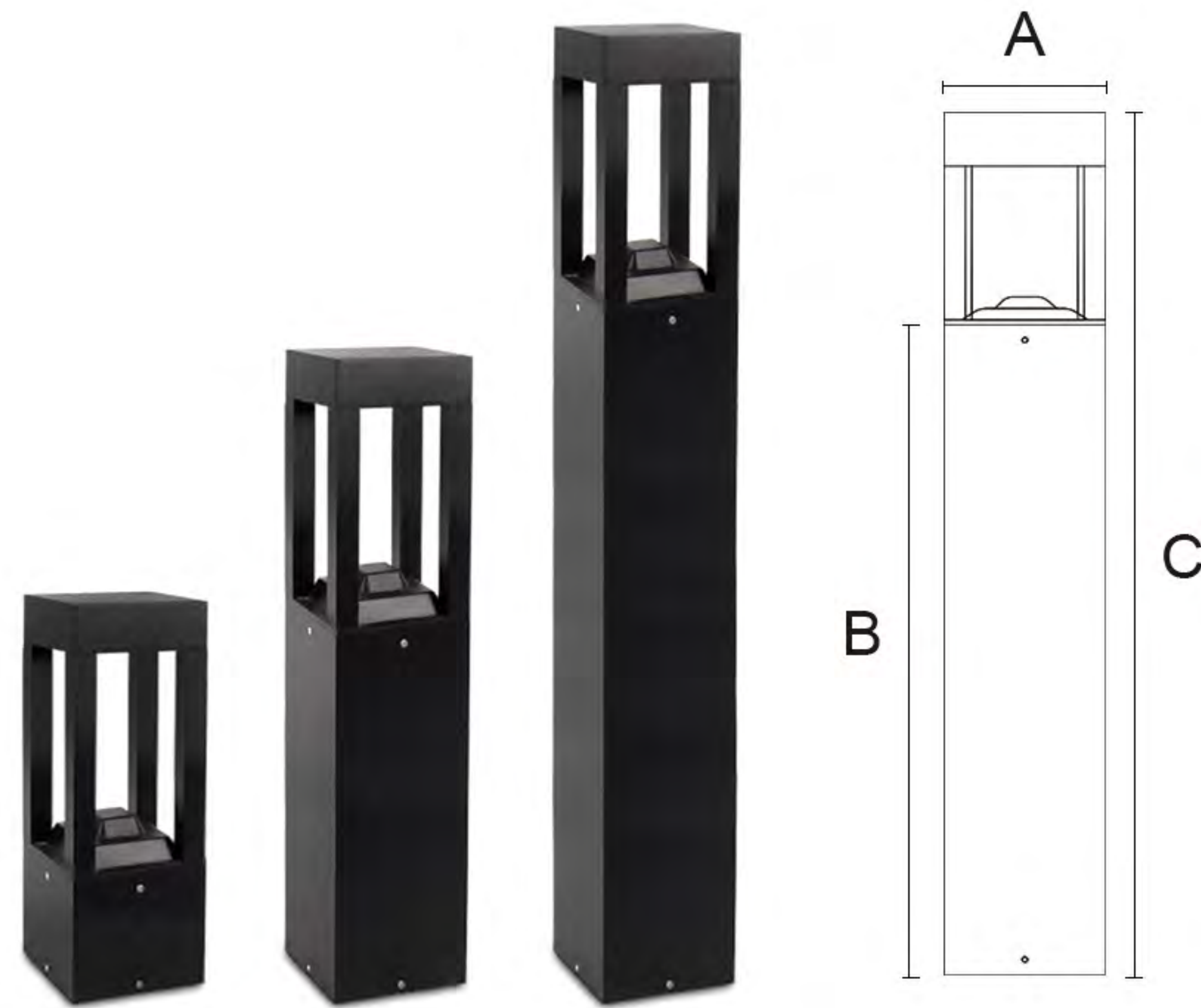

## Features&Benefit (功能和优点)

Category (品类)	Garden Light
Diffuser Material (扩散器材质)	Glass
Cover Material (面盖材质)	Aluminum
Operating mode (运行)	Built in
Steuerbar (开关)	On/Off
IP (防水等级)	54
Mounting type (安装类型)	Put
Mounting location (安装位置)	Overground
Application environment (应用环境)	Indoor/Outdoor
Body color (表面颜色)	Black/Dark Gray/Sliver Gray



## Product Description (产品描述)

Suitable for parks and gardens, neighborhoods, villas, city squares, pedestrian streets, scenic spots or resorts and other various scenes; lawn lamps can be a variety of heights at the same time the lighting effect will be different, more to provide a choice.

## Lightmap (光影图)

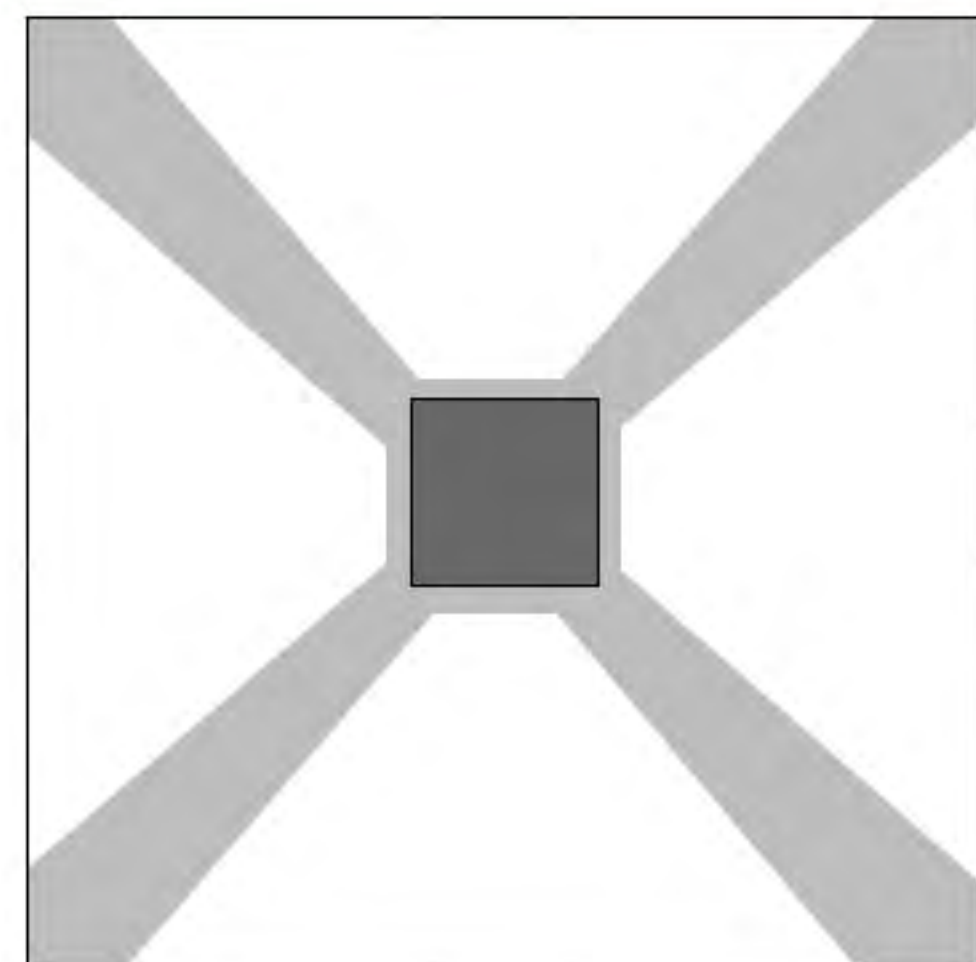

top view (俯视图)

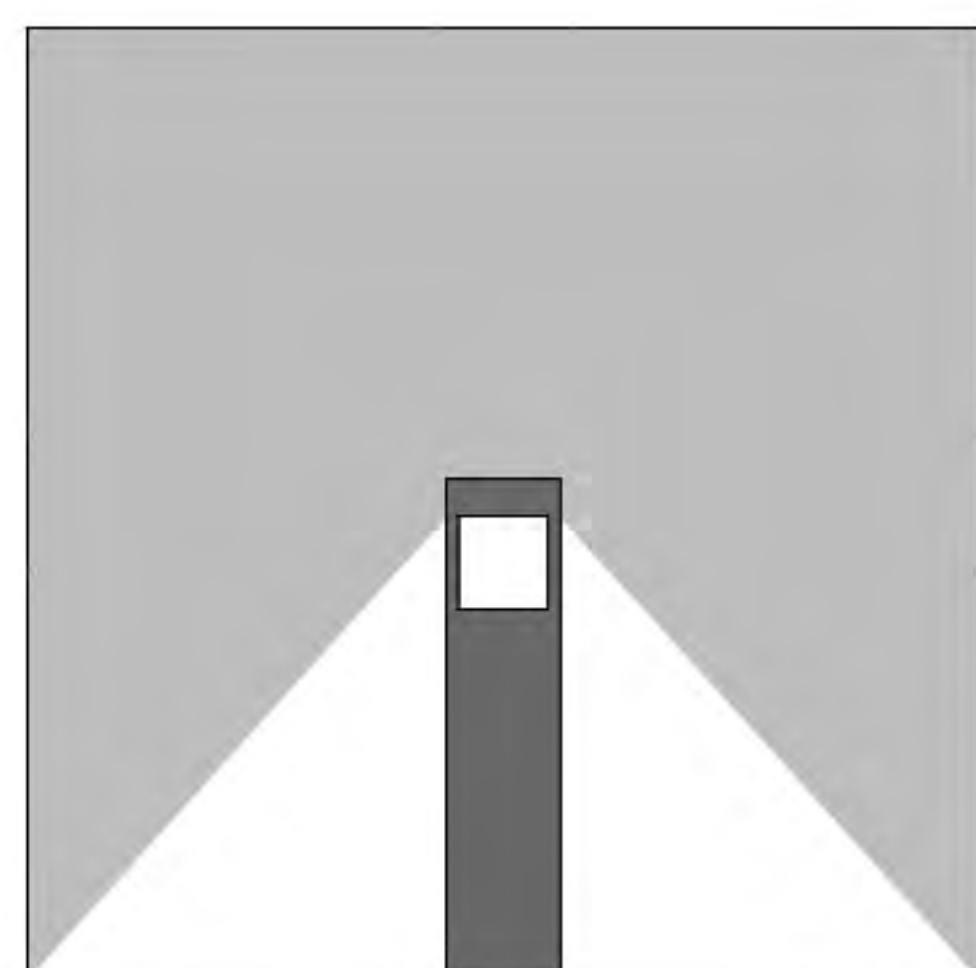

front view (正面图)



## Technical Date (技术参数)

Item No.	Lamp Type	Power	LM	CCT	PF	Voltage	CRI	A	B	C (mm)
MB21-BL09A	LED	10W	700	2700K-6000K	0.6	AC110-265V	80-90	150	100	300
MB21-BL09B	LED	10W	700	2700K-6000K	0.6	AC110-265V	80-90	150	400	600
MB21-BL09C	LED	10W	700	2700K-6000K	0.6	AC110-265V	80-90	150	700	900



# MB21-BL10

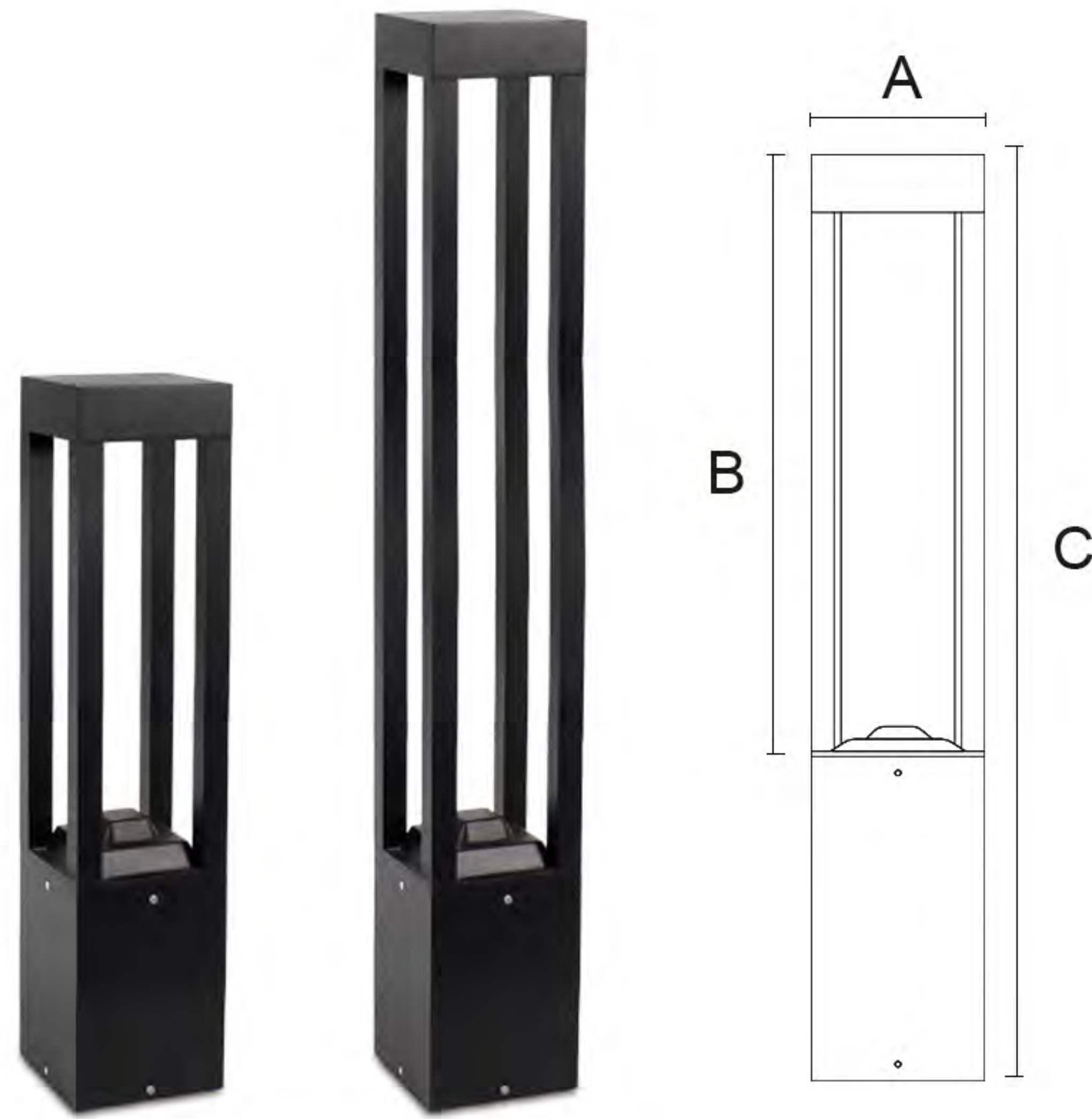

## Features&Benefit (功能和优点)

Category (品类)	Garden Light
Diffuser Material (扩散器材质)	Glass
Cover Material (面盖材质)	Aluminum
Operating mode (运行)	Built in
Steuerbar (开关)	On/Off
IP (防水等级)	54
Mounting type (安装类型)	Put
Mounting location (安装位置)	Overground
Application environment (应用环境)	Indoor/Outdoor
Body color (表面颜色)	Black/Dark Gray/Sliver Gray



## Product Description (产品描述)

Suitable for parks and gardens, neighborhoods, villas, city squares, pedestrian streets, scenic spots or resorts and other various scenes; lawn lamps can be a variety of heights at the same time the lighting effect will be different, more to provide a choice.

## Lightmap (光影图)

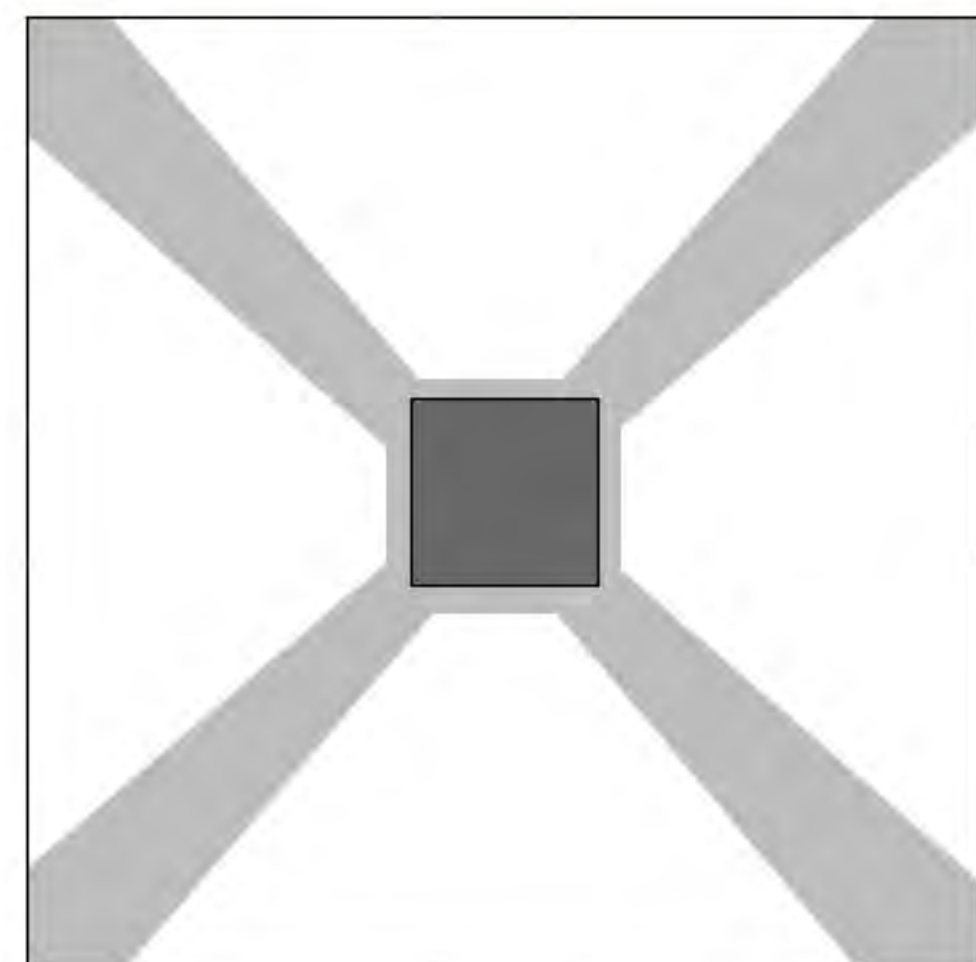

top view (俯视图)

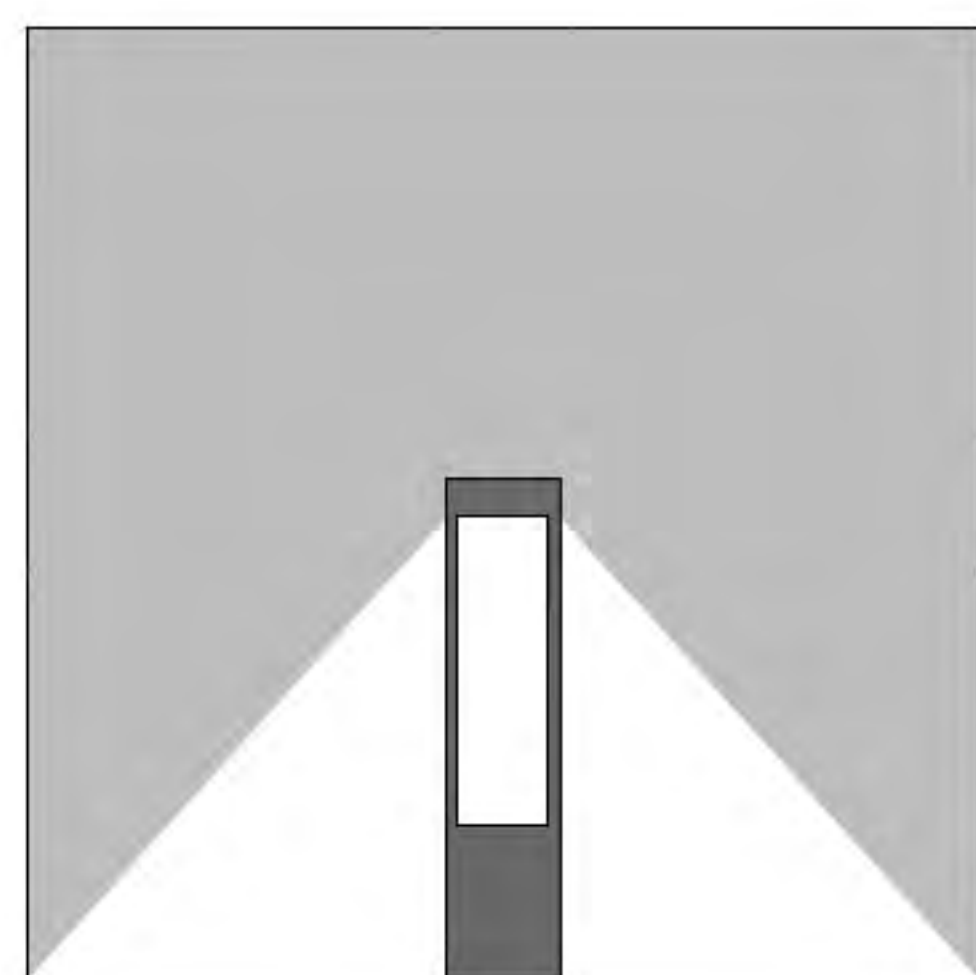

front view (正面图)



## Technical Date (技术参数)

Item No.	Lamp Type	Power	LM	CCT	PF	Voltage	CRI	A	B	C (mm)
MB21-BL10A	LED	10W	700	2700K-6000K	0.6	AC110-265V	80-90	150	400	600
MB21-BL10B	LED	10W	700	2700K-6000K	0.6	AC110-265V	80-90	150	700	900



# MB21-BL11

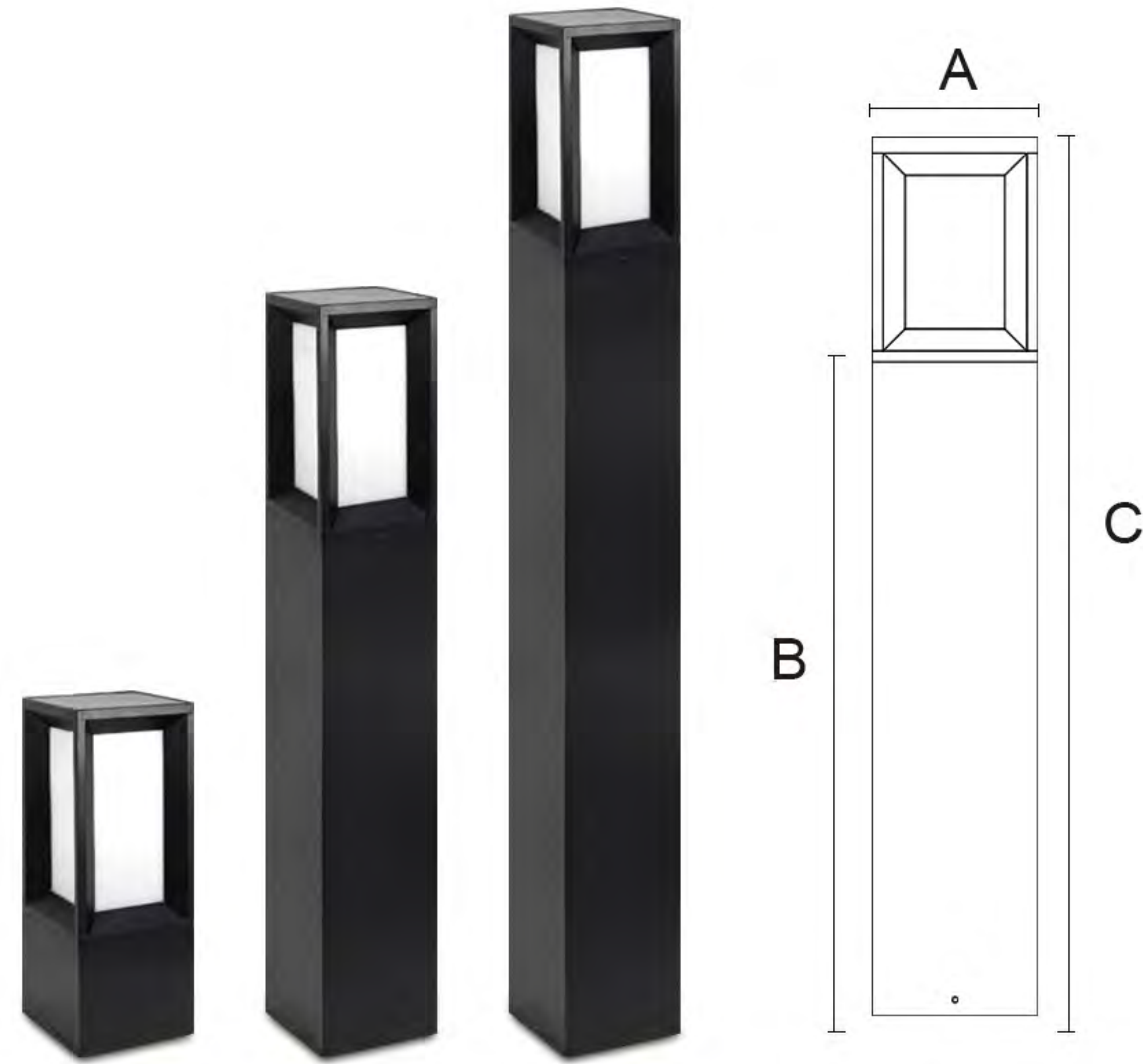

## Features&Benefit (功能和优点)

Category (品类)	Garden Light
Diffuser Material (扩散器材质)	Acrylic
Cover Material (面盖材质)	Aluminum
Operating mode (运行)	Built in
Steuerbar (开关)	On/Off
IP (防水等级)	54
Mounting type (安装类型)	Put
Mounting location (安装位置)	Overground
Application environment (应用环境)	Indoor/Outdoor
Body color (表面颜色)	Black/Dark Gray/Sliver Gray



## Product Description (产品描述)

Suitable for parks and gardens, neighborhoods, villas, city squares, pedestrian streets, scenic spots or resorts and other various scenes; lawn lamps can be a variety of heights at the same time the lighting effect will be different, more to provide a choice.

## Lightmap (光影图)

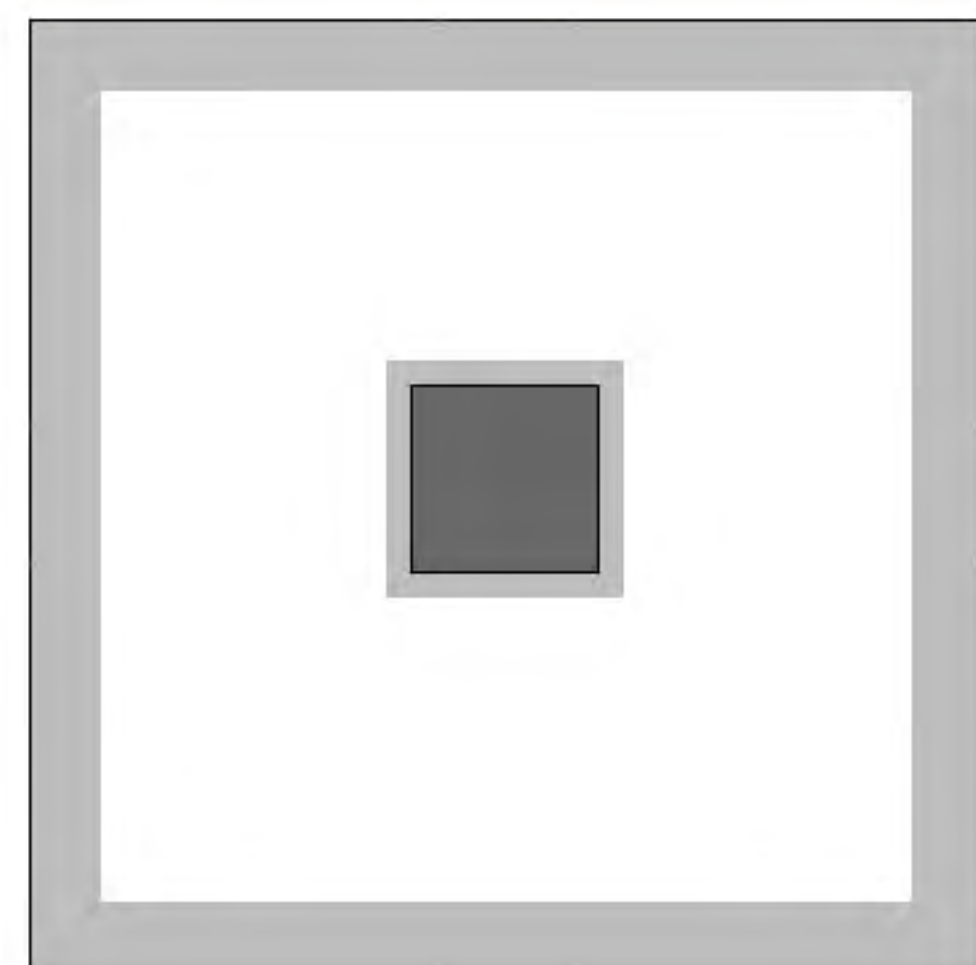

top view (俯视图)

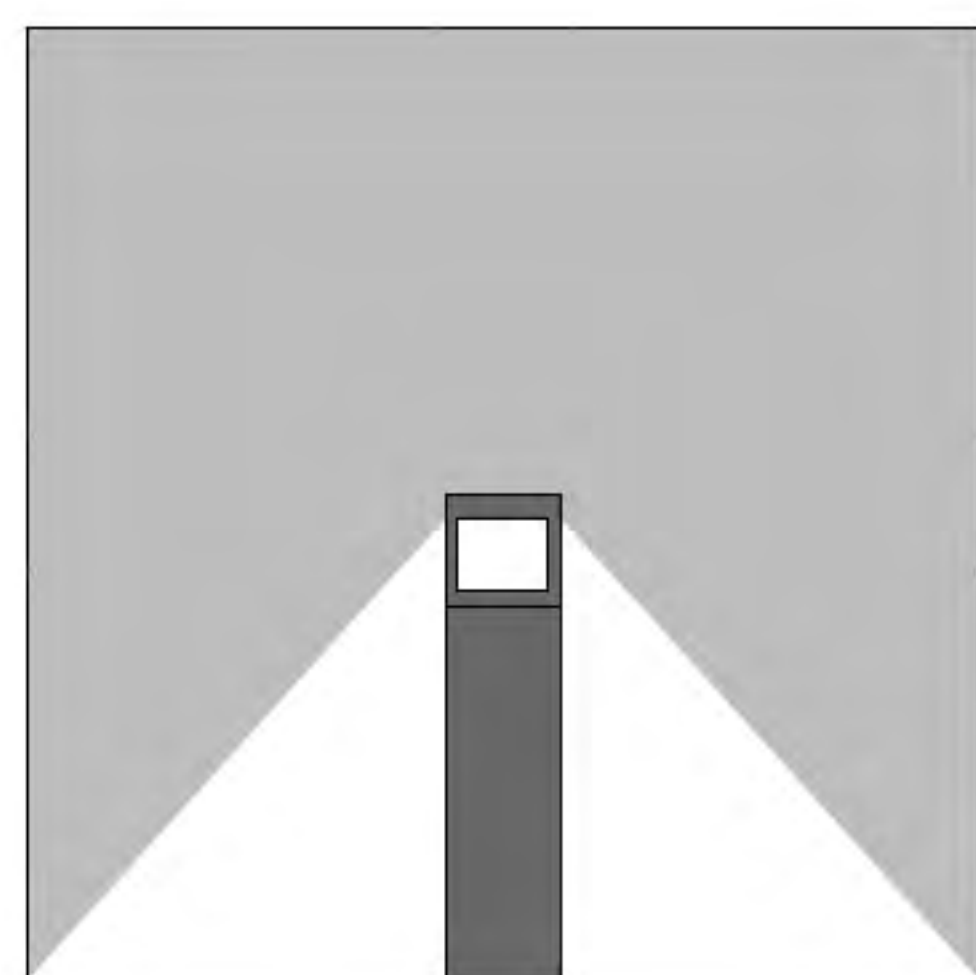

front view (正面图)



## Technical Date (技术参数)

Item No.	Lamp Type	Power	LM	CCT	PF	Voltage	CRI	A	B	C (mm)
MB21-BL11A	LED	12W	840	2700K-6000K	0.6	AC110-265V	80-90	150	100	300
MB21-BL11B	LED	12W	840	2700K-6000K	0.6	AC110-265V	80-90	150	400	600
MB21-BL11C	LED	12W	840	2700K-6000K	0.6	AC110-265V	80-90	150	700	900



# MB21-BL12

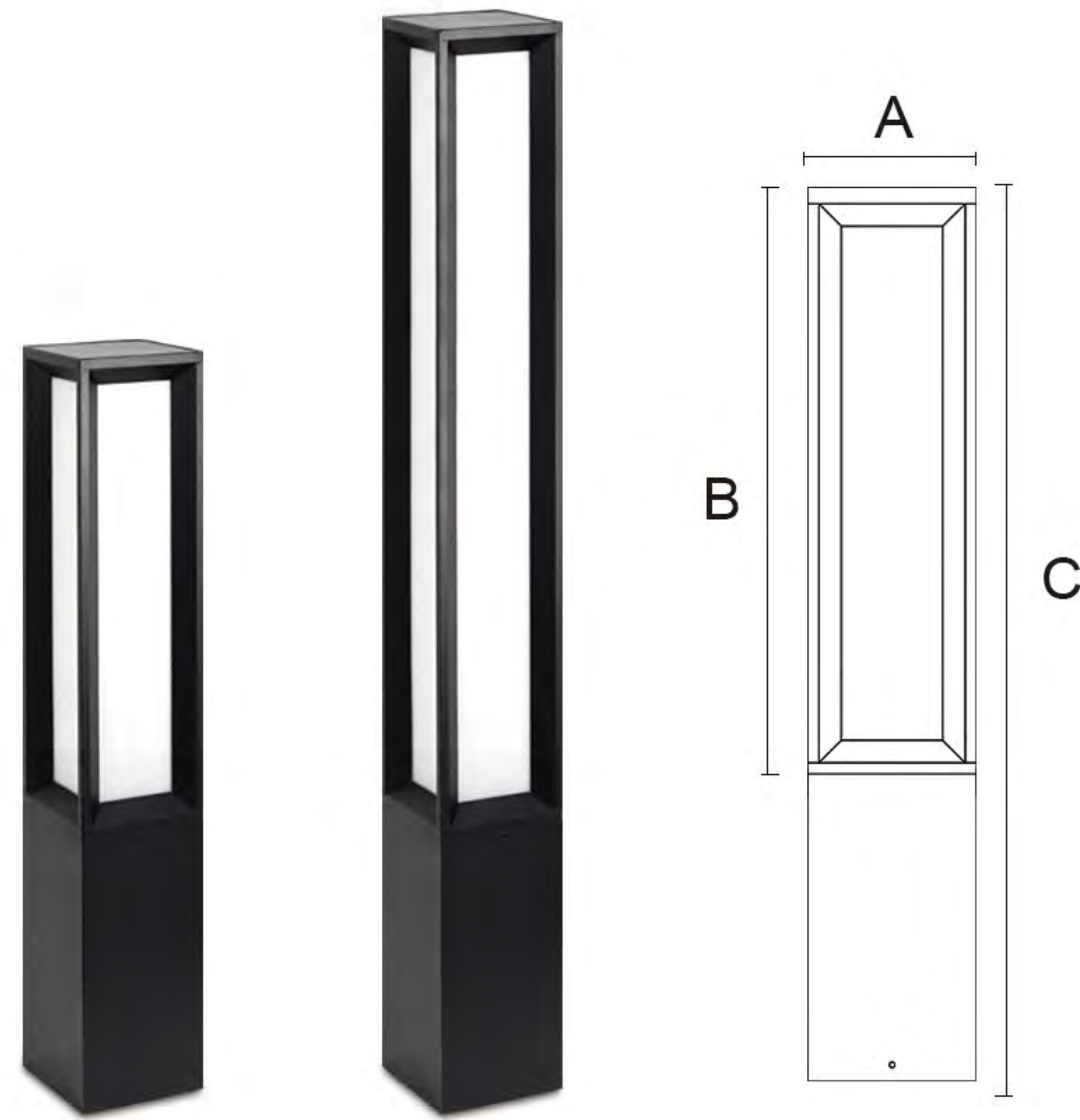

## Features&Benefit (功能和优点)

Category (品类)	Garden Light
Diffuser Material (扩散器材质)	Acrylic
Cover Material (面盖材质)	Aluminum
Operating mode (运行)	Built in
Steuerbar (开关)	On/Off
IP (防水等级)	54
Mounting type (安装类型)	Put
Mounting location (安装位置)	Overground
Application environment (应用环境)	Indoor/Outdoor
Body color (表面颜色)	Black/Dark Gray/Sliver Gray



## Product Description (产品描述)

Suitable for parks and gardens, neighborhoods, villas, city squares, pedestrian streets, scenic spots or resorts and other various scenes; lawn lamps can be a variety of heights at the same time the lighting effect will be different, more to provide a choice.

## Lightmap (光影图)

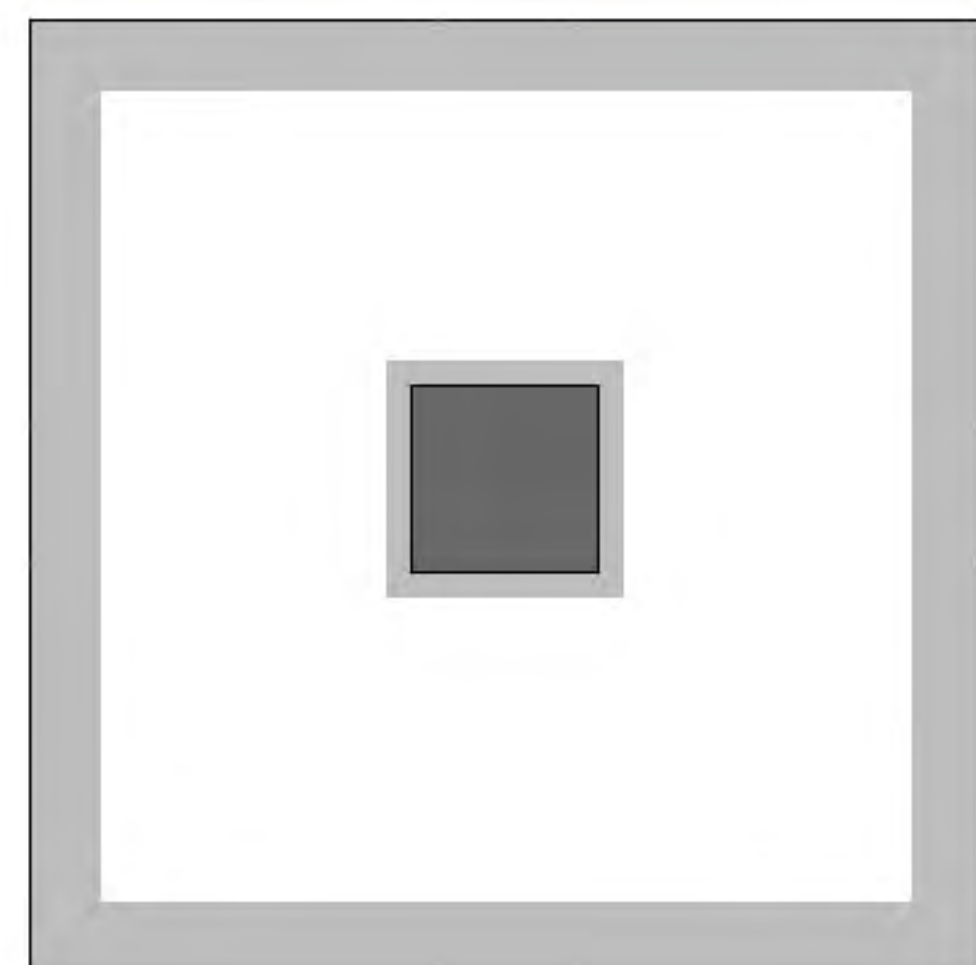

top view (俯视图)

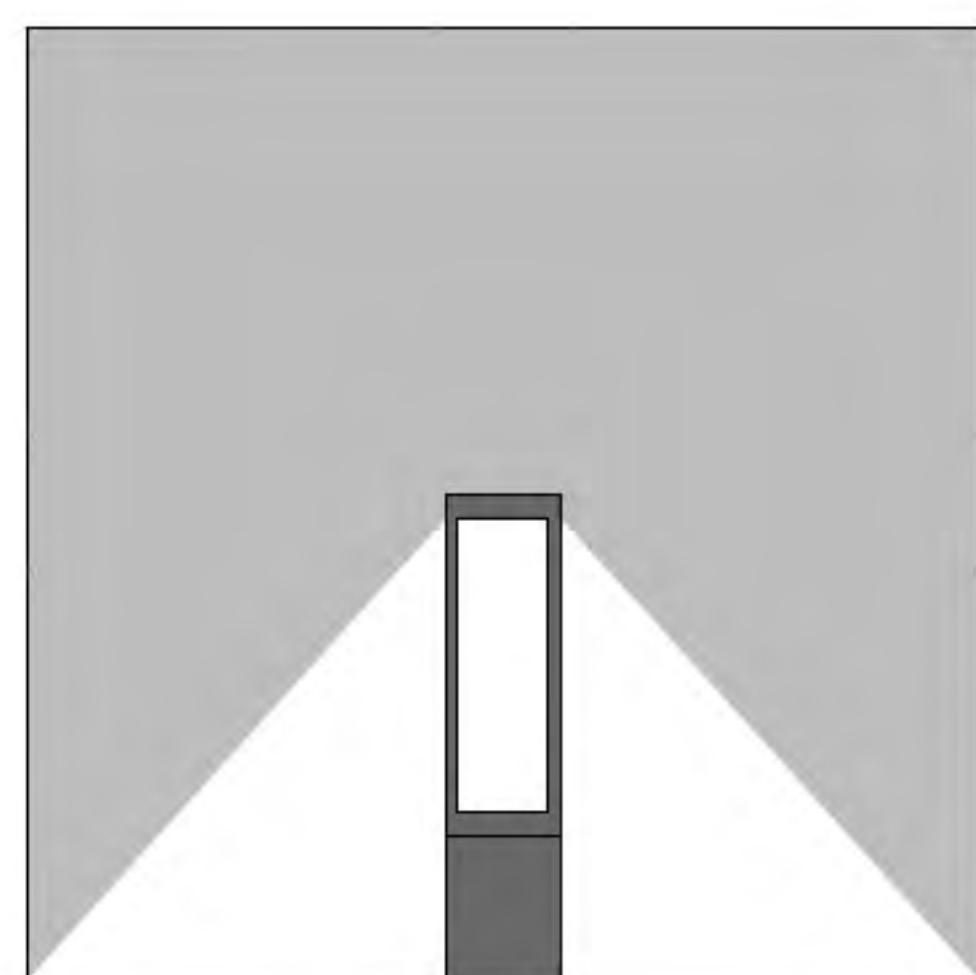

front view (正面图)



## Technical Date (技术参数)

Item No.	Lamp Type	Power	LM	CCT	PF	Voltage	CRI	A	B	C (mm)
MB21-BL12A	LED	20W	1400	2700K-6000K	0.6	AC110-265V	80-90	150	400	600
MB21-BL12B	LED	20W	1400	2700K-6000K	0.6	AC110-265V	80-90	150	700	900



# MB21-BL13

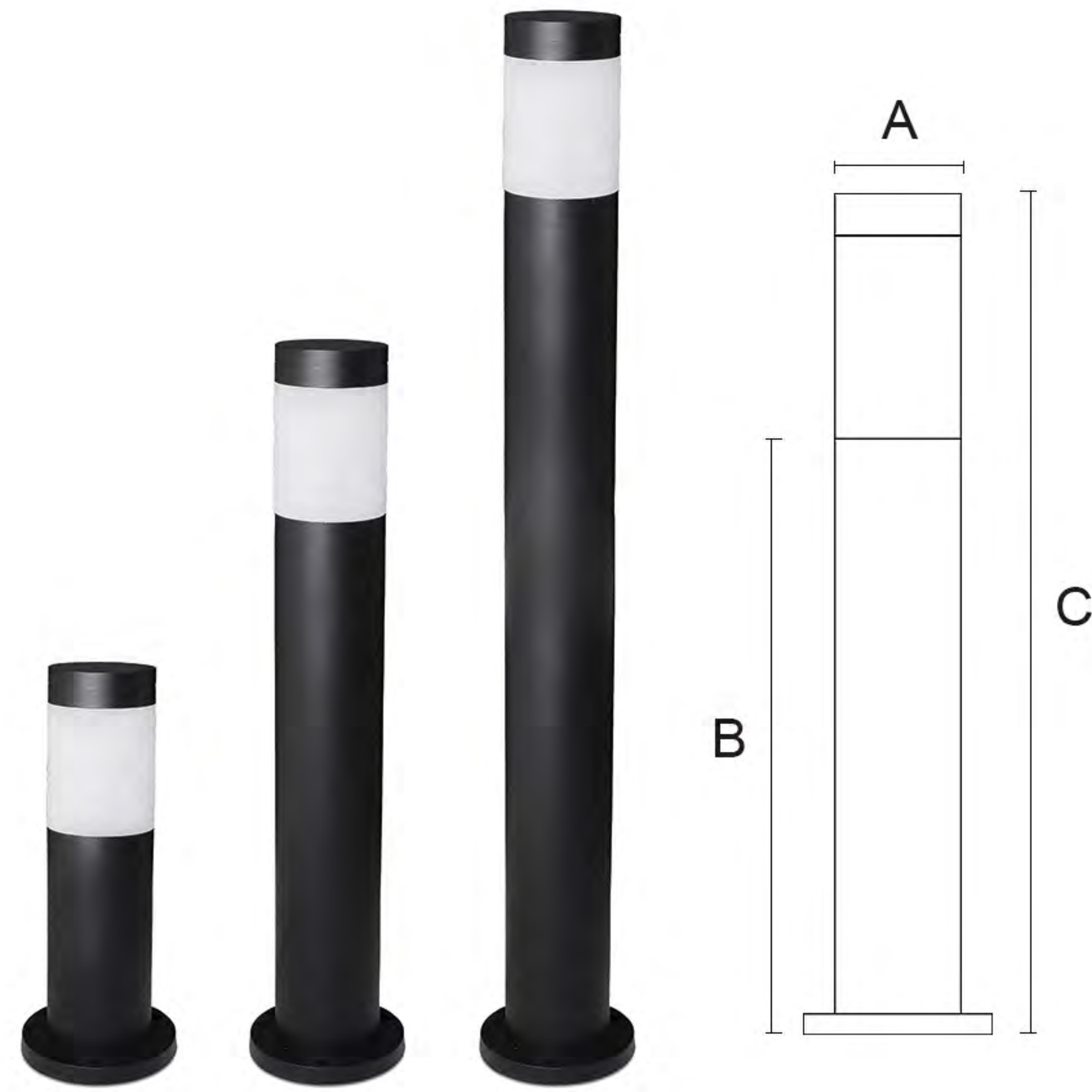

## Features&Benefit (功能和优点)

Category (品类)	Garden Light
Diffuser Material (扩散器材质)	Acrylic
Cover Material (面盖材质)	Aluminum
Operating mode (运行)	Built in
Steuerbar (开关)	On/Off
IP (防水等级)	54
Mounting type (安装类型)	Put
Mounting location (安装位置)	Overground
Application environment (应用环境)	Indoor/Outdoor
Body color (表面颜色)	Black/Dark Gray/Sliver Gray



## Product Description (产品描述)

Suitable for parks and gardens, neighborhoods, villas, city squares, pedestrian streets, scenic spots or resorts and other various scenes; lawn lamps can be a variety of heights at the same time the lighting effect will be different, more to provide a choice.

## Lightmap (光影图)



top view (俯视图)

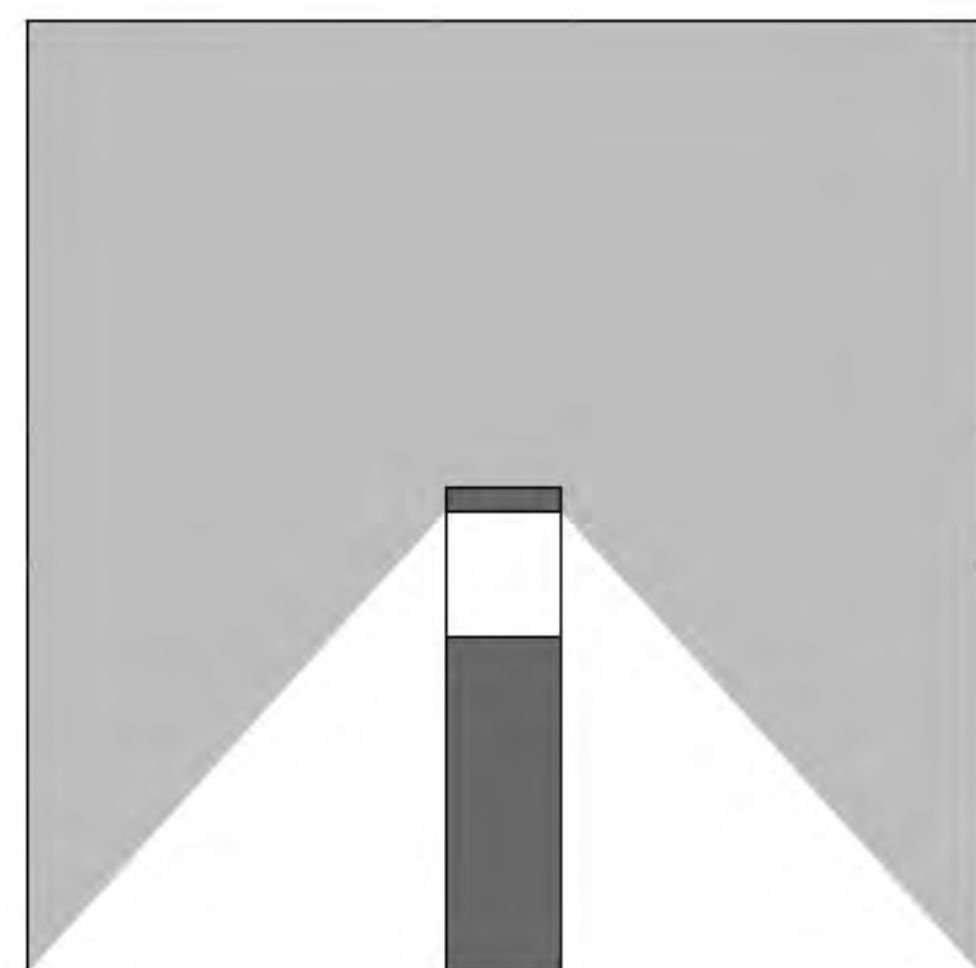

front view (正面图)



## Technical Date (技术参数)

Item No.	Lamp Type	Power	LM	CCT	PF	Voltage	CRI	A	B	C (mm)
MB21-BL13A	LED	7W	490	2700K-6000K	0.6	AC110-265V	80-90	90	165	300
MB21-BL13B	LED	7W	490	2700K-6000K	0.6	AC110-265V	80-90	90	465	600
MB21-BL13C	LED	7W	490	2700K-6000K	0.6	AC110-265V	80-90	90	765	900



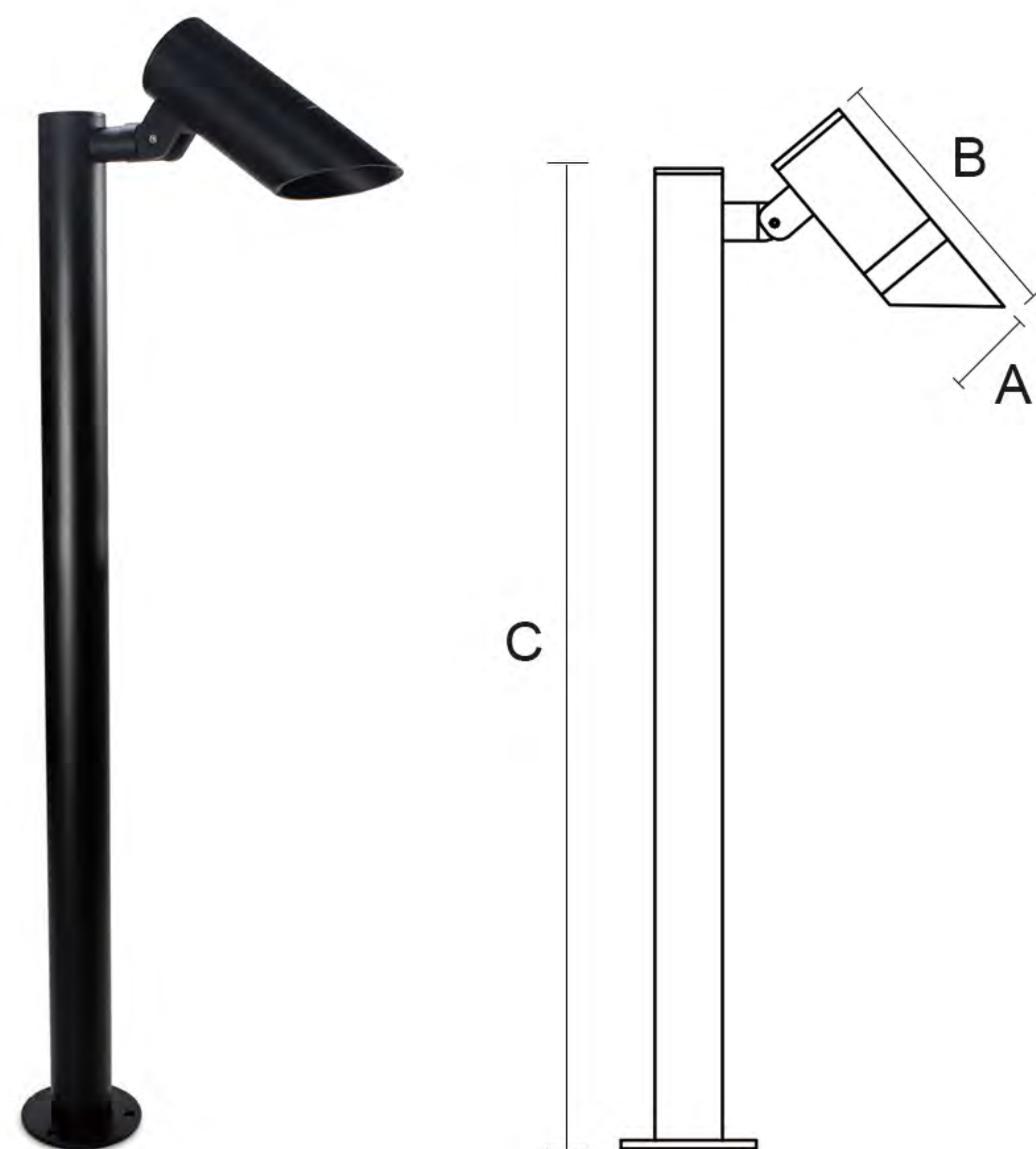

# MB21-BL14

## Features&Benefit (功能和优点)

Category (品类)	Garden Light
Diffuser Material (扩散器材质)	Glass
Cover Material (面盖材质)	Aluminum
Operating made (运行)	Built in
Steuerbar (开关)	On/Off
IP (防水等级)	65
Mounting type (安装类型)	Put
Mounting location (安装位置)	Overground
Application environment (应用环境)	Indoor/Outdoor
Body color (表面颜色)	Black/Dark Gray/Sliver Gray



## Product Description (产品描述)

Suitable for urban slow lane, narrow lanes, residential neighborhoods, tourist attractions, parks, squares, private gardens, courtyard corridors and other public places of the road on one side or both sides of the road lighting; unique design, soft light, so that the scene is full of layers.

## Beam Angle (光束角度)

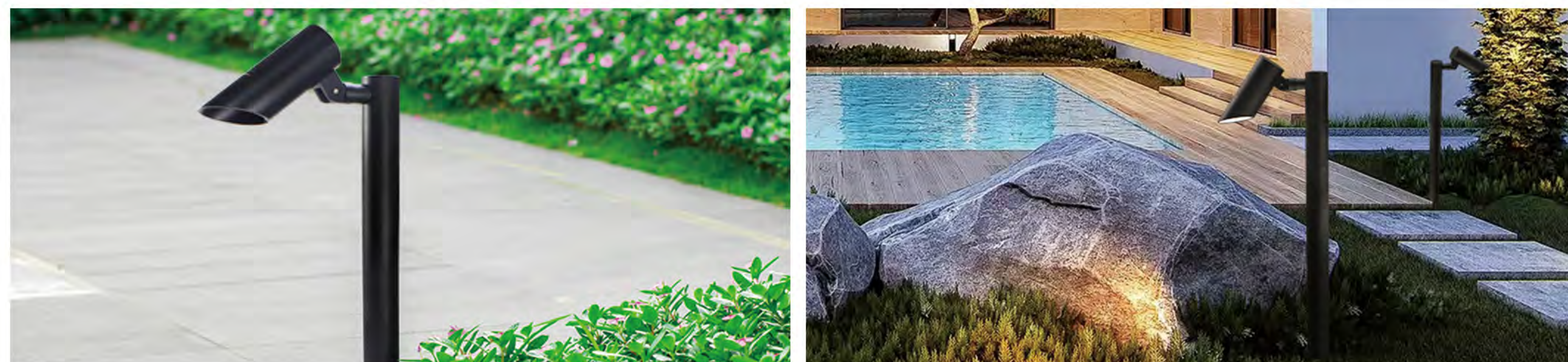
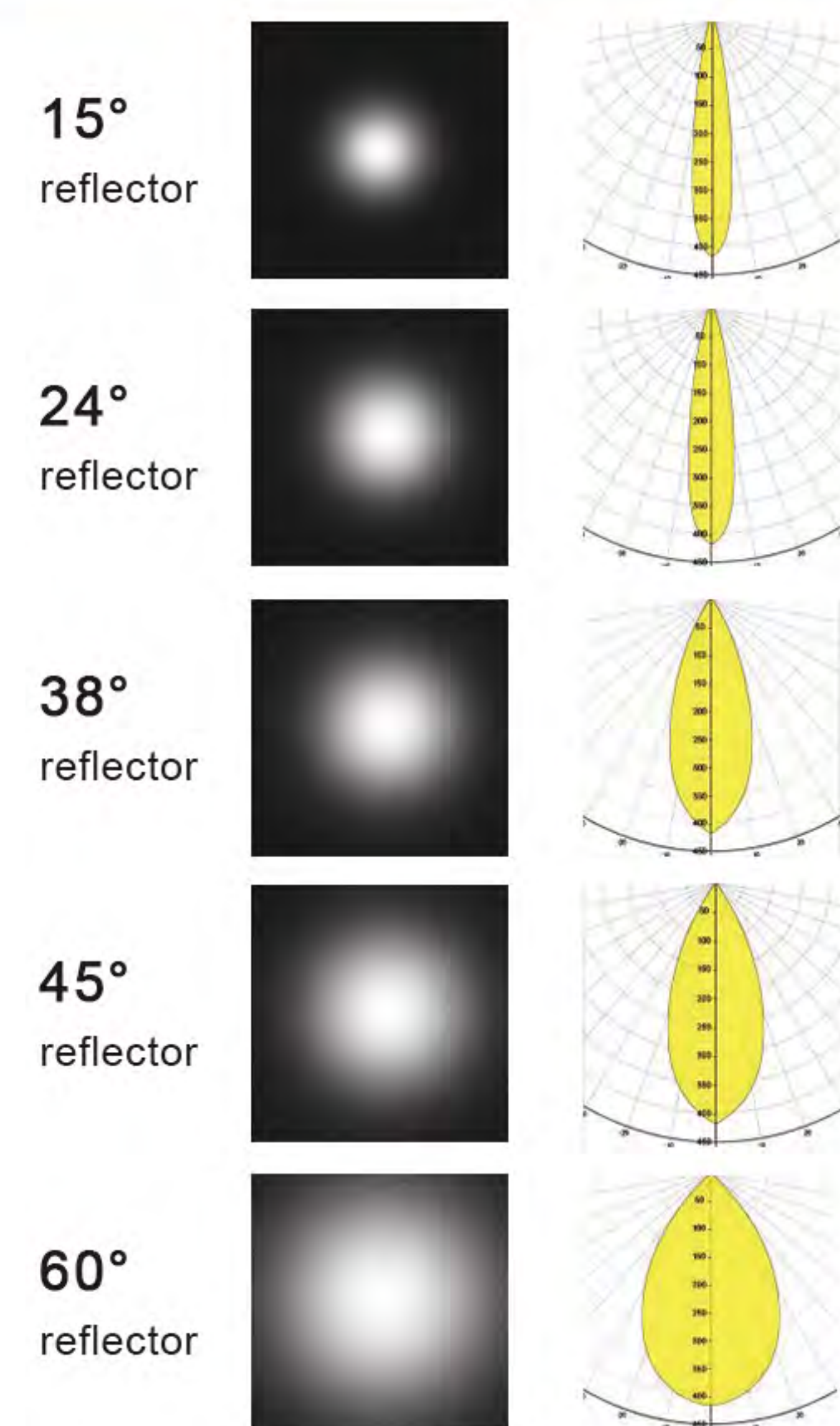

## Technical Date (技术参数)

Item No.	Lamp Type	Power	LM	CCT	PF	Voltage	CRI	A	B	C (mm)
MB21-BL14	LED	10W	700	2700K-6000K	0.6	AC110-265V	80-90	Ø65	183	800
MB21-BL14	GU10/G5.3	-	-	-	-	-	-	Ø65	183	800



# MB21-BL15

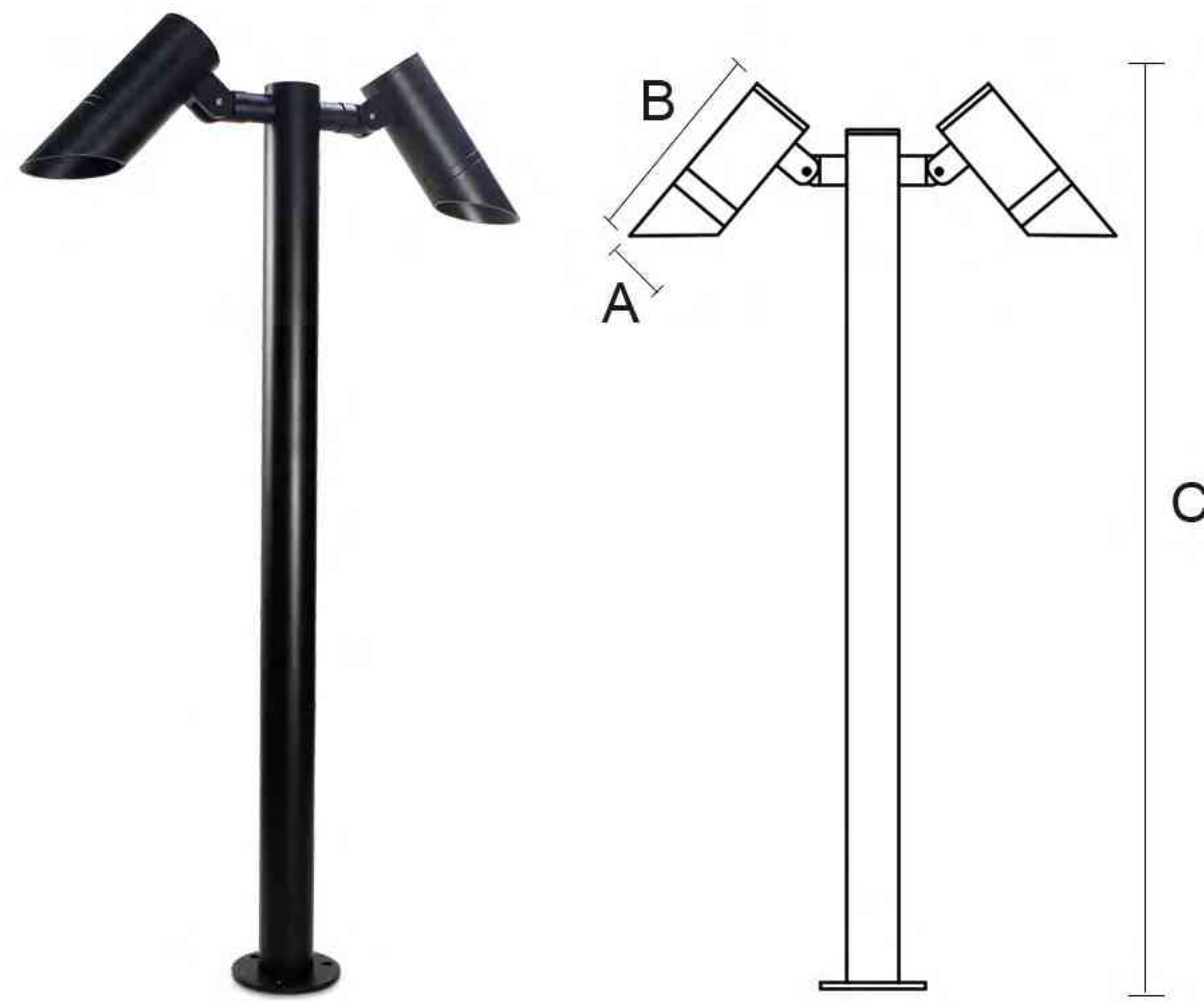

## Features&Benefit (功能和优点)

Category (品类)	Garden Light
Diffuser Material (扩散器材质)	Glass
Cover Material (面盖材质)	Aluminum
Operating made (运行)	Built in
Steuerbar (开关)	On/Off
IP (防水等级)	65
Mounting type (安装类型)	Put
Mounting location (安装位置)	Overground
Application environment (应用环境)	Indoor/Outdoor
Body color (表面颜色)	Black/Dark Gray/Sliver Gray



## Product Description (产品描述)

Suitable for urban slow lane, narrow lanes, residential neighborhoods, tourist attractions, parks, squares, private gardens, courtyard corridors and other public places of the road on one side or both sides of the road lighting; unique design, soft light, so that the scene is full of layers.

## Beam Angle (光束角度)

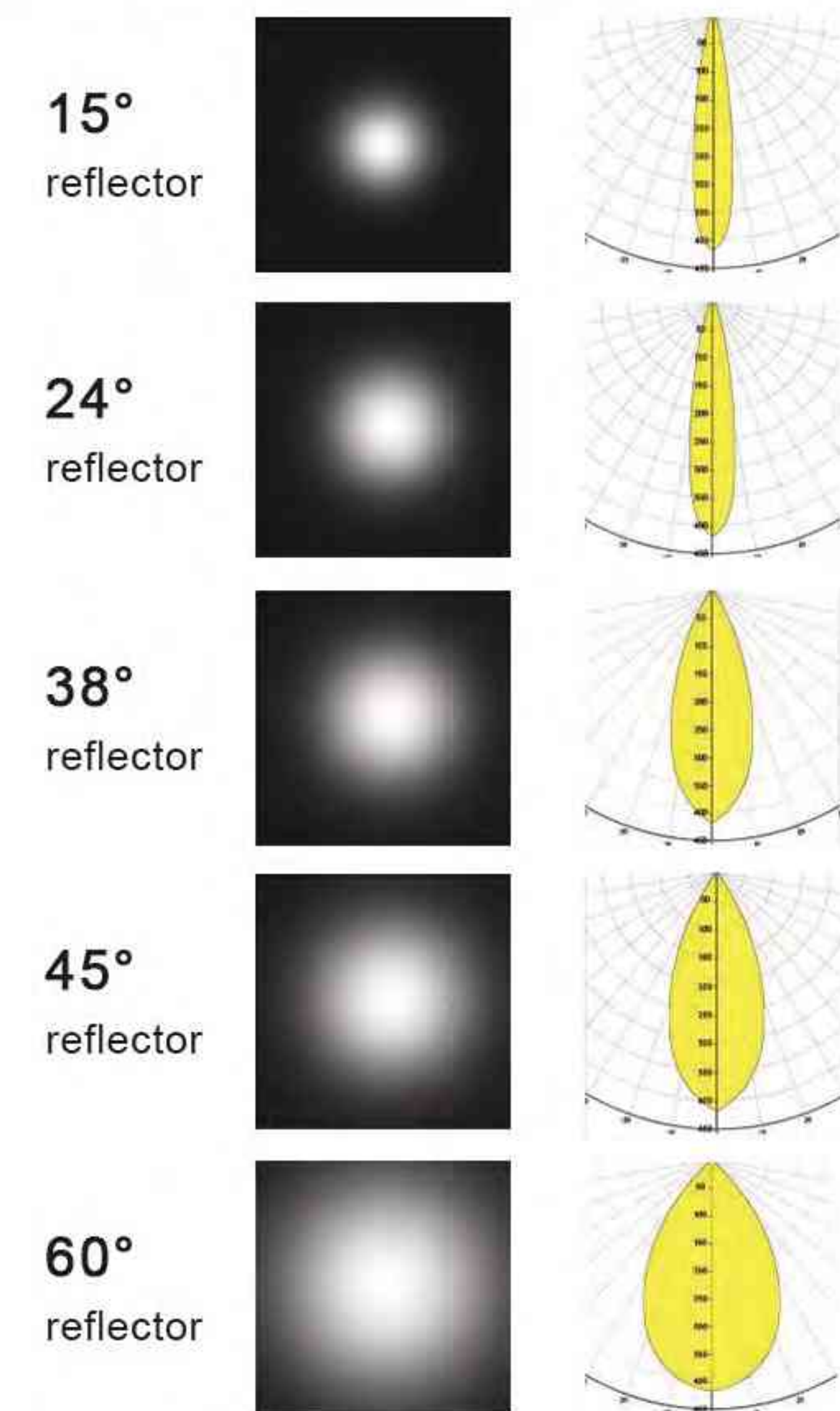

## Technical Date (技术参数)

Item No.	Lamp Type	Power	LM	CCT	PF	Voltage	CRI	A	B	C (mm)
MB21-BL15	LED	2*10W	1400	2700K-6000K	0.6	AC110-265V	80-90	Ø65	183	800
MB21-BL15	GU10/G5.3	-	-	-	-	-	-	Ø65	183	800



# MB21-BL17

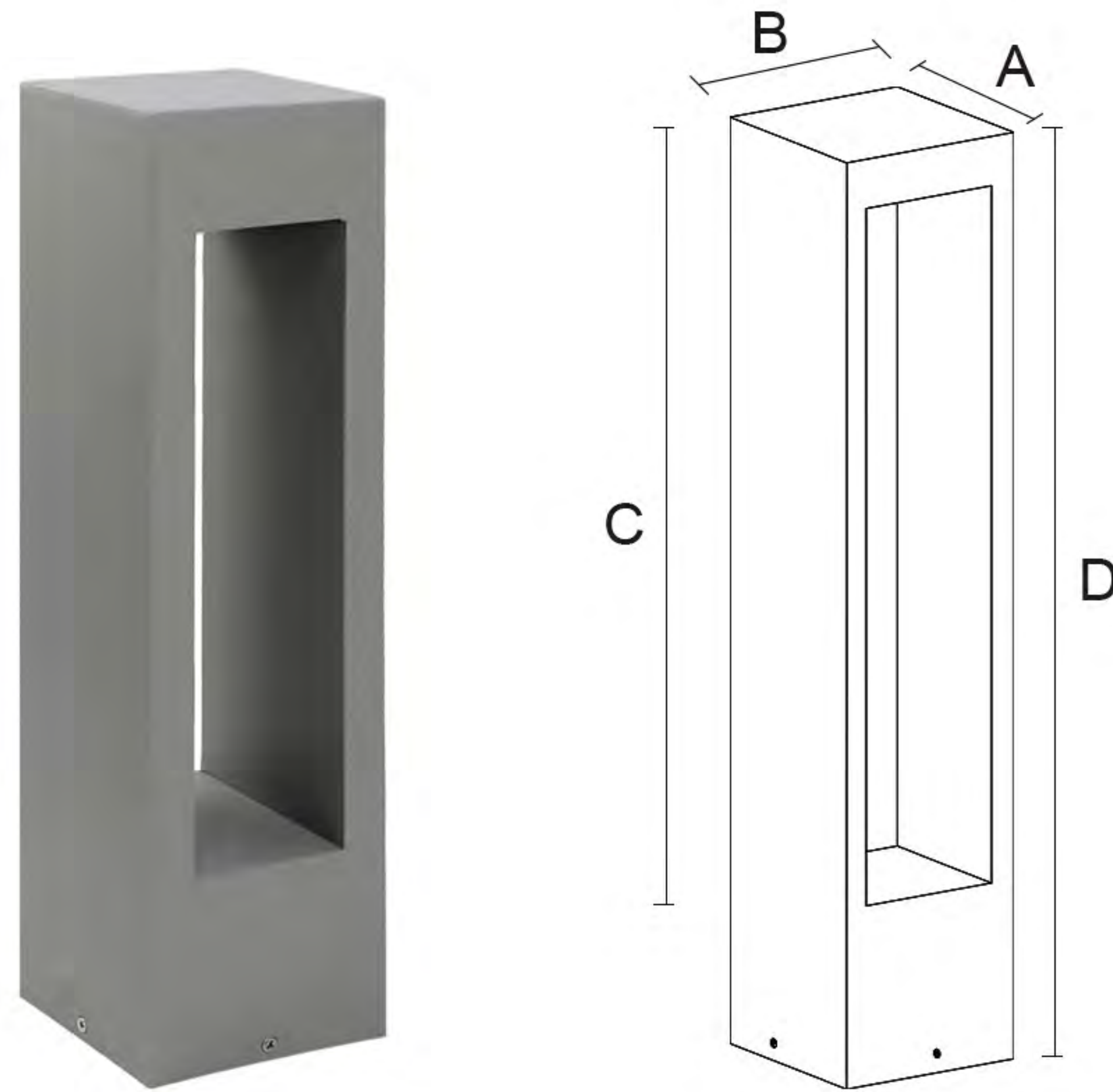

## Features&Benefit (功能和优点)

Category (品类)	Garden Light
Diffuser Material (扩散器材质)	Glass
Cover Material (面盖材质)	Aluminum
Operating mode (运行)	Built in
Steuerbar (开关)	On/Off
IP (防水等级)	54
Mounting type (安装类型)	Put
Mounting location (安装位置)	Overground
Application environment (应用环境)	Indoor/Outdoor
Body color (表面颜色)	Black/Dark Gray/Sliver Gray



## Product Description (产品描述)

Suitable for urban slow lane, narrow lanes, residential neighborhoods, tourist attractions, parks, squares, private gardens, courtyard corridors and other public places of the road on one side or both sides of the road lighting; unique design, soft light, so that the scene is full of layers.

## Lightmap (光影图)

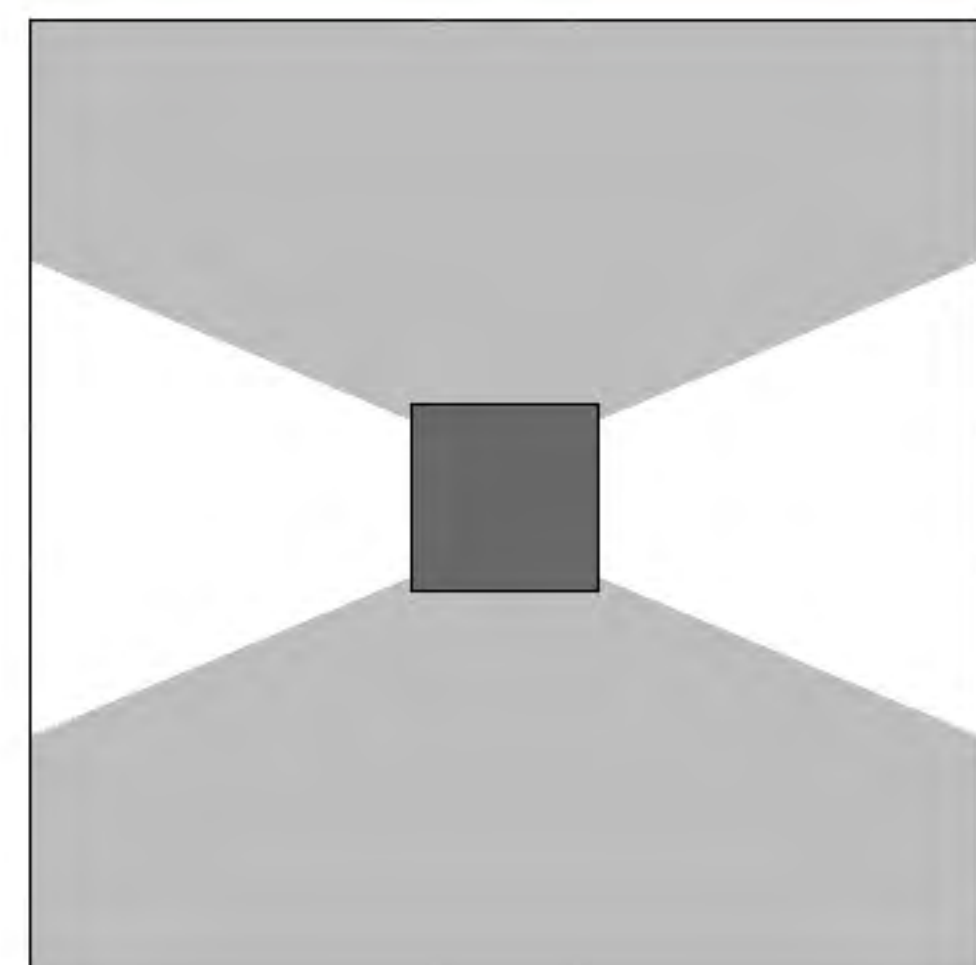

top view (俯视图)

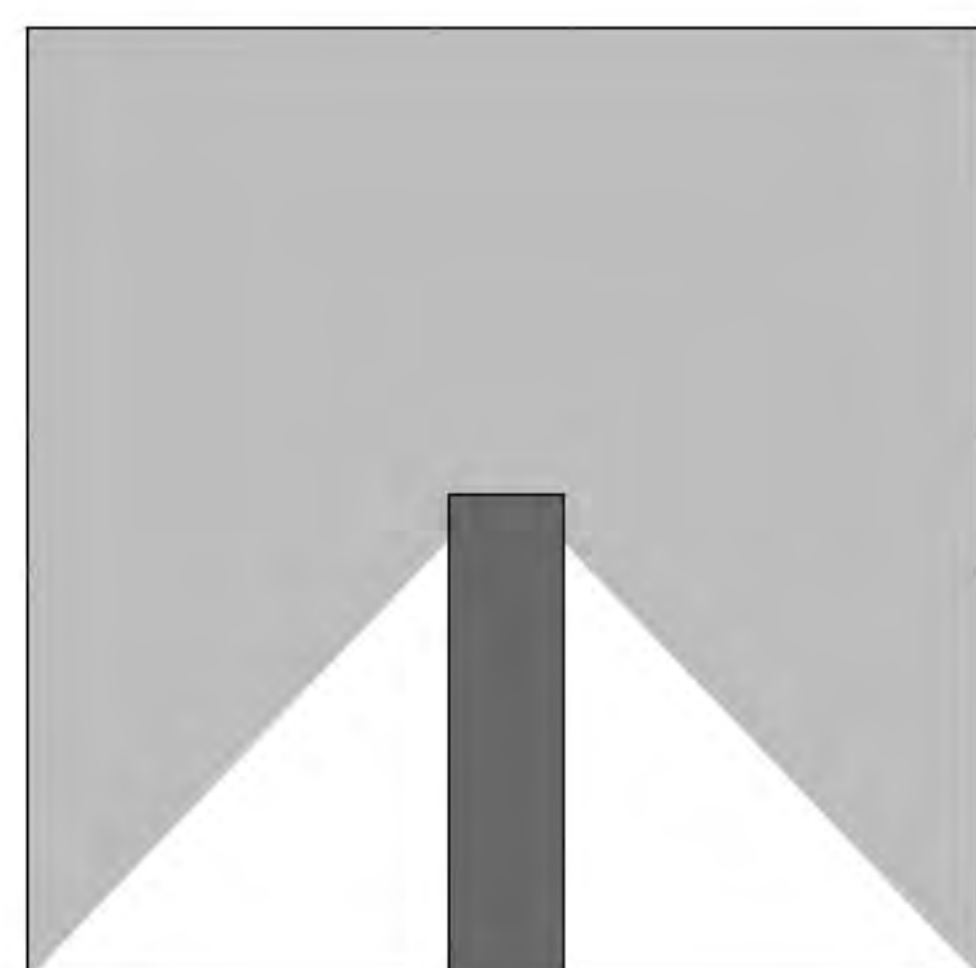

front view (正面图)



## Technical Date (技术参数)

Item No.	Lamp Type	Power	LM	CCT	PF	Voltage	CRI	A	B	C	D (mm)
MB21-BL17/120A	LED	10W	700	2700K-6000K	0.6	AC110-265V	80-90	120	120	300	500
MB21-BL17/120B	LED	10W	700	2700K-6000K	0.6	AC110-265V	80-90	120	120	600	800
MB21-BL17/150A	LED	10W	700	2700K-6000K	0.6	AC110-265V	80-90	150	150	300	500
MB21-BL17/150B	LED	10W	700	2700K-6000K	0.6	AC110-265V	80-90	150	150	600	800
MB21-BL17/200A	LED	10W	700	2700K-6000K	0.6	AC110-265V	80-90	200	200	300	500
MB21-BL17/200B	LED	10W	700	2700K-6000K	0.6	AC110-265V	80-90	200	200	600	800



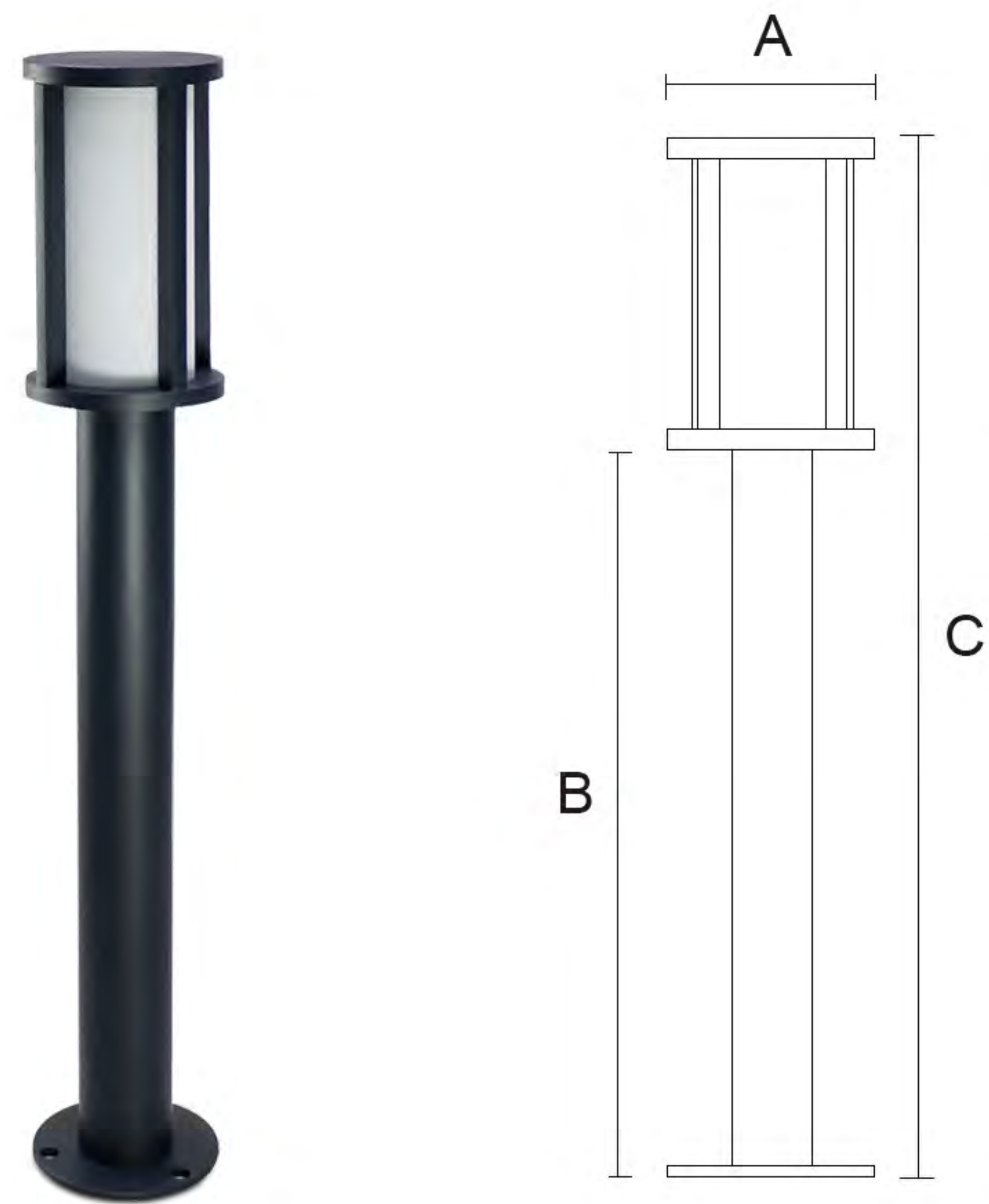

# MB21-BL19

## Features&Benefit (功能和优点)

Category (品类)	Garden Light
Diffuser Material (扩散器材质)	Acrylic
Cover Material (面盖材质)	Aluminum
Operating made (运行)	Built in
Steuerbar (开关)	On/Off
IP (防水等级)	54
Mounting type (安装类型)	Put
Mounting location (安装位置)	Overground
Application environment (应用环境)	Indoor/Outdoor
Body color (表面颜色)	Black/Dark Gray/Sliver Gray



## Product Description (产品描述)

Suitable for urban slow lane, narrow lanes, residential neighborhoods, tourist attractions, parks, squares, private gardens, courtyard corridors and other public places of the road on one side or both sides of the road lighting; unique design, soft light, so that the scene is full of layers.

## Lightmap (光影图)



top view (俯视图)

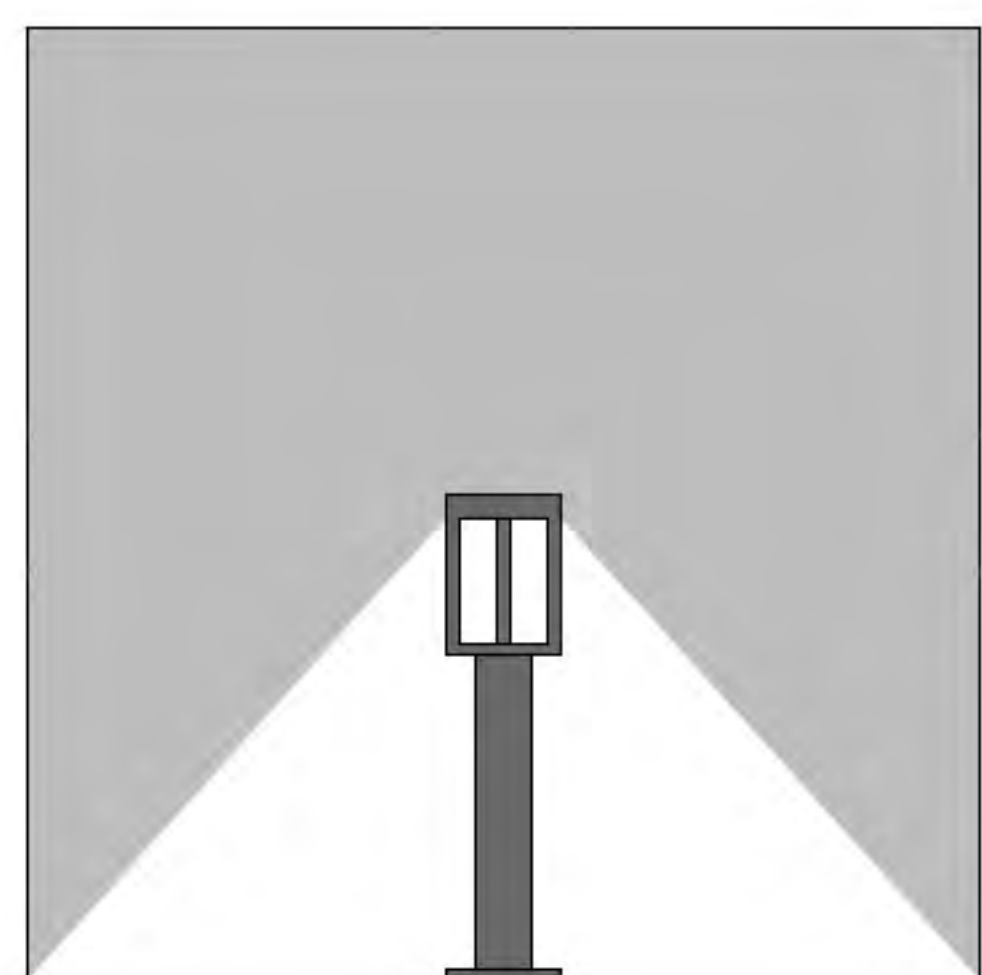

front view (正面图)



## Technical Date (技术参数)

Item No.	Lamp Type	Power	LM	CCT	PF	Voltage	CRI	A	B	C (mm)
MB21-BL19	LED	7W	490	2700K-6000K	0.6	AC110-265V	80-90	Ø100	630	800



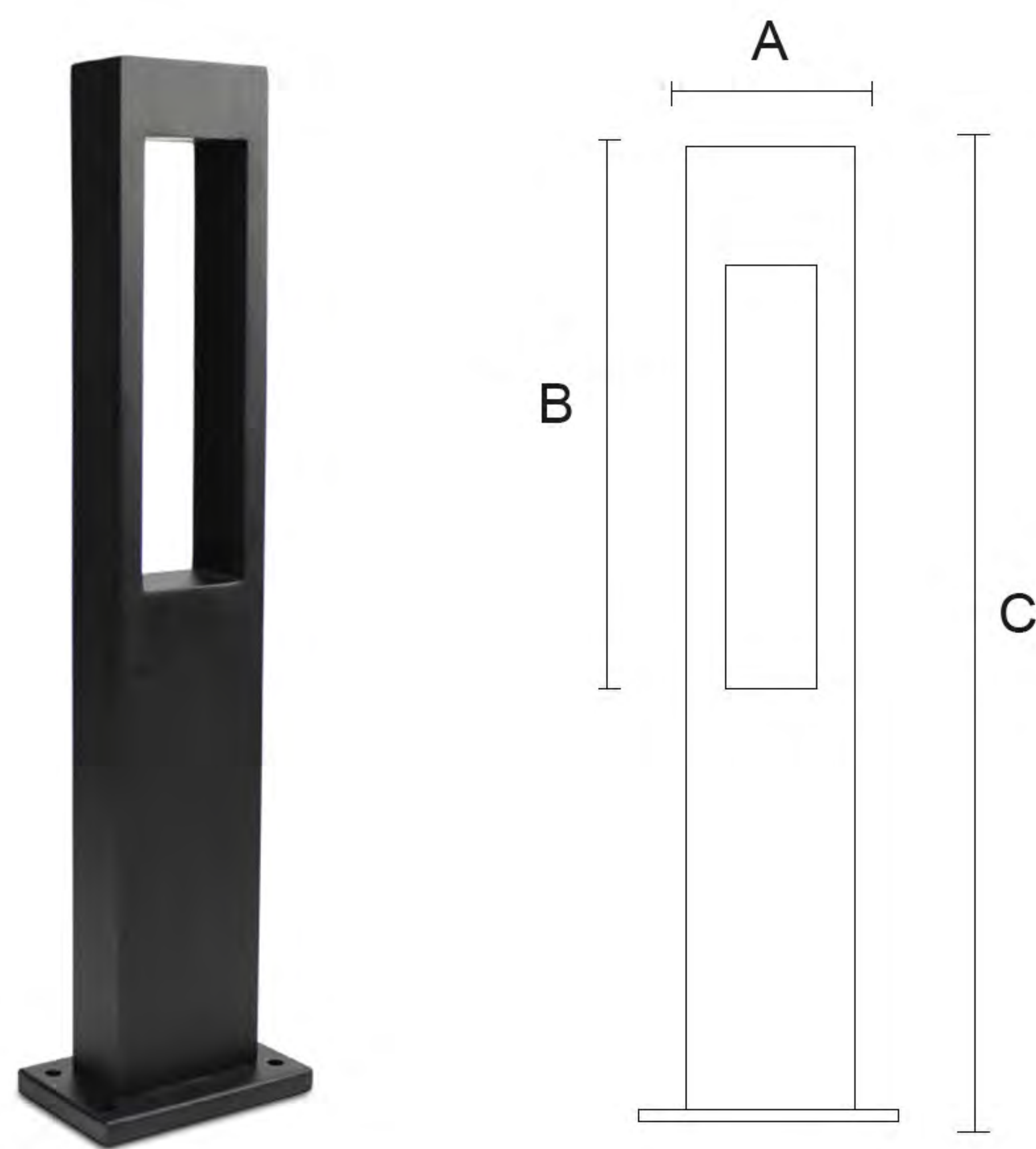

# MB21-BL20

## Features&Benefit (功能和优点)

Category (品类)	Garden Light
Diffuser Material (扩散器材质)	Glass
Cover Material (面盖材质)	Aluminum
Operating mode (运行)	Built in
Steuerbar (开关)	On/Off
IP (防水等级)	54
Mounting type (安装类型)	Put
Mounting location (安装位置)	Overground
Application environment (应用环境)	Indoor/Outdoor
Body color (表面颜色)	Black/Dark Gray/Sliver Gray



## Product Description (产品描述)

Suitable for urban slow lane, narrow lanes, residential neighborhoods, tourist attractions, parks, squares, private gardens, courtyard corridors and other public places of the road on one side or both sides of the road lighting; unique design, soft light, so that the scene is full of layers.

## Lightmap (光影图)

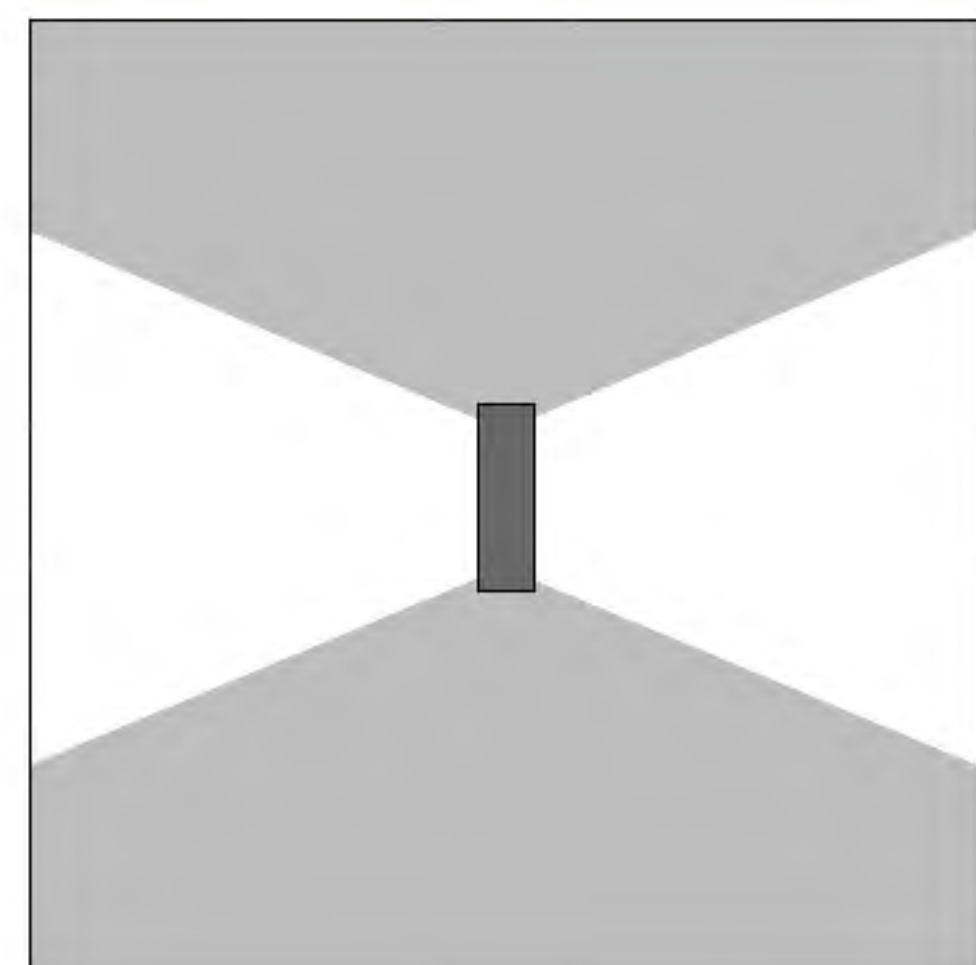

top view (俯视图)

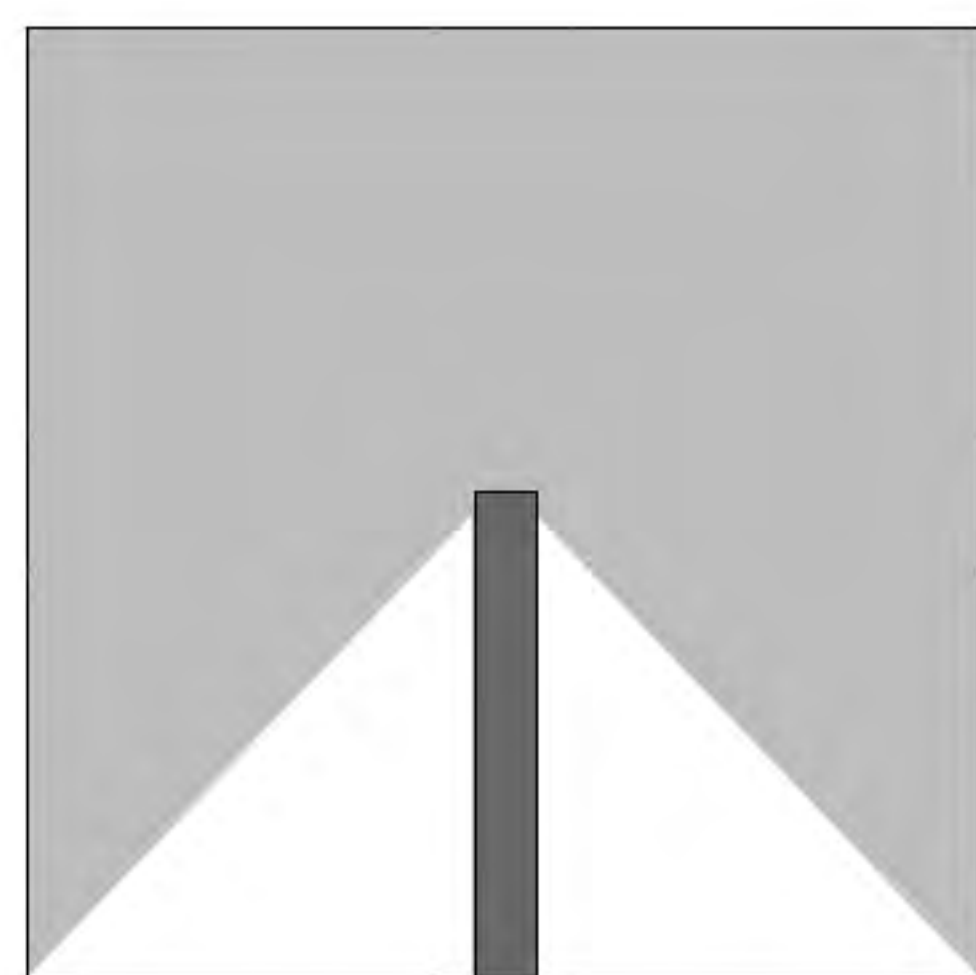

front view (正面图)



## Technical Date (技术参数)

Item No.	Lamp Type	Power	LM	CCT	PF	Voltage	CRI	A	B	C (mm)
MB21-BL20	LED	7W	490	2700K-6000K	0.6	AC110-265V	80-90	100	290	600



# MB21-BL21

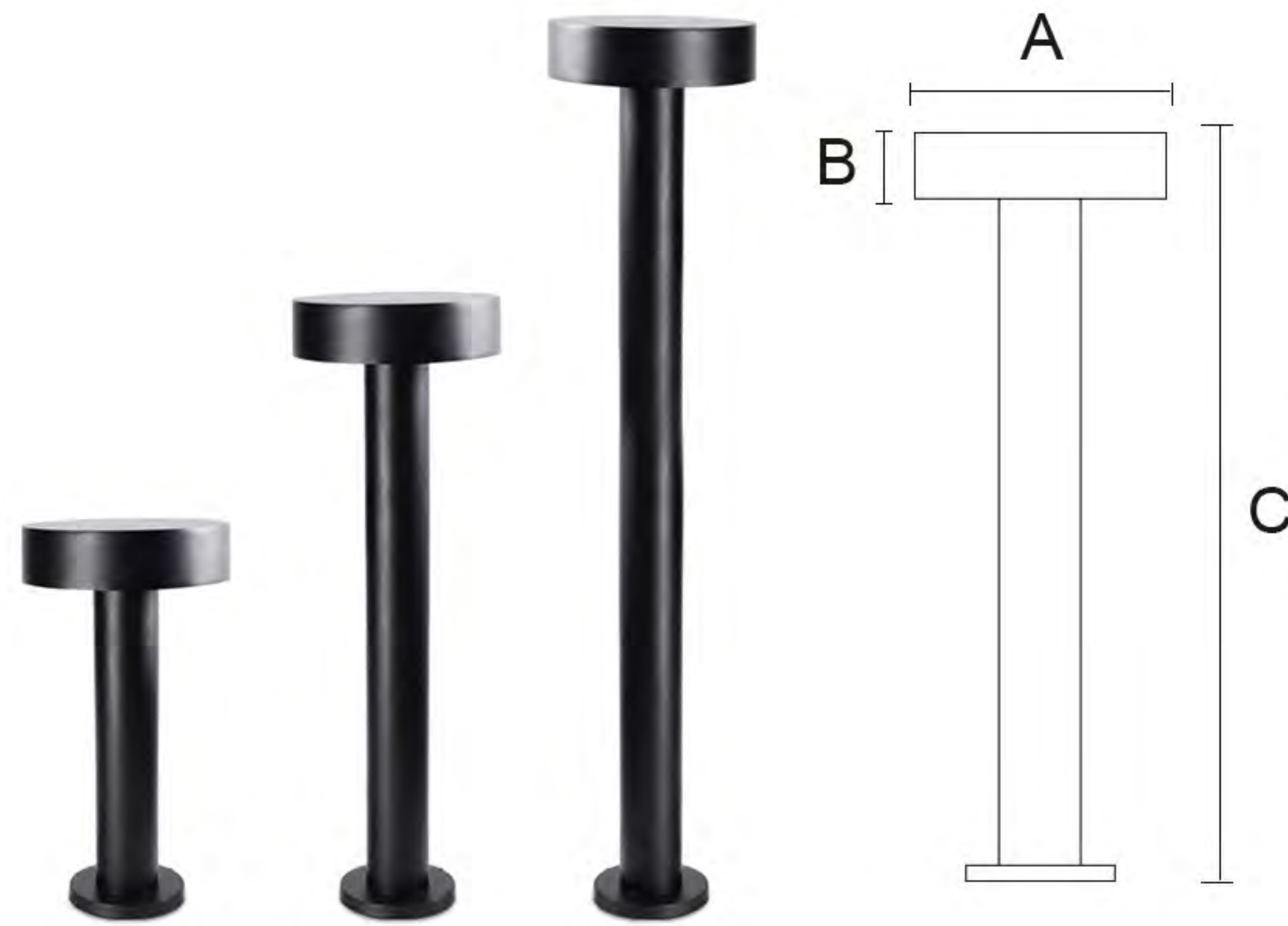

## Features&Benefit (功能和优点)

Category (品类)	Garden Light
Diffuser Material (扩散器材质)	PC
Cover Material (面盖材质)	Aluminum
Operating mode (运行)	Built in
Steuerbar (开关)	On/Off
IP (防水等级)	54
Mounting type (安装类型)	Put
Mounting location (安装位置)	Overground
Application environment (应用环境)	Indoor/Outdoor
Body color (表面颜色)	Black/Dark Gray/Sliver Gray



## Product Description (产品描述)

Suitable for urban slow lane, narrow lanes, residential neighborhoods, tourist attractions, parks, squares, private gardens, courtyard corridors and other public places of the road on one side or both sides of the road lighting; unique design, soft light, so that the scene is full of layers.

## Lightmap (光影图)



top view (俯视图)

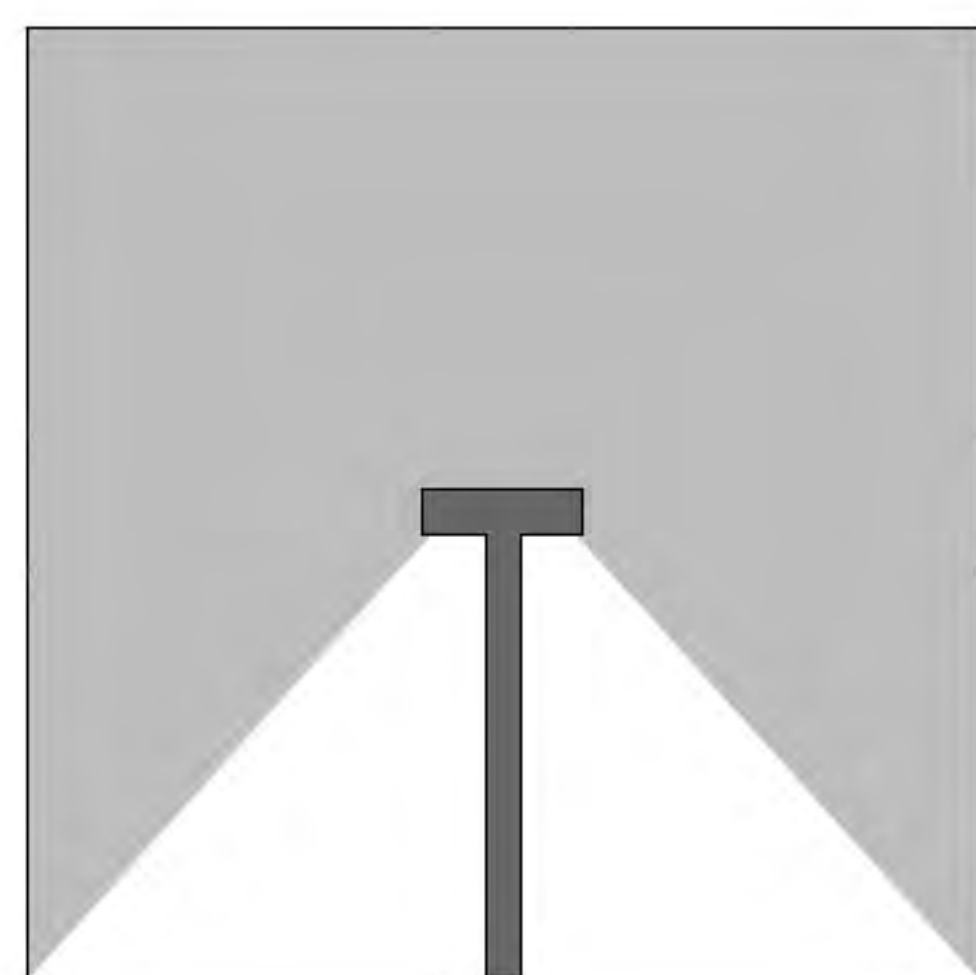

front view (正面图)

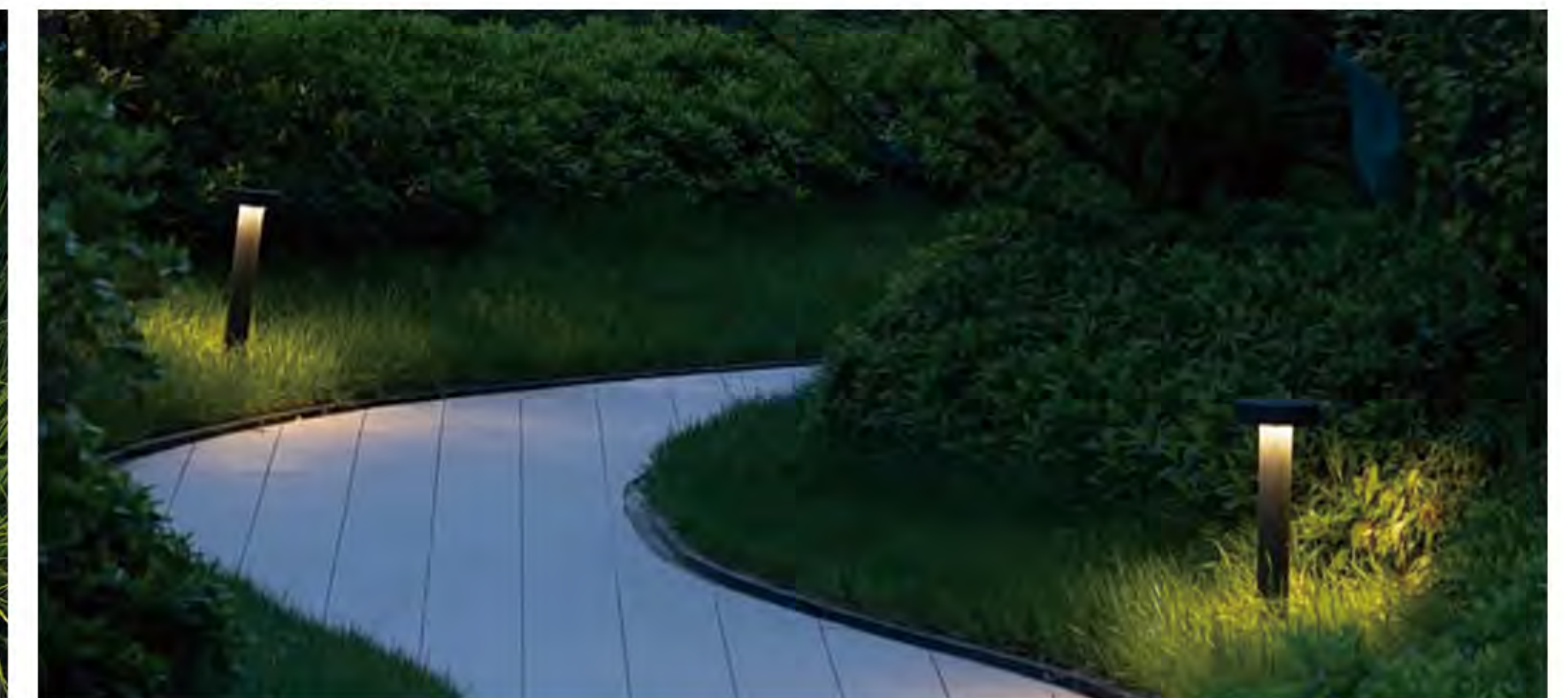

## Technical Date (技术参数)

Item No.	Lamp Type	Power	LM	CCT	PF	Voltage	CRI	A	B	C (mm)
MB21-BL21A	LED	12W	840	2700K-6000K	0.6	AC110-265V	80-90	Ø200	55	400
MB21-BL21B	LED	12W	840	2700K-6000K	0.6	AC110-265V	80-90	Ø200	55	600
MB21-BL21C	LED	12W	840	2700K-6000K	0.6	AC110-265V	80-90	Ø200	55	900



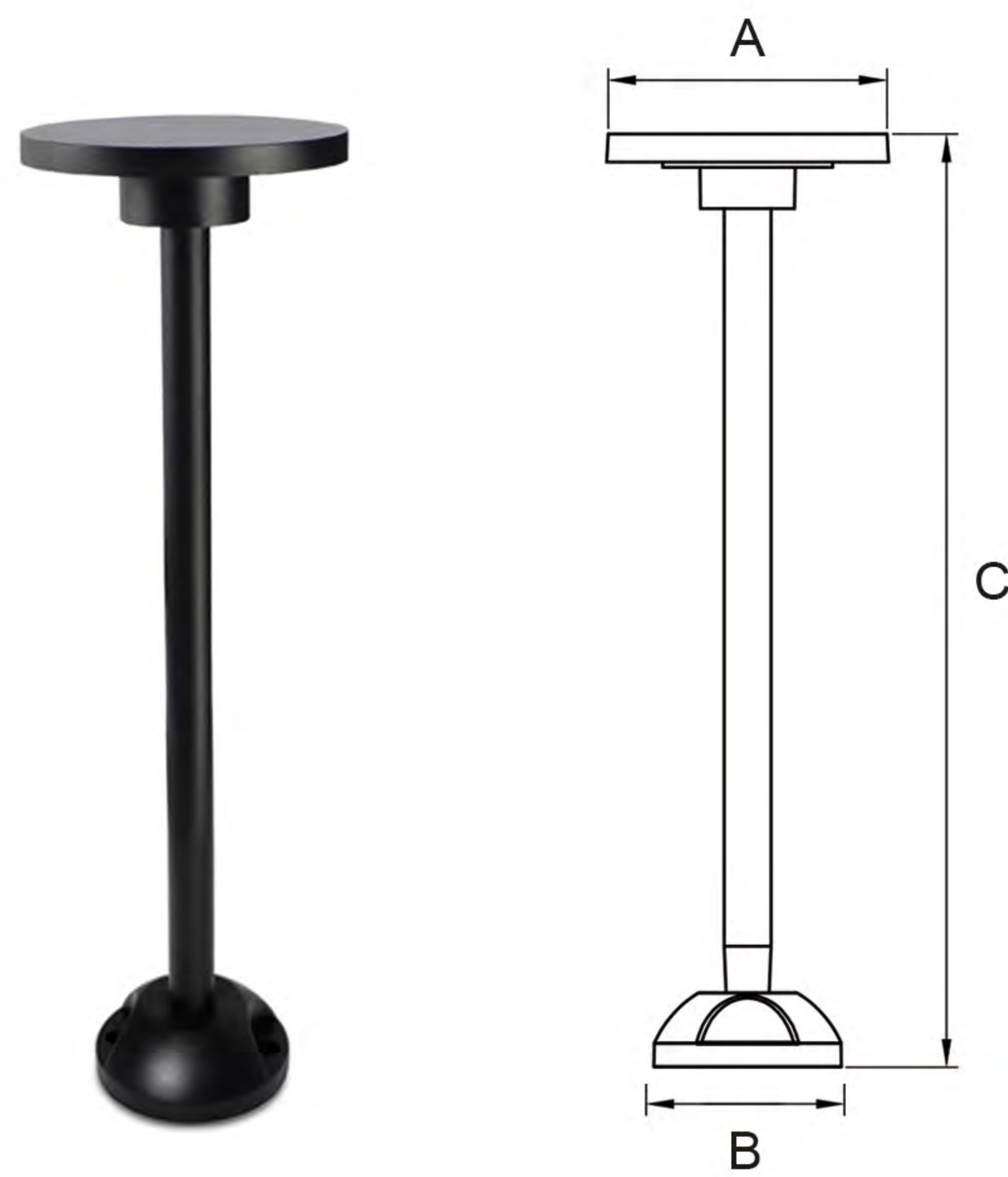

# MB21-BL22

## Features&Benefit (功能和优点)

Category (品类)	Garden Light
Diffuser Material (扩散器材质)	PC
Cover Material (面盖材质)	Aluminum
Operating mode (运行)	Built in
Steuerbar (开关)	On/Off
IP (防水等级)	54
Mounting type (安装类型)	Put
Mounting location (安装位置)	Overground
Application environment (应用环境)	Indoor/Outdoor
Body color (表面颜色)	Black/Dark Gray/Sliver Gray



## Product Description (产品描述)

Suitable for urban slow lane, narrow lanes, residential neighborhoods, tourist attractions, parks, squares, private gardens, courtyard corridors and other public places of the road on one side or both sides of the road lighting; unique design, soft light, so that the scene is full of layers.

## Lightmap (光影图)

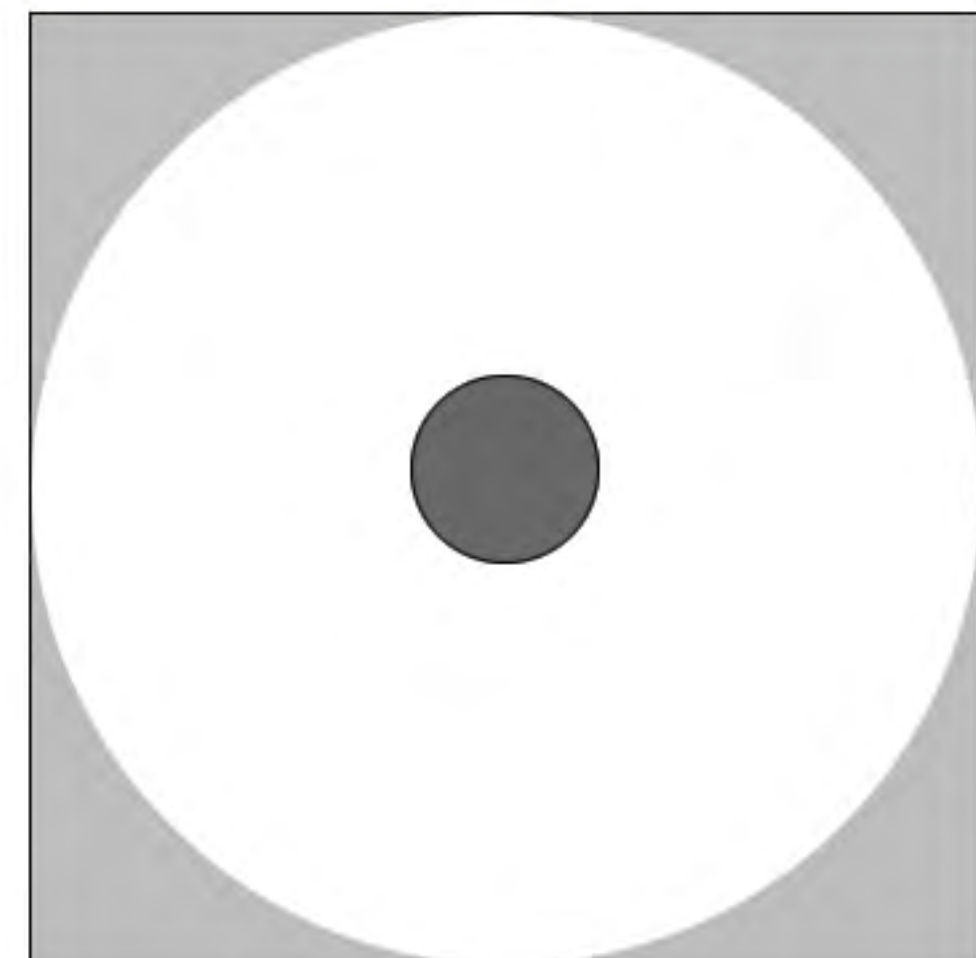

top view (俯视图)

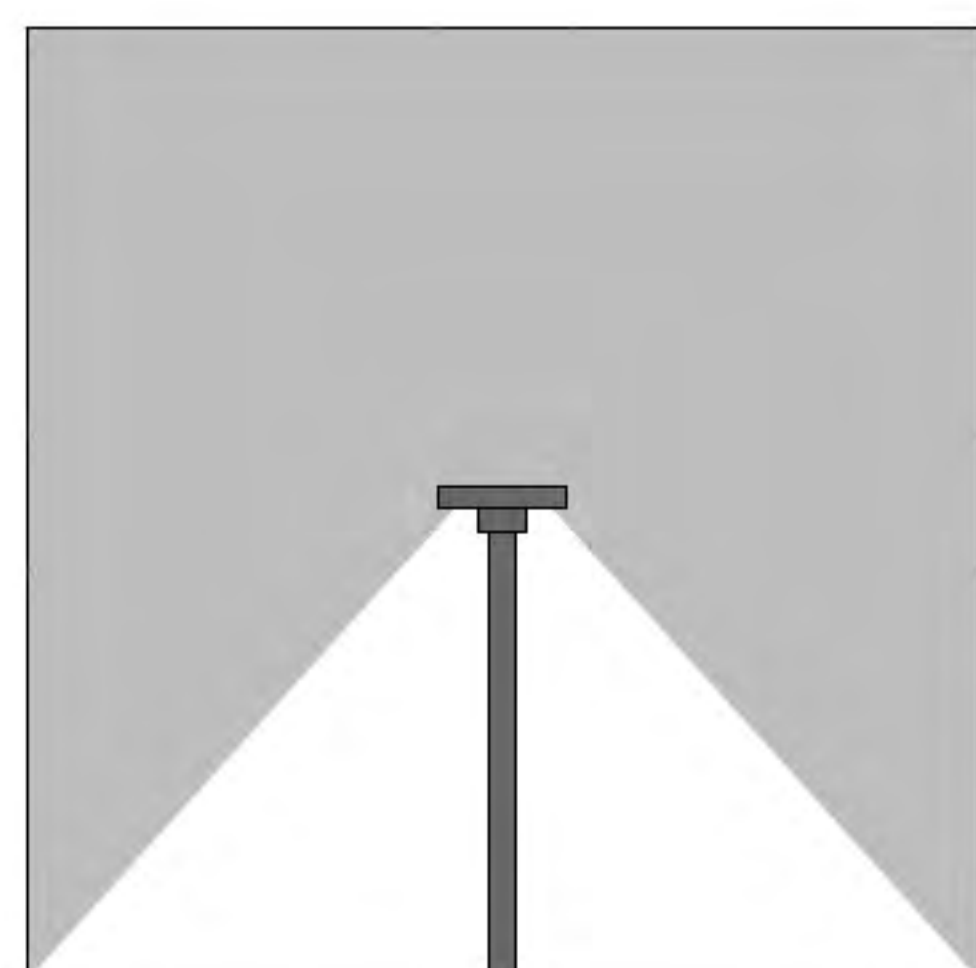

front view (正面图)



## Technical Date (技术参数)

Item No.	Lamp Type	Power	LM	CCT	PF	Voltage	CRI	A	B	C (mm)
MB21-BL22	LED	10W	700	2700K-6000K	0.6	AC110-265V	80-90	Ø150	Ø100	500



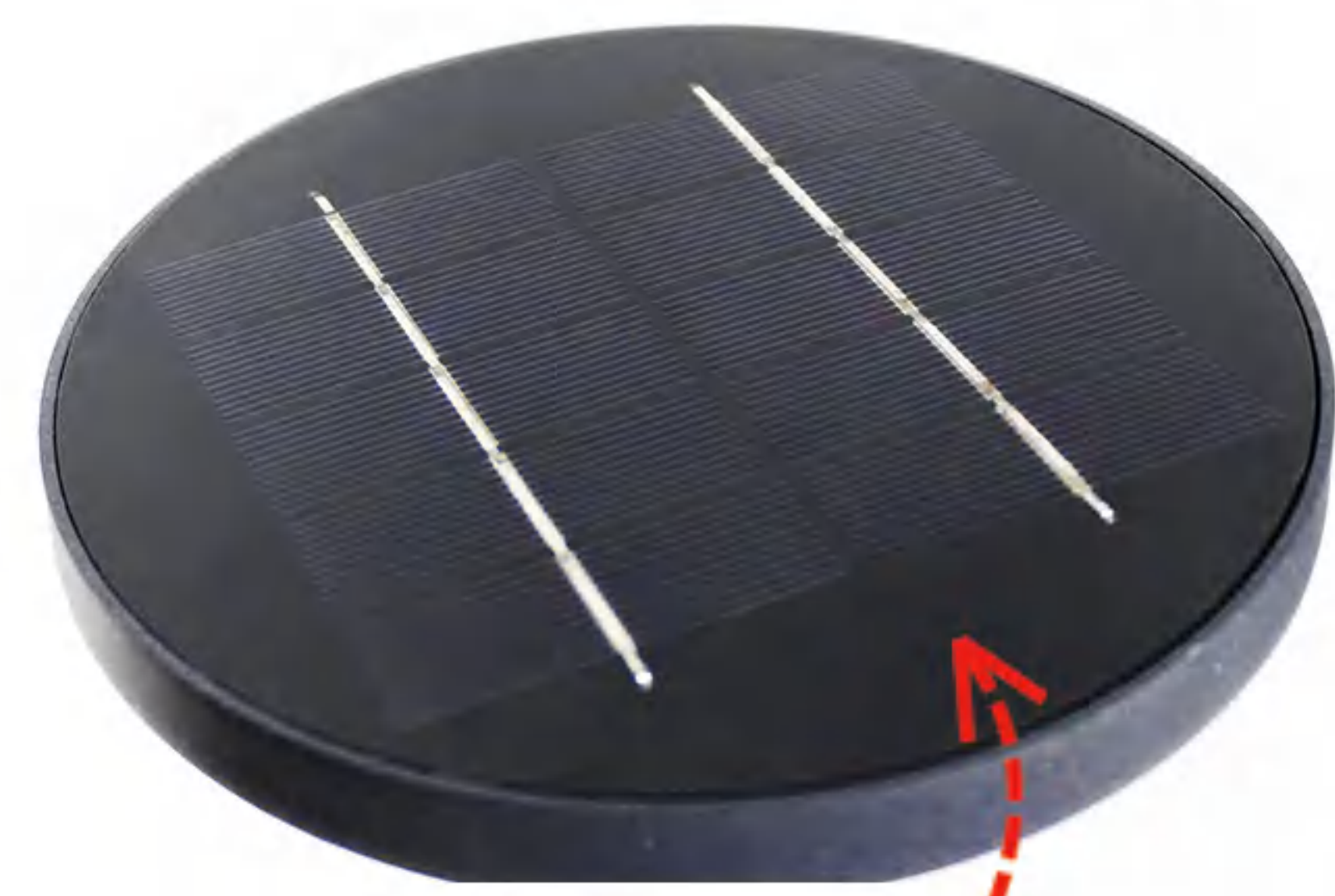
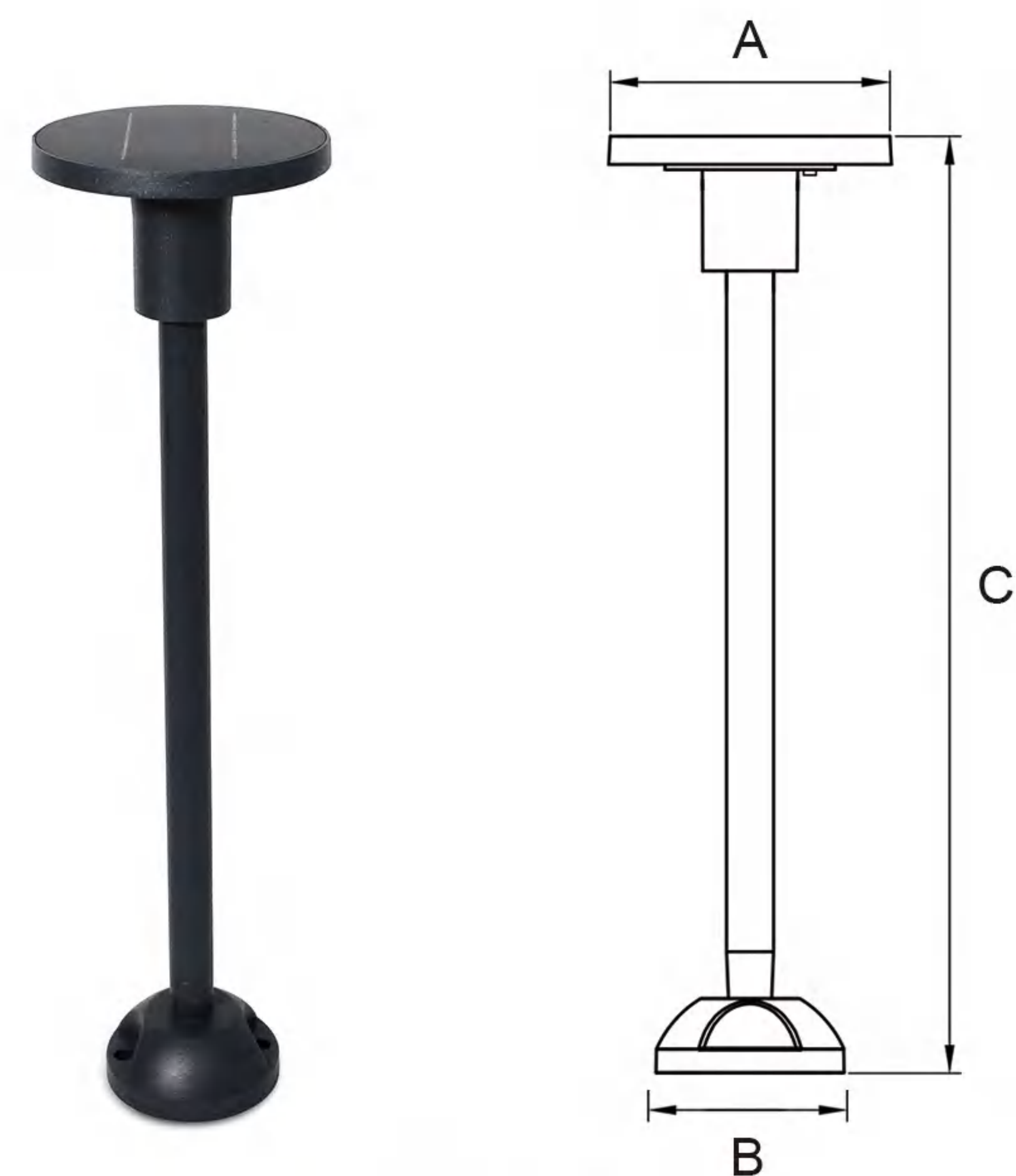

Solar Panel



No/Off

# MB21-BL22-SL

## Features&Benefit (功能和优点)

Category (品类)	Garden Light
Diffuser Material (扩散器材质)	PC
Cover Material (面盖材质)	Aluminum+Solar Panel
Operating mode (运行)	Built in
Steuerbar (开关)	On/Off
Working Hours (工作时长)	8 Hours
IP (防水等级)	54
Mounting type (安装类型)	Put
Mounting location (安装位置)	Overground
Application environment (应用环境)	Indoor/Outdoor
Body color (表面颜色)	Black/Dark Gray/Sliver Gray



# SOLAR LIGHT

## Product Description (产品描述)

Suitable for urban slow lane, narrow lanes, residential neighborhoods, tourist attractions, parks, squares, private gardens, courtyard corridors and other public places of the road on one side or both sides of the road lighting; unique design, soft light, so that the scene is full of layers.

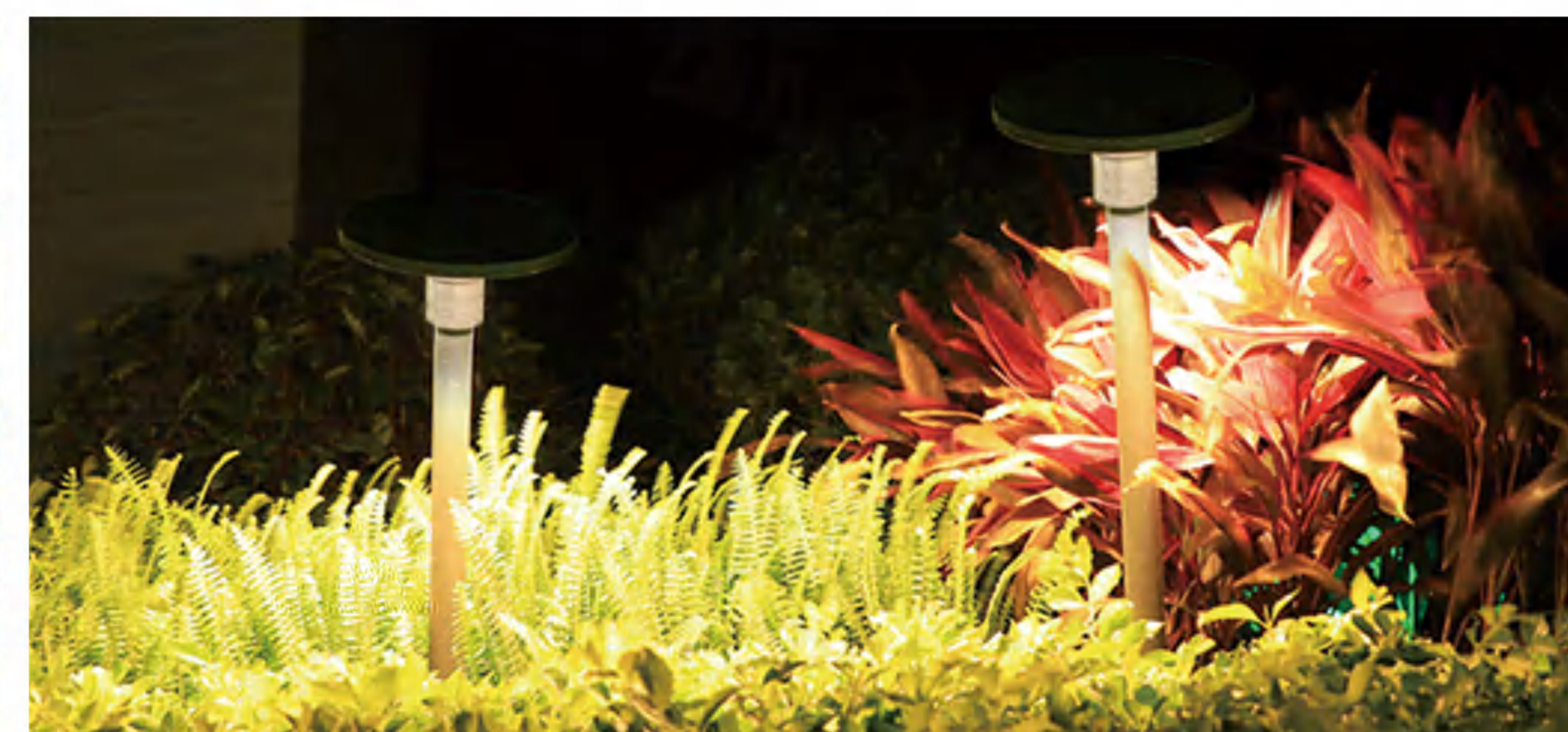

## Technical Date (技术参数)

Item No.	Lamp Type	Power	LM	CCT	CRI	A	B	C (mm)
MB21-BL22-DL	LED	3W	210	2700K-6000K	80-90	Ø150	Ø100	500



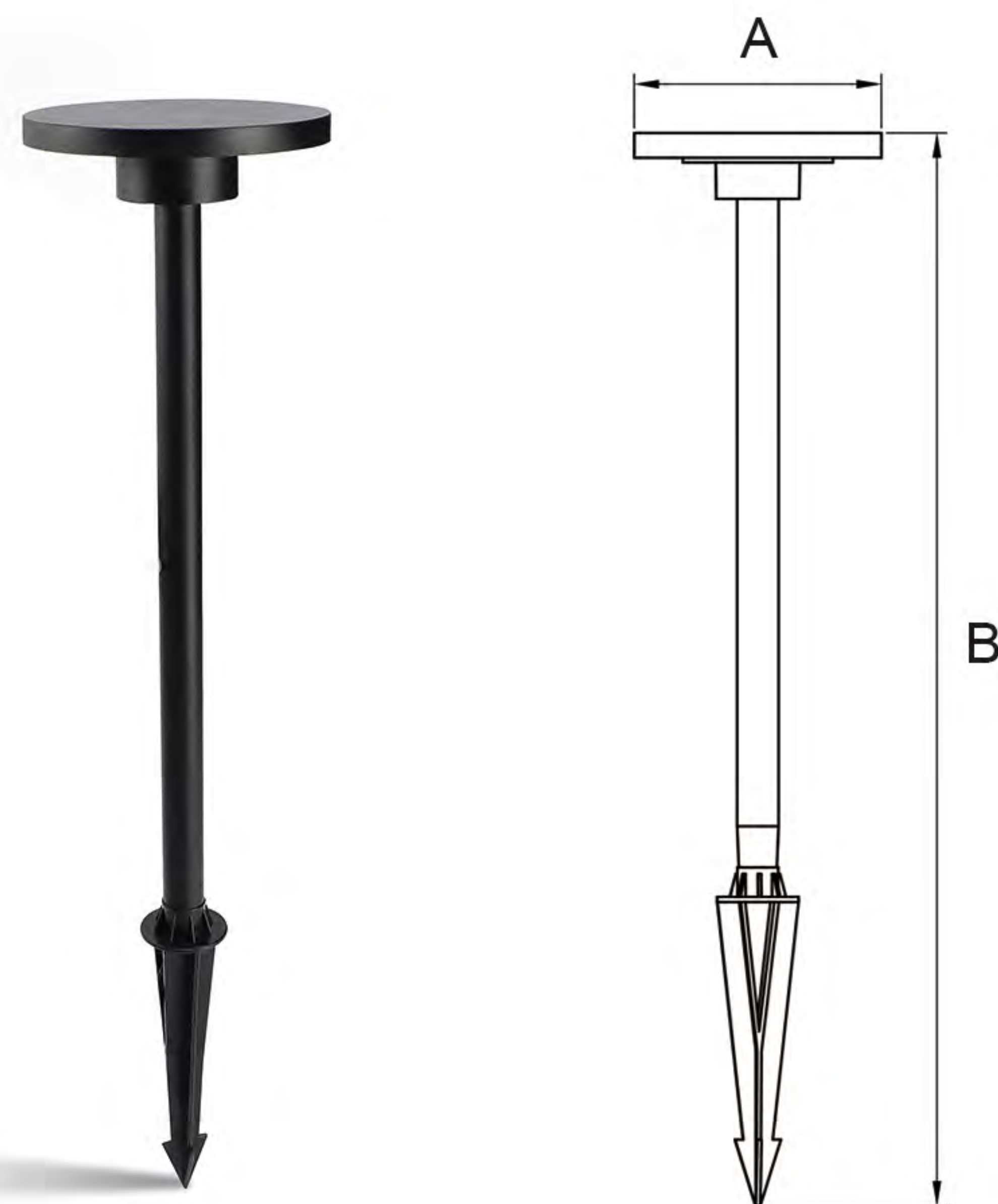

# MB21-BL23

## Features&Benefit (功能和优点)

Category (品类)	Garden Light
Diffuser Material (扩散器材质)	PC
Cover Material (面盖材质)	Aluminum
Operating mode (运行)	Built in
Steuerbar (开关)	On/Off
IP (防水等级)	54
Mounting type (安装类型)	Insert
Mounting location (安装位置)	Underground
Application environment (应用环境)	Indoor/Outdoor
Body color (表面颜色)	Black/Dark Gray/Sliver Gray



## Product Description (产品描述)

Suitable for urban slow lane, narrow lanes, residential neighborhoods, tourist attractions, parks, squares, private gardens, courtyard corridors and other public places of the road on one side or both sides of the road lighting; unique design, soft light, so that the scene is full of layers.

## Lightmap (光影图)



top view (俯视图)

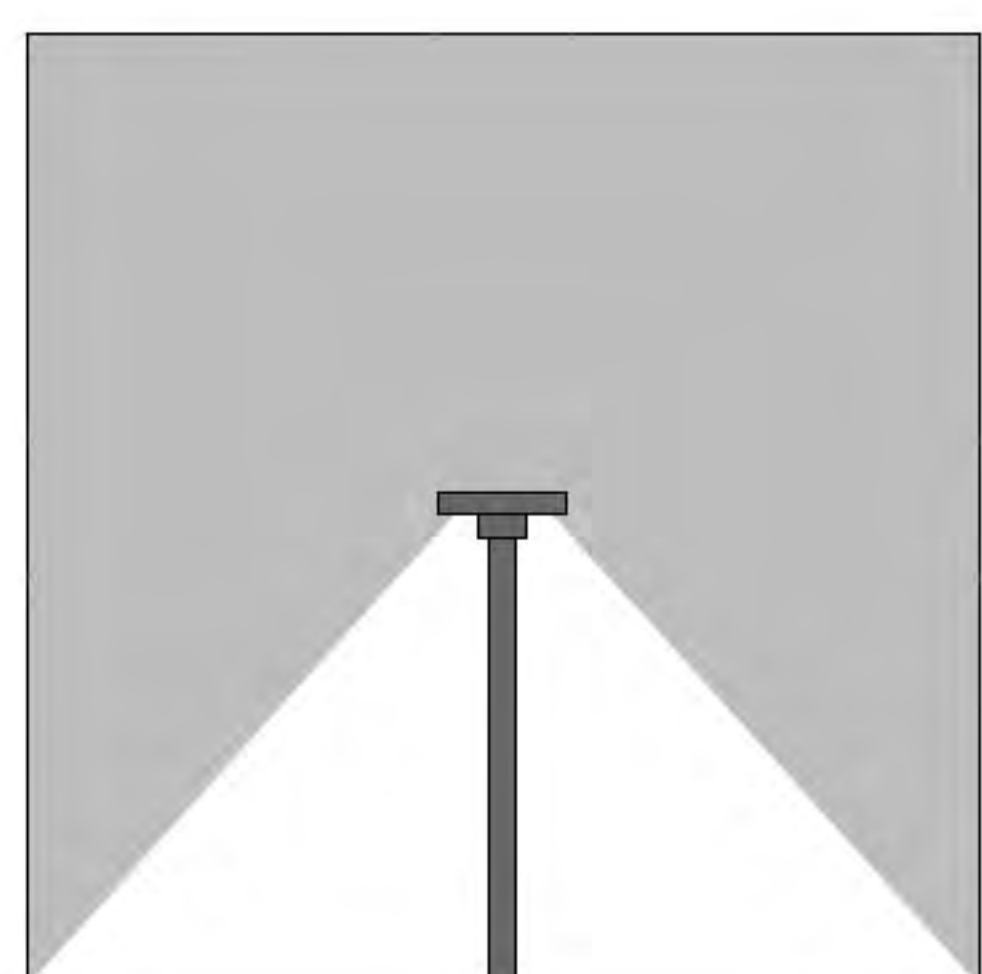

front view (正面图)

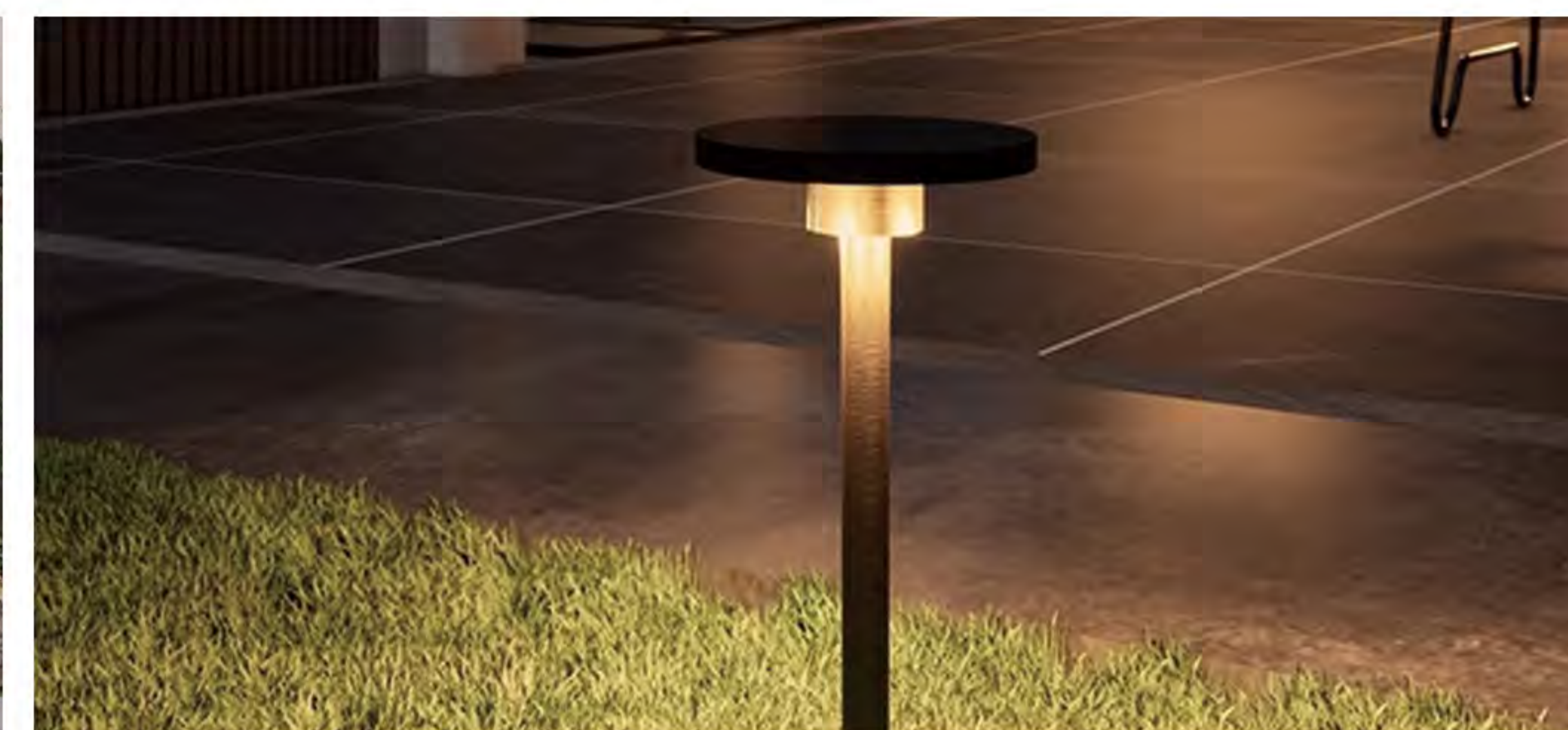

## Technical Date (技术参数)

Item No.	Lamp Type	Power	LM	CCT	PF	Voltage	CRI	A	B	C (mm)
MB21-BL23	LED	10W	700	2700K-6000K	0.6	AC110-265V	80-90	Ø150	665	-



# MB21-BL23-SL

# SOLAR LIGHT

## Features&Benefit (功能和优点)

Category (品类)	Garden Light
Diffuser Material (扩散器材质)	PC
Cover Material (面盖材质)	Aluminum+Solar Panel
Operating mode (运行)	Built in
Steuerbar (开关)	On/Off
Working Hours (工作时长)	8 Hours
IP (防水等级)	54
Mounting type (安装类型)	Insert
Mounting location (安装位置)	Underground
Application environment (应用环境)	Indoor/Outdoor
Body color (表面颜色)	Black/Dark Gray/Sliver Gray



## Product Description (产品描述)

Suitable for urban slow lane, narrow lanes, residential neighborhoods, tourist attractions, parks, squares, private gardens, courtyard corridors and other public places of the road on one side or both sides of the road lighting; unique design, soft light, so that the scene is full of layers.

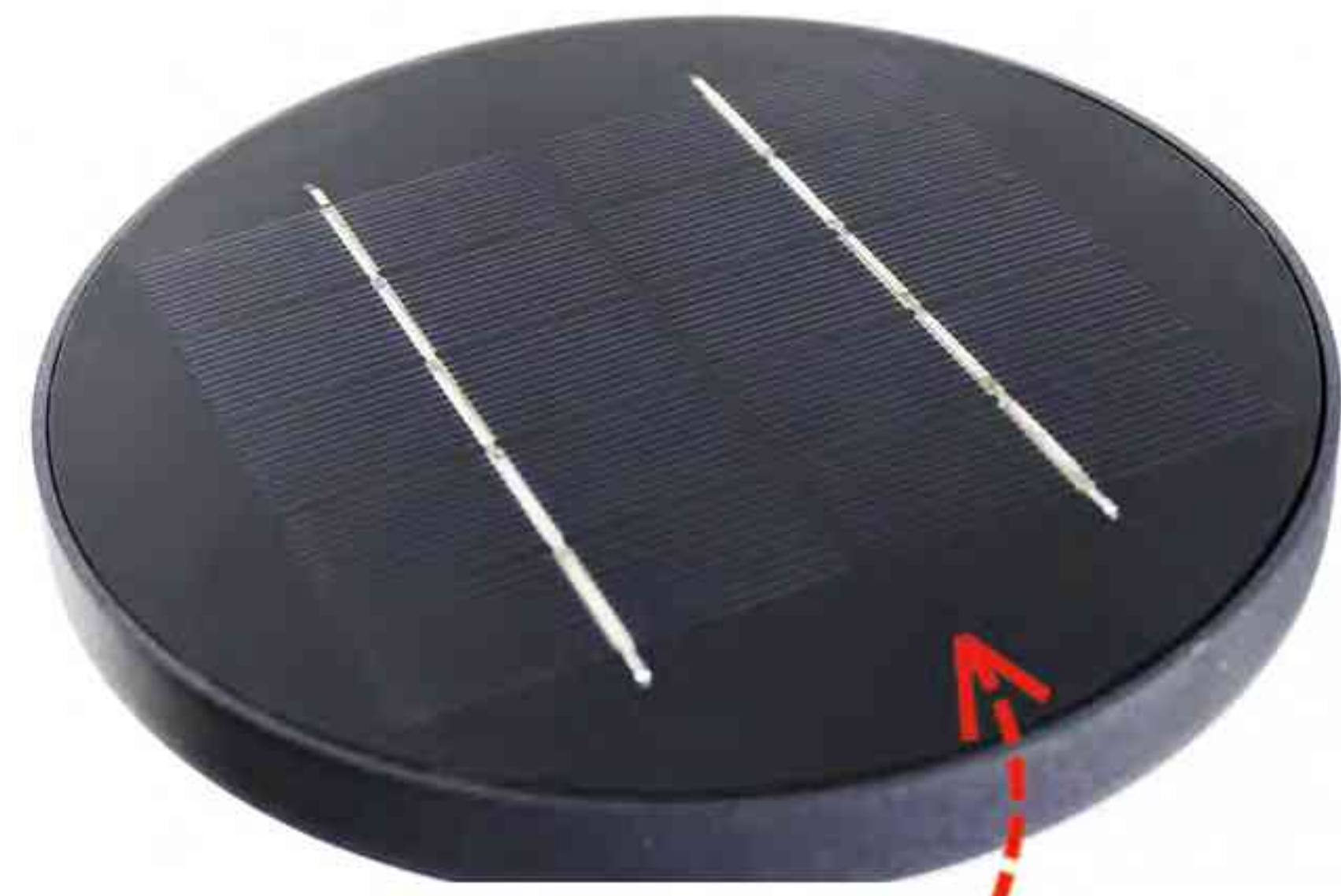
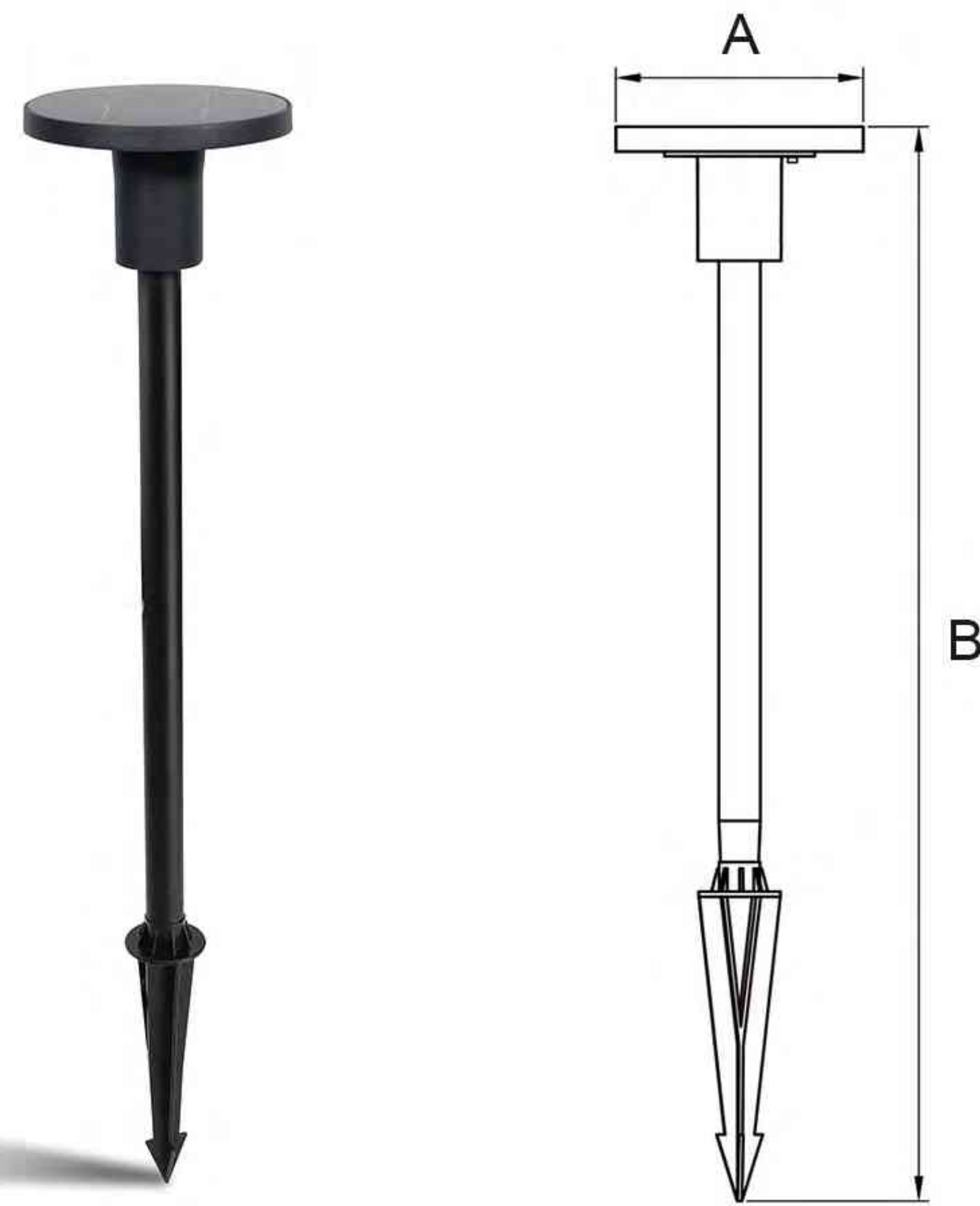

Solar Panel



No/Off



## Technical Date (技术参数)

Item No.	Lamp Type	Power	LM	CCT	CRI	A	B	C (mm)
MB21-BL23-SL	LED	3W	210	2700K-6000K	80-90	Ø150	665	-



# MB21-BL24

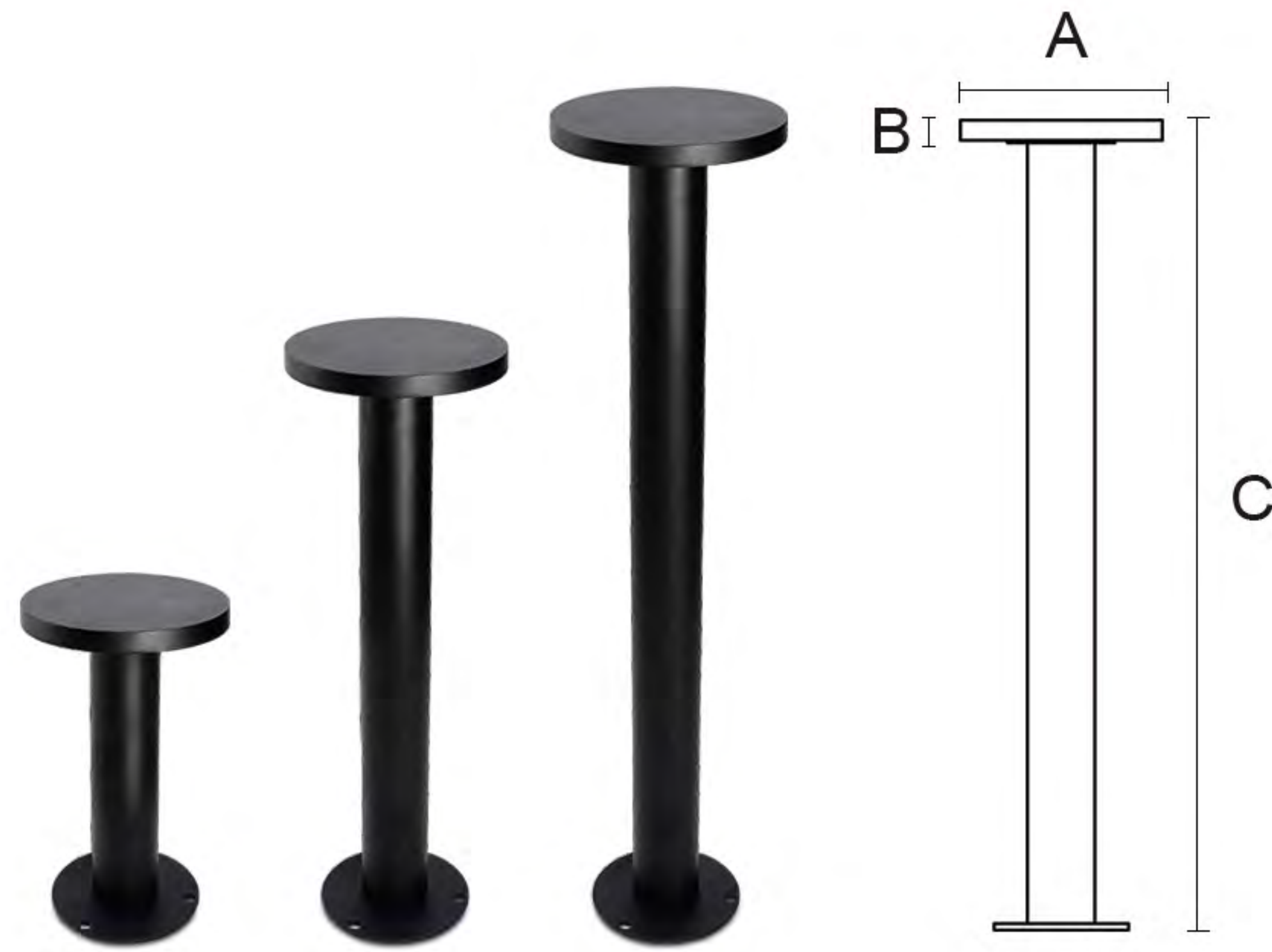

## Features&Benefit (功能和优点)

Category (品类)	Garden Light
Diffuser Material (扩散器材质)	PC
Cover Material (面盖材质)	Aluminum
Operating mode (运行)	Built in
Steuerbar (开关)	On/Off
IP (防水等级)	54
Mounting type (安装类型)	Put
Mounting location (安装位置)	Overground
Application environment (应用环境)	Indoor/Outdoor
Body color (表面颜色)	Black/Dark Gray/Sliver Gray



## Product Description (产品描述)

Suitable for urban slow lane, narrow lanes, residential neighborhoods, tourist attractions, parks, squares, private gardens, courtyard corridors and other public places of the road on one side or both sides of the road lighting; unique design, soft light, so that the scene is full of layers.

## Lightmap (光影图)



top view (俯视图)

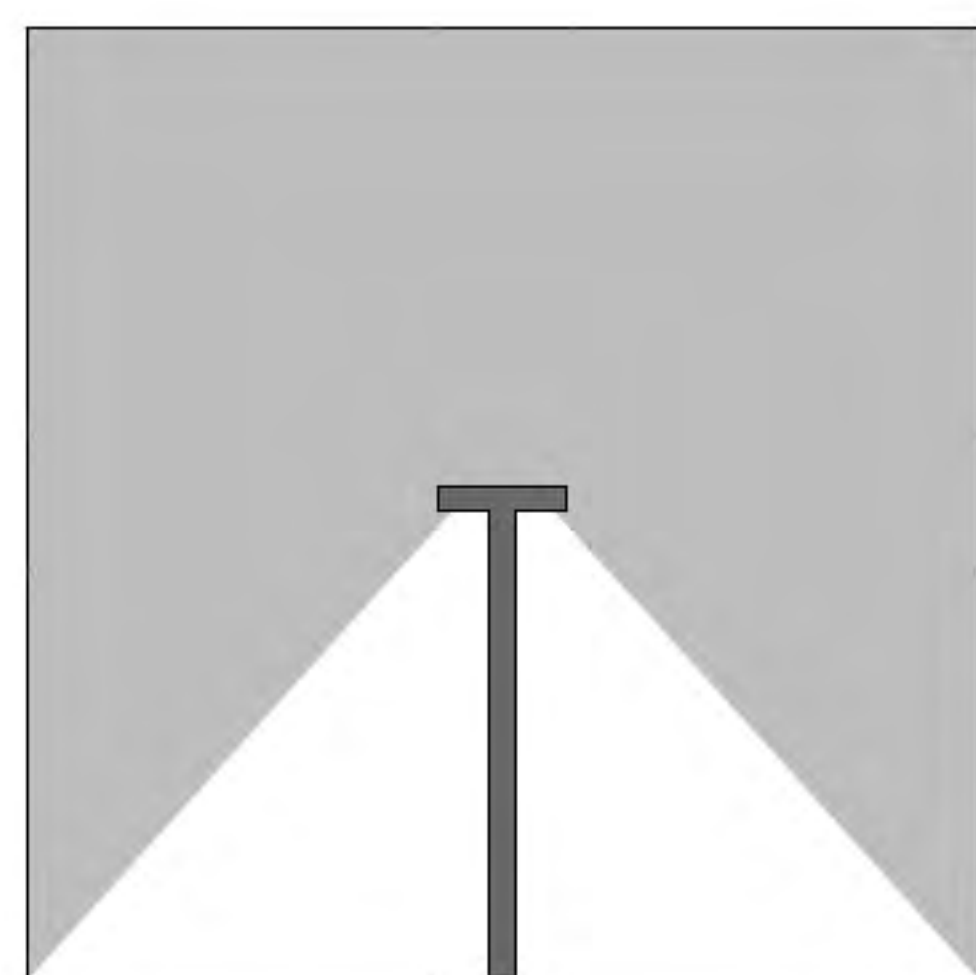

front view (正面图)



## Technical Date (技术参数)

Item No.	Lamp Type	Power	LM	CCT	PF	Voltage	CRI	A	B	C (mm)
MB21-BL24A	LED	10W	700	2700K-6000K	0.6	AC110-265V	80-90	Ø150	15	400
MB21-BL24B	LED	10W	700	2700K-6000K	0.6	AC110-265V	80-90	Ø150	15	600
MB21-BL24C	LED	10W	700	2700K-6000K	0.6	AC110-265V	80-90	Ø150	15	900



# MB23-0201

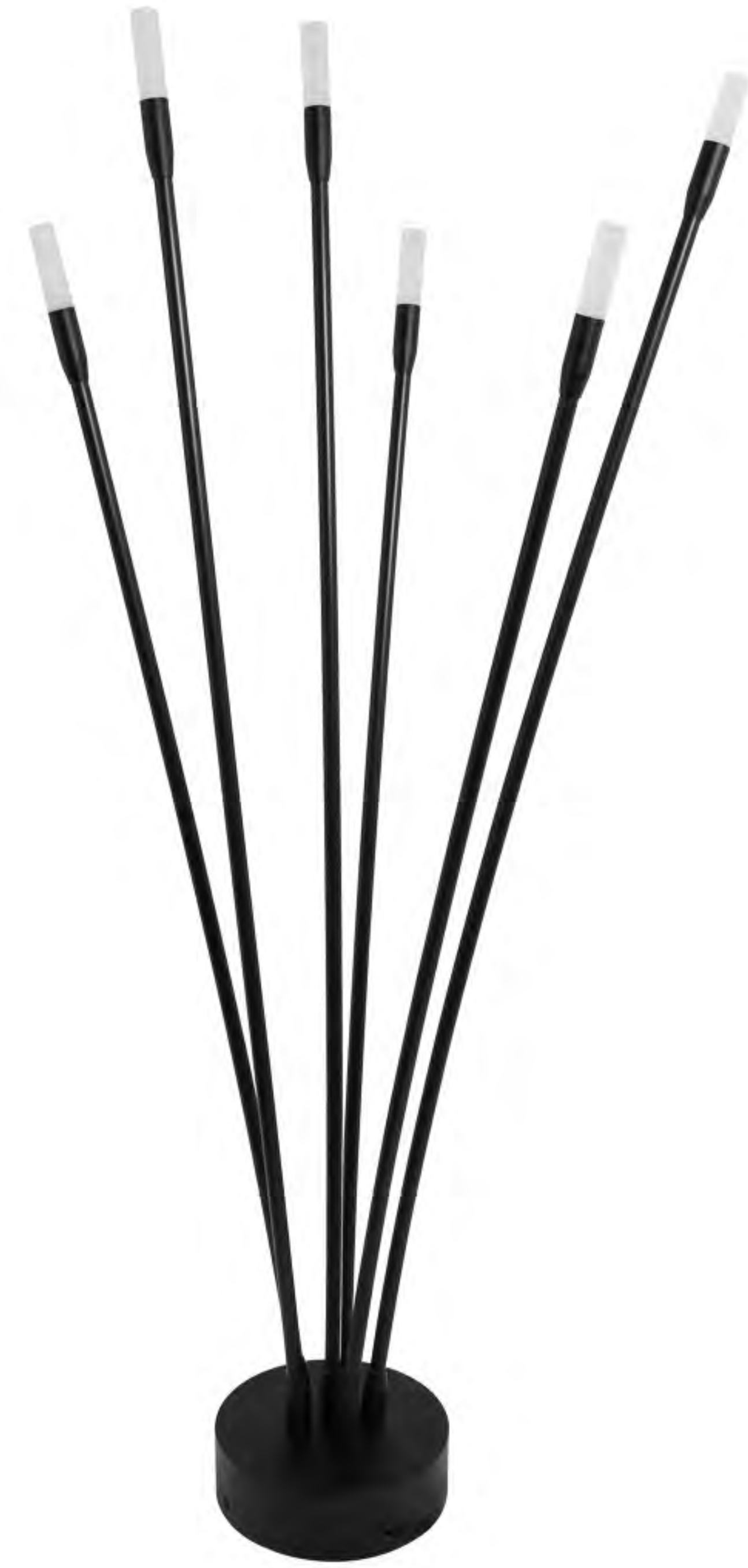

## Features&Benefit (功能和优点)

Category (品类)	Garden Light
Diffuser Material (扩散器材质)	Acrylic
Cover Material (面盖材质)	PVC
Operating mode (运行)	Built in
Steuerbar (开关)	On/Off
IP (防水等级)	54
Mounting type (安装类型)	Put
Mounting location (安装位置)	Overground
Application environment (应用环境)	Indoor/Outdoor
Body color (表面颜色)	Black



## Product Description (产品描述)

Suitable for urban slow lane, narrow lanes, residential neighborhoods, tourist attractions, parks, squares, private gardens, courtyard corridors and other public places of the road on one side or both sides of the road lighting; unique design, soft light, so that the scene is full of layers.

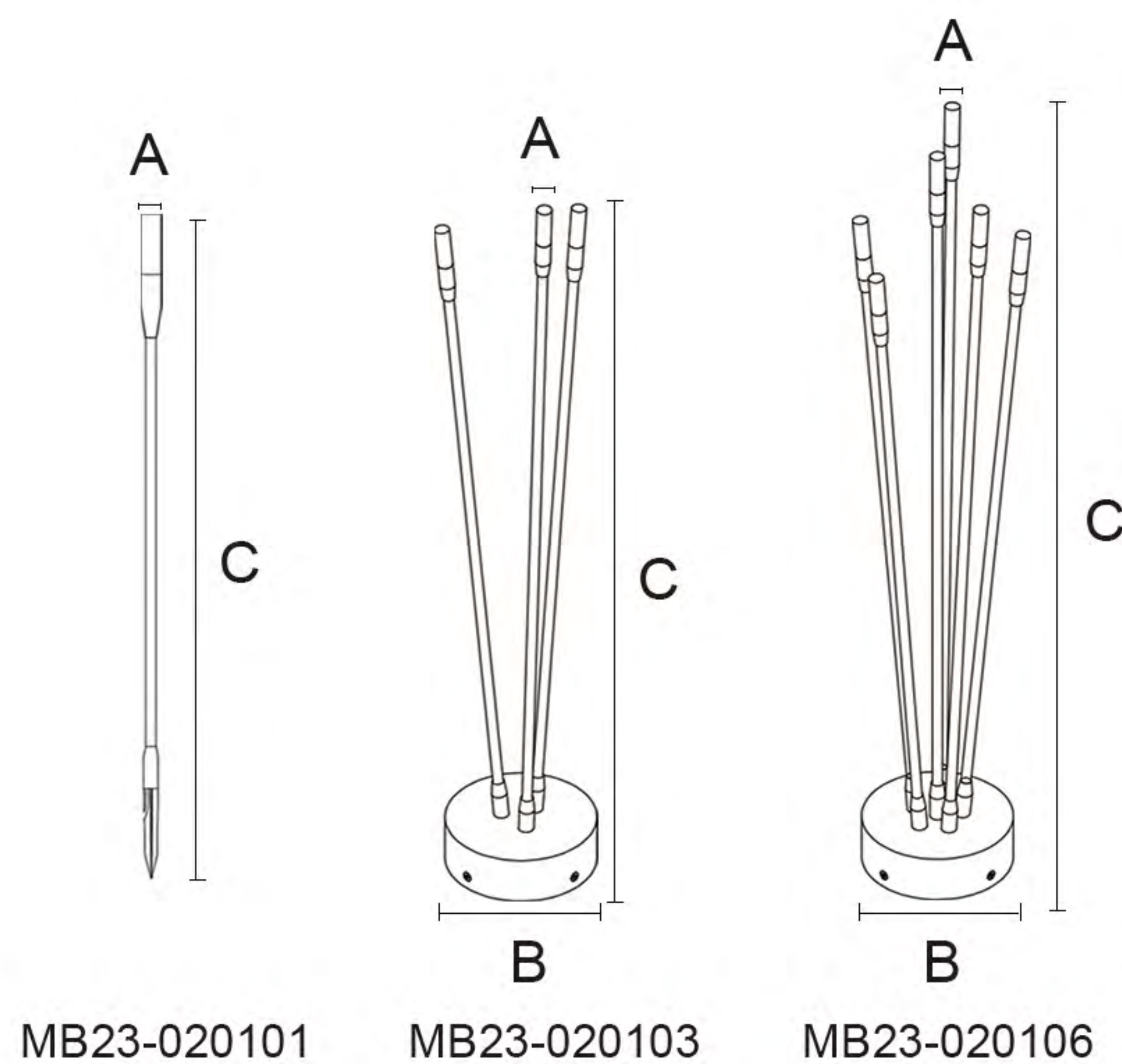

## Technical Date (技术参数)

Item No.	Lamp Type	Power	LM	CCT	PF	Voltage	CRI	A	B	C (mm)
MB23-020101	LED	1W	70	2700K-6000K	0.6	AC12V	80-90	Ø18	-	700
MB23-020103	LED	3*1W	210	2700K-6000K	0.6	AC12V	80-90	Ø18	Ø150	700
MB23-020106	LED	6*1W	420	2700K-6000K	0.6	AC12V	80-90	Ø18	Ø150	800



# MB23-0202



## Features&Benefit (功能和优点)

Category (品类)	Garden Light
Diffuser Material (扩散器材质)	Glass
Cover Material (面盖材质)	Aluminum
Operating made (运行)	Built in
Steuerbar (开关)	On/Off
IP (防水等级)	54
Mounting type (安装类型)	Put
Mounting location (安装位置)	Overground
Application environment (应用环境)	Indoor/Outdoor
Body color (表面颜色)	Black/Dark Gray/Sliver Gray



## Product Description (产品描述)

Suitable for urban slow lane, narrow lanes, residential neighborhoods, tourist attractions, parks, squares, private gardens, courtyard corridors and other public places of the road on one side or both sides of the road lighting; unique design, soft light, so that the scene is full of layers.

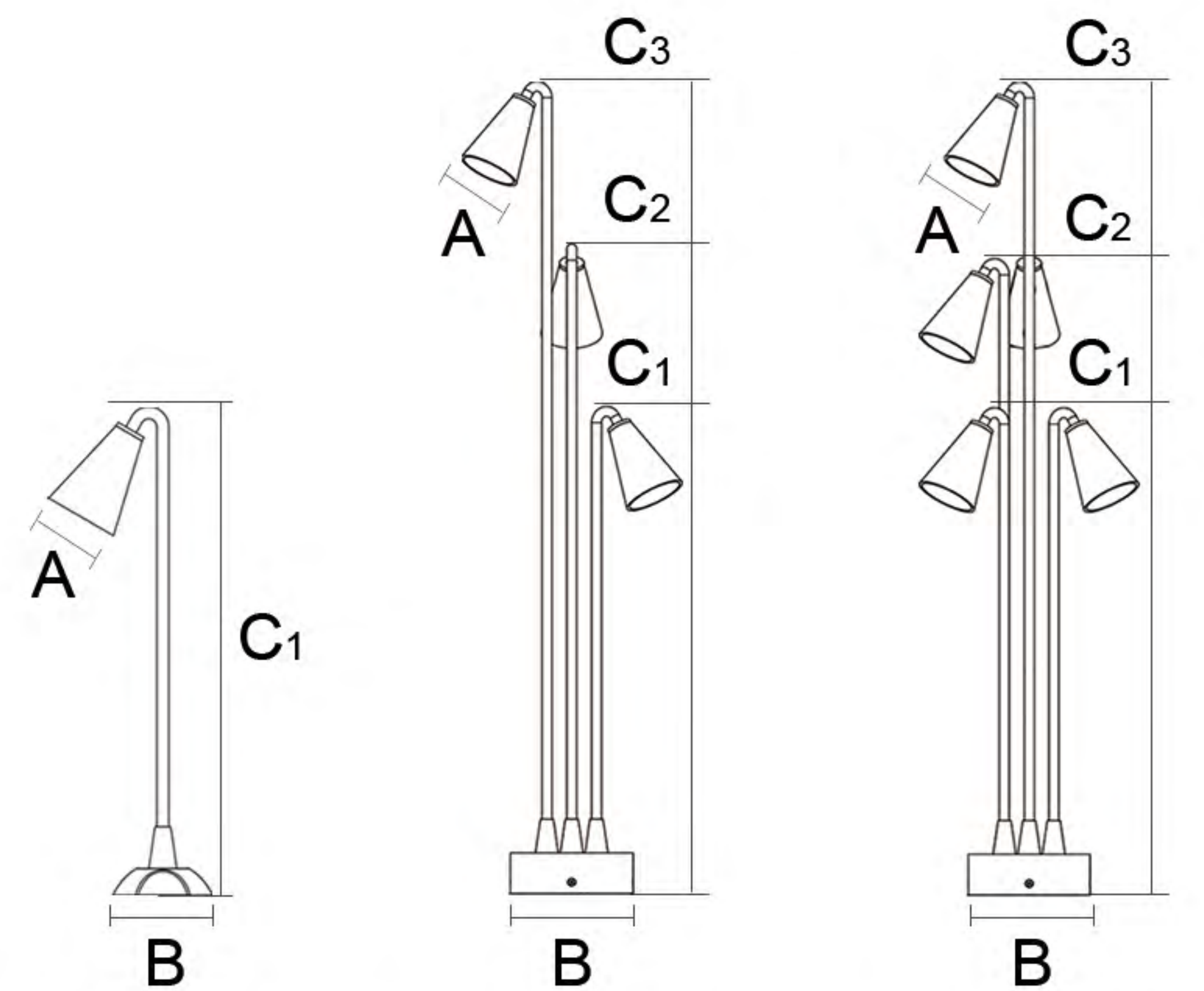

MB23-020201

MB23-020203

MB23-020205

## Technical Date (技术参数)

Item No.	Lamp Type	Power	LM	CCT	PF	Voltage	CRI	A	B	C <sub>1</sub>	C <sub>2</sub>	C <sub>3</sub> (mm)
MB23-020201	LED	1*3W	210	2700K-6000K	0.6	AC110-265V	80-90	Ø75	Ø150	600	-	-
MB23-020203	LED	3*3W	630	2700K-6000K	0.6	AC110-265V	80-90	Ø75	Ø150	600	800	1000
MB23-020205	LED	5*3W	1050	2700K-6000K	0.6	AC110-265V	80-90	Ø75	Ø150	600	800	1000





# MB23-0203

## Features&Benefit (功能和优点)

Category (品类)	Garden Light
Diffuser Material (扩散器材质)	PC
Cover Material (面盖材质)	Aluminum
Operating made (运行)	Built in
Steuerbar (开关)	On/Off
IP (防水等级)	54
Mounting type (安装类型)	Put
Mounting location (安装位置)	Overground
Application environment (应用环境)	Indoor/Outdoor
Body color (表面颜色)	Black/Dark Gray/Sliver Gray



## Product Description (产品描述)

Suitable for urban slow lane, narrow lanes, residential neighborhoods, tourist attractions, parks, squares, private gardens, courtyard corridors and other public places of the road on one side or both sides of the road lighting; unique design, soft light, so that the scene is full of layers.

## Lightmap (光影图)



top view (俯视图)

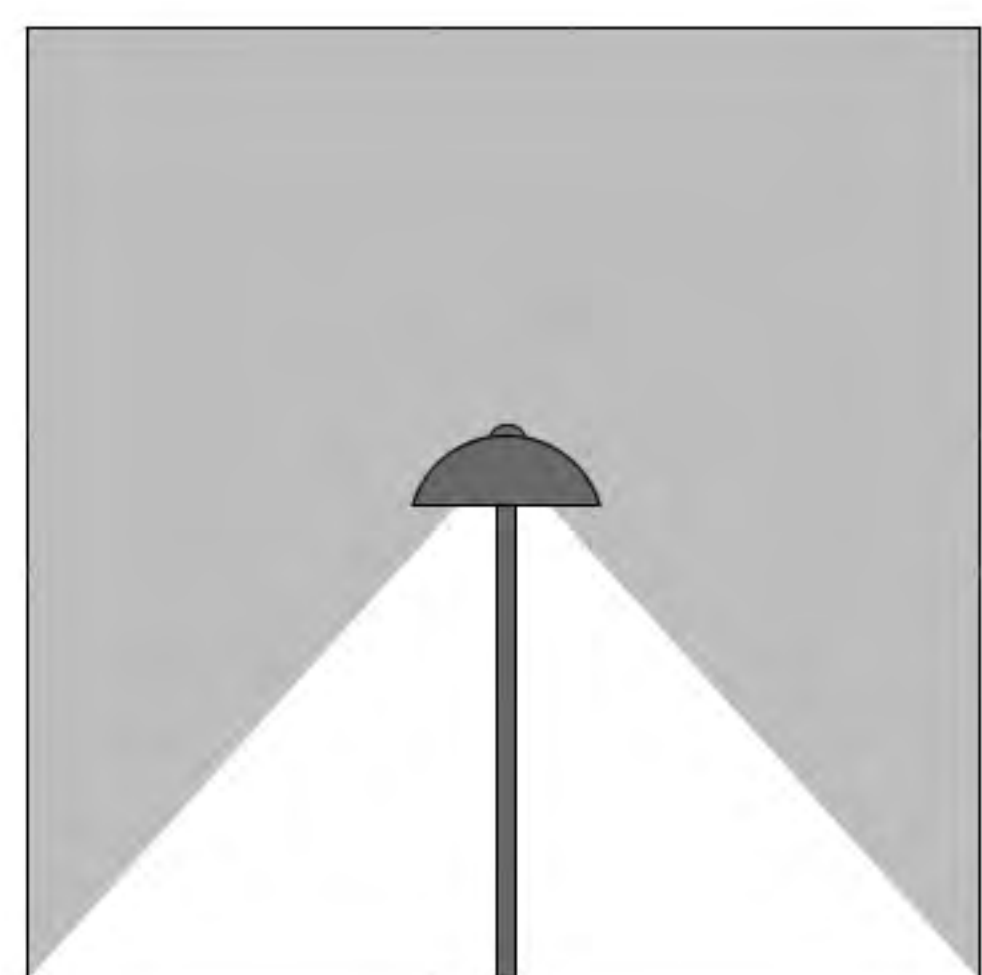

front view (正面图)



## Technical Date (技术参数)

Item No.	Lamp Type	Power	LM	CCT	PF	Voltage	CRI	A	B	C (mm)
MB23-0203	LED	7W	490	2700K-6000K	0.6	AC110-265V	80-90	Ø200	Ø100	550



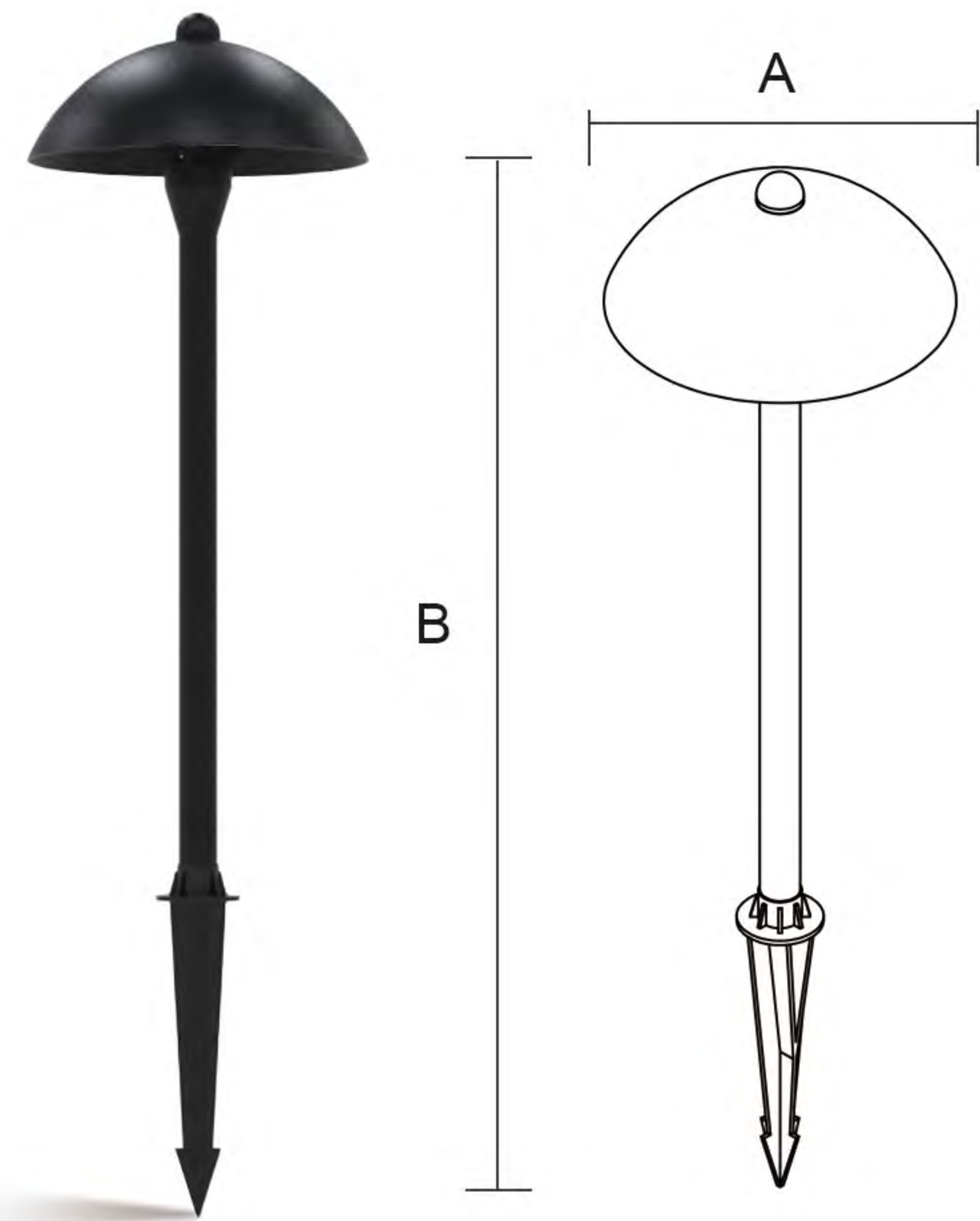

# MB23-0204

## Features&Benefit (功能和优点)

Category (品类)	Garden Light
Diffuser Material (扩散器材质)	PC
Cover Material (面盖材质)	Aluminum
Operating mode (运行)	Built in
Steuerbar (开关)	On/Off
IP (防水等级)	54
Mounting type (安装类型)	Insert
Mounting location (安装位置)	Underground
Application environment (应用环境)	Indoor/Outdoor
Body color (表面颜色)	Black/Dark Gray/Sliver Gray



## Product Description (产品描述)

Suitable for urban slow lane, narrow lanes, residential neighborhoods, tourist attractions, parks, squares, private gardens, courtyard corridors and other public places of the road on one side or both sides of the road lighting; unique design, soft light, so that the scene is full of layers.

## Lightmap (光影图)



top view (俯视图)

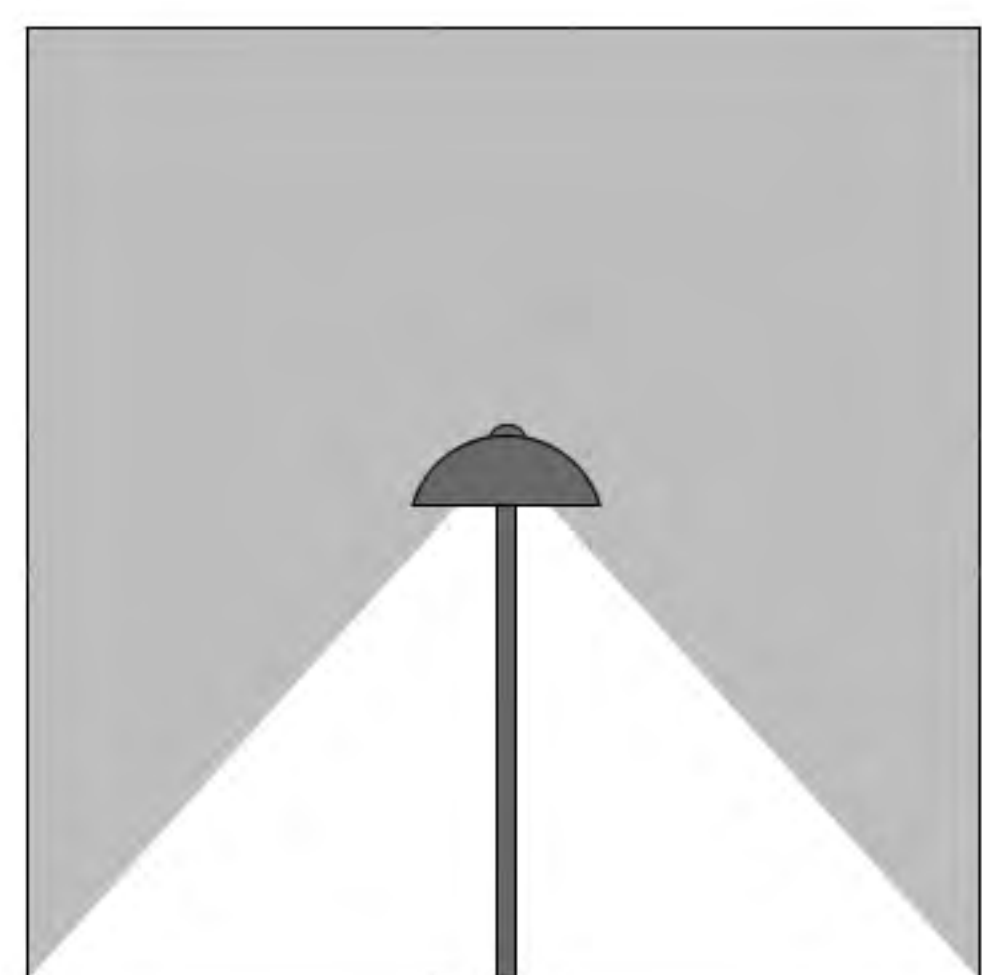

front view (正面图)



## Technical Date (技术参数)

Item No.	Lamp Type	Power	LM	CCT	PF	Voltage	CRI	A	B	C (mm)
MB23-0204	LED	7W	490	2700K-6000K	0.6	AC110-265V	80-90	Ø200	700	-



# MB23-0205

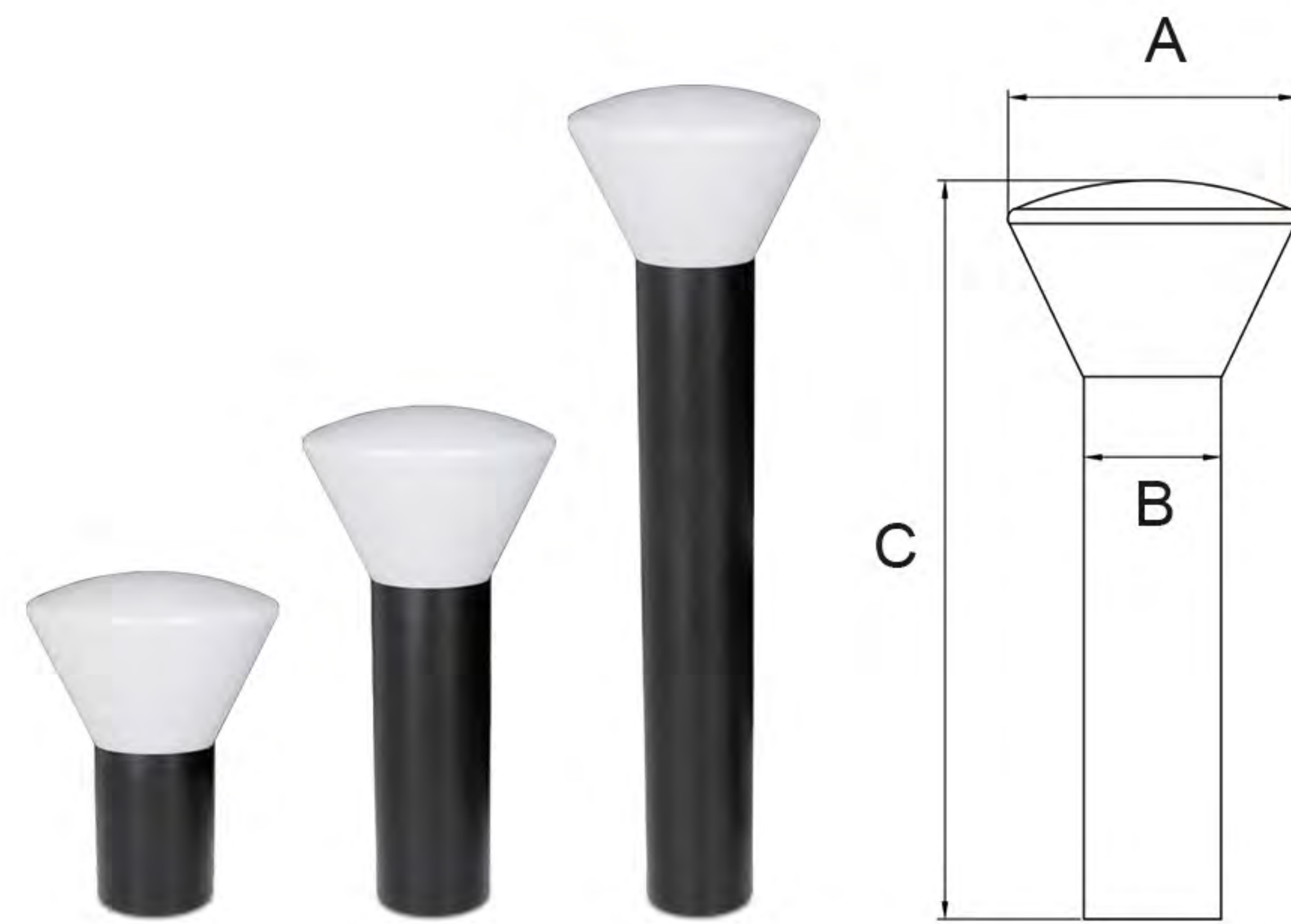

## Features&Benefit (功能和优点)

Category (品类)	Garden Light
Diffuser Material (扩散器材质)	PC
Cover Material (面盖材质)	Aluminum
Operating mode (运行)	Built in
Steuerbar (开关)	On/Off
IP (防水等级)	54
Mounting type (安装类型)	Put
Mounting location (安装位置)	Overground
Application environment (应用环境)	Indoor/Outdoor
Body color (表面颜色)	Black/Dark Gray/Sliver Gray



## Product Description (产品描述)

Suitable for parks and gardens, neighborhoods, villas, city squares, pedestrian streets, scenic spots or resorts and other various scenes; lawn lamps can be a variety of heights at the same time the lighting effect will be different, more to provide a choice.

## Lightmap (光影图)



top view (俯视图)

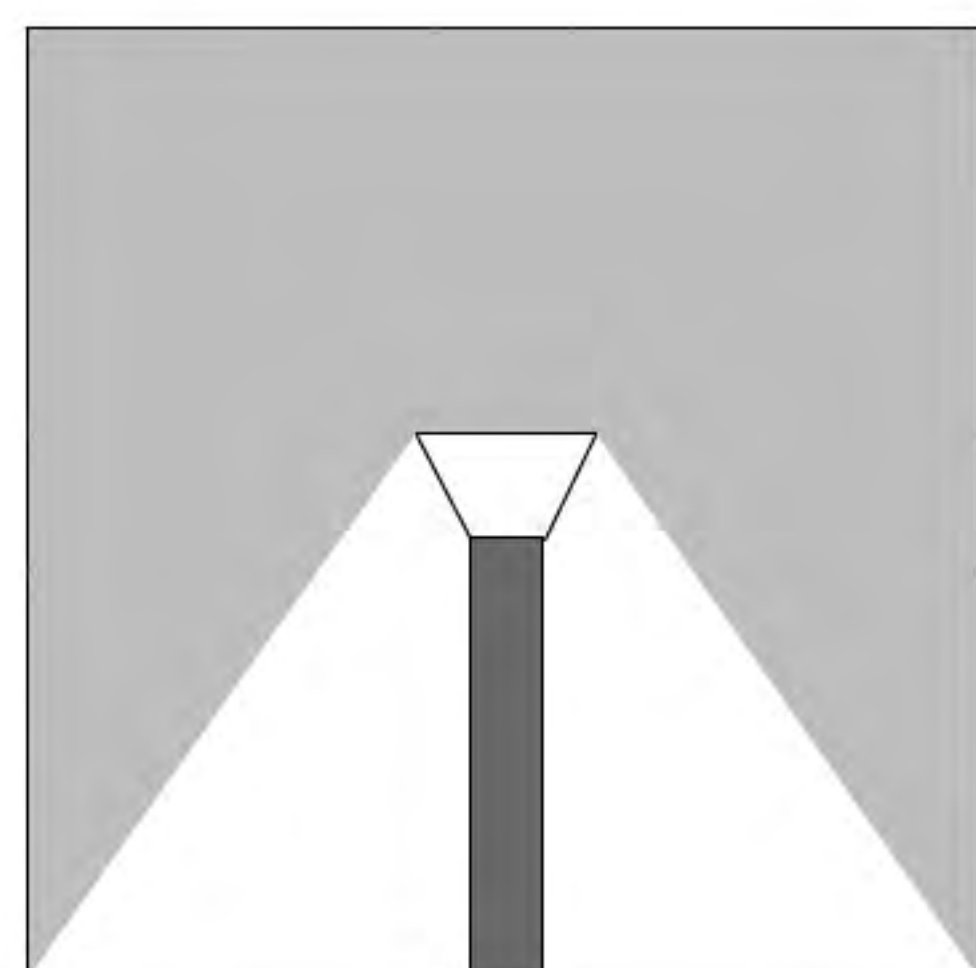

front view (正面图)

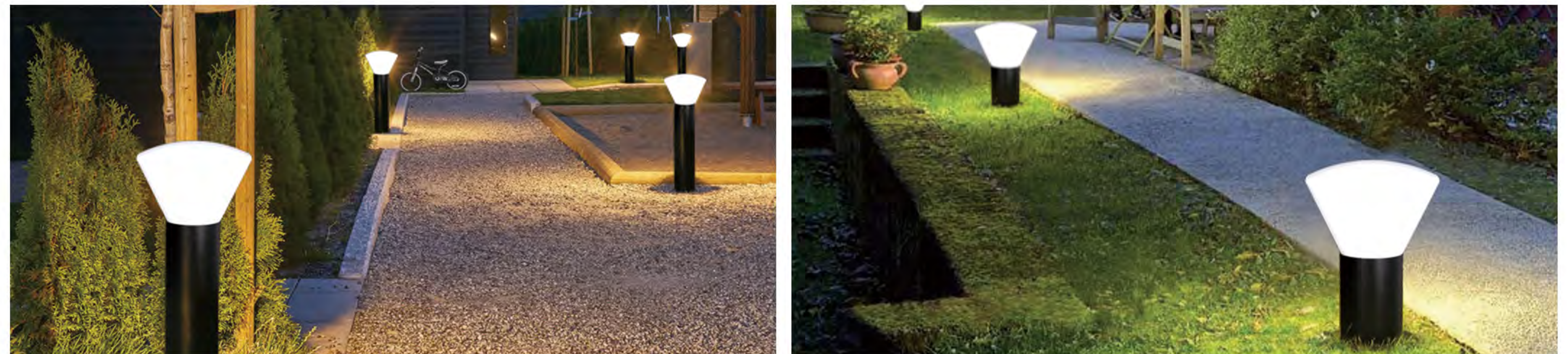

## Technical Date (技术参数)

Item No.	Lamp Type	Power	LM	CCT	PF	Voltage	CRI	A	B	C (mm)
MB23-020504	LED	5W	350	2700K-6000K	0.6	AC110-265V	80-90	Ø160	Ø76	400
MB23-020506	LED	5W	350	2700K-6000K	0.6	AC110-265V	80-90	Ø160	Ø76	600
MB23-0205010	LED	5W	350	2700K-6000K	0.6	AC110-265V	80-90	Ø160	Ø76	1000



# MB23-0206

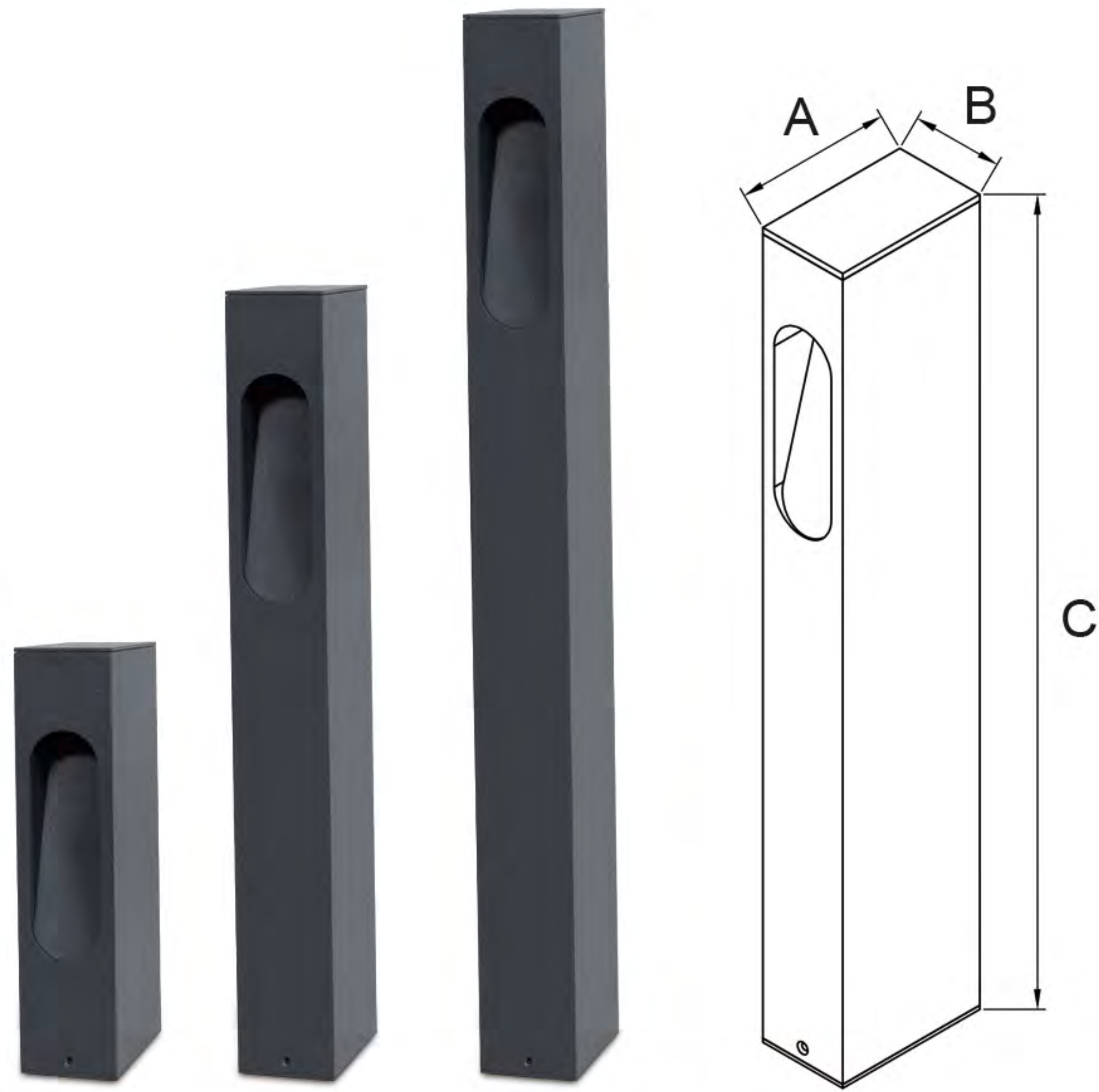

## Features&Benefit (功能和优点)

Category (品类)	Garden Light
Diffuser Material (扩散器材质)	Glass
Cover Material (面盖材质)	Aluminum
Operating mode (运行)	Built in
Steuerbar (开关)	On/Off
IP (防水等级)	54
Mounting type (安装类型)	Put
Mounting location (安装位置)	Overground
Application environment (应用环境)	Indoor/Outdoor
Body color (表面颜色)	Black/Dark Gray/Sliver Gray



## Product Description (产品描述)

Suitable for parks and gardens, neighborhoods, villas, city squares, pedestrian streets, scenic spots or resorts and other various scenes; lawn lamps can be a variety of heights at the same time the lighting effect will be different, more to provide a choice.

## Lightmap (光影图)

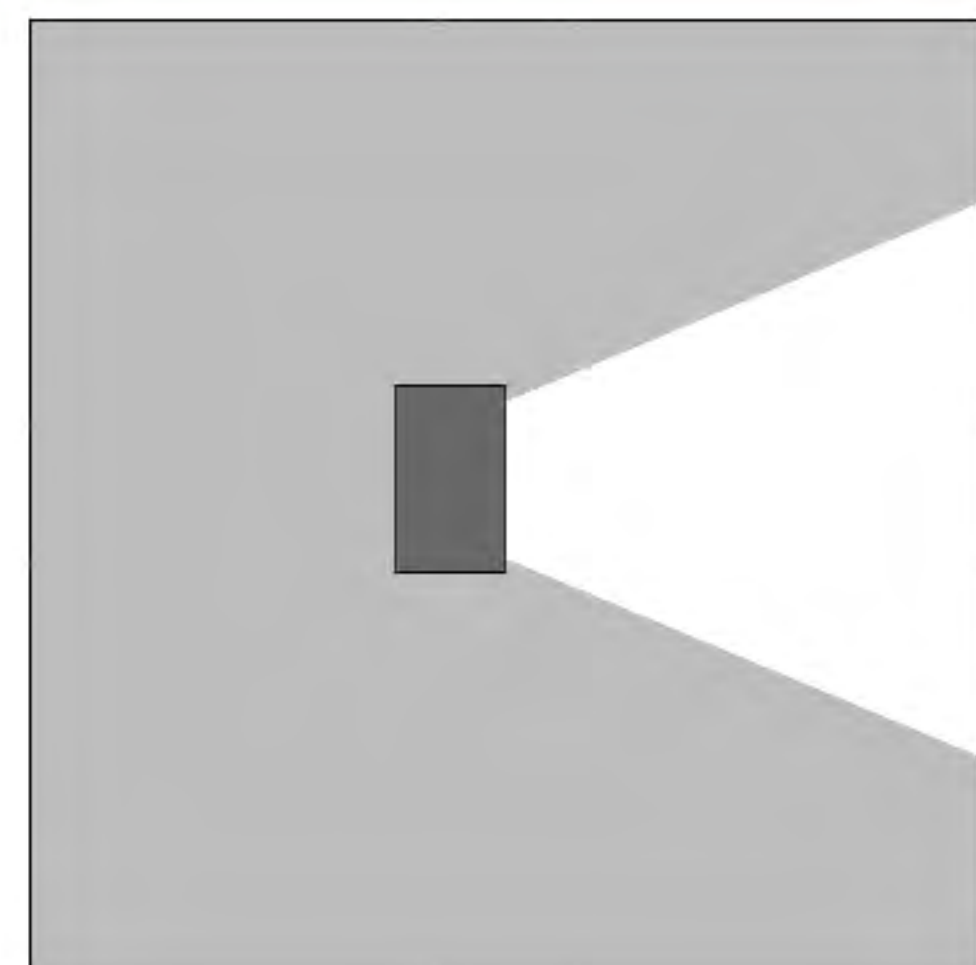

top view (俯视图)

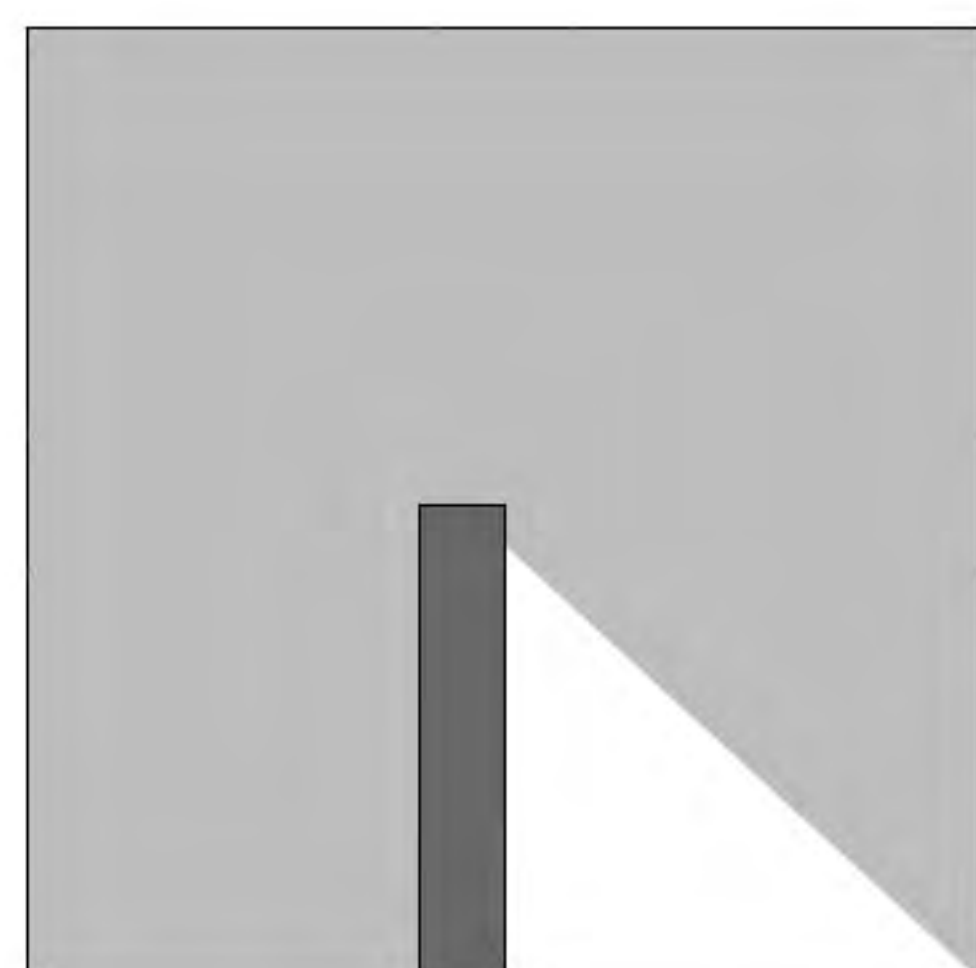

front view (正面图)



## Technical Date (技术参数)

Item No.	Lamp Type	Power	LM	CCT	PF	Voltage	CRI	A	B	C (mm)
MB23-020603	LED	7W	490	2700K-6000K	0.6	AC110-265V	80	120	70	300
MB23-020606	LED	7W	490	2700K-6000K	0.6	AC110-265V	80	120	70	600
MB23-020609	LED	7W	490	2700K-6000K	0.6	AC110-265V	80	120	70	900



# MB23-0208

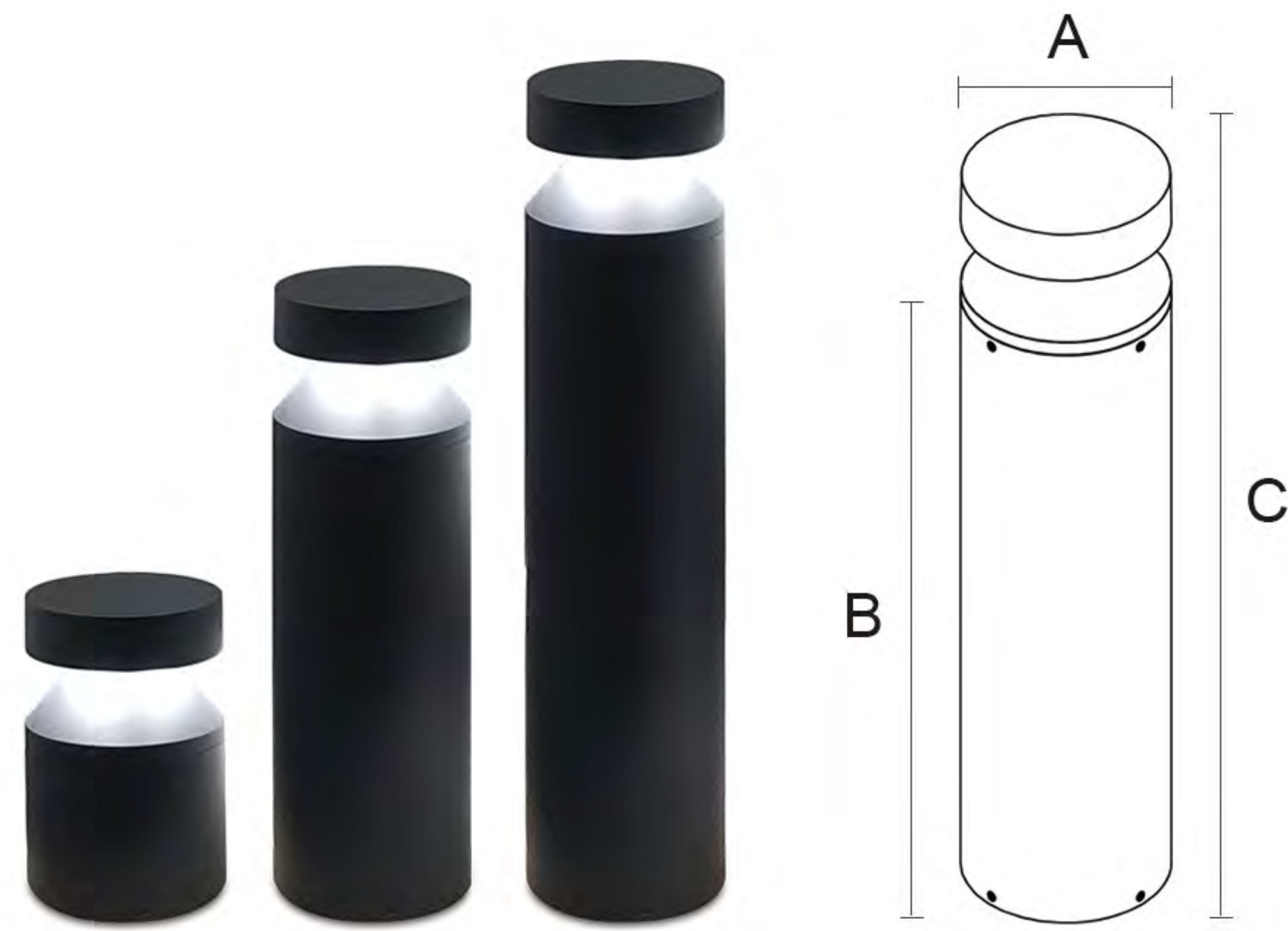

## Features&Benefit (功能和优点)

Category (品类)	Garden Light
Diffuser Material (扩散器材质)	PC
Cover Material (面盖材质)	Aluminum
Operating mode (运行)	Built in
Steuerbar (开关)	On/Off
IP (防水等级)	54
Mounting type (安装类型)	Put
Mounting location (安装位置)	Overground
Application environment (应用环境)	Indoor/Outdoor
Body color (表面颜色)	Black/Dark Gray/Sliver Gray



## Product Description (产品描述)

Suitable for parks and gardens, neighborhoods, villas, city squares, pedestrian streets, scenic spots or resorts and other various scenes; lawn lamps can be a variety of heights at the same time the lighting effect will be different, more to provide a choice.

## Lightmap (光影图)



top view (俯视图)

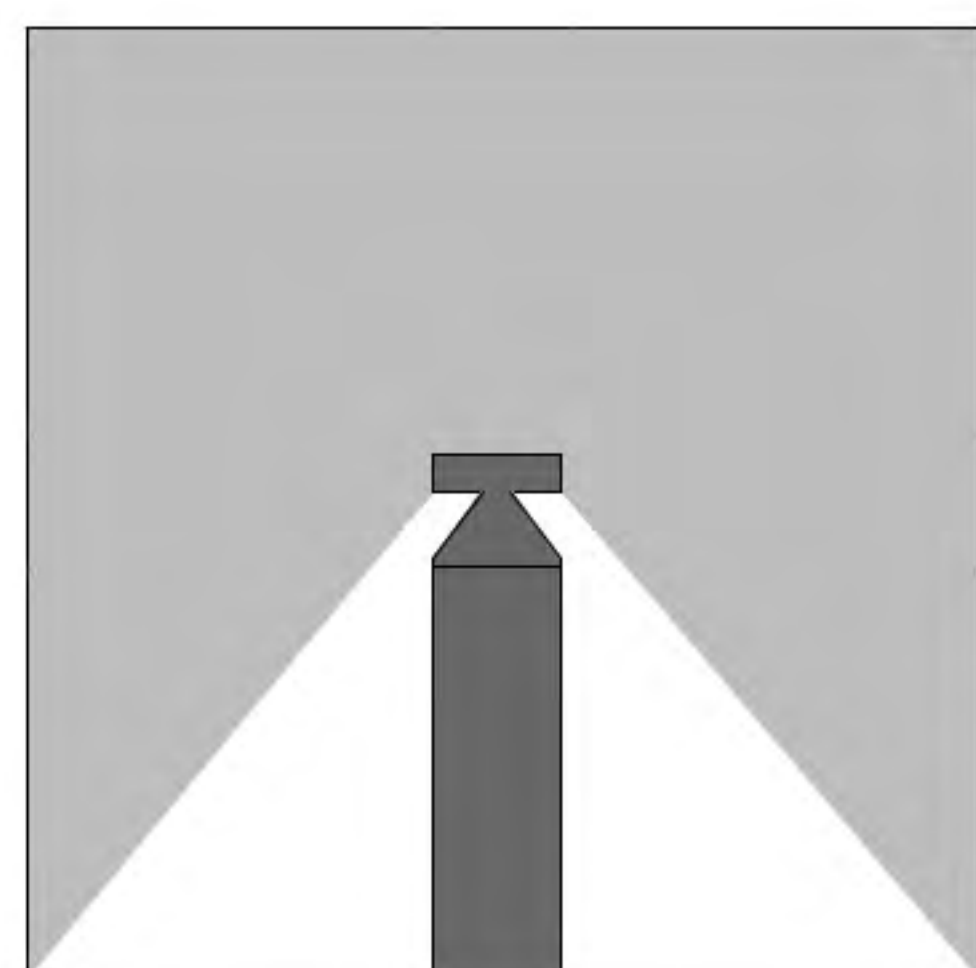

front view (正面图)

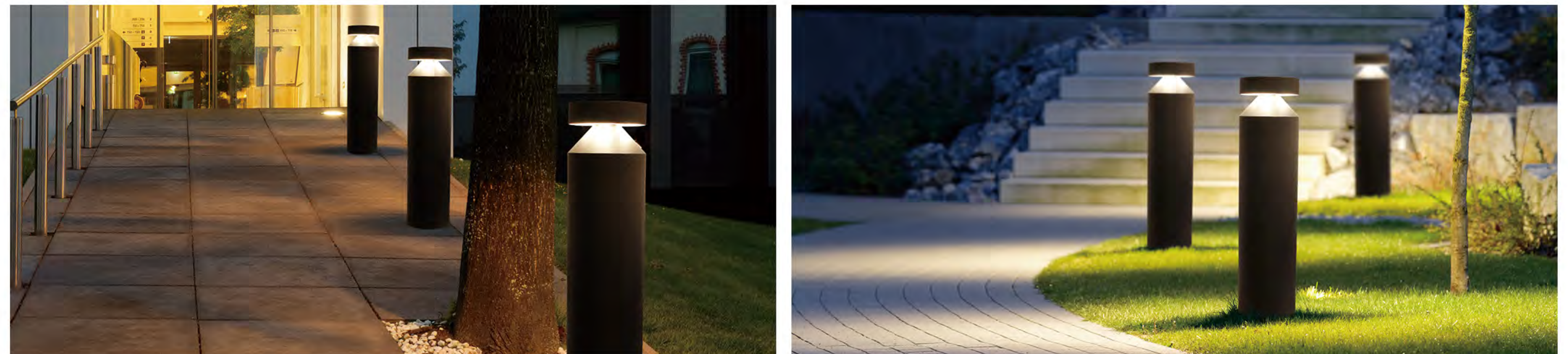

## Technical Date (技术参数)

Item No.	Lamp Type	Power	LM	CCT	PF	Voltage	CRI	A	B	C (mm)
MB23-020802	LED	20W	1400	2700K-6000K	0.95	AC110-265V	80-90	Ø200	60	200
MB23-020805	LED	20W	1400	2700K-6000K	0.95	AC110-265V	80-90	Ø200	360	500
MB23-020808	LED	20W	1400	2700K-6000K	0.95	AC110-265V	80-90	Ø200	660	800



# MB23-0209

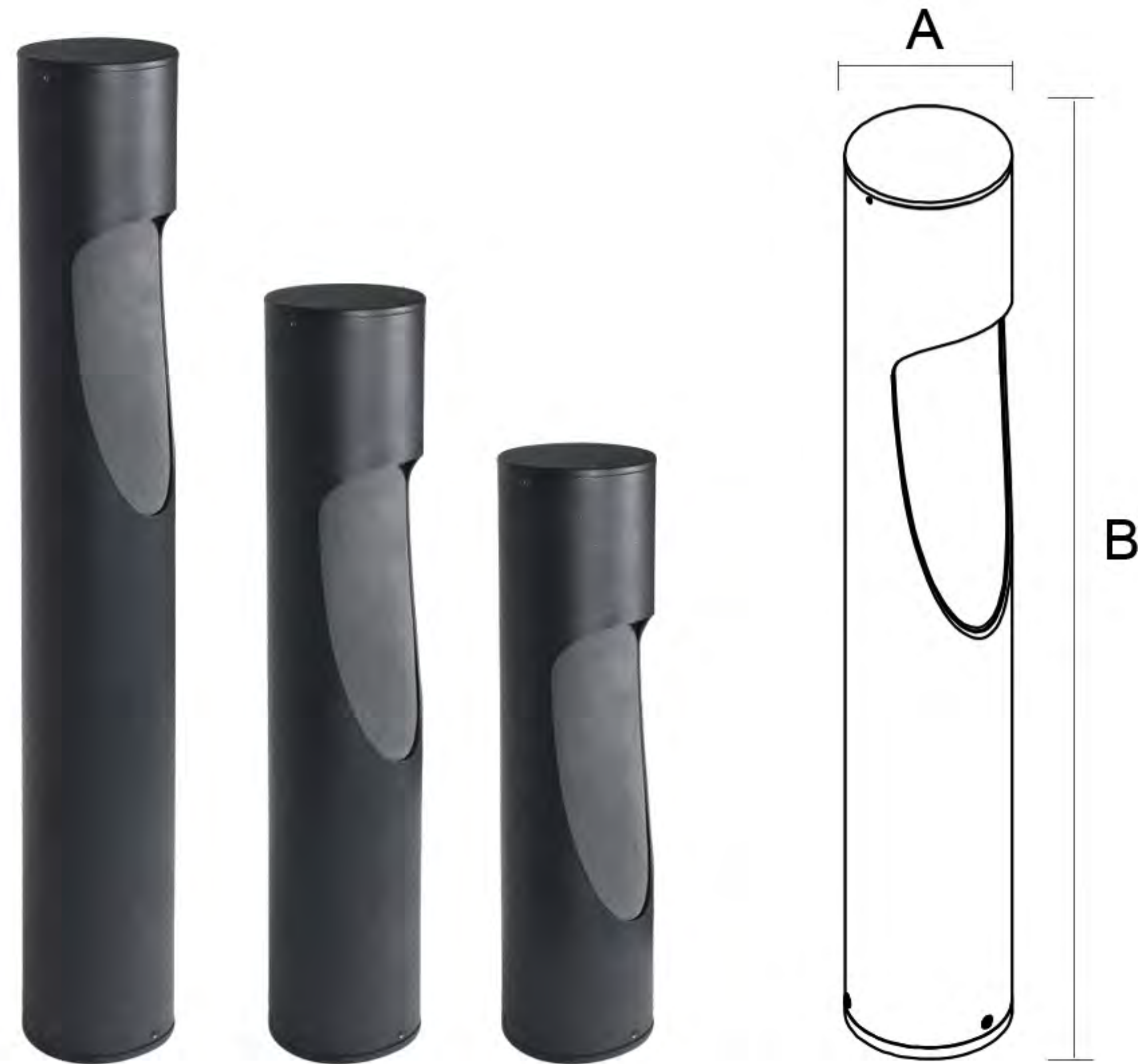

## Features&Benefit (功能和优点)

Category (品类)	Garden Light
Diffuser Material (扩散器材质)	Glass
Cover Material (面盖材质)	Aluminum
Operating mode (运行)	Built in
Steuerbar (开关)	On/Off
IP (防水等级)	54
Mounting type (安装类型)	Put
Mounting location (安装位置)	Overground
Application environment (应用环境)	Indoor/Outdoor
Body color (表面颜色)	Black/Dark Gray/Sliver Gray



## Product Description (产品描述)

Suitable for parks and gardens, neighborhoods, villas, city squares, pedestrian streets, scenic spots or resorts and other various scenes; lawn lamps can be a variety of heights at the same time the lighting effect will be different, more to provide a choice.

## Lightmap (光影图)

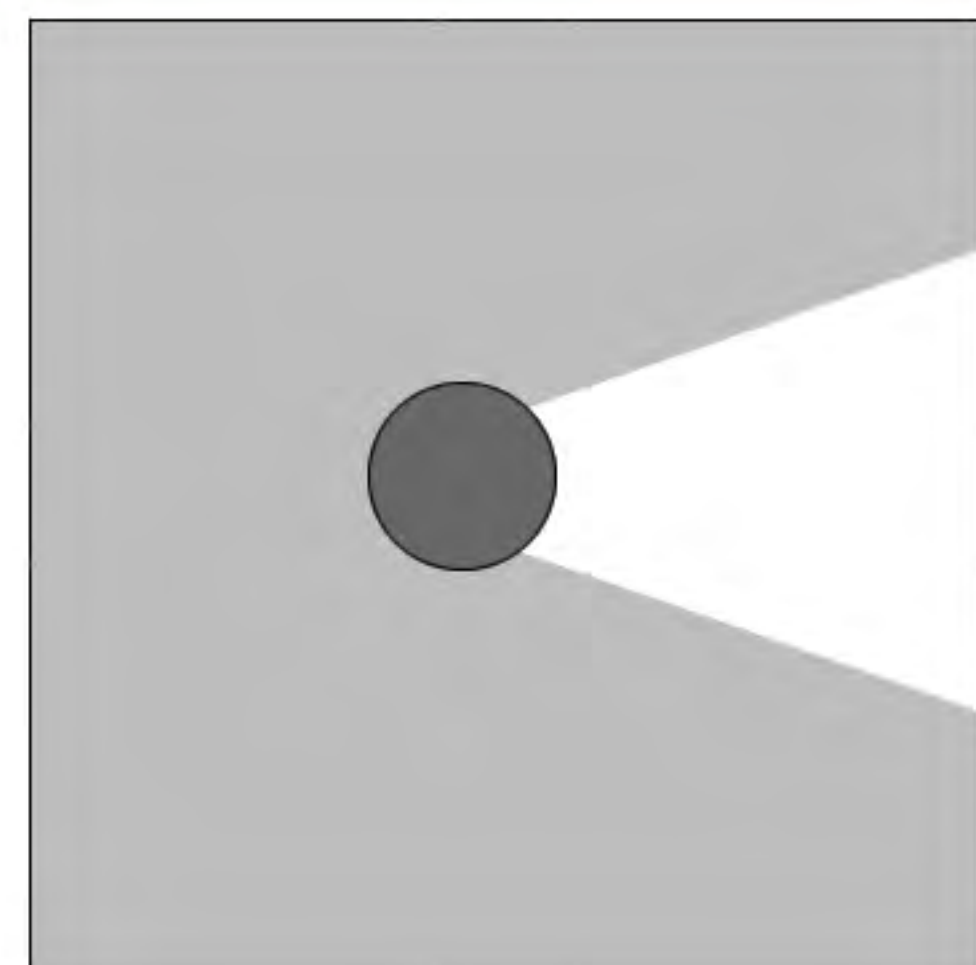

top view (俯视图)

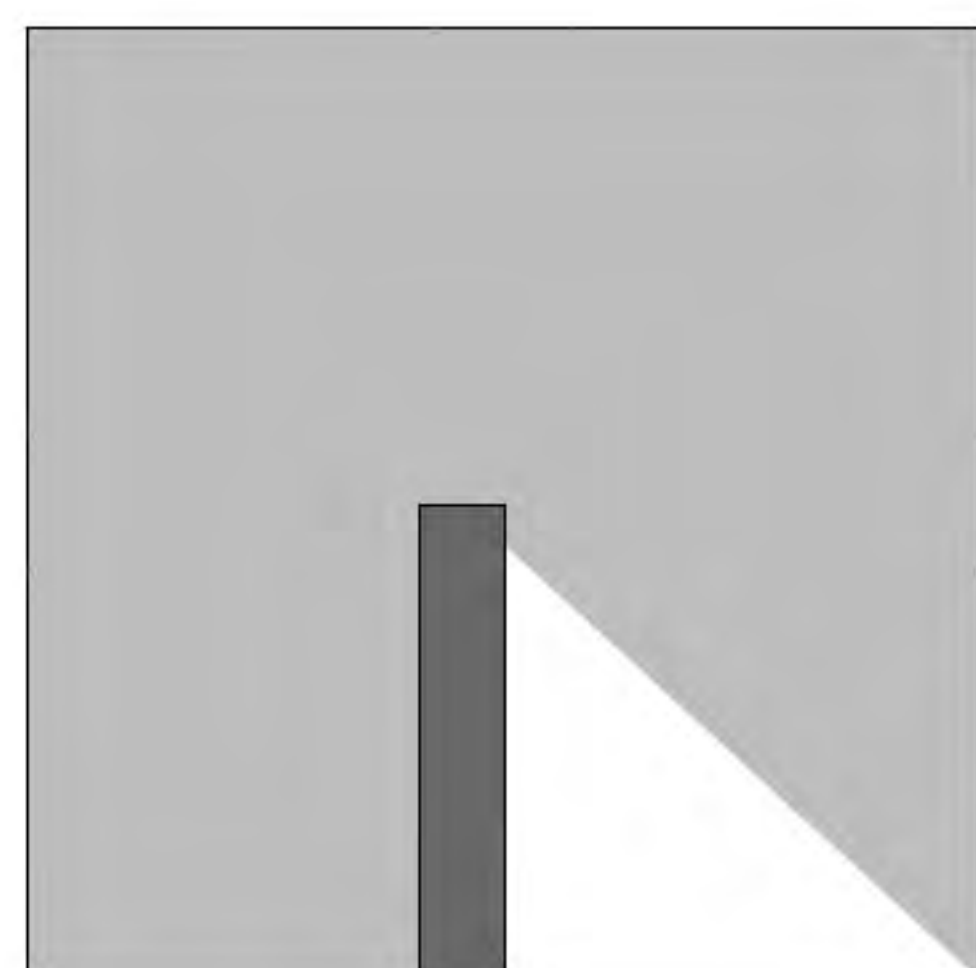

front view (正面图)

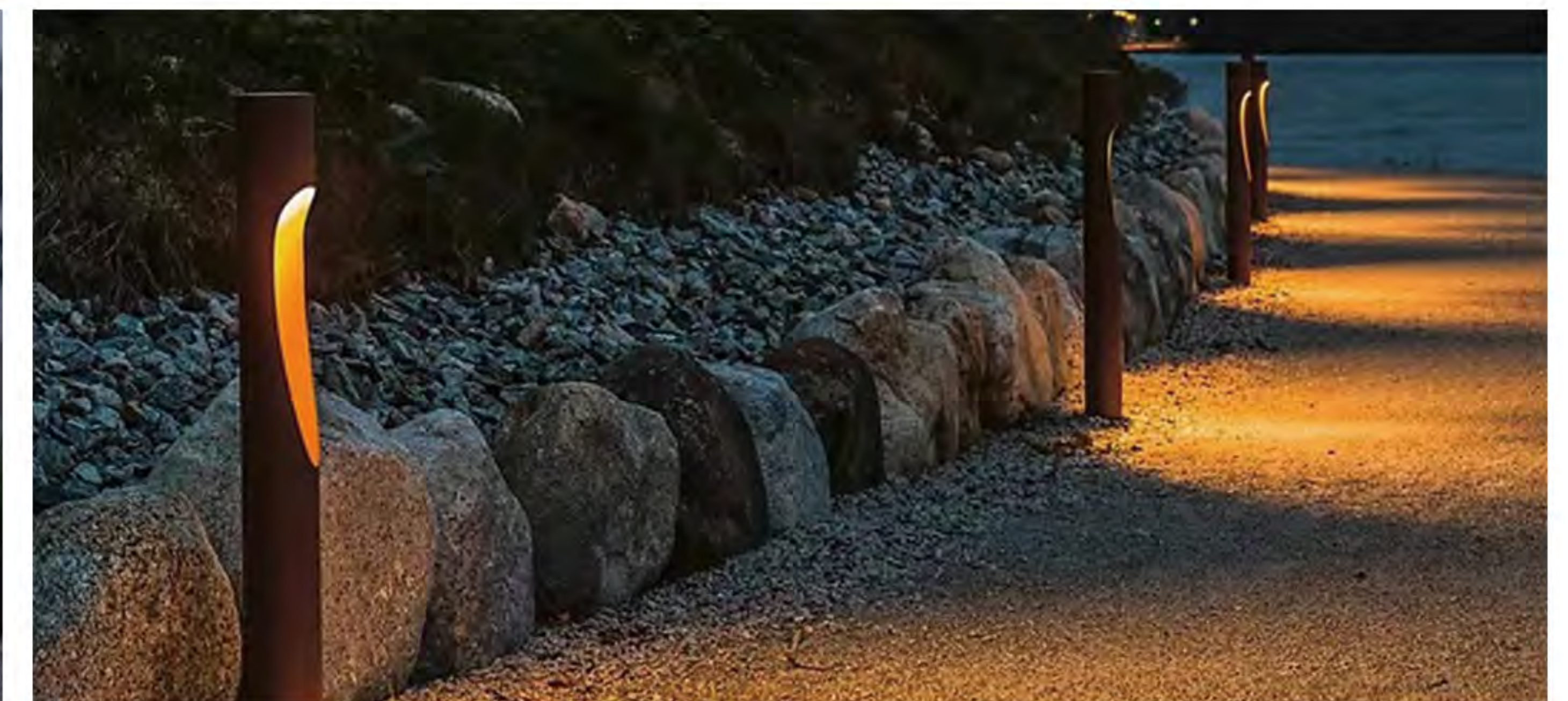
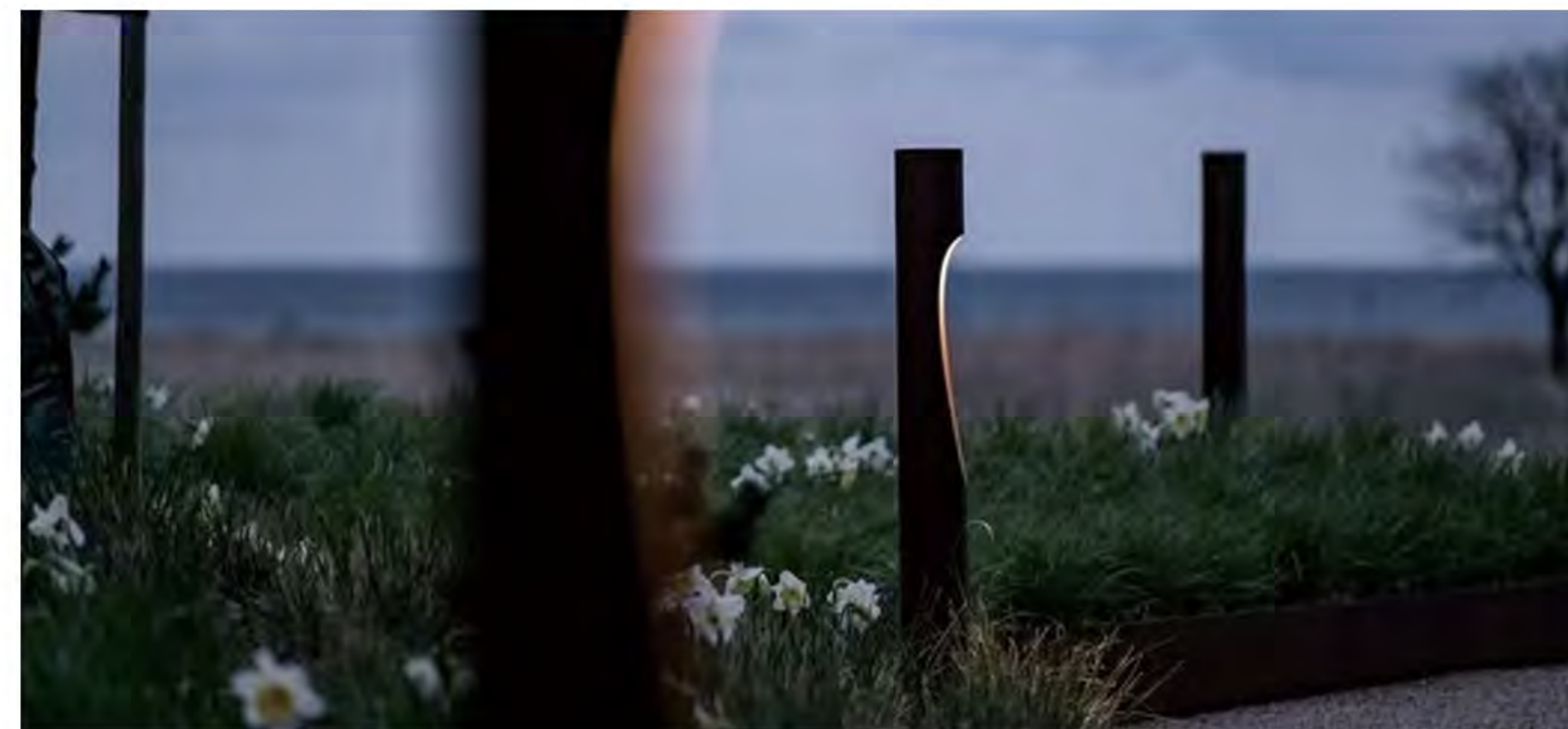

## Technical Date (技术参数)

Item No.	Lamp Type	Power	LM	CCT	PF	Voltage	CRI	A	B	C (mm)
MB23-020904	LED	10W	700	2700K-6000K	0.6	AC110-265V	80-90	Ø120	450	-
MB23-020906	LED	10W	700	2700K-6000K	0.6	AC110-265V	80-90	Ø120	600	-
MB23-020908	LED	10W	700	2700K-6000K	0.6	AC110-265V	80-90	Ø120	800	-



# MB23-0210

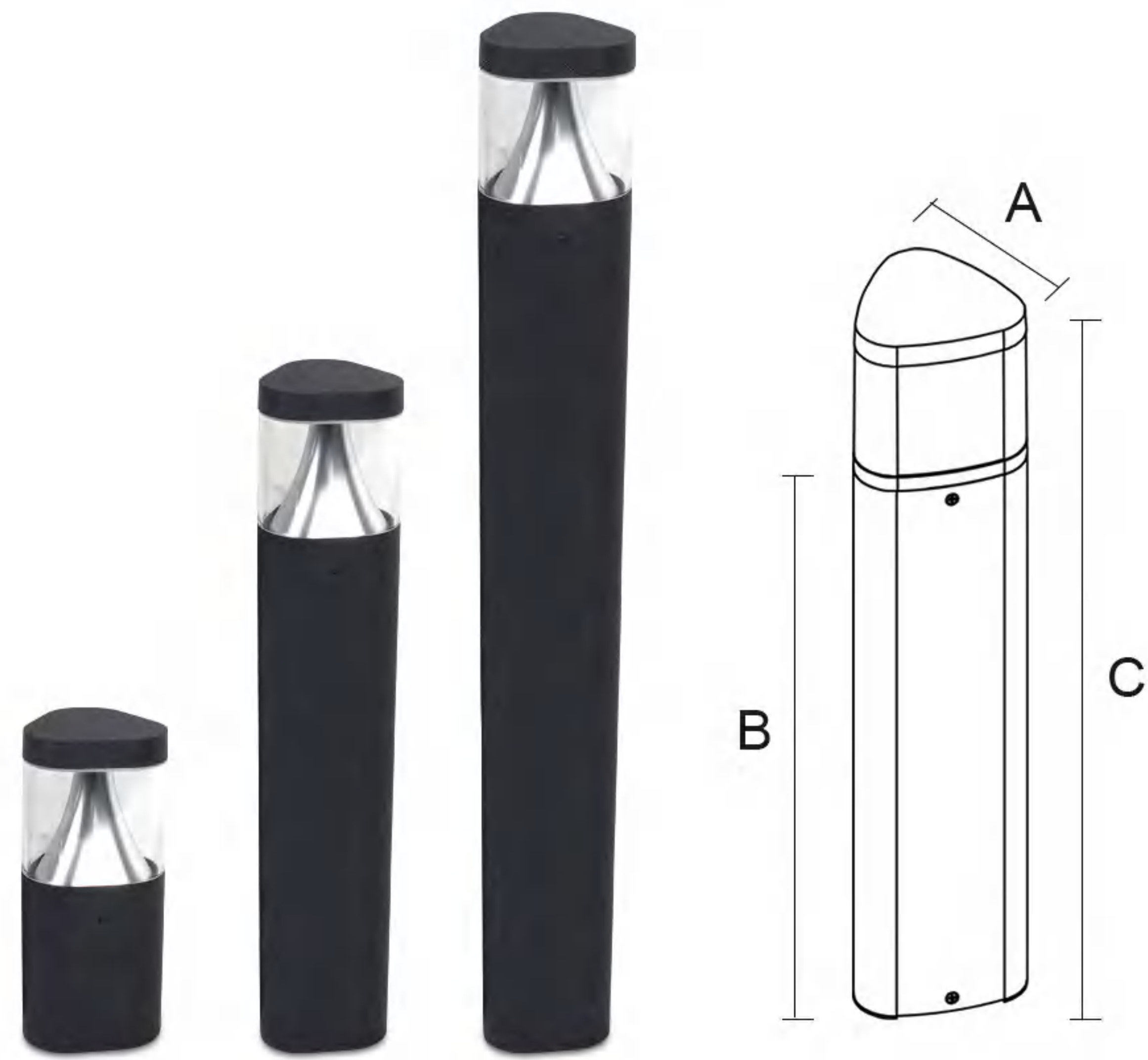

## Features&Benefit (功能和优点)

Category (品类)	Garden Light
Diffuser Material (扩散器材质)	PC
Cover Material (面盖材质)	Aluminum
Operating mode (运行)	Built in
Steuerbar (开关)	On/Off
IP (防水等级)	54
Mounting type (安装类型)	Put
Mounting location (安装位置)	Overground
Application environment (应用环境)	Indoor/Outdoor
Body color (表面颜色)	Black/Dark Gray/Sliver Gray



## Product Description (产品描述)

Suitable for parks and gardens, neighborhoods, villas, city squares, pedestrian streets, scenic spots or resorts and other various scenes; lawn lamps can be a variety of heights at the same time the lighting effect will be different, more to provide a choice.

## Lightmap (光影图)

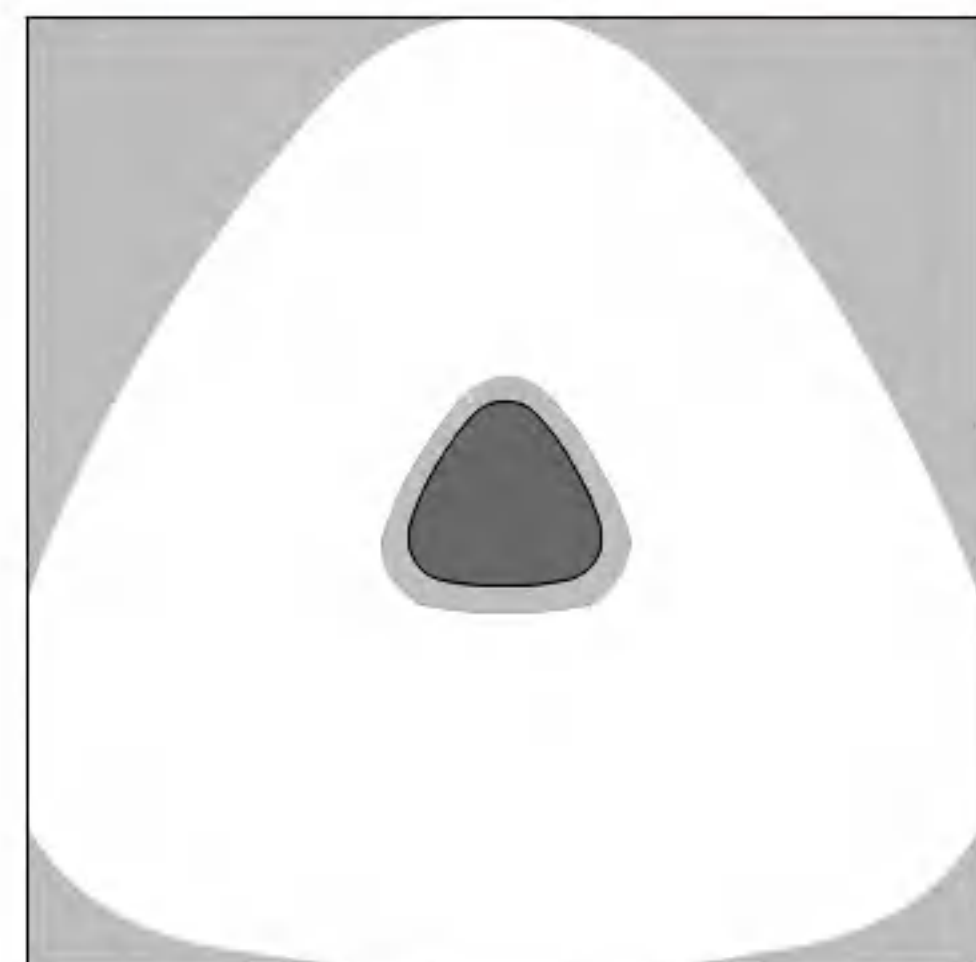

top view (俯视图)

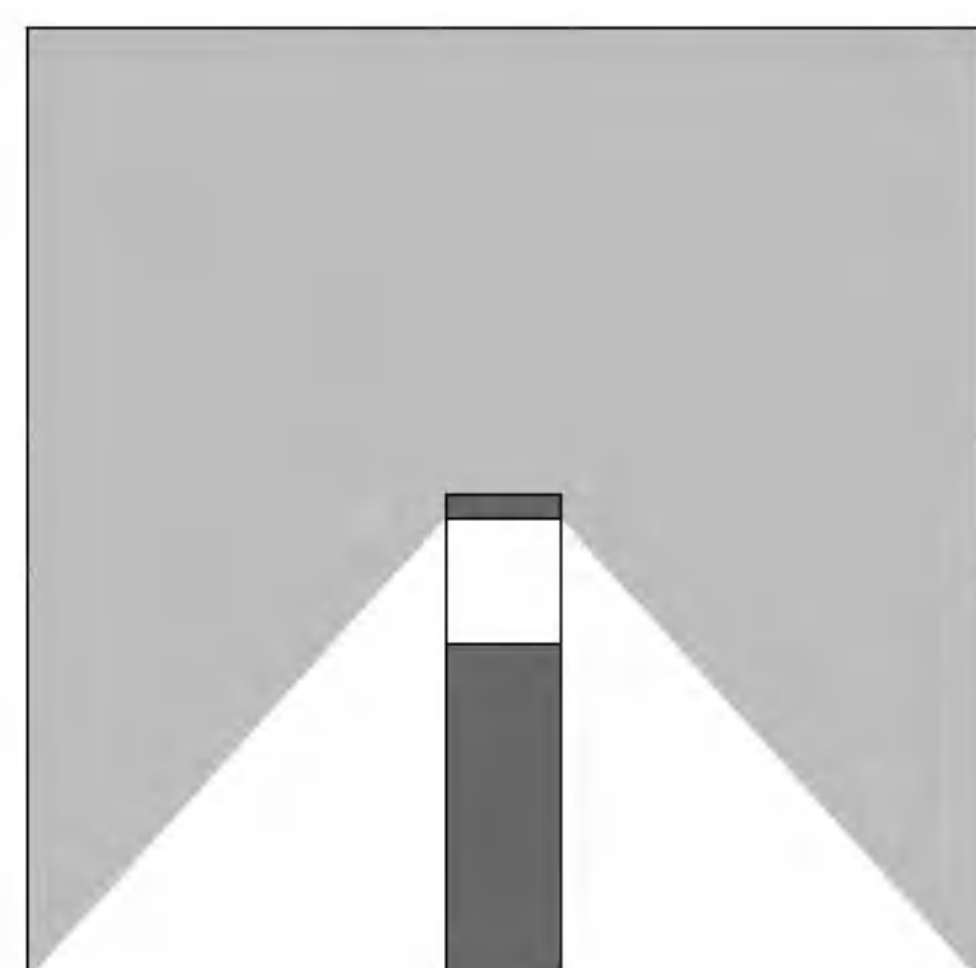

front view (正面图)



## Technical Date (技术参数)

Item No.	Lamp Type	Power	LM	CCT	PF	Voltage	CRI	A	B	C (mm)
MB23-021003	LED	10W	700	2700K-6000K	0.6	AC110-265V	80-90	90	200	300
MB23-021006	LED	10W	700	2700K-6000K	0.6	AC110-265V	80-90	90	500	600
MB23-021009	LED	10W	700	2700K-6000K	0.6	AC110-265V	80-90	90	800	900
MB23-021103	LED	10W	700	2700K-6000K	0.6	AC110-265V	80-90	125	170	300
MB23-021106	LED	10W	700	2700K-6000K	0.6	AC110-265V	80-90	125	470	600
MB23-021109	LED	10W	700	2700K-6000K	0.6	AC110-265V	80-90	125	770	900



# MB23-0212

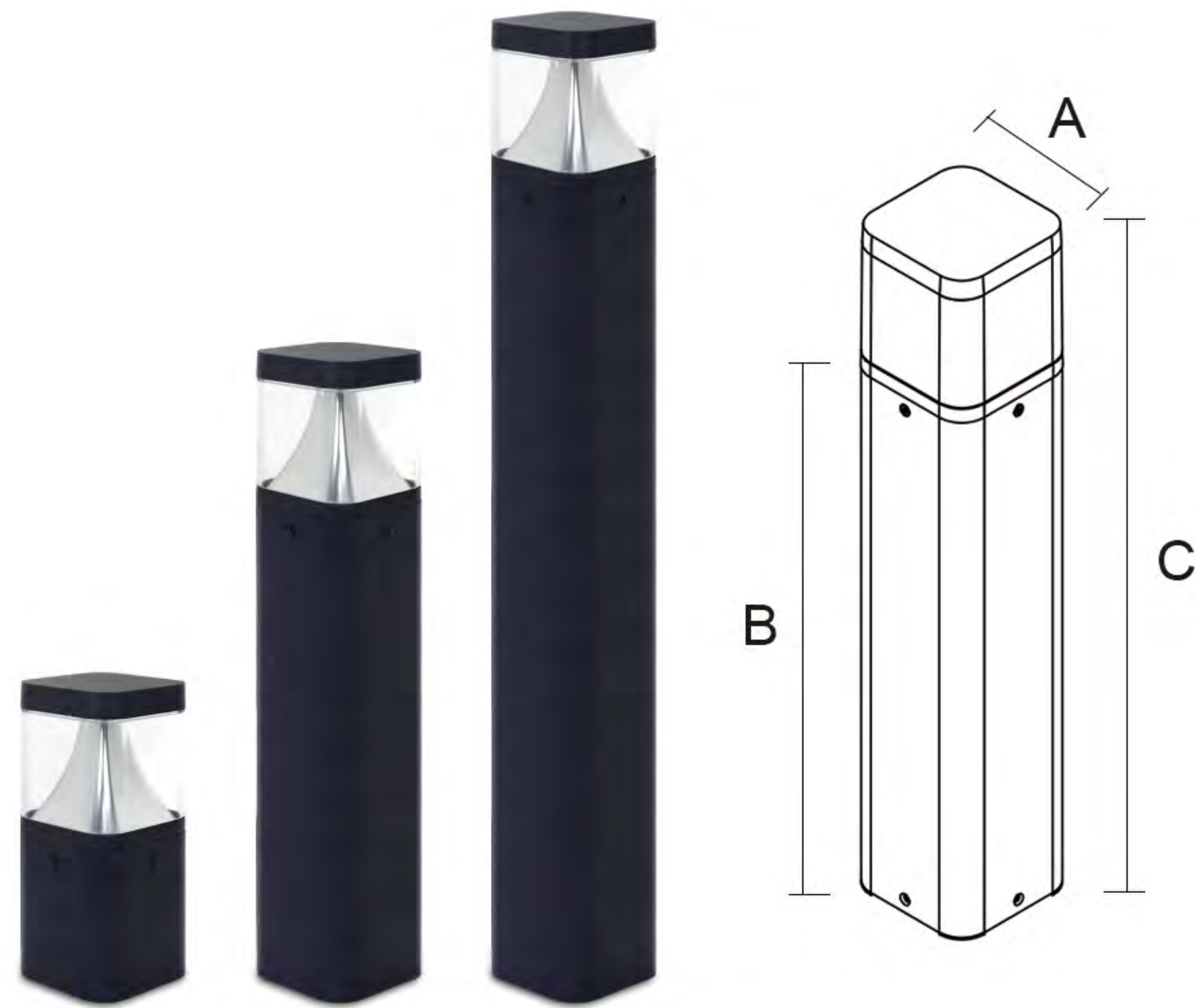

## Features&Benefit (功能和优点)

Category (品类)	Garden Light
Diffuser Material (扩散器材质)	PC
Cover Material (面盖材质)	Aluminum
Operating mode (运行)	Built in
Steuerbar (开关)	On/Off
IP (防水等级)	54
Mounting type (安装类型)	Put
Mounting location (安装位置)	Overground
Application environment (应用环境)	Indoor/Outdoor
Body color (表面颜色)	Black/Dark Gray/Sliver Gray



## Product Description (产品描述)

Suitable for parks and gardens, neighborhoods, villas, city squares, pedestrian streets, scenic spots or resorts and other various scenes; lawn lamps can be a variety of heights at the same time the lighting effect will be different, more to provide a choice.

## Lightmap (光影图)

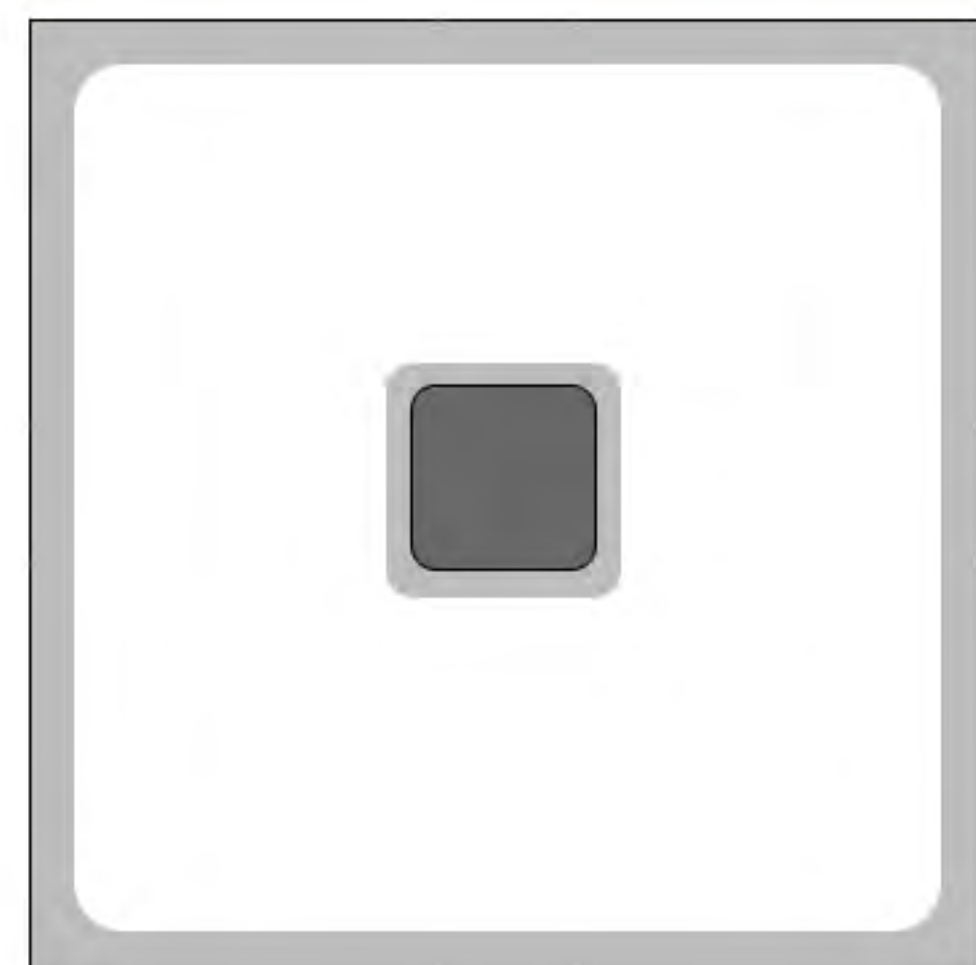

top view (俯视图)

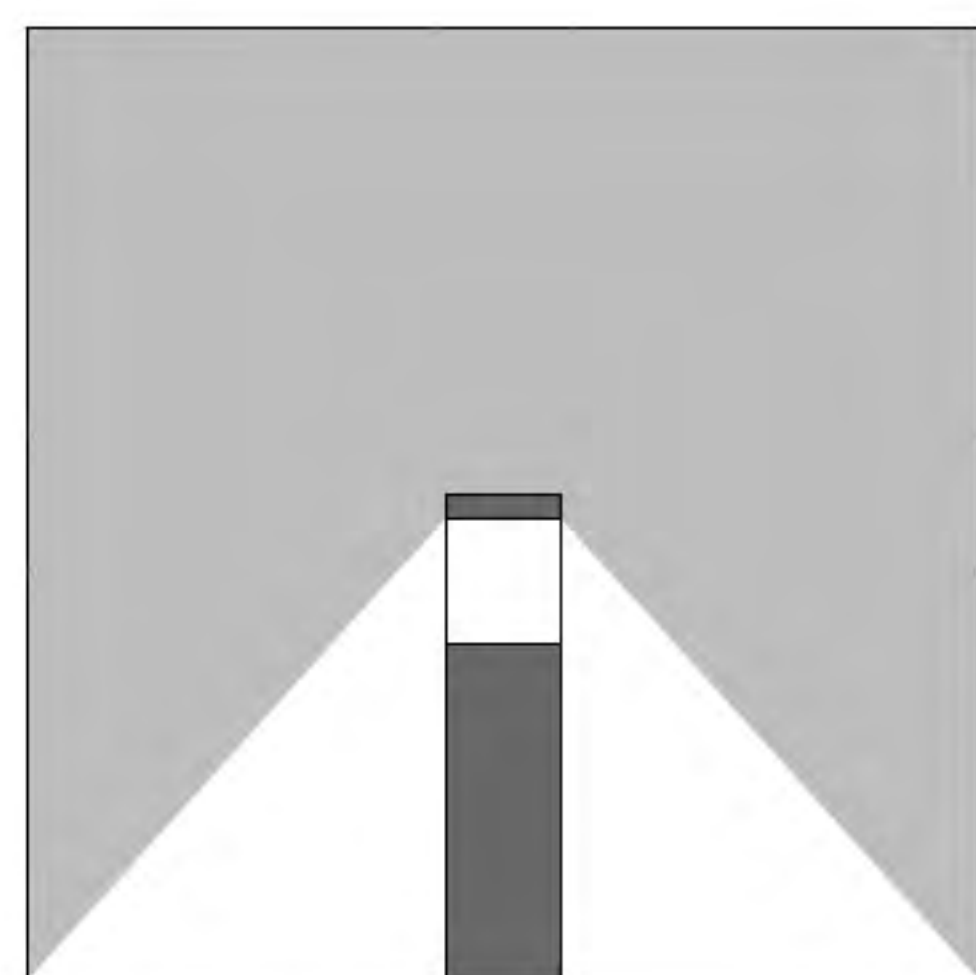

front view (正面图)



## Technical Date (技术参数)

Item No.	Lamp Type	Power	LM	CCT	PF	Voltage	CRI	A	B	C (mm)
MB23-021203	LED	10W	700	2700K-6000K	0.6	AC110-265V	80-90	90	200	300
MB23-021206	LED	10W	700	2700K-6000K	0.6	AC110-265V	80-90	90	500	600
MB23-021209	LED	10W	700	2700K-6000K	0.6	AC110-265V	80-90	90	800	900
MB23-021303	LED	10W	700	2700K-6000K	0.6	AC110-265V	80-90	120	170	300
MB23-021306	LED	10W	700	2700K-6000K	0.6	AC110-265V	80-90	120	470	600
MB23-021309	LED	10W	700	2700K-6000K	0.6	AC110-265V	80-90	120	770	900



# MB23-0214

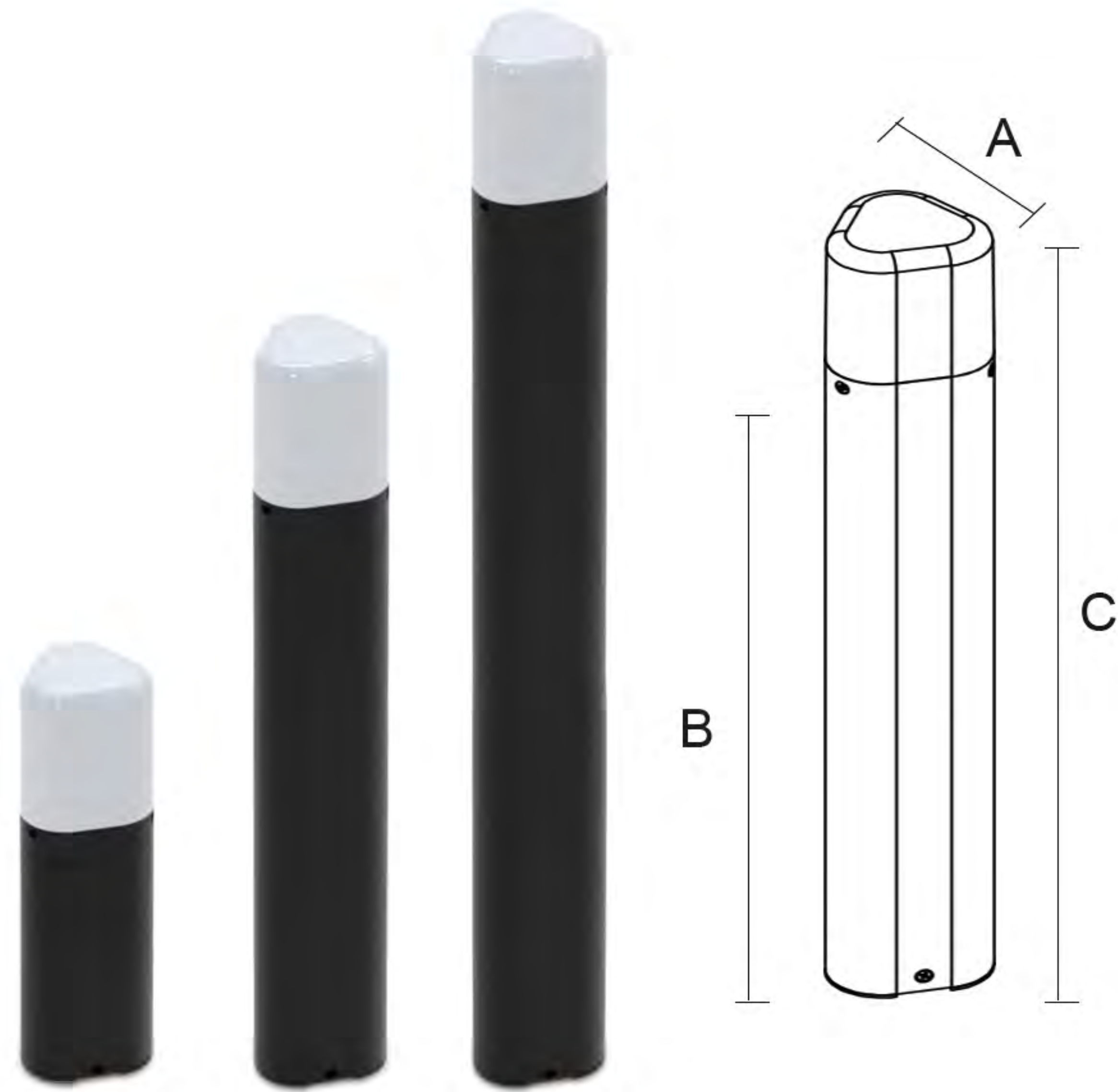

## Features&Benefit (功能和优点)

Category (品类)	Garden Light
Diffuser Material (扩散器材质)	PC
Cover Material (面盖材质)	Aluminum
Operating mode (运行)	Built in
Steuerbar (开关)	On/Off
IP (防水等级)	54
Mounting type (安装类型)	Put
Mounting location (安装位置)	Overground
Application environment (应用环境)	Indoor/Outdoor
Body color (表面颜色)	Black/Dark Gray/Sliver Gray



## Product Description (产品描述)

Suitable for parks and gardens, neighborhoods, villas, city squares, pedestrian streets, scenic spots or resorts and other various scenes; lawn lamps can be a variety of heights at the same time the lighting effect will be different, more to provide a choice.

## Lightmap (光影图)

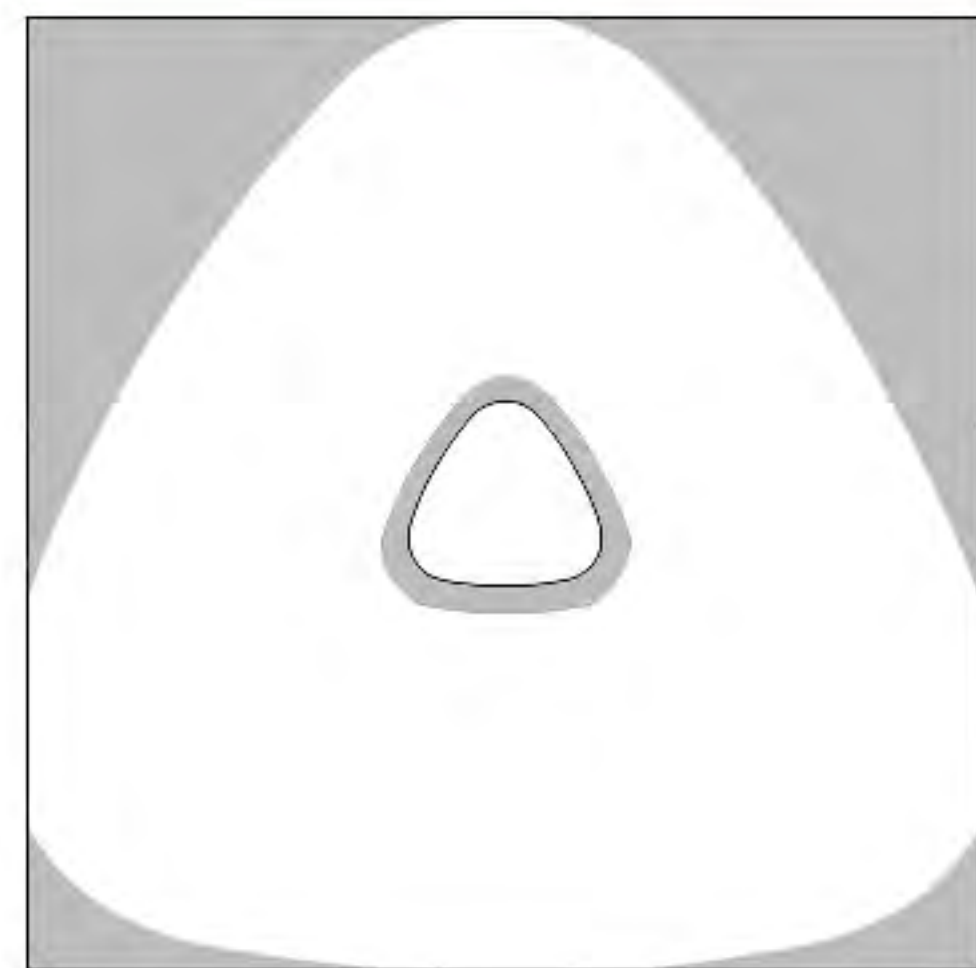

top view (俯视图)

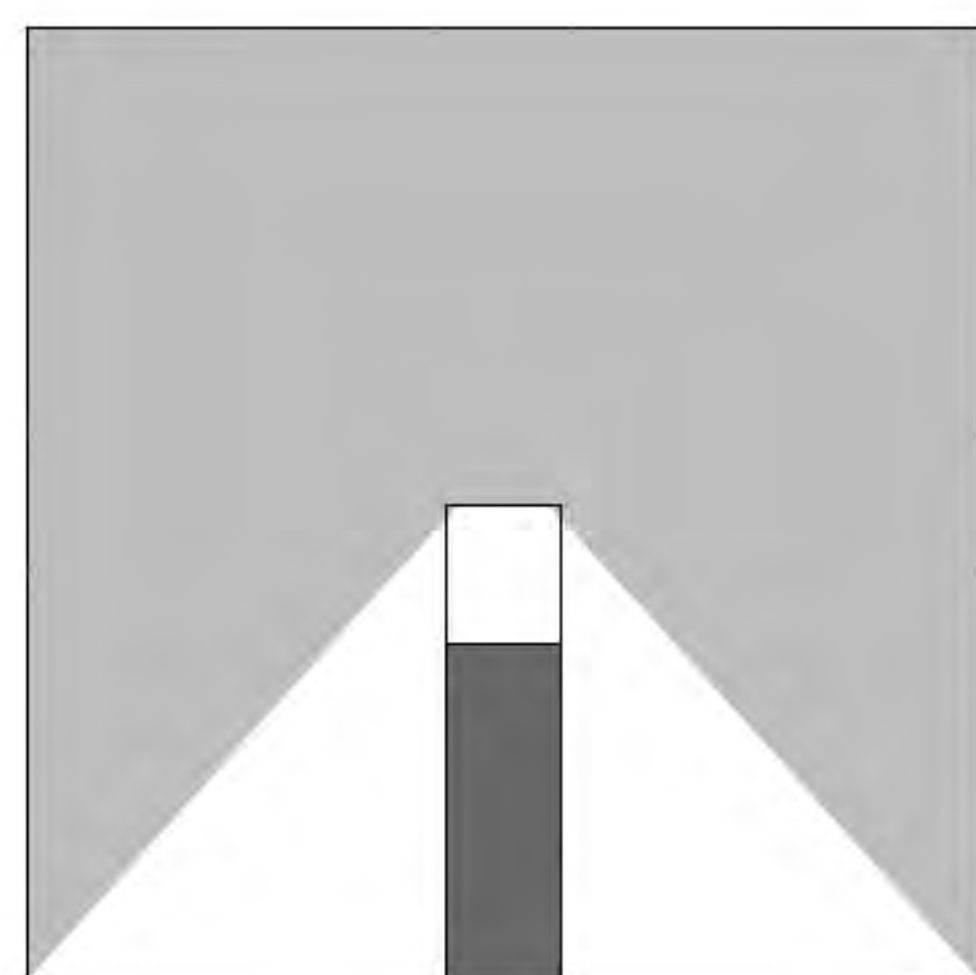

front view (正面图)



## Technical Date (技术参数)

Item No.	Lamp Type	Power	LM	CCT	PF	Voltage	CRI	A	B	C (mm)
MB23-021403	E14/GU10	-	-	-	-	-	-	90	200	300
MB23-021406	E14/GU10	-	-	-	-	-	-	90	500	600
MB23-021409	E14/GU10	-	-	-	-	-	-	90	800	900
MB23-021503	E27/GU10	-	-	-	-	-	-	125	140	300
MB23-021506	E27/GU10	-	-	-	-	-	-	125	440	600
MB23-021509	E27/GU10	-	-	-	-	-	-	125	740	900



# MB23-0216

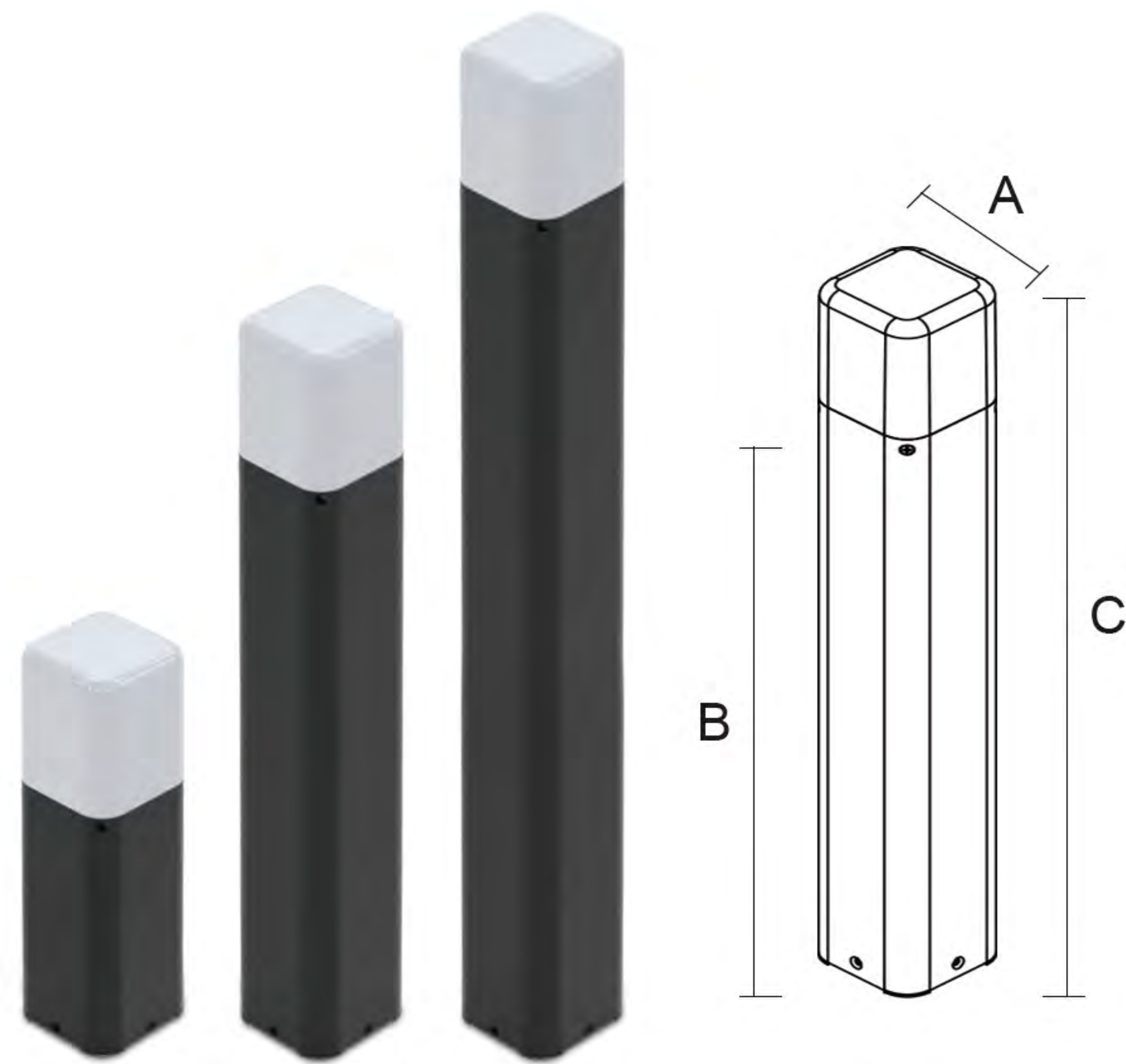

## Features&Benefit (功能和优点)

Category (品类)	Garden Light
Diffuser Material (扩散器材质)	PC
Cover Material (面盖材质)	Aluminum
Operating mode (运行)	Built in
Steuerbar (开关)	On/Off
IP (防水等级)	54
Mounting type (安装类型)	Put
Mounting location (安装位置)	Overground
Application environment (应用环境)	Indoor/Outdoor
Body color (表面颜色)	Black/Dark Gray/Sliver Gray



## Product Description (产品描述)

Suitable for parks and gardens, neighborhoods, villas, city squares, pedestrian streets, scenic spots or resorts and other various scenes; lawn lamps can be a variety of heights at the same time the lighting effect will be different, more to provide a choice.

## Lightmap (光影图)

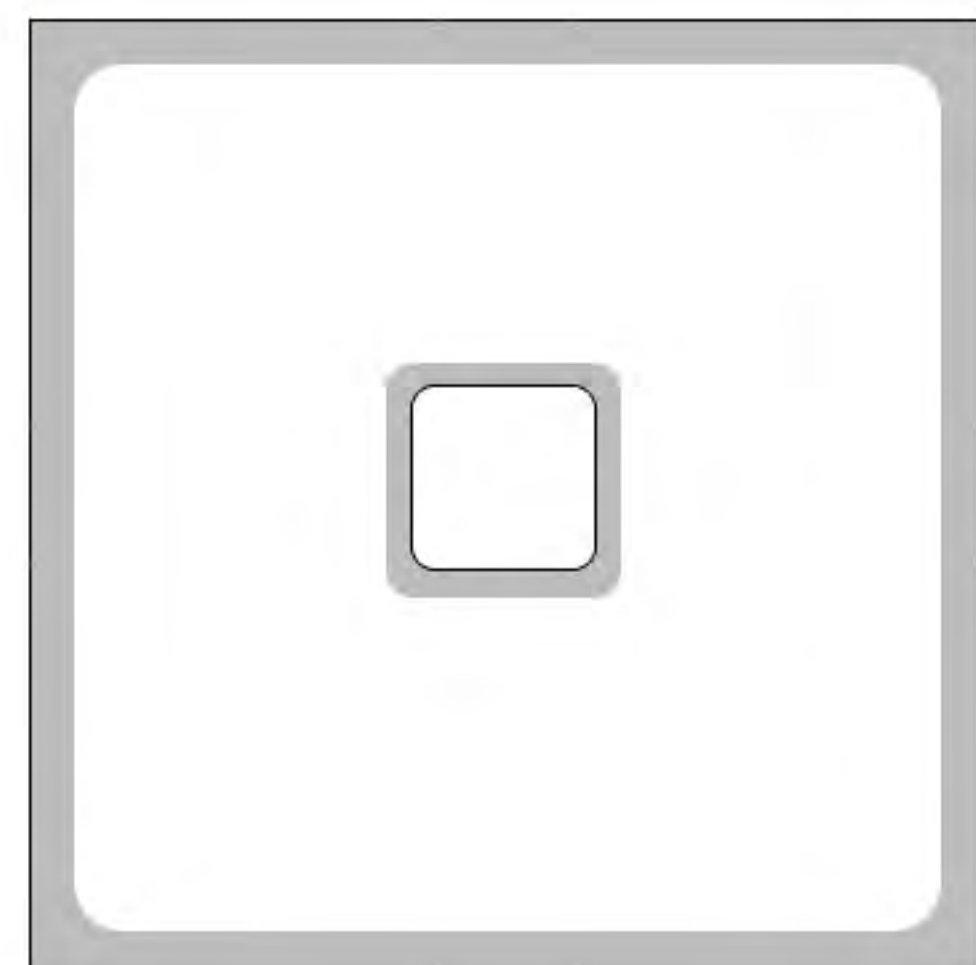

top view (俯视图)

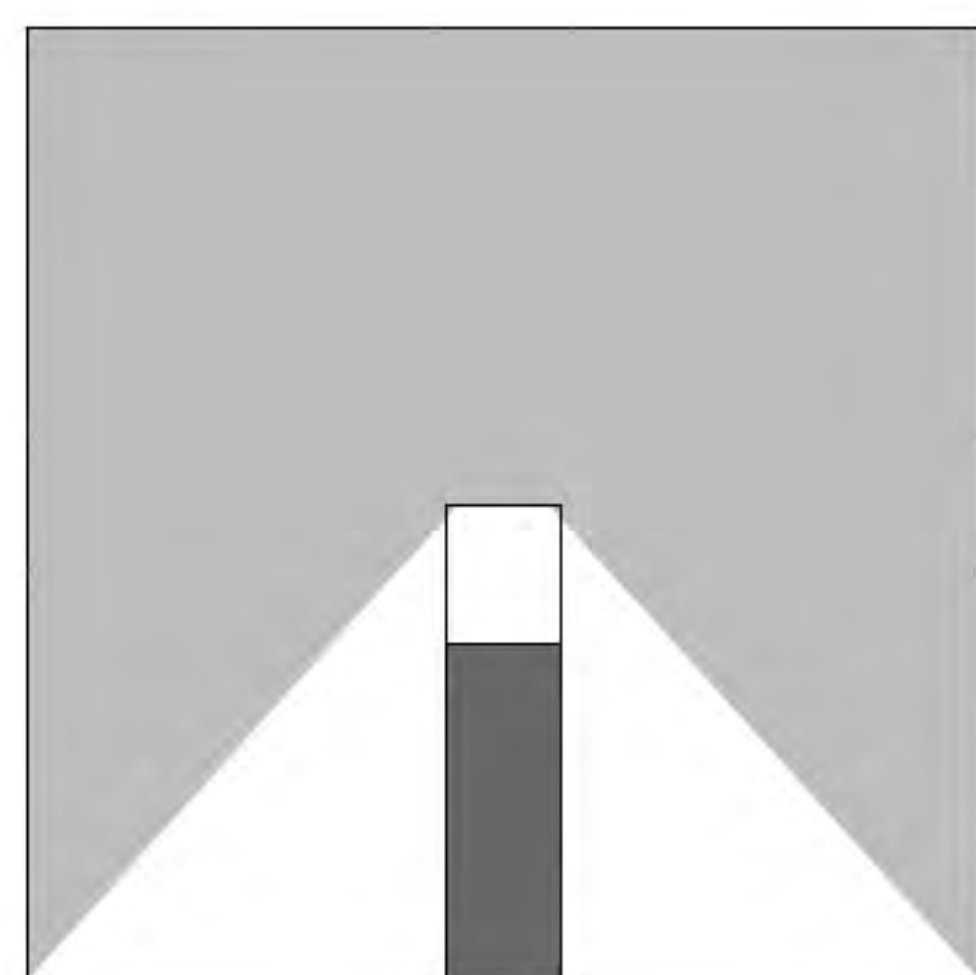

front view (正面图)



## Technical Date (技术参数)

Item No.	Lamp Type	Power	LM	CCT	PF	Voltage	CRI	A	B	C (mm)
MB23-021603	E14/GU10	-	-	-	-	-	-	90	200	300
MB23-021606	E14/GU10	-	-	-	-	-	-	90	500	600
MB23-021609	E14/GU10	-	-	-	-	-	-	90	800	900



# MB23-0218

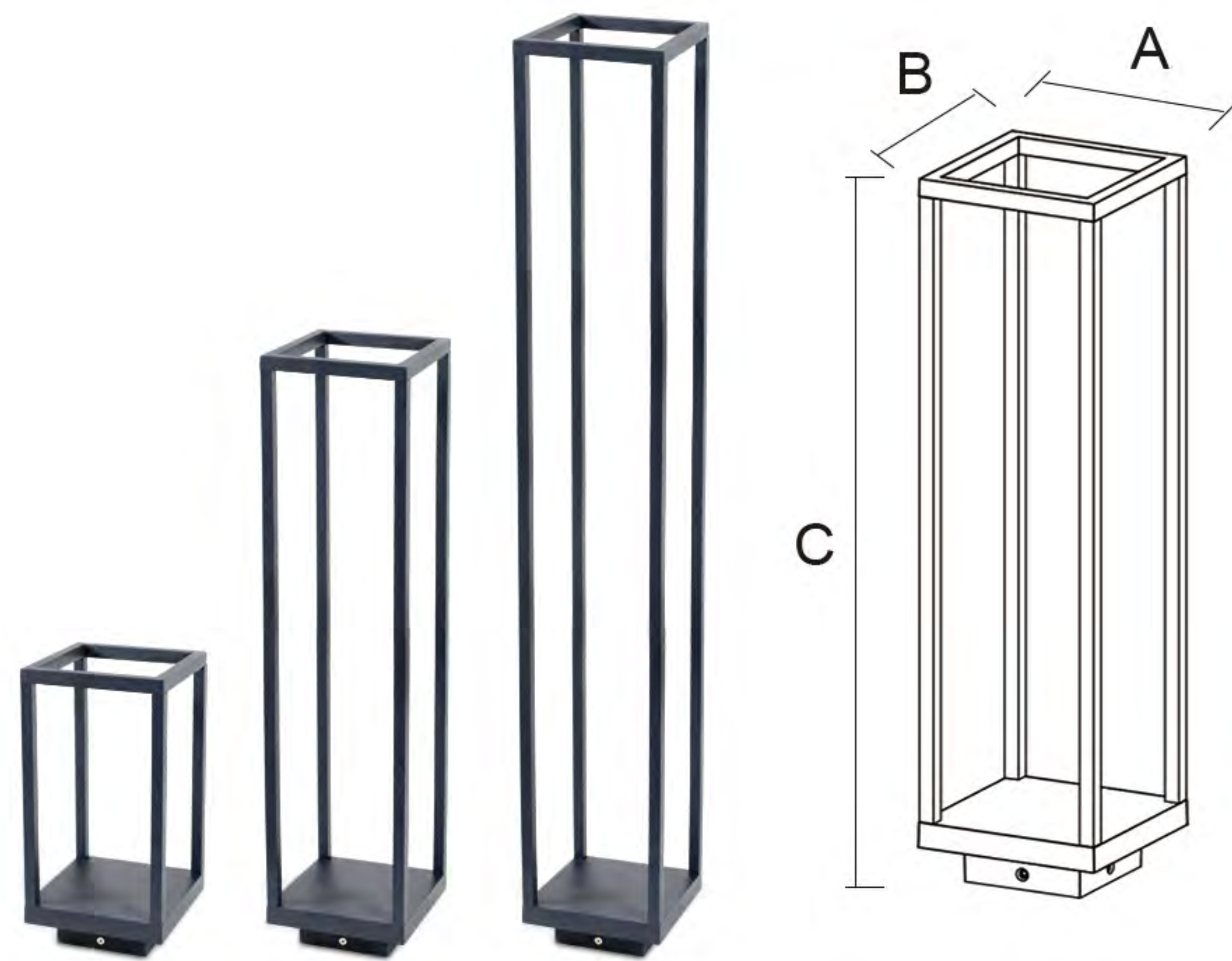

## Features&Benefit (功能和优点)

Category (品类)	Garden Light
Diffuser Material (扩散器材质)	PC
Cover Material (面盖材质)	Aluminum
Operating mode (运行)	Built in
Steuerbar (开关)	On/Off
IP (防水等级)	54
Mounting type (安装类型)	Put
Mounting location (安装位置)	Overground
Application environment (应用环境)	Indoor/Outdoor
Body color (表面颜色)	Black/Dark Gray/Sliver Gray



## Product Description (产品描述)

Suitable for parks and gardens, neighborhoods, villas, city squares, pedestrian streets, scenic spots or resorts and other various scenes; lawn lamps can be a variety of heights at the same time the lighting effect will be different, more to provide a choice.

## Lightmap (光影图)

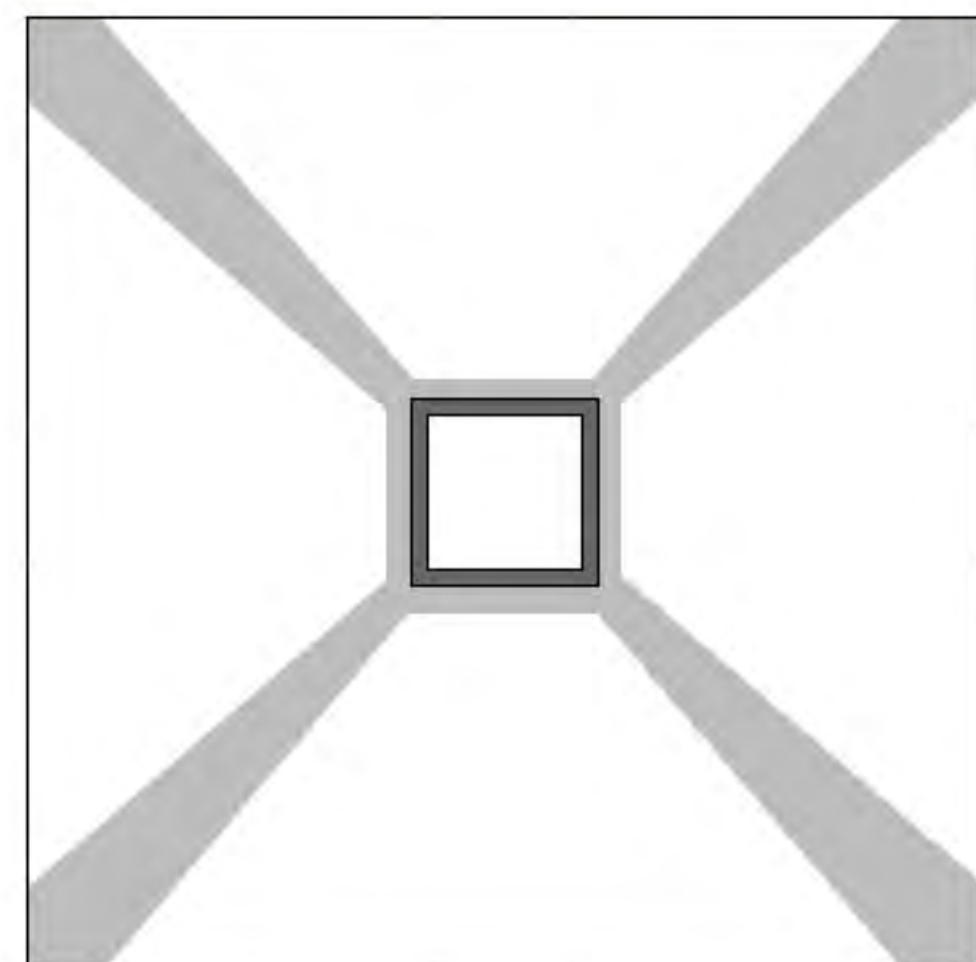

top view (俯视图)

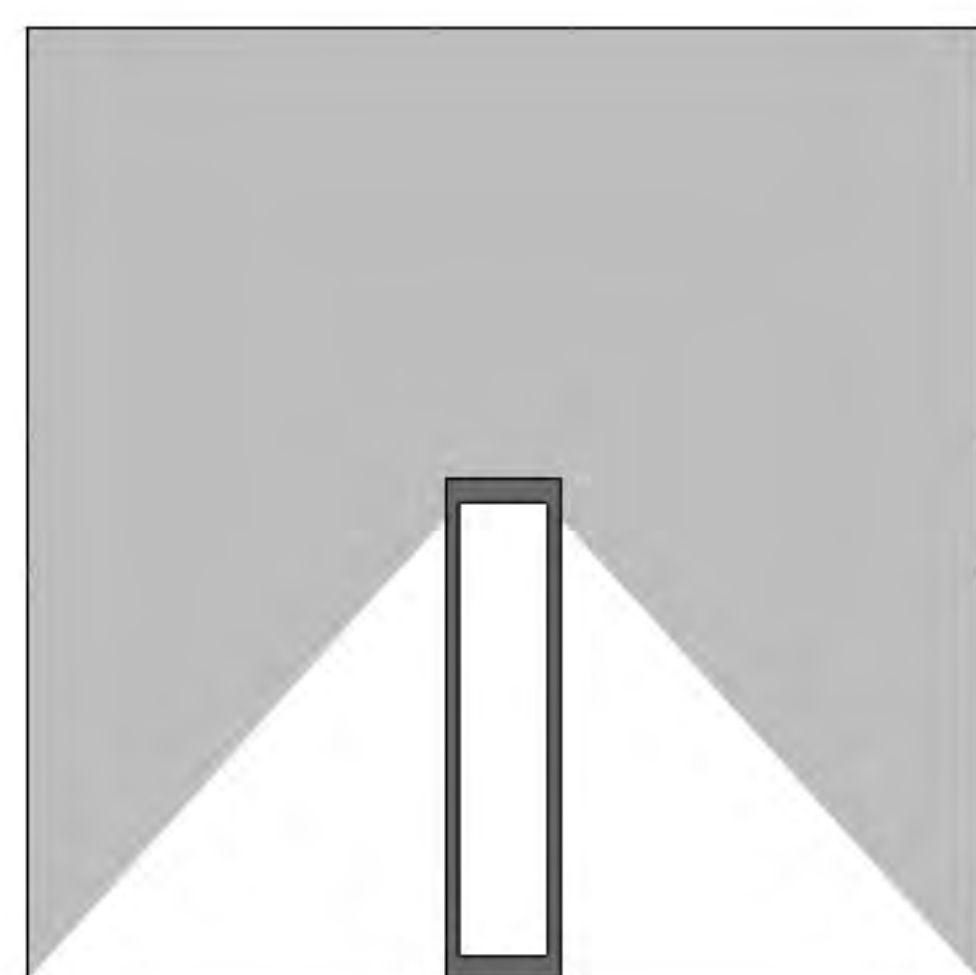

front view (正面图)



## Technical Date (技术参数)

Item No.	Lamp Type	Power	LM	CCT	PF	Voltage	CRI	A	B	C (mm)
MB23-021803	LED	8W	560	2700K-6000K	0.6	AC110-265V	80-90	150	150	300
MB23-021806	LED	8W	560	2700K-6000K	0.6	AC110-265V	80-90	150	150	600
MB23-021809	LED	8W	560	2700K-6000K	0.6	AC110-265V	80-90	150	150	900



# MB23-0219

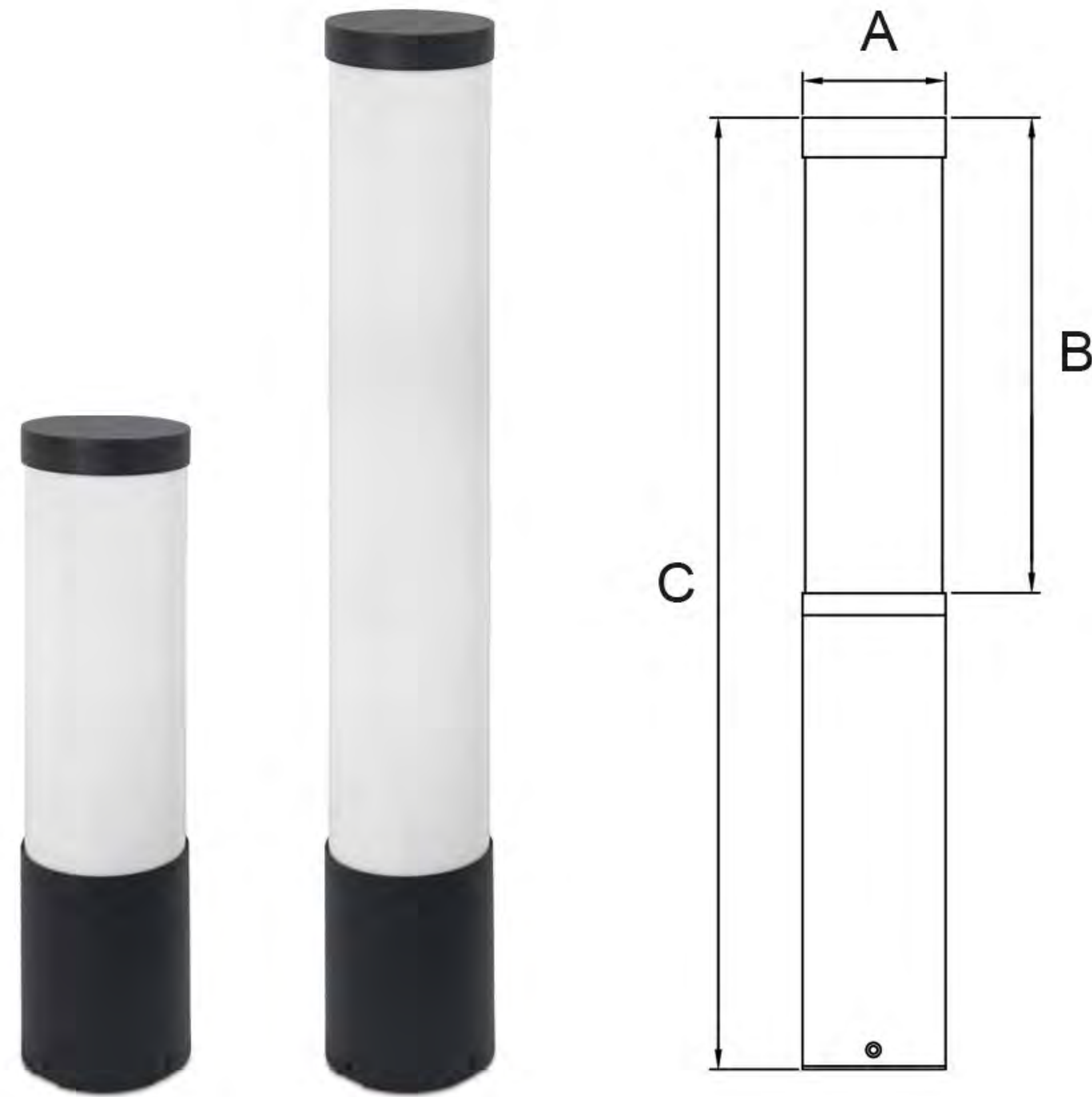

## Features&Benefit (功能和优点)

Category (品类)	Garden Light
Diffuser Material (扩散器材质)	Acrylic
Cover Material (面盖材质)	Aluminum
Operating mode (运行)	Built in
Steuerbar (开关)	On/Off
IP (防水等级)	54
Mounting type (安装类型)	Put
Mounting location (安装位置)	Overground
Application environment (应用环境)	Indoor/Outdoor
Body color (表面颜色)	Black/Dark Gray/Sliver Gray



## Product Description (产品描述)

Suitable for parks and gardens, neighborhoods, villas, city squares, pedestrian streets, scenic spots or resorts and other various scenes; lawn lamps can be a variety of heights at the same time the lighting effect will be different, more to provide a choice.

## Lightmap (光影图)



top view (俯视图)

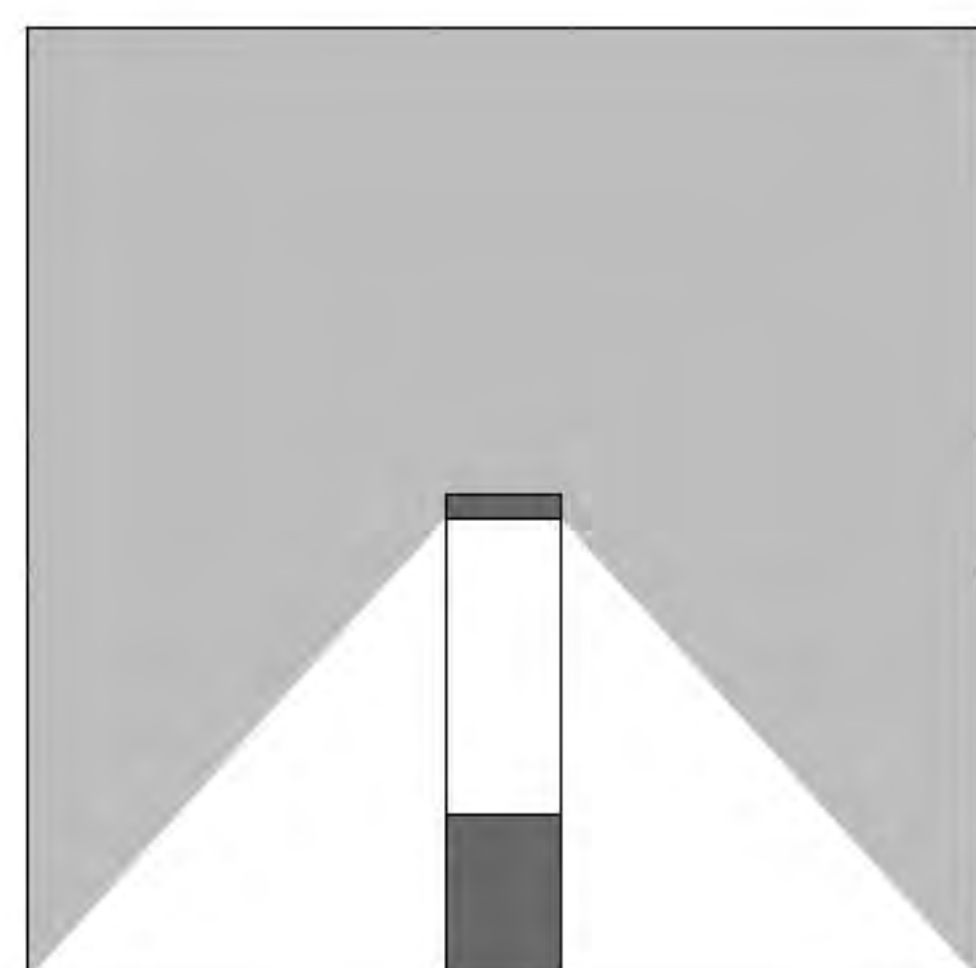

front view (正面图)

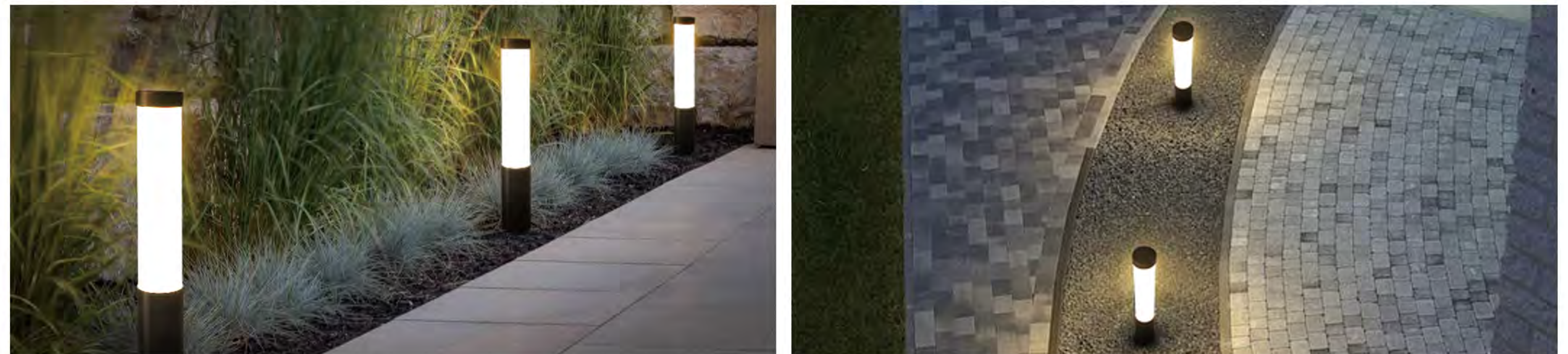

## Technical Date (技术参数)

Item No.	Lamp Type	Power	LM	CCT	PF	Voltage	CRI	A	B	C (mm)
MB23-021906	LED	15W	1050	2700K-6000K	0.6	AC110-265V	80-90	Ø90	380	600
MB23-021910	LED	20W	1400	2700K-6000K	0.6	AC110-265V	80-90	Ø90	780	1000
MB23-022006	LED	15W	1050	2700K-6000K	0.6	AC110-265V	80-90	Ø108	380	600
MB23-022010	LED	20W	1400	2700K-6000K	0.6	AC110-265V	80-90	Ø108	780	1000
MB23-022106	LED	15W	1050	2700K-6000K	0.6	AC110-265V	80-90	Ø145	380	600
MB23-022110	LED	20W	1400	2700K-6000K	0.6	AC110-265V	80-90	Ø145	780	1000



# MB23-0222

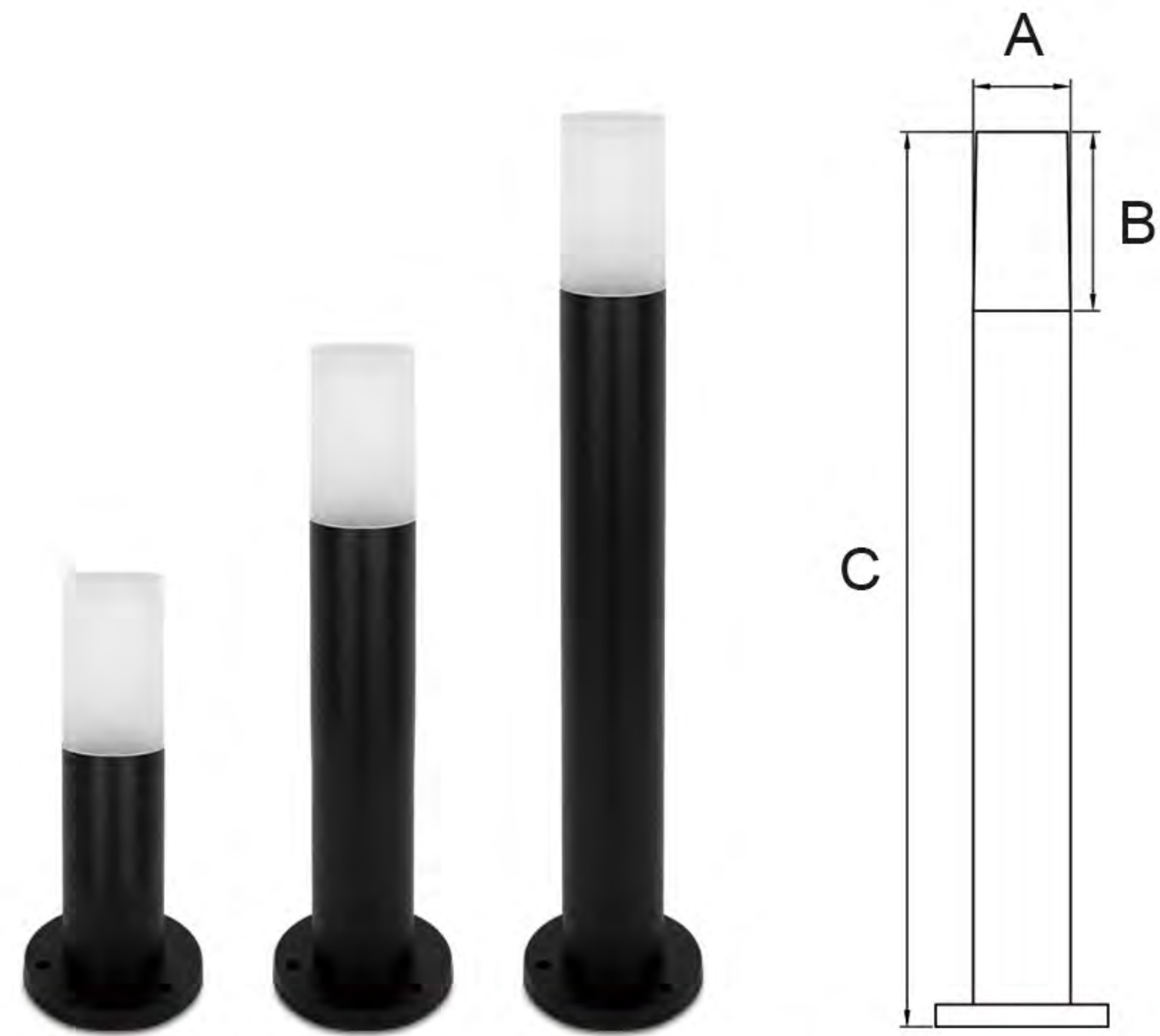

## Features&Benefit (功能和优点)

Category (品类)	Garden Light
Diffuser Material (扩散器材质)	Acrylic
Cover Material (面盖材质)	Aluminum
Operating mode (运行)	Built in
Steuerbar (开关)	On/Off
IP (防水等级)	54
Mounting type (安装类型)	Put
Mounting location (安装位置)	Overground
Application environment (应用环境)	Indoor/Outdoor
Body color (表面颜色)	Black/Dark Gray/Sliver Gray



## Product Description (产品描述)

Suitable for parks and gardens, neighborhoods, villas, city squares, pedestrian streets, scenic spots or resorts and other various scenes; lawn lamps can be a variety of heights at the same time the lighting effect will be different, more to provide a choice.

## Lightmap (光影图)



top view (俯视图)

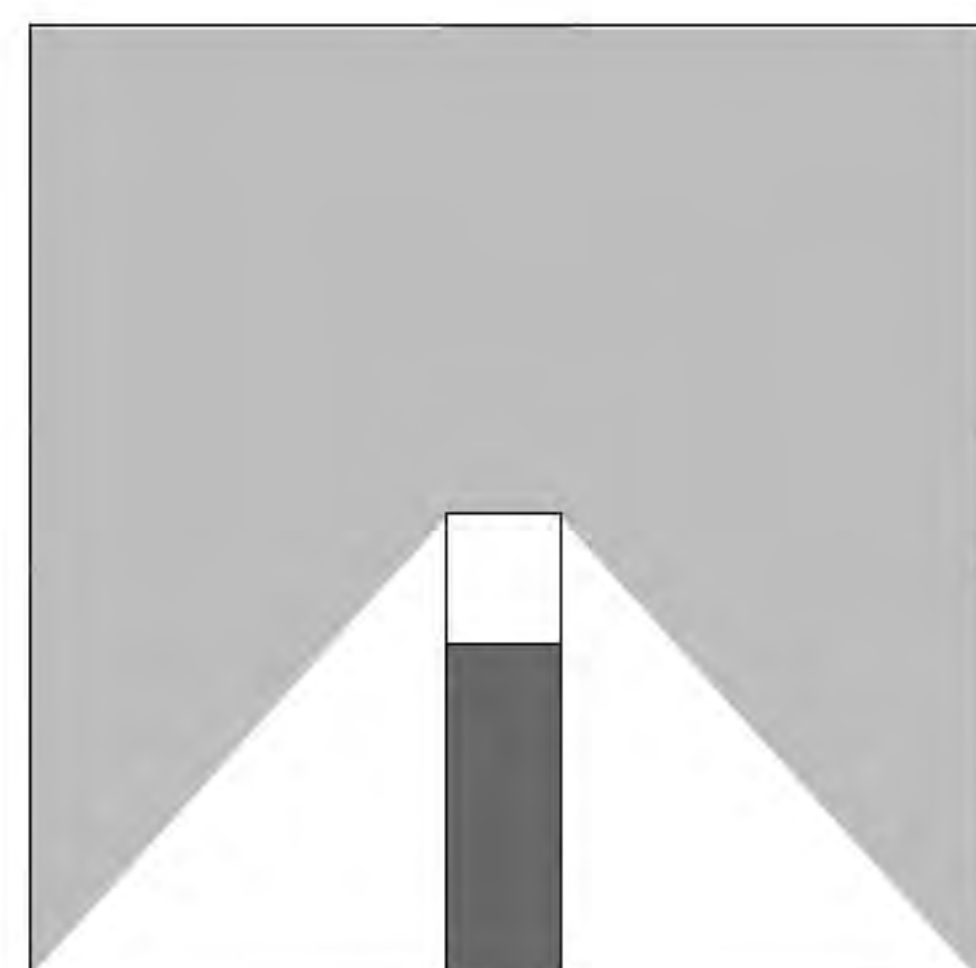

front view (正面图)



## Technical Date (技术参数)

Item No.	Lamp Type	Power	LM	CCT	PF	Voltage	CRI	A	B	C (mm)
MB23-022203	LED	5W	350	2700K-6000K	0.6	AC110-265V	80-90	Ø65	120	300
MB23-022206	LED	5W	350	2700K-6000K	0.6	AC110-265V	80-90	Ø65	120	600
MB23-022209	LED	5W	350	2700K-6000K	0.6	AC110-265V	80-90	Ø65	120	900
MB23-022303	LED	10W	700	2700K-6000K	0.6	AC110-265V	80-90	Ø90	120	300
MB23-022306	LED	10W	700	2700K-6000K	0.6	AC110-265V	80-90	Ø90	120	600
MB23-022309	LED	10W	700	2700K-6000K	0.6	AC110-265V	80-90	Ø90	120	900
MB23-022403	LED	12W	840	2700K-6000K	0.6	AC110-265V	80-90	Ø108	120	300
MB23-022406	LED	12W	840	2700K-6000K	0.6	AC110-265V	80-90	Ø108	120	600
MB23-022409	LED	12W	840	2700K-6000K	0.6	AC110-265V	80-90	Ø108	120	900



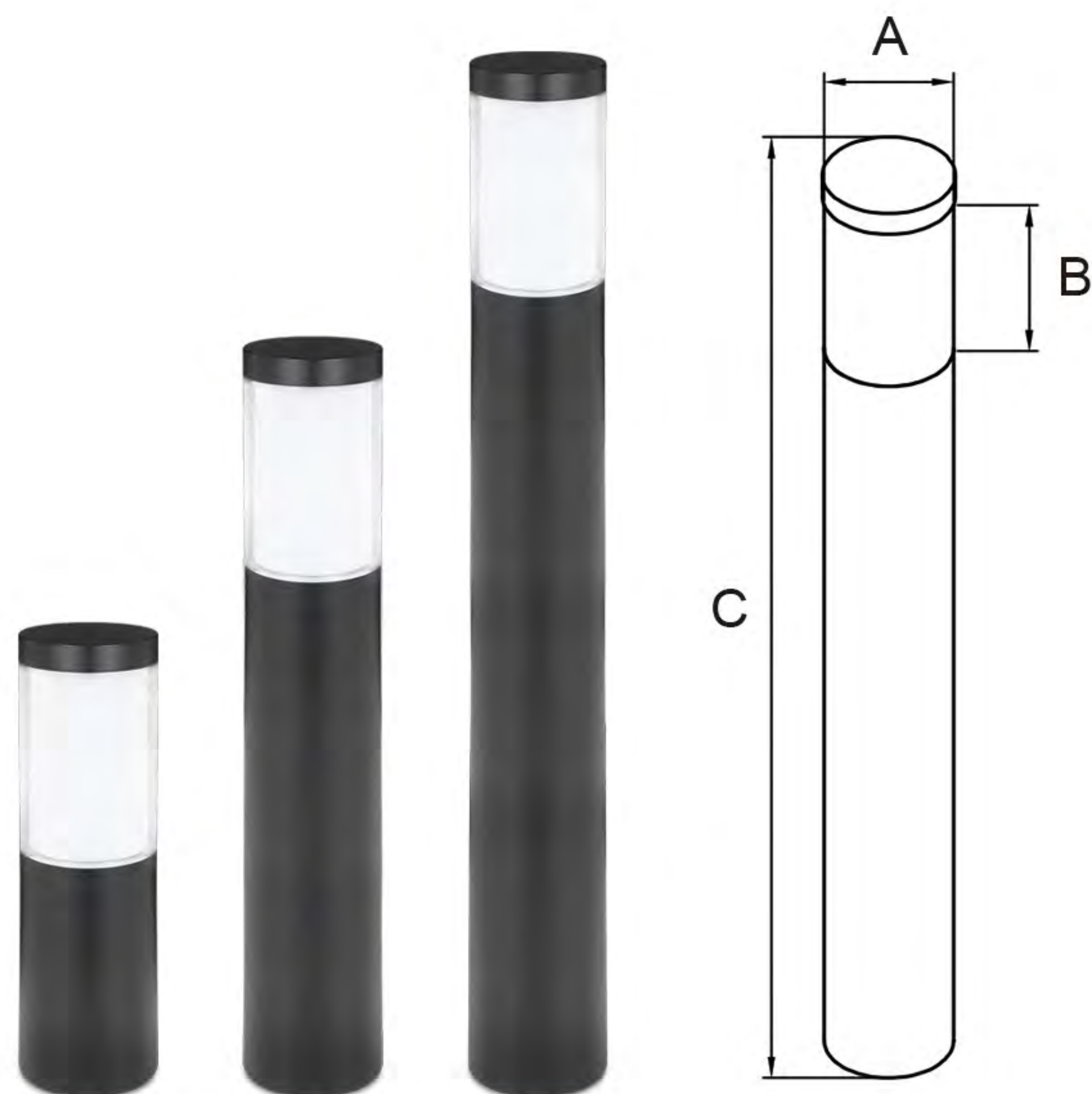

# MB23-0225

## Features&Benefit (功能和优点)

Category (品类)	Garden Light
Diffuser Material (扩散器材质)	PC
Cover Material (面盖材质)	Aluminum
Operating mode (运行)	Built in
Steuerbar (开关)	On/Off
IP (防水等级)	54
Mounting type (安装类型)	Put
Mounting location (安装位置)	Overground
Application environment (应用环境)	Indoor/Outdoor
Body color (表面颜色)	Black/Dark Gray/Sliver Gray



## Product Description (产品描述)

Suitable for parks and gardens, neighborhoods, villas, city squares, pedestrian streets, scenic spots or resorts and other various scenes; lawn lamps can be a variety of heights at the same time the lighting effect will be different, more to provide a choice.

## Lightmap (光影图)



top view (俯视图)

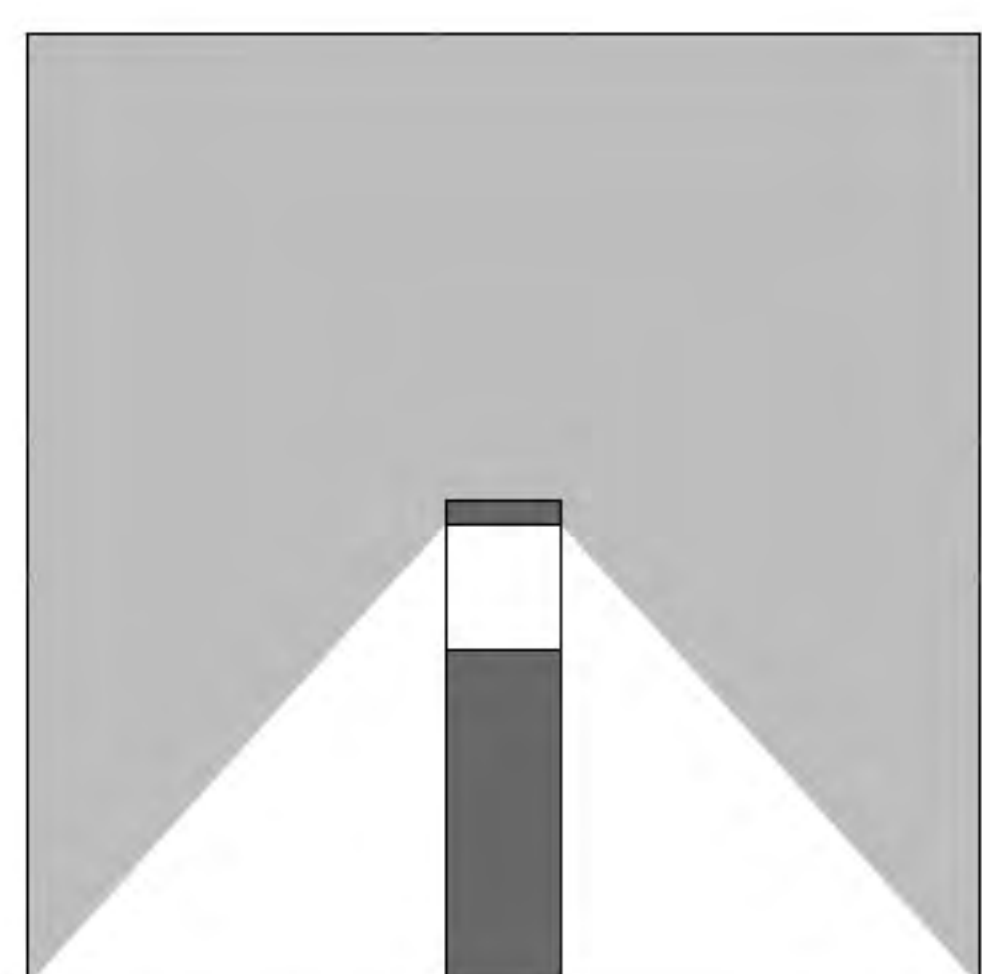

front view (正面图)



## Technical Date (技术参数)

Item No.	Lamp Type	Power	LM	CCT	PF	Voltage	CRI	A	B	C (mm)
MB23-022503	LED	5W	350	2700K-6000K	0.6	AC110-265V	80-90	Ø76	110	300
MB23-022506	LED	5W	350	2700K-6000K	0.6	AC110-265V	80-90	Ø76	110	600
MB23-022509	LED	5W	350	2700K-6000K	0.6	AC110-265V	80-90	Ø76	110	900



# MB23-0226

## Features&Benefit (功能和优点)

Category (品类)	Garden Light
Diffuser Material (扩散器材质)	PC
Cover Material (面盖材质)	Aluminum
Operating mode (运行)	Built in
Steuerbar (开关)	On/Off
IP (防水等级)	54
Mounting type (安装类型)	Insert
Mounting location (安装位置)	Underground
Application environment (应用环境)	Indoor/Outdoor
Body color (表面颜色)	Black/Dark Gray/Sliver Gray



## Product Description (产品描述)

Suitable for urban slow lane, narrow lanes, residential neighborhoods, tourist attractions, parks, squares, private gardens, courtyard corridors and other public places of the road on one side or both sides of the road lighting; unique design, soft light, so that the scene is full of layers.

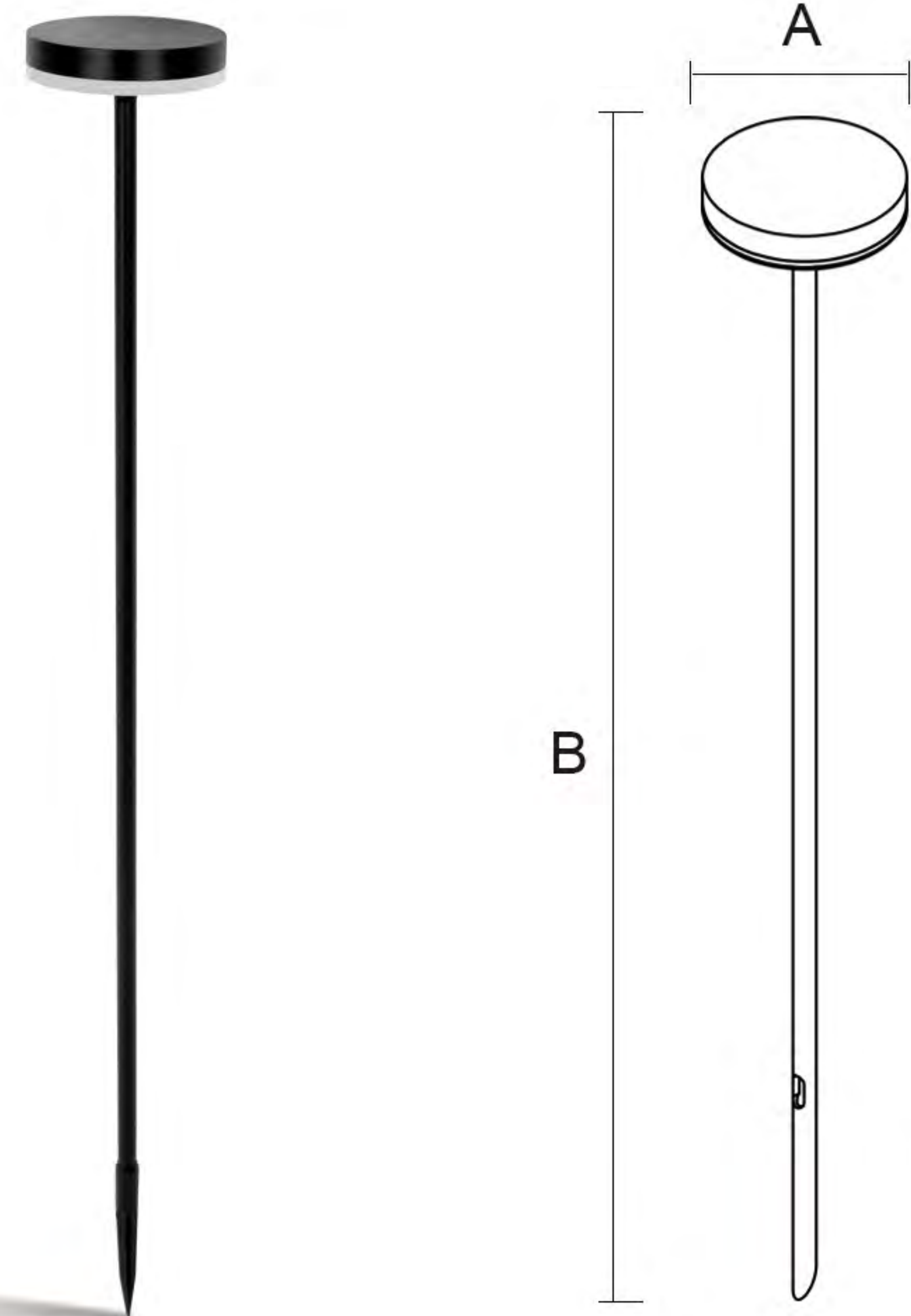

## Lightmap (光影图)



top view (俯视图)

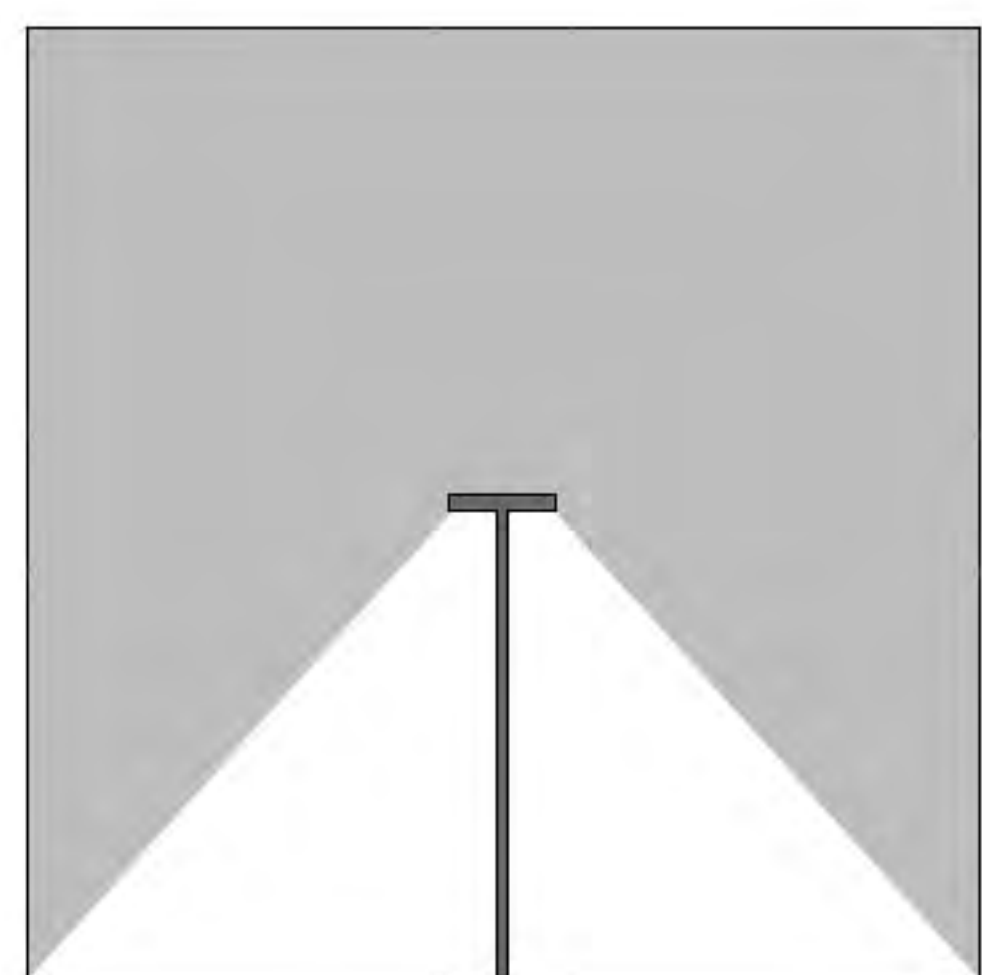

front view (正面图)



## Technical Date (技术参数)

Item No.	Lamp Type	Power	LM	CCT	PF	Voltage	CRI	A	B	C (mm)
MB23-0226	LED	9W	630	2700K-6000K	0.6	DC24V	80-90	Ø105	810	-



# MB23-0230

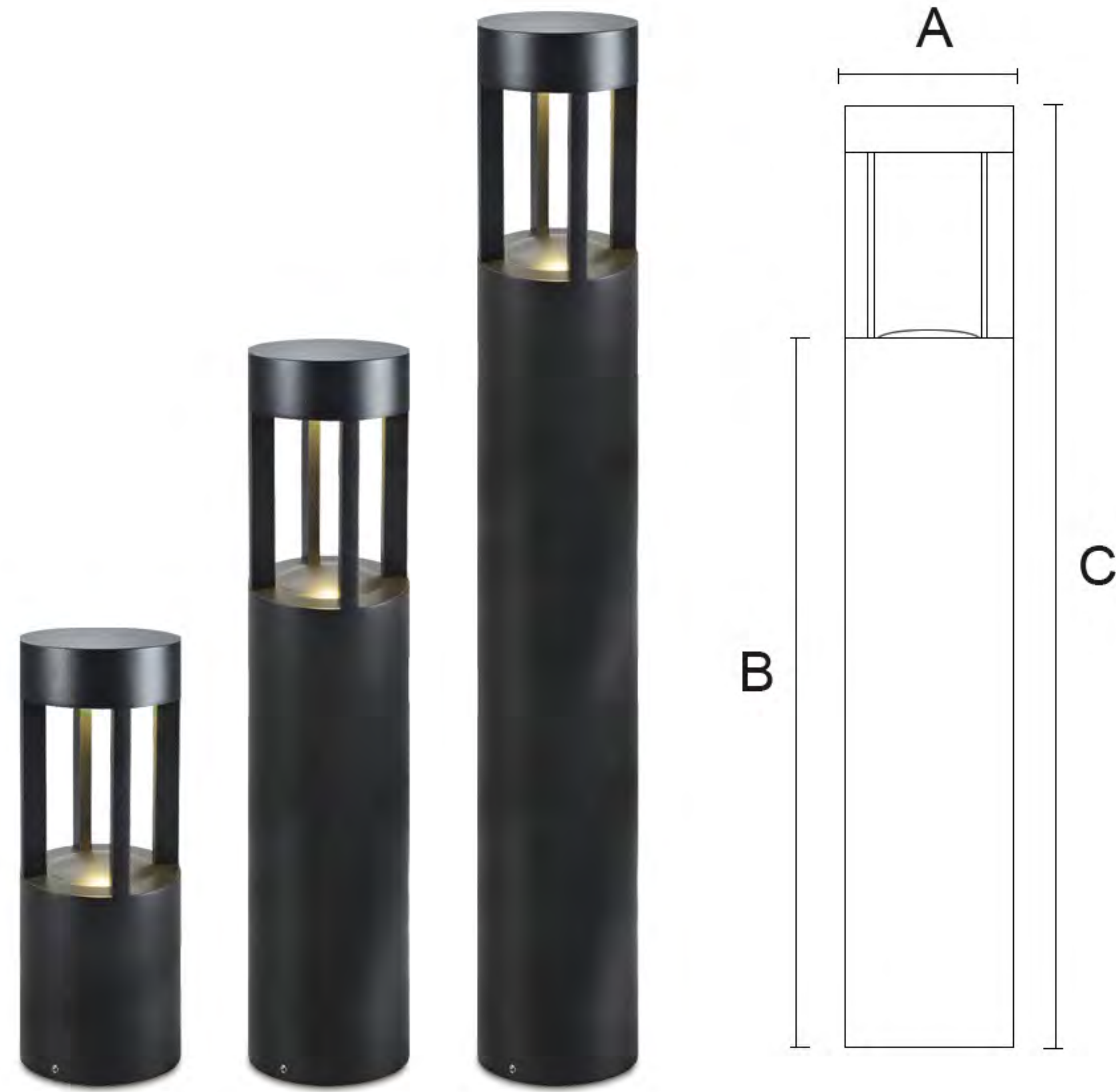

## Features&Benefit (功能和优点)

Category (品类)	Garden Light
Diffuser Material (扩散器材质)	Glass
Cover Material (面盖材质)	Aluminum
Operating mode (运行)	Built in
Steuerbar (开关)	On/Off
IP (防水等级)	54
Mounting type (安装类型)	Put
Mounting location (安装位置)	Overground
Application environment (应用环境)	Indoor/Outdoor
Body color (表面颜色)	Black/Dark Gray/Sliver Gray



## Product Description (产品描述)

Suitable for parks and gardens, neighborhoods, villas, city squares, pedestrian streets, scenic spots or resorts and other various scenes; lawn lamps can be a variety of heights at the same time the lighting effect will be different, more to provide a choice.

## Lightmap (光影图)

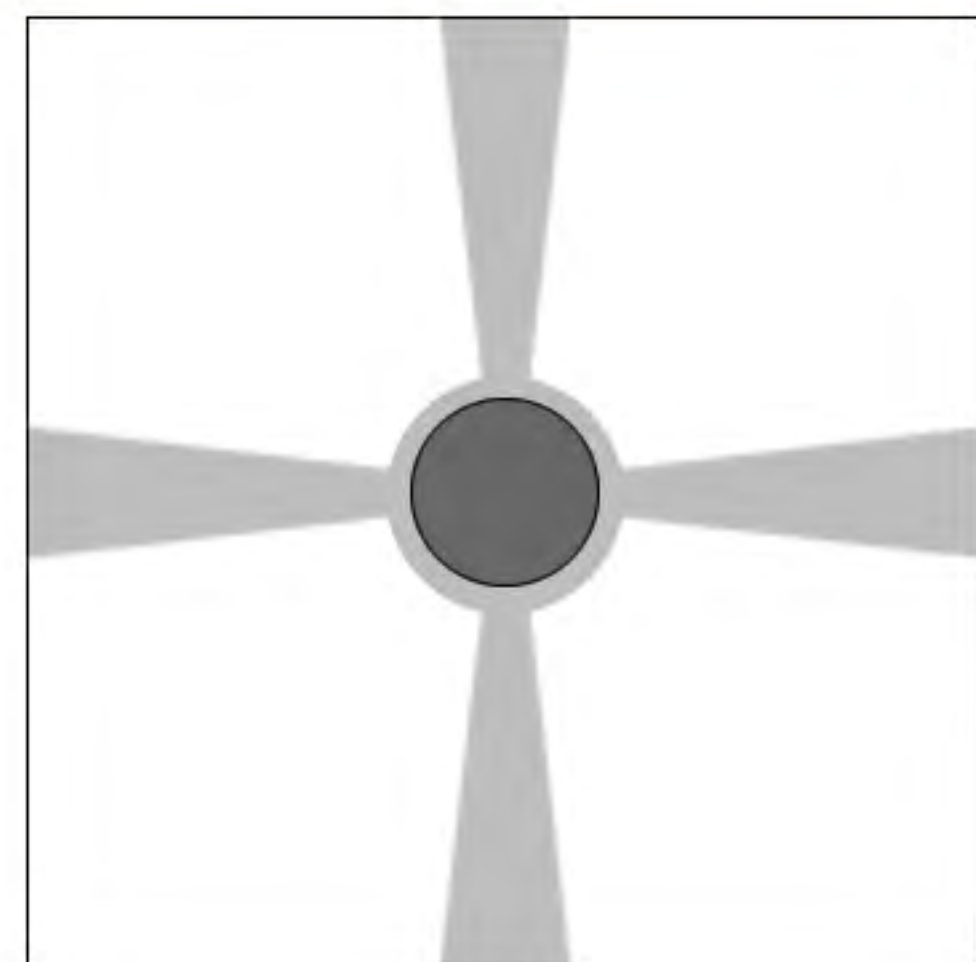

top view (俯视图)

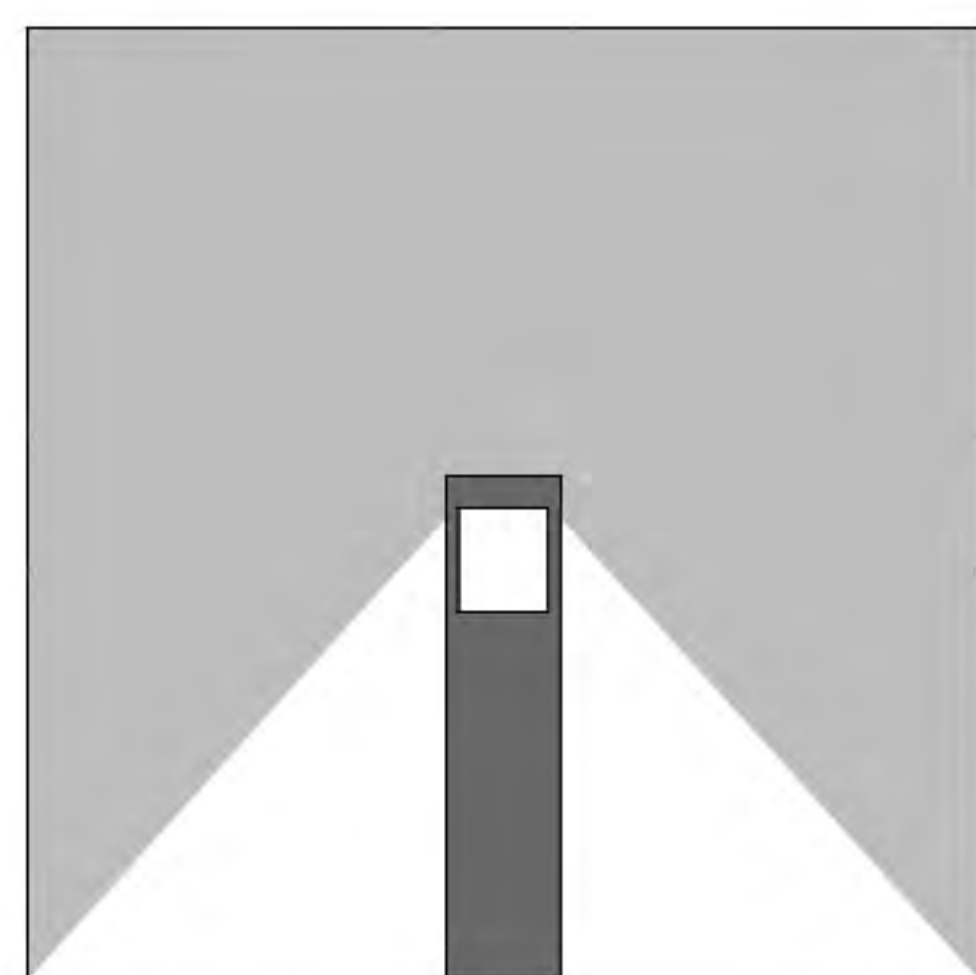

front view (正面图)



## Technical Date (技术参数)

Item No.	Lamp Type	Power	LM	CCT	PF	Voltage	CRI	A	B	C (mm)
MB23-023003	LED	10W	700	2700K-6000K	0.6	AC110-265V	80-90	Ø90	150	300
MB23-023006	LED	10W	700	2700K-6000K	0.6	AC110-265V	80-90	Ø90	430	600
MB23-023009	LED	10W	700	2700K-6000K	0.6	AC110-265V	80-90	Ø90	750	900



# MB24-0201/MB24-0202

## Features&Benefit (功能和优点)

Category (品类)	Garden Light
Diffuser Material (扩散器材质)	Glass
Cover Material (面盖材质)	Aluminum
Operating mode (运行)	Built in
Steuerbar (开关)	On/Off
IP (防水等级)	54
Mounting type (安装类型)	Put
Mounting location (安装位置)	Overground
Application environment (应用环境)	Indoor/Outdoor
Body color (表面颜色)	Black/Dark Gray/Sliver Gray



## Product Description (产品描述)

Suitable for urban slow lane, narrow lanes, residential neighborhoods, tourist attractions, parks, squares, private gardens, courtyard corridors and other public places of the road on one side or both sides of the road lighting; unique design, soft light, so that the scene is full of layers.

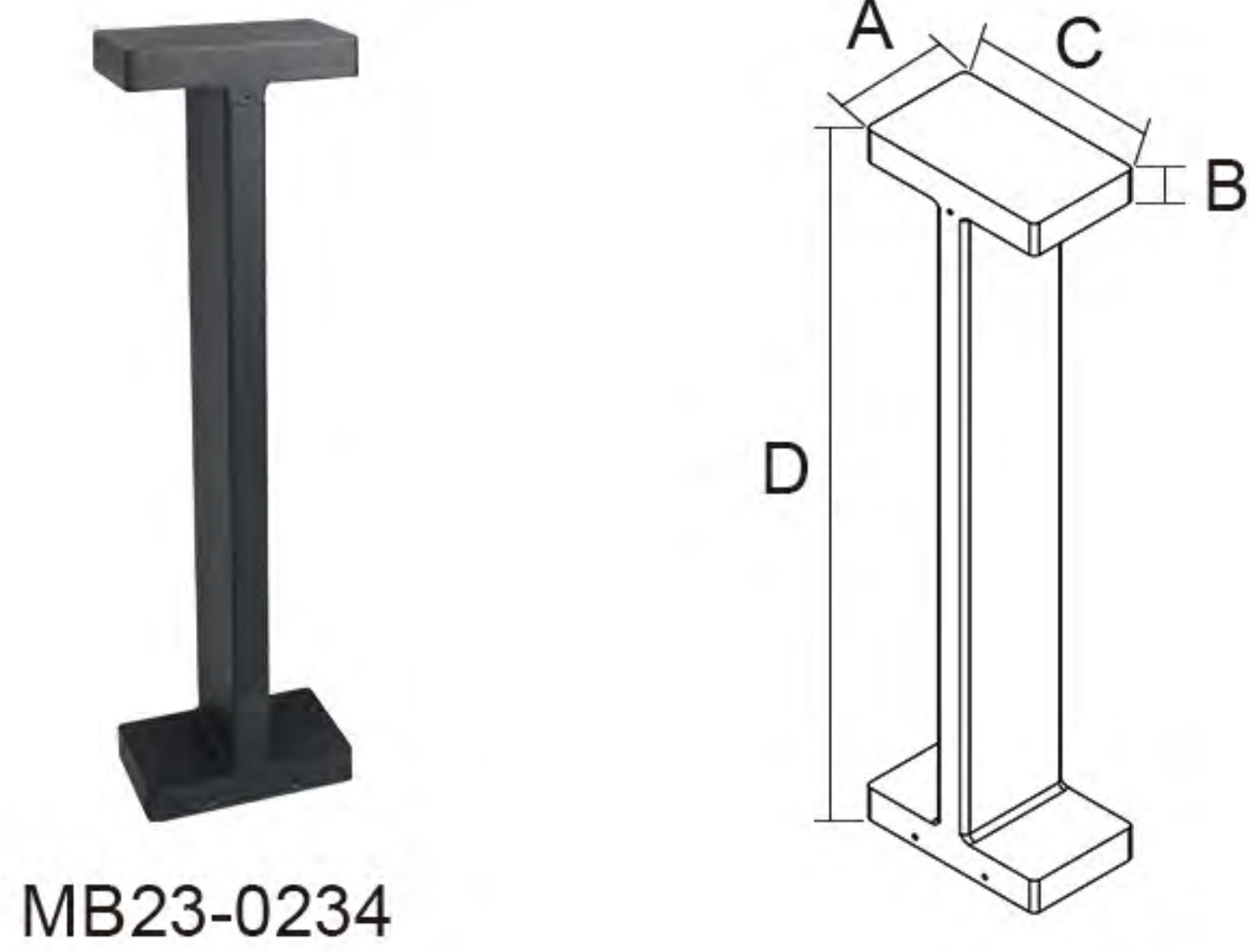
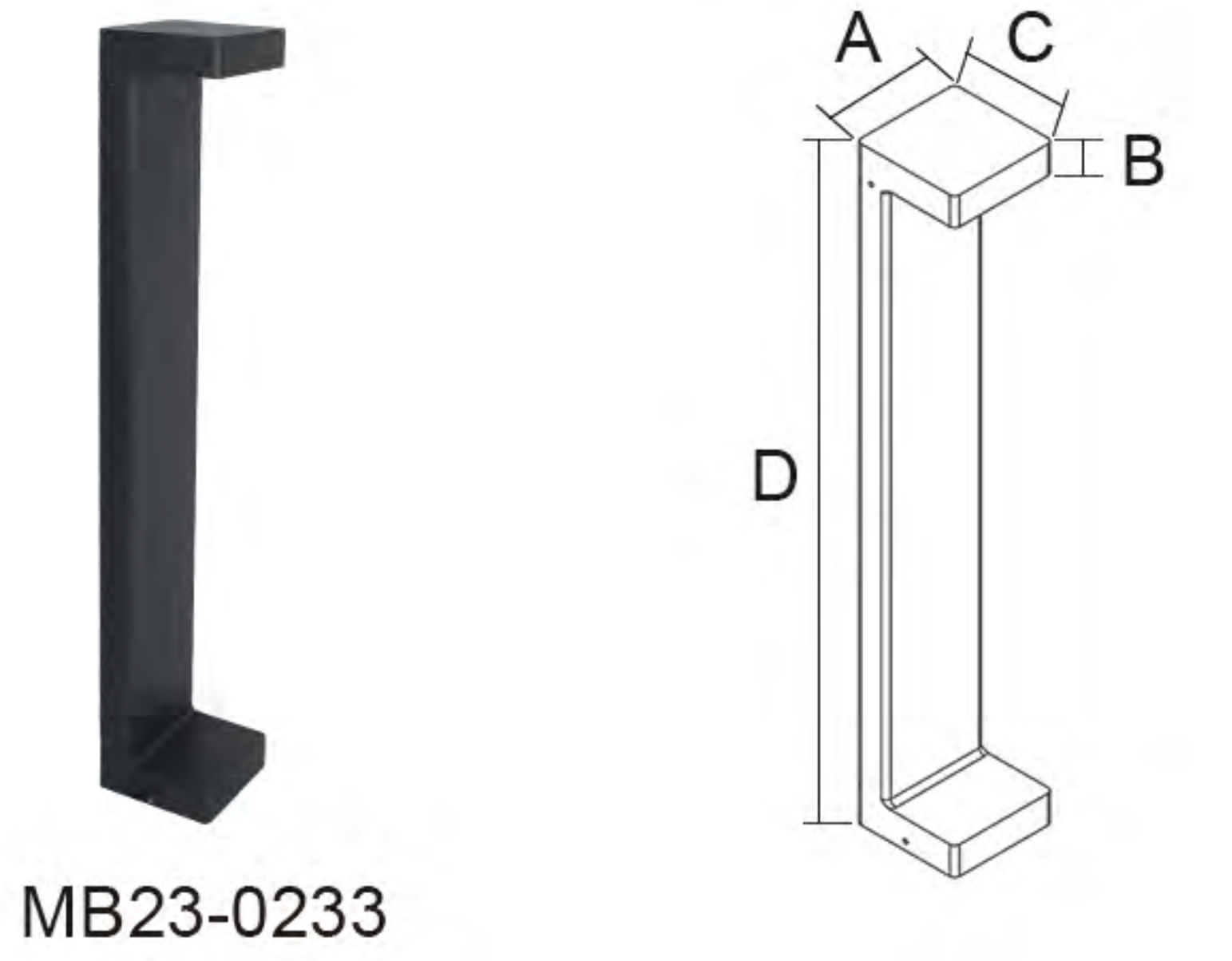

## Lightmap (光影图)

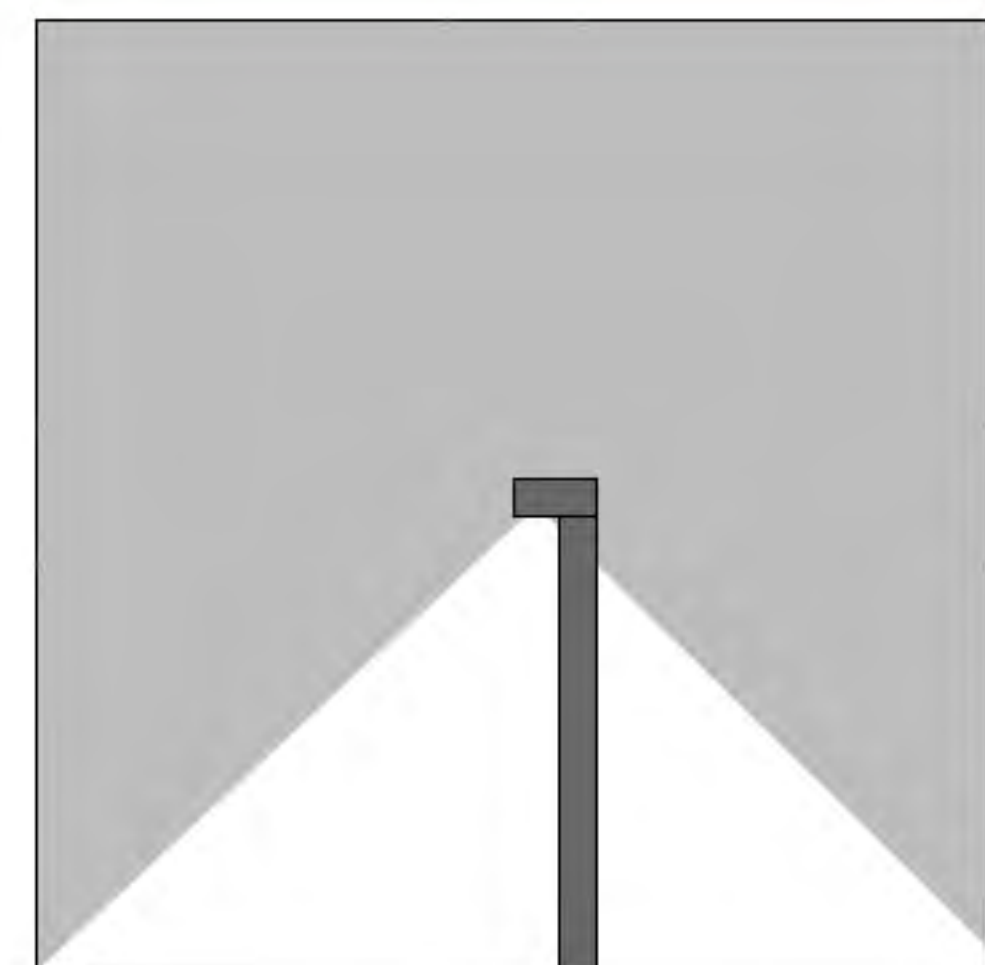

front view (正面图)

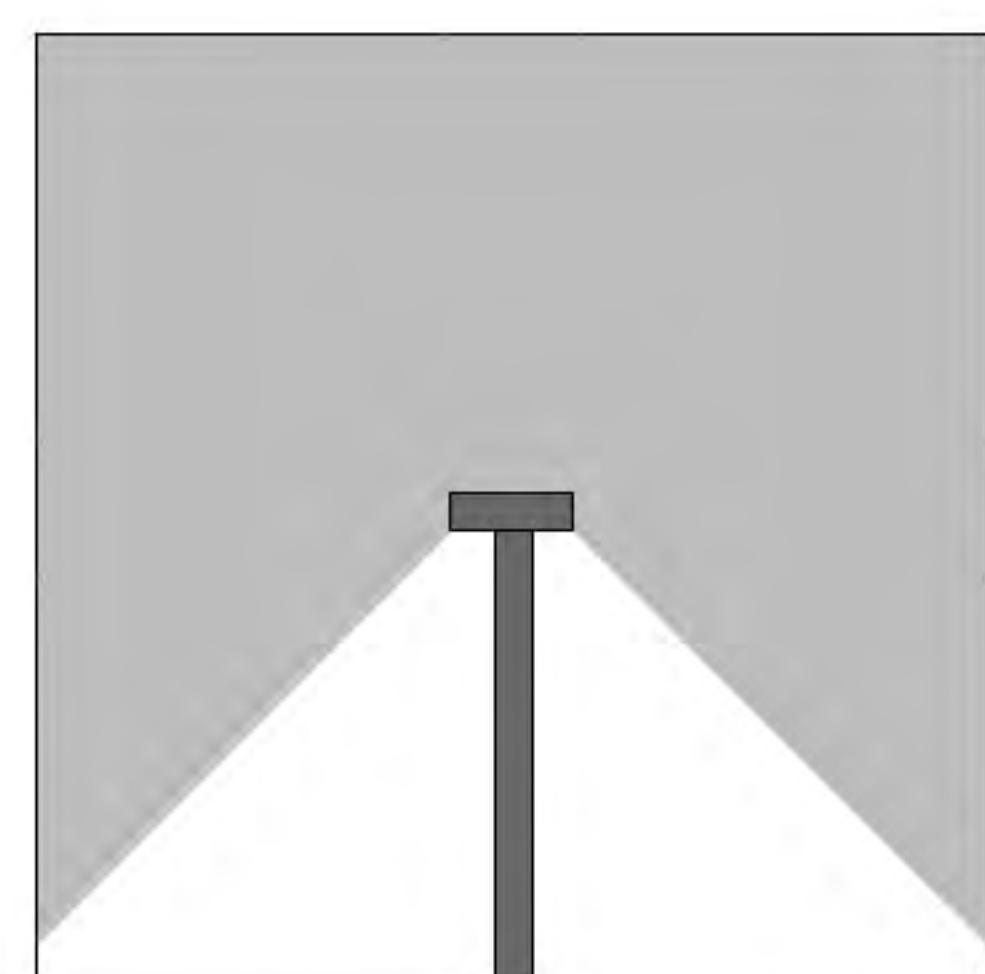

front view (正面图)

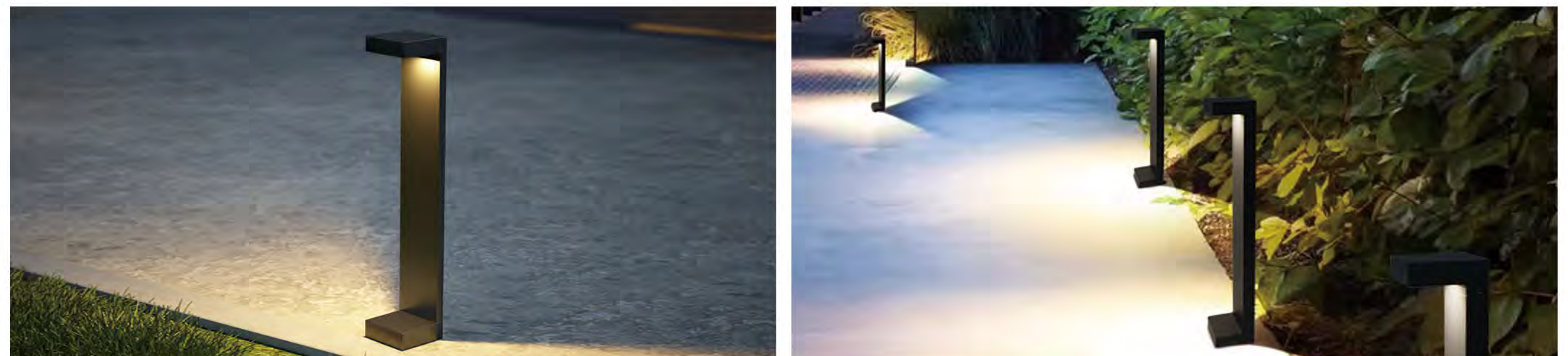

## Technical Date (技术参数)

Item No.	Lamp Type	Power	LM	CCT	PF	Voltage	CRI	A	B	C	D(mm)
MB24-0201	LED	10W	700	2700K-6000K	0.6	AC110-265V	80-90	100	28	100	600
MB24-0202	LED	2*10W	1400	2700K-6000K	0.6	AC110-265V	80-90	100	28	170	600



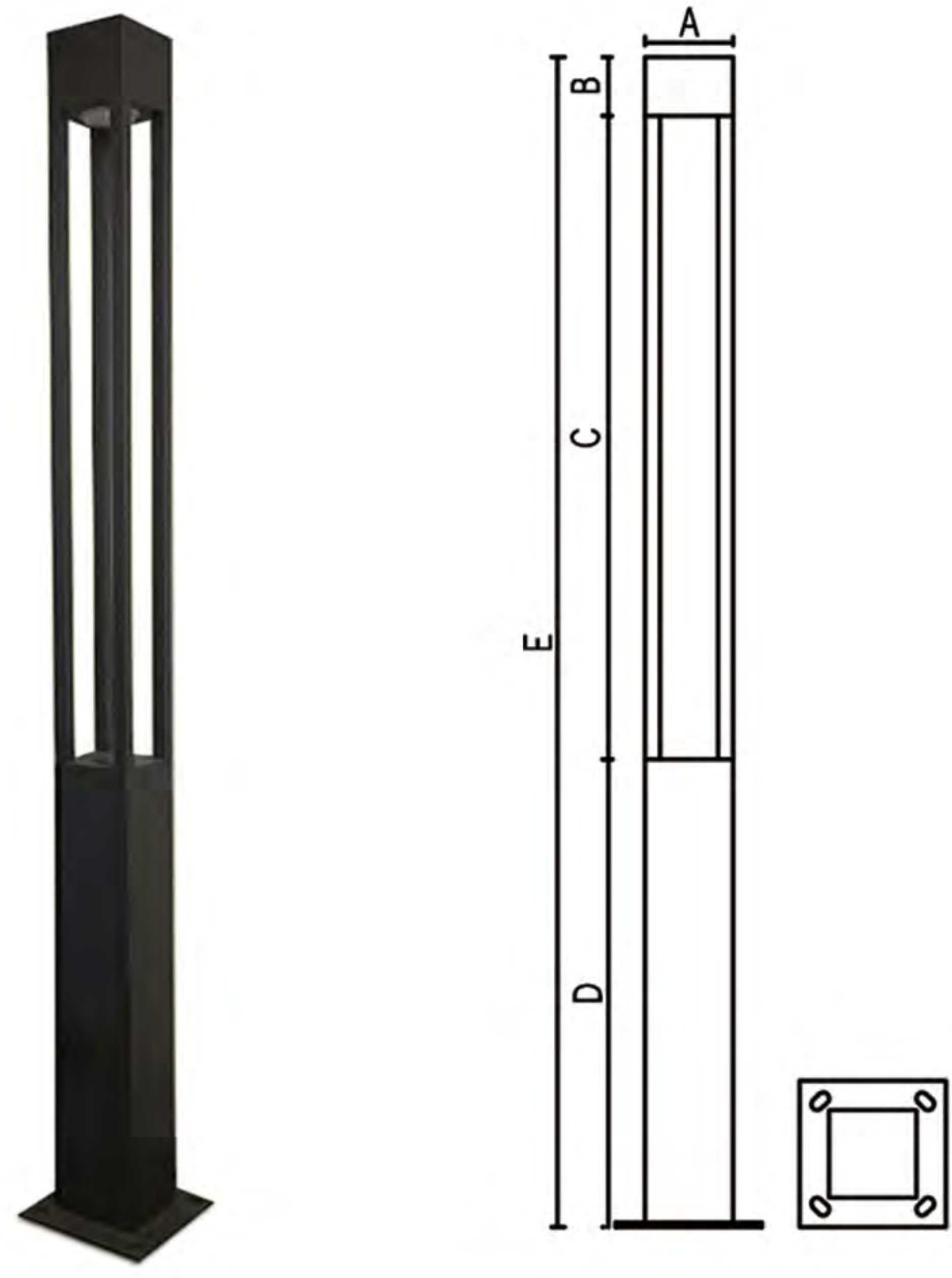

# MB-T001

## Features&Benefit (功能和优点)

Category (品类)	Garden Light
Diffuser Material (扩散器材质)	Acrylic
Cover Material (面盖材质)	Aluminum
Operating mode (运行)	Built in
Steuerbar (开关)	On/Off
IP (防水等级)	54
Mounting type (安装类型)	Put
Mounting location (安装位置)	Overground
Application environment (应用环境)	Indoor/Outdoor
Body color (表面颜色)	Black/Dark Gray/Sliver Gray



## Product Description (产品描述)

They are suitable for outdoor lighting in city lanes, narrow lanes, residential neighborhoods, tourist attractions, parks, squares, private gardens courtyards corridors and other public places; the heights can be selected in many ways, which can satisfy different scenarios and desired effects. They create a pleasant atmosphere, add a sense of decoration to the scene and enhance its overall appearance.

## Lightmap (光影图)

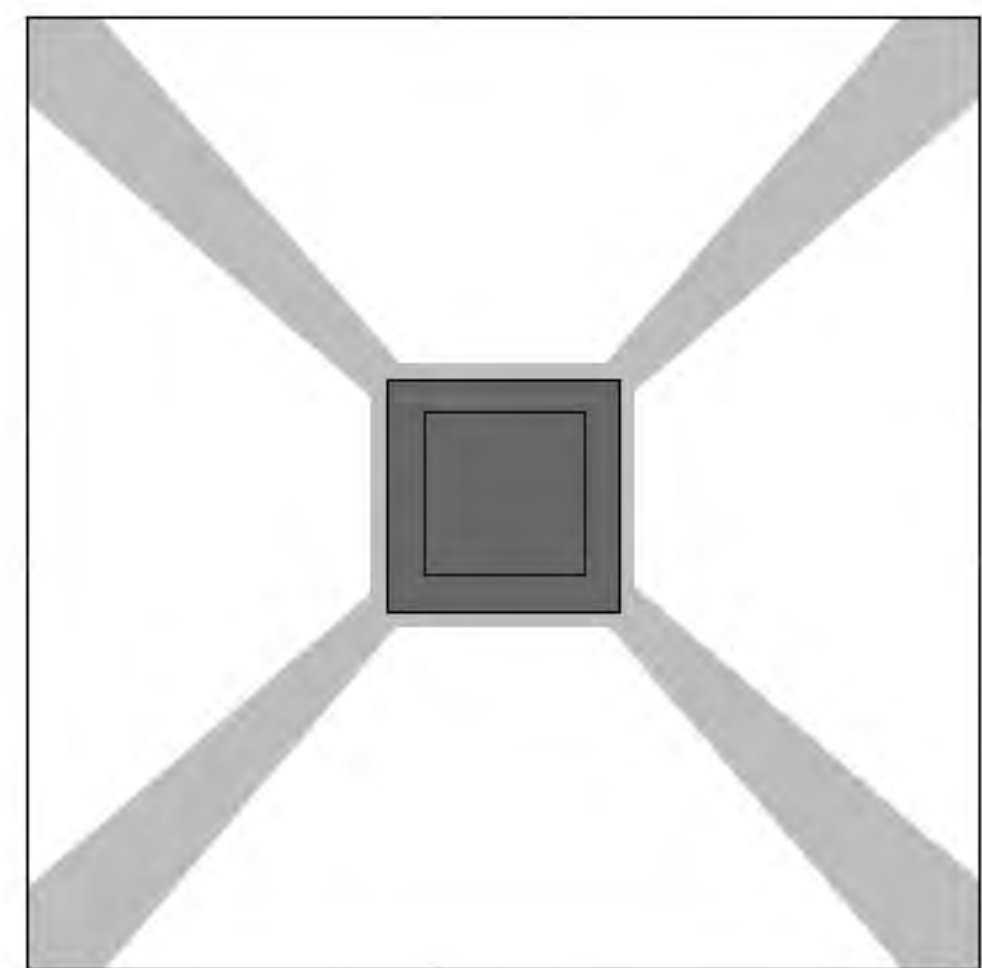

top view (俯视图)

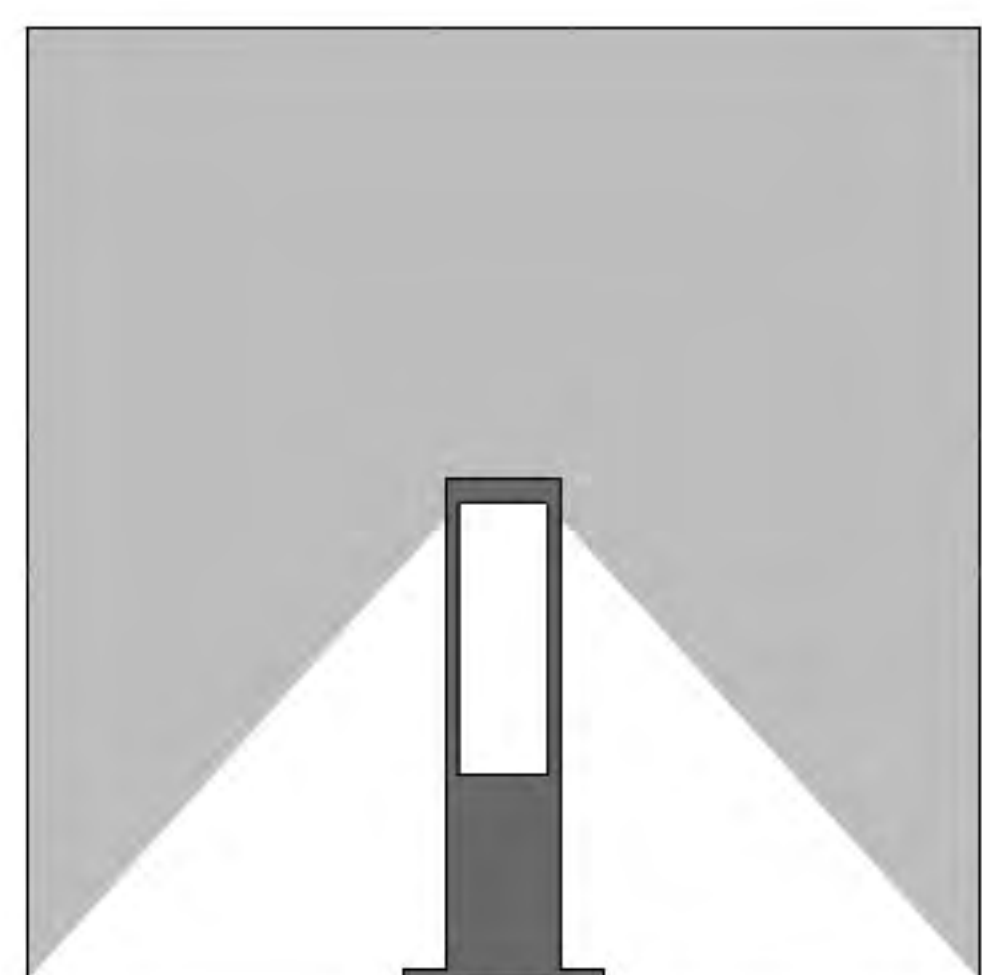

front view (正面图)



## Technical Date (技术参数)

Item No.	Lamp Type	Power	LM	CCT	PF	Voltage	CRI	A	B	C	D	E (mm)
MB-T001/150	LED	30W	2100	2700-6000K	0.9	AC110-265V	80-90	150	150	1350	1000	2500
MB-T001/200	LED	40W	2800	2700-6000K	0.9	AC110-265V	80-90	200	200	1800	1500	3500
MB-T001/250	LED	50W	3500	2700-6000K	0.9	AC110-265V	80-90	250	250	1950	1800	4000



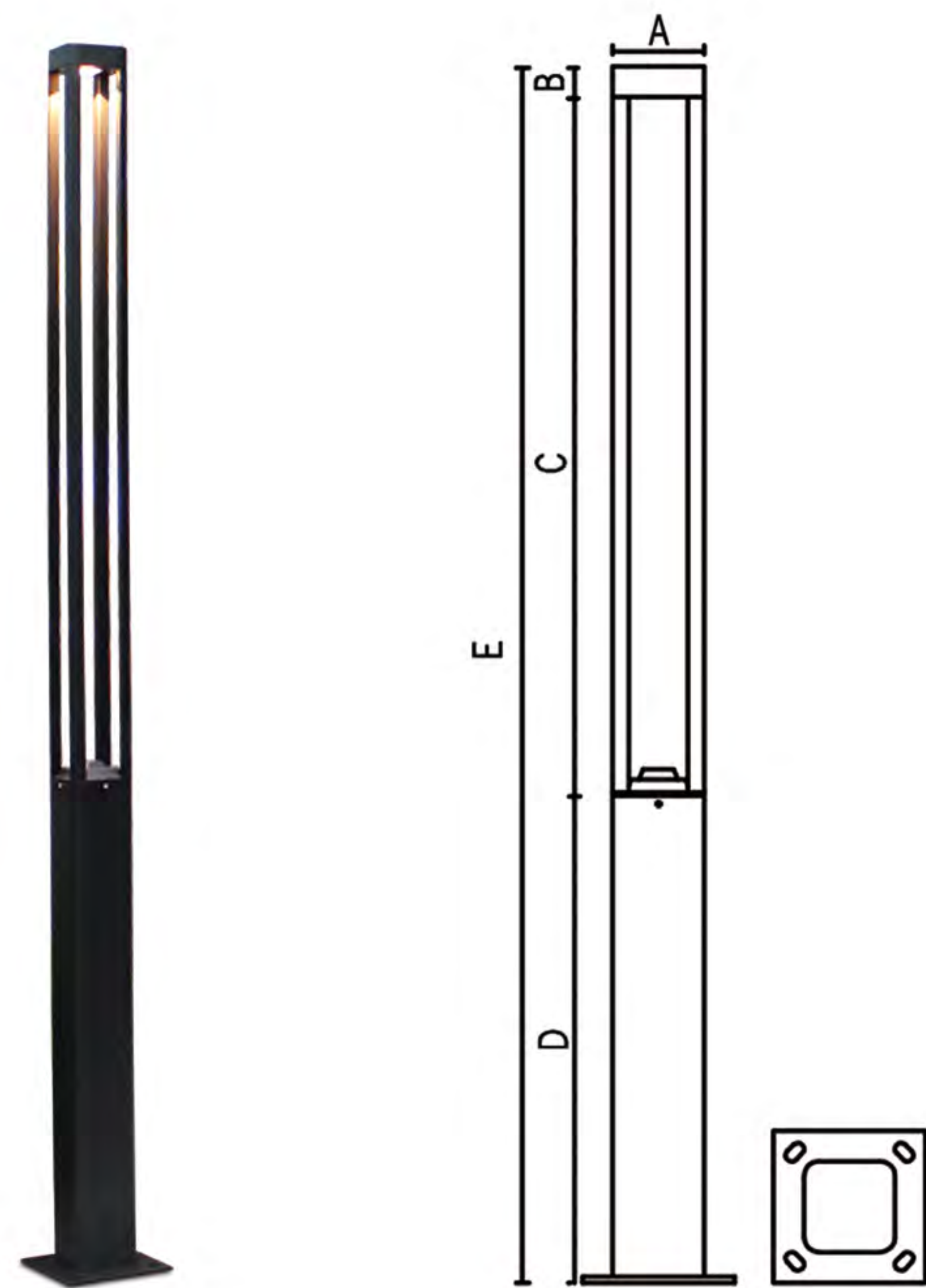

# MB-T002

## Features&Benefit (功能和优点)

Category (品类)	Garden Light
Diffuser Material (扩散器材质)	Glass
Cover Material (面盖材质)	Aluminum
Operating mode (运行)	Built in
Steuerbar (开关)	On/Off
IP (防水等级)	54
Mounting type (安装类型)	Put
Mounting location (安装位置)	Overground
Application environment (应用环境)	Indoor/Outdoor
Body color (表面颜色)	Black/Dark Gray/Sliver Gray



## Product Description (产品描述)

They are suitable for outdoor lighting in city lanes, narrow lanes, residential neighborhoods, tourist attractions, parks, squares, private gardens courtyards corridors and other public places; the heights can be selected in many ways, which can satisfy different scenarios and desired effects. They create a pleasant atmosphere, add a sense of decoration to the scene and enhance its overall appearance.

## Lightmap (光影图)

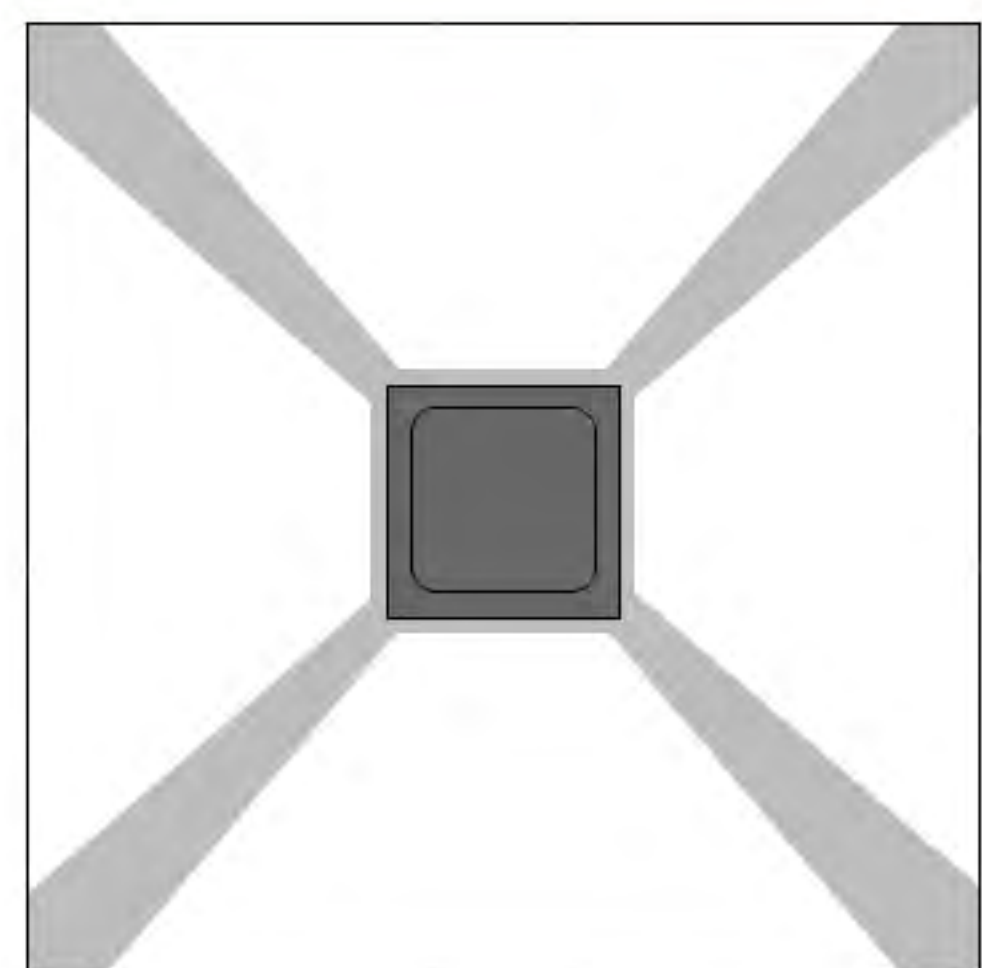

top view (俯视图)

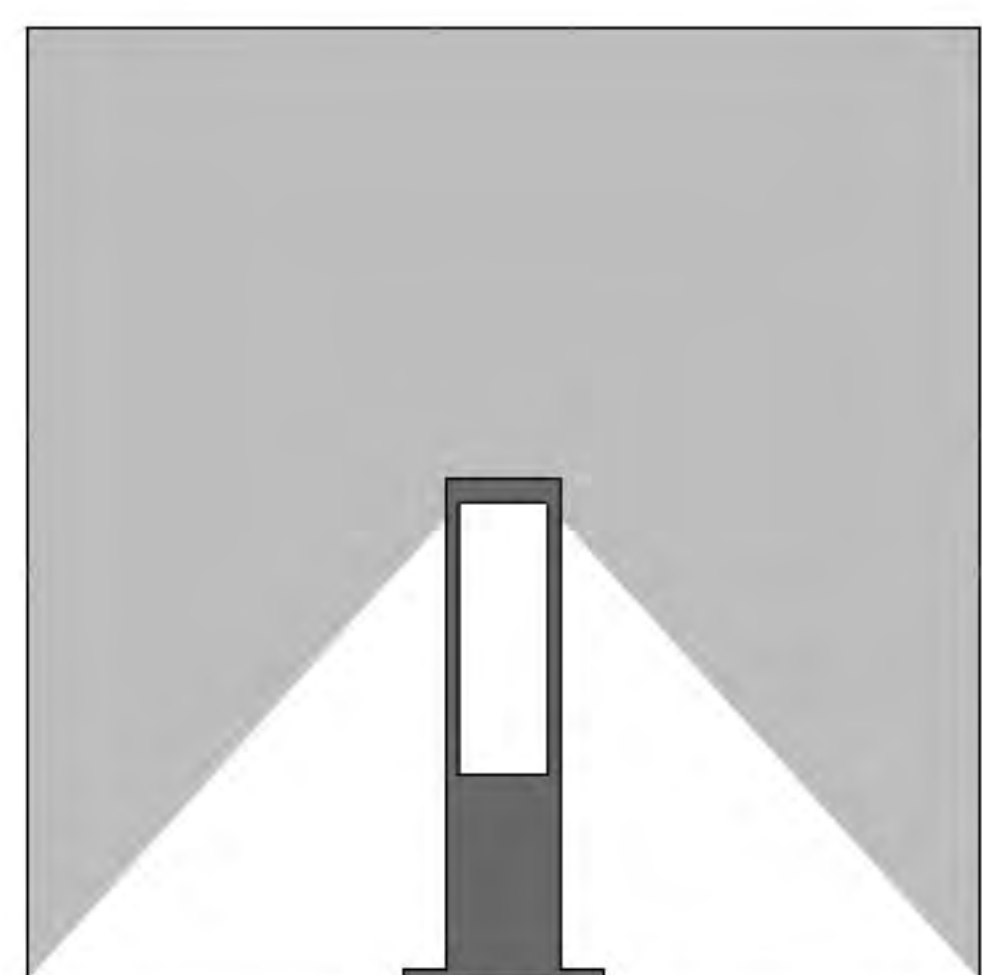

front view (正面图)

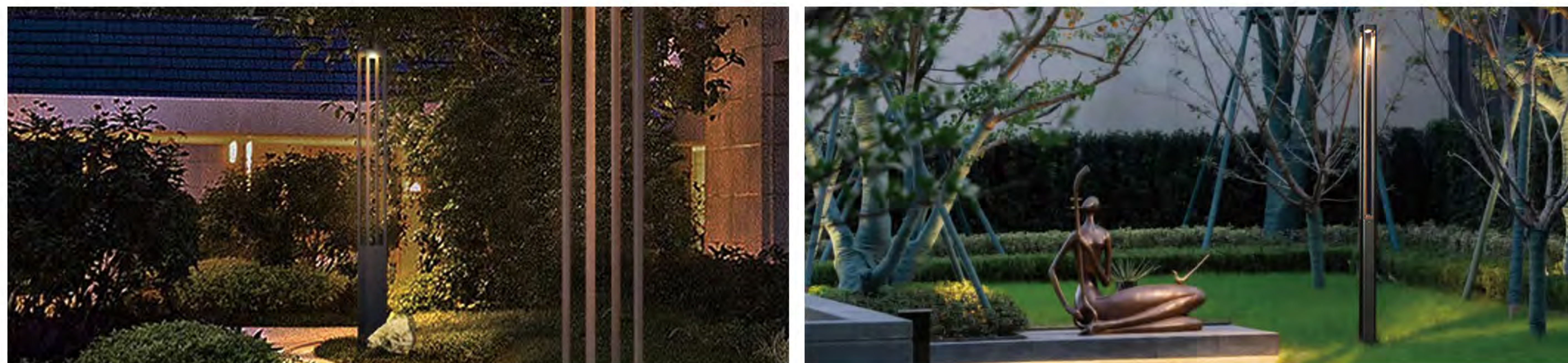

## Technical Date (技术参数)

Item No.	Lamp Type	Power	LM	CCT	PF	Voltage	CRI	A	B	C	D	E (mm)
MB-T002	LED	20W	1400	2700-6000K	0.9	AC110-265V	80-90	120	45	1455	1000	2500





# MB-T005

## Features&Benefit (功能和优点)

Category (品类)	Garden Light
Diffuser Material (扩散器材质)	Glass
Cover Material (面盖材质)	Aluminum
Operating mode (运行)	Built in
Steuerbar (开关)	On/Off
IP (防水等级)	54
Mounting type (安装类型)	Put
Mounting location (安装位置)	Overground
Application environment (应用环境)	Indoor/Outdoor
Body color (表面颜色)	Black/Dark Gray/Sliver Gray



## Product Description (产品描述)

They are suitable for outdoor lighting in city lanes, narrow lanes, residential neighborhoods, tourist attractions, parks, squares, private gardens courtyards corridors and other public places; the heights can be selected in many ways, which can satisfy different scenarios and desired effects. They create a pleasant atmosphere, add a sense of decoration to the scene and enhance its overall appearance.

## Lightmap (光影图)

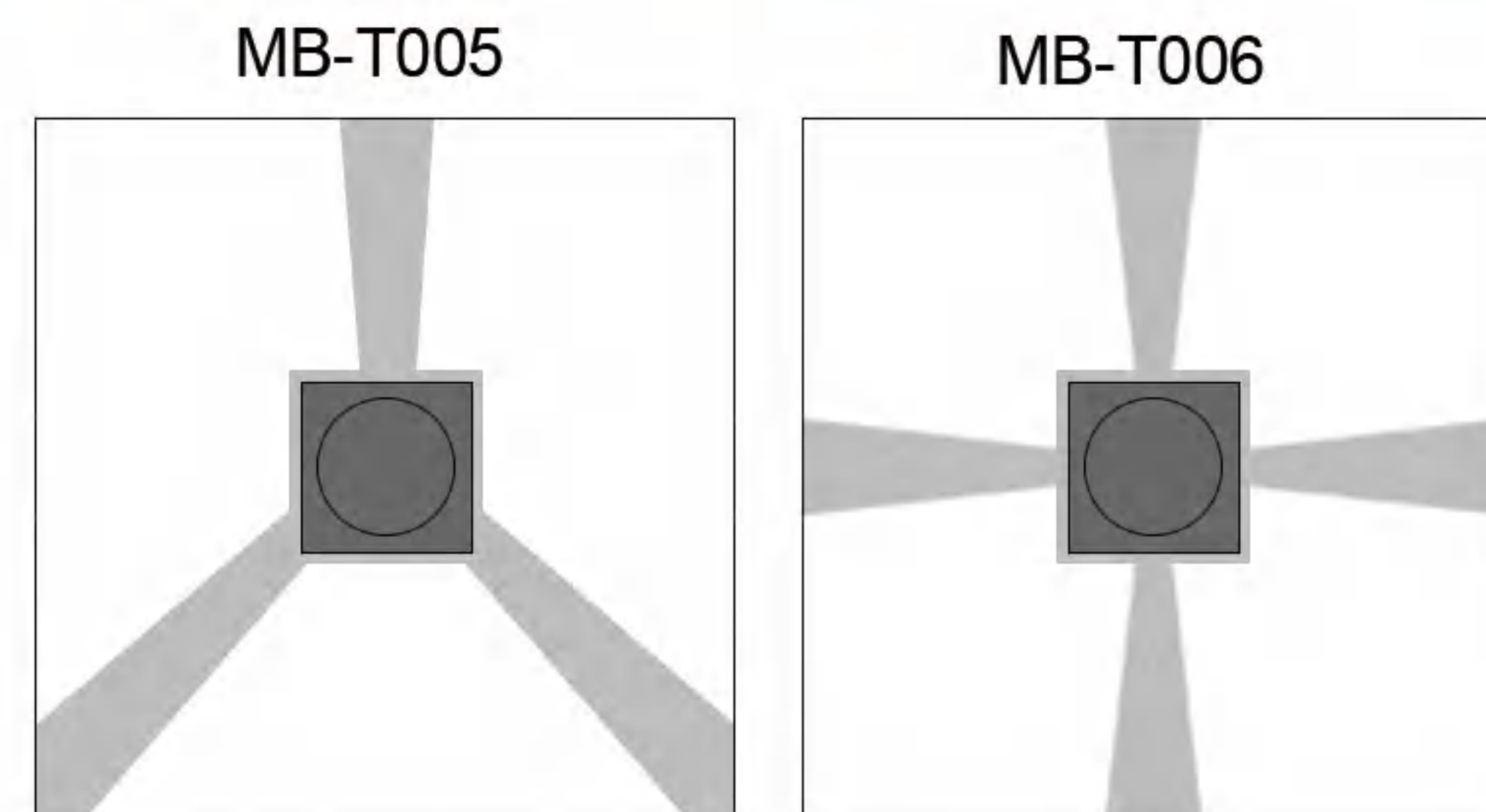

top view (俯视图)

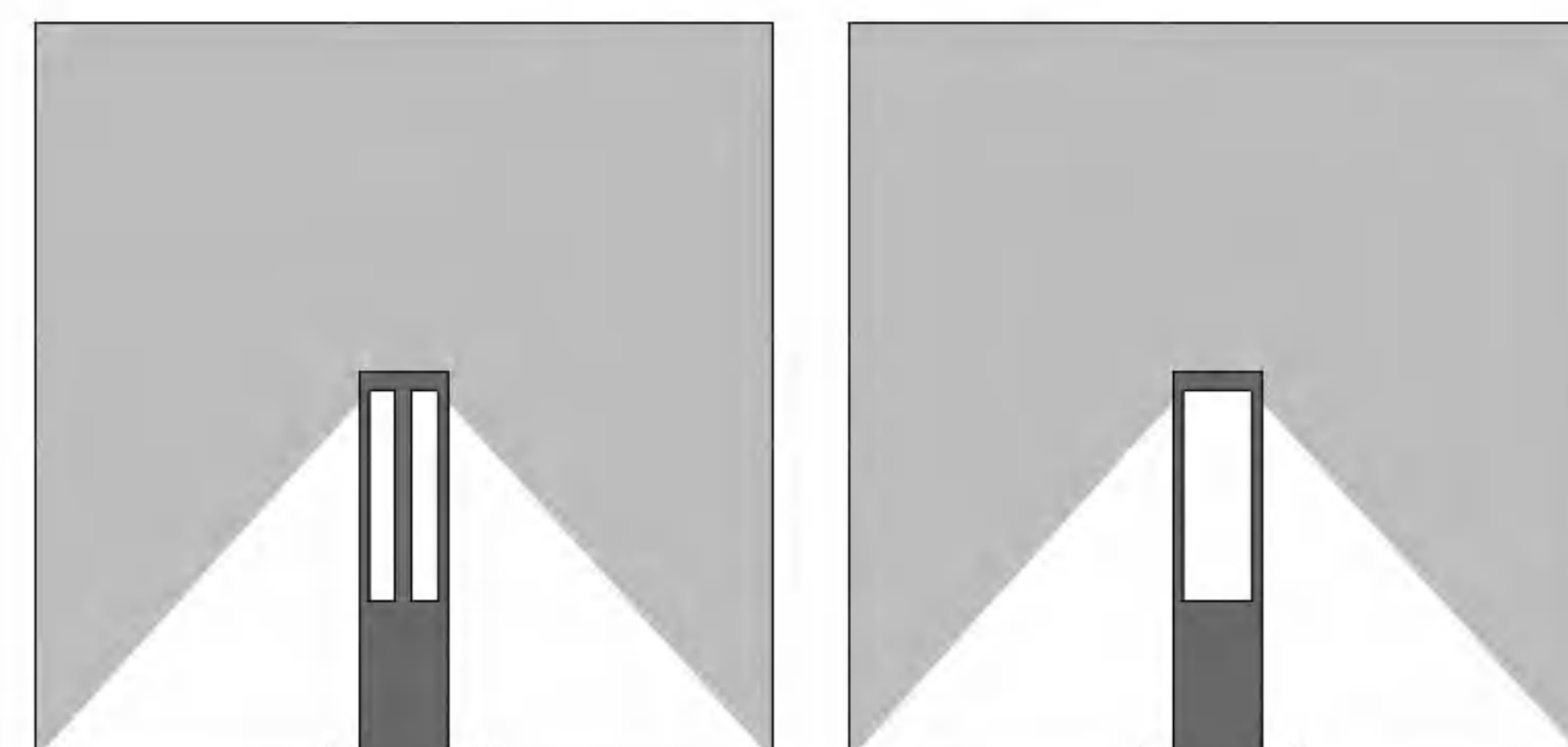

front view (正面图)

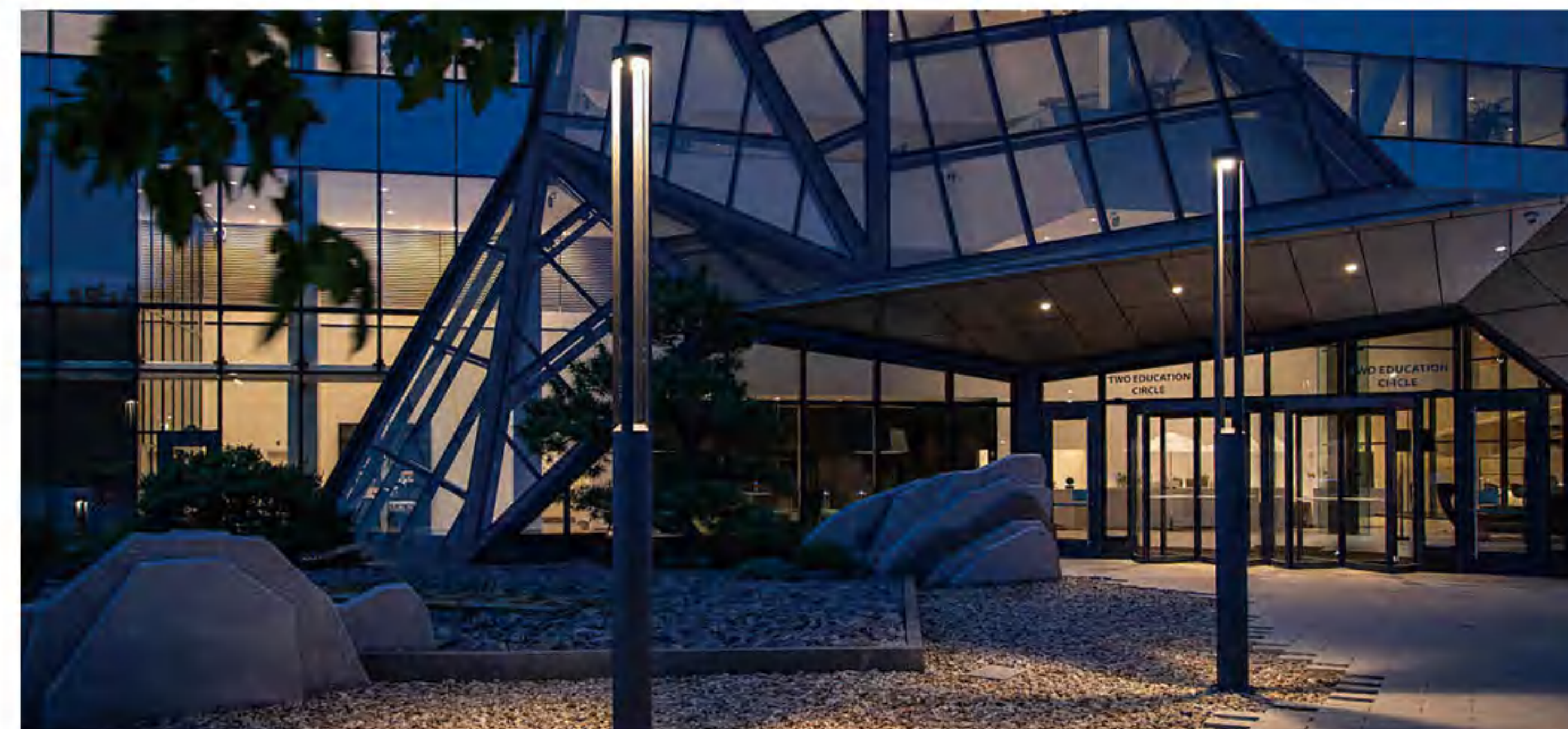

## Technical Date (技术参数)

Item No.	Lamp Type	Power	LM	CCT	PF	Voltage	CRI	A	B	C	D	E (mm)
MB-T005	LED	20W	1400	2700-6000K	0.9	AC110-265V	80-90	Ø150	50	1450	1000	2500
MB-T006	LED	20W	1400	2700-6000K	0.9	AC110-265V	80-90	Ø150	50	1450	1000	2500



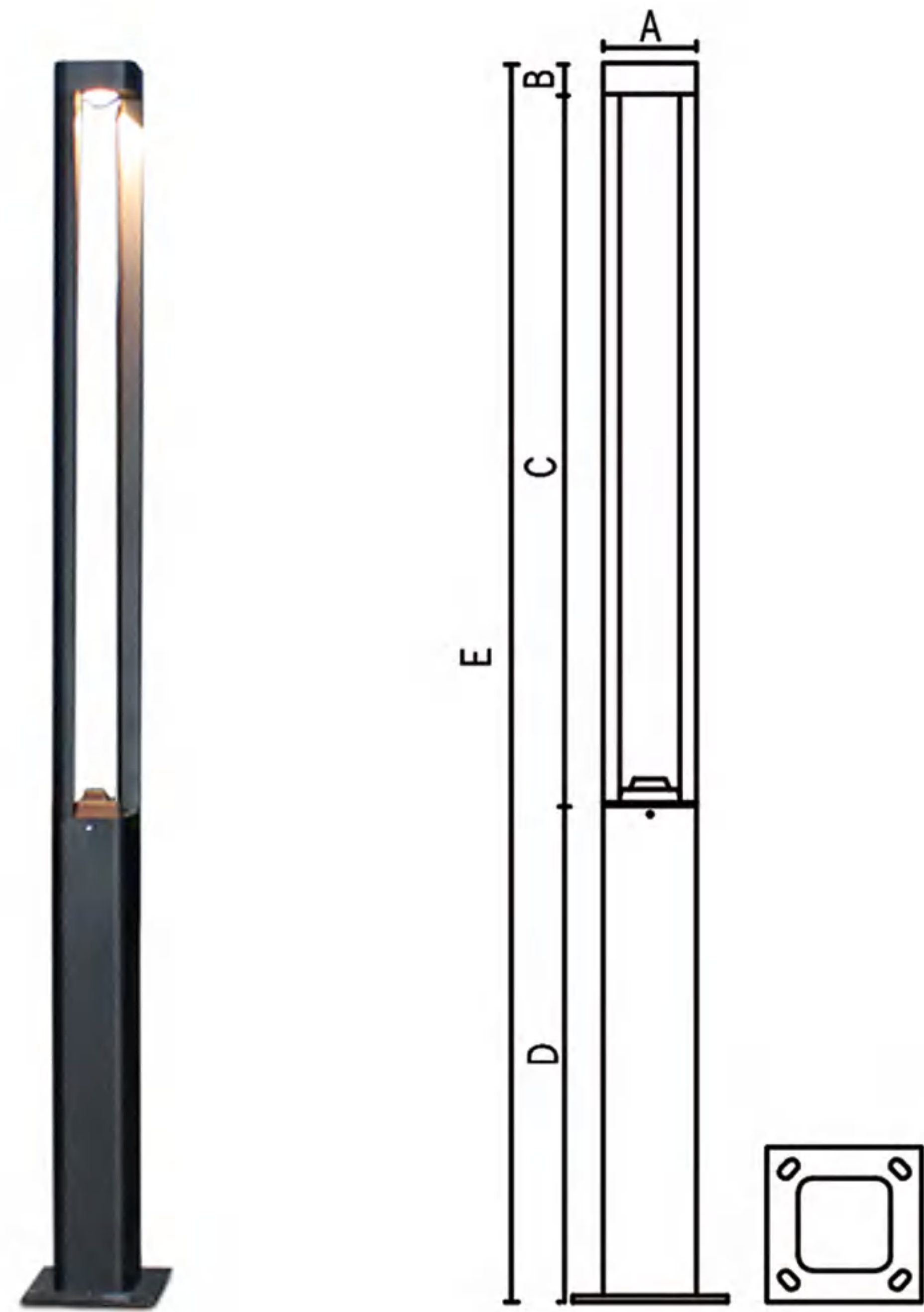

# MB-T007

## Features&Benefit (功能和优点)

Category (品类)	Garden Light
Diffuser Material (扩散器材质)	Glass
Cover Material (面盖材质)	Aluminum
Operating mode (运行)	Built in
Steuerbar (开关)	On/Off
IP (防水等级)	54
Mounting type (安装类型)	Put
Mounting location (安装位置)	Overground
Application environment (应用环境)	Indoor/Outdoor
Body color (表面颜色)	Black/Dark Gray/Sliver Gray



## Product Description (产品描述)

They are suitable for outdoor lighting in city lanes, narrow lanes, residential neighborhoods, tourist attractions, parks, squares, private gardens courtyards corridors and other public places; the heights can be selected in many ways, which can satisfy different scenarios and desired effects. They create a pleasant atmosphere, add a sense of decoration to the scene and enhance its overall appearance.

## Lightmap (光影图)

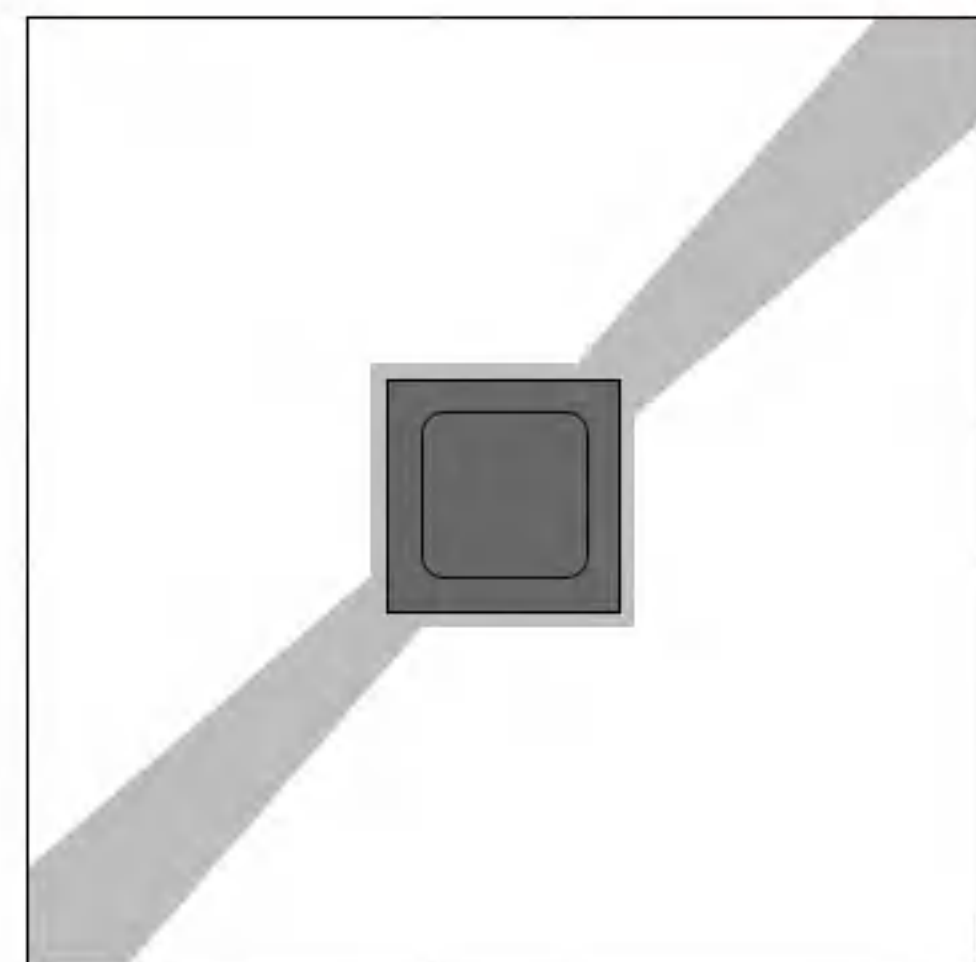

top view (俯视图)

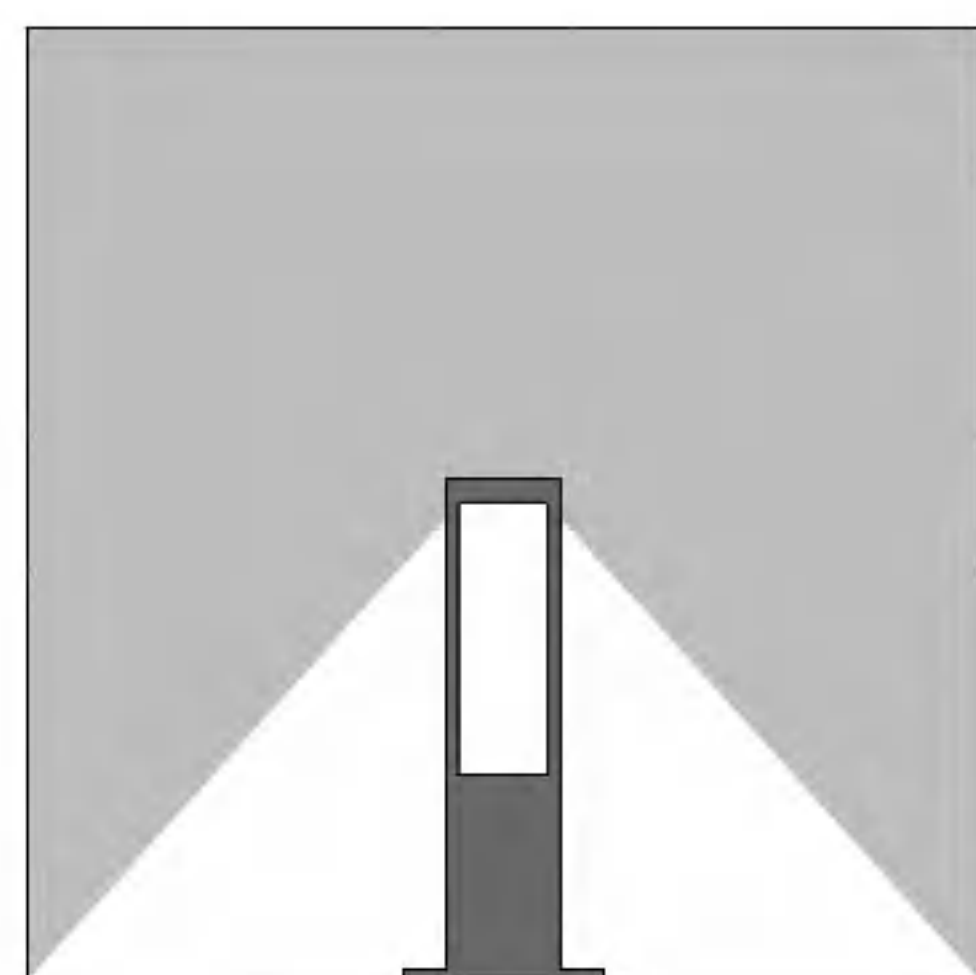

front view (正面图)

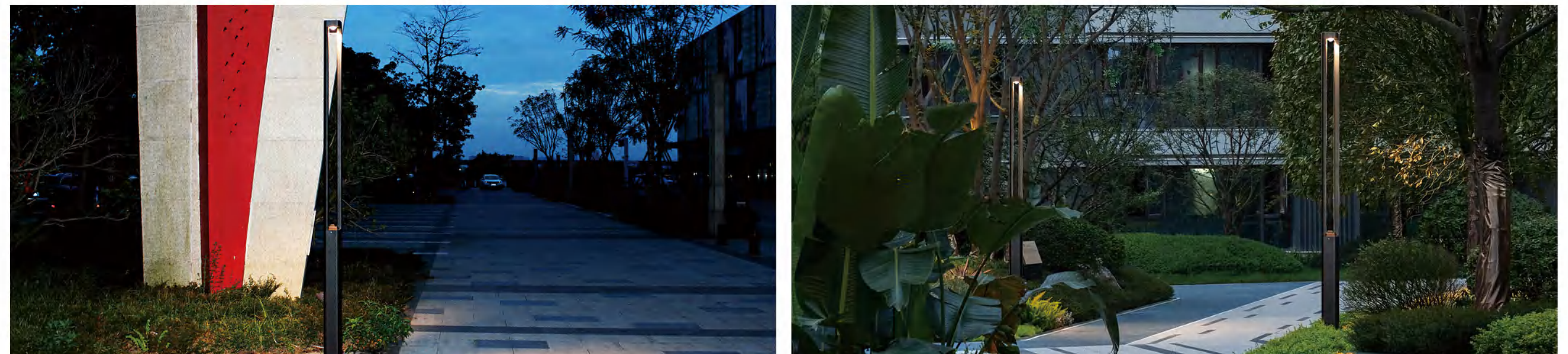

## Technical Date (技术参数)

Item No.	Lamp Type	Power	LM	CCT	PF	Voltage	CRI	A	B	C	D	E (mm)
MB-T007	LED	20W	1400	2700-6000K	0.9	AC110-265V	80-90	120	45	1455	1000	2500



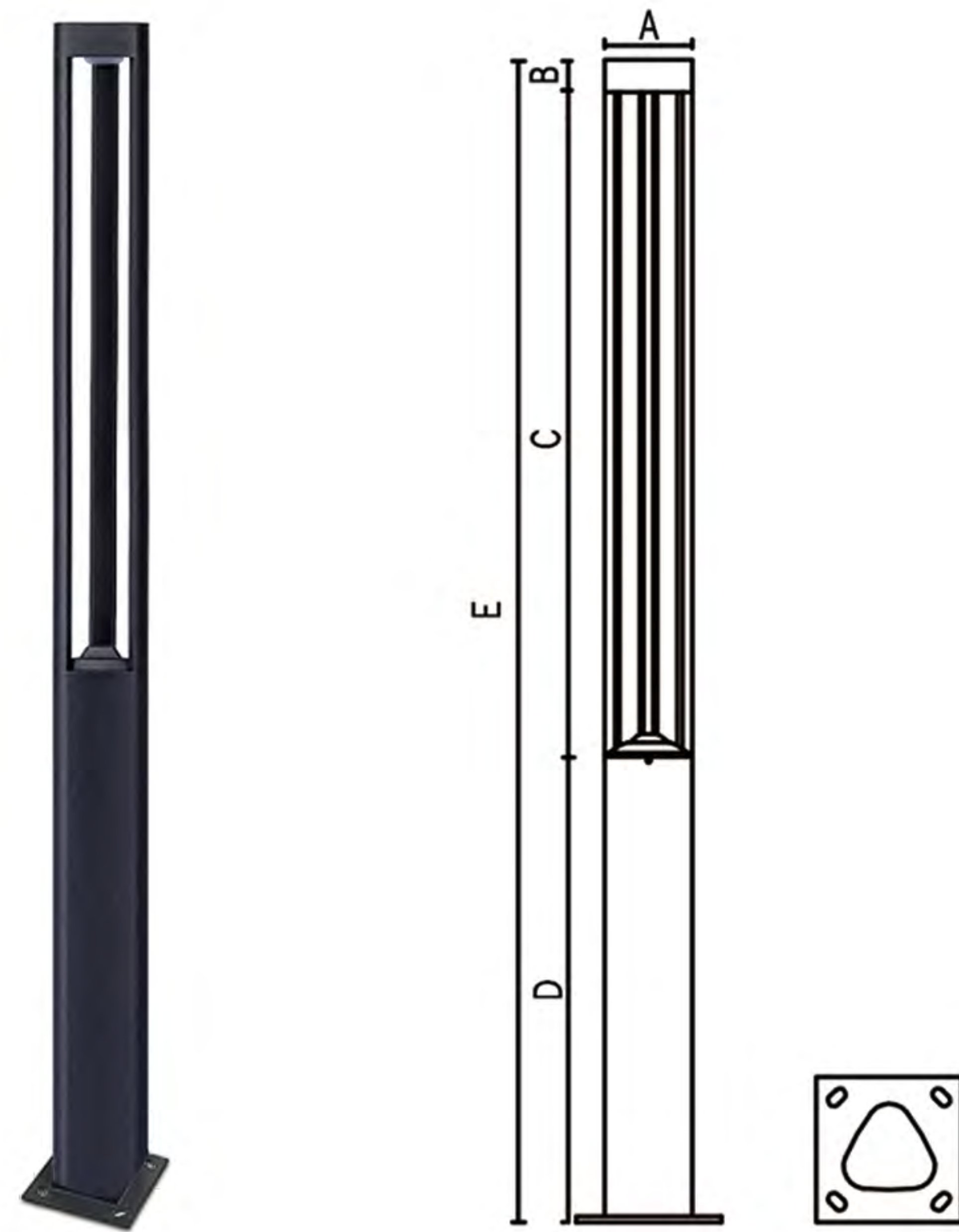

# MB-T008

## Features&Benefit (功能和优点)

Category (品类)	Garden Light
Diffuser Material (扩散器材质)	Glass
Cover Material (面盖材质)	Aluminum
Operating mode (运行)	Built in
Steuerbar (开关)	On/Off
IP (防水等级)	54
Mounting type (安装类型)	Put
Mounting location (安装位置)	Overground
Application environment (应用环境)	Indoor/Outdoor
Body color (表面颜色)	Black/Dark Gray/Sliver Gray



## Product Description (产品描述)

They are suitable for outdoor lighting in city lanes, narrow lanes, residential neighborhoods, tourist attractions, parks, squares, private gardens courtyards corridors and other public places; the heights can be selected in many ways, which can satisfy different scenarios and desired effects. They create a pleasant atmosphere, add a sense of decoration to the scene and enhance its overall appearance.

## Lightmap (光影图)

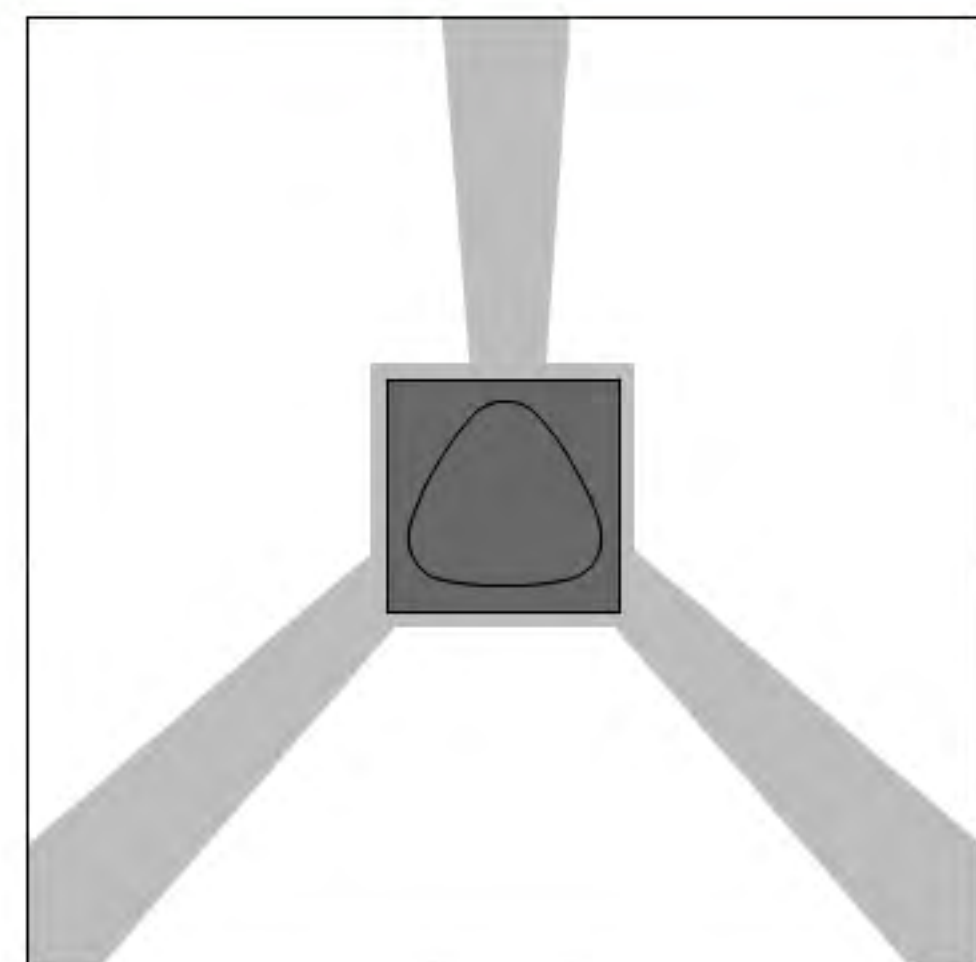

top view (俯视图)

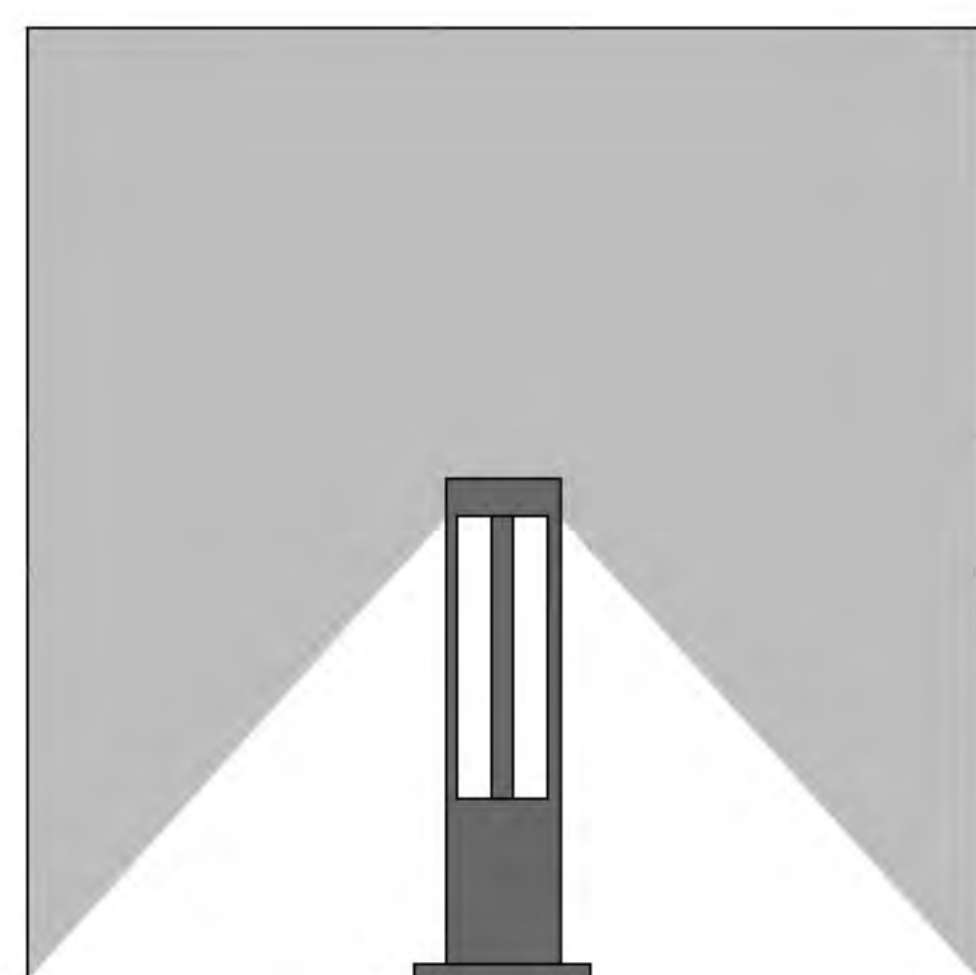

front view (正面图)

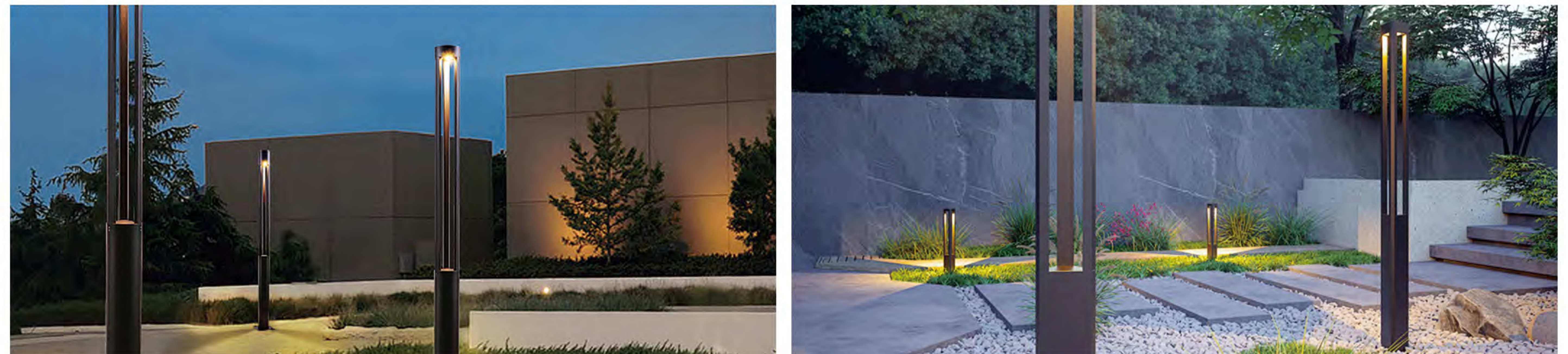

## Technical Date (技术参数)

Item No.	Lamp Type	Power	LM	CCT	PF	Voltage	CRI	A	B	C	D	E (mm)
MB-T008	LED	20W	1400	2700-6000K	0.9	AC110-265V	80-90	120	45	1455	1000	2500



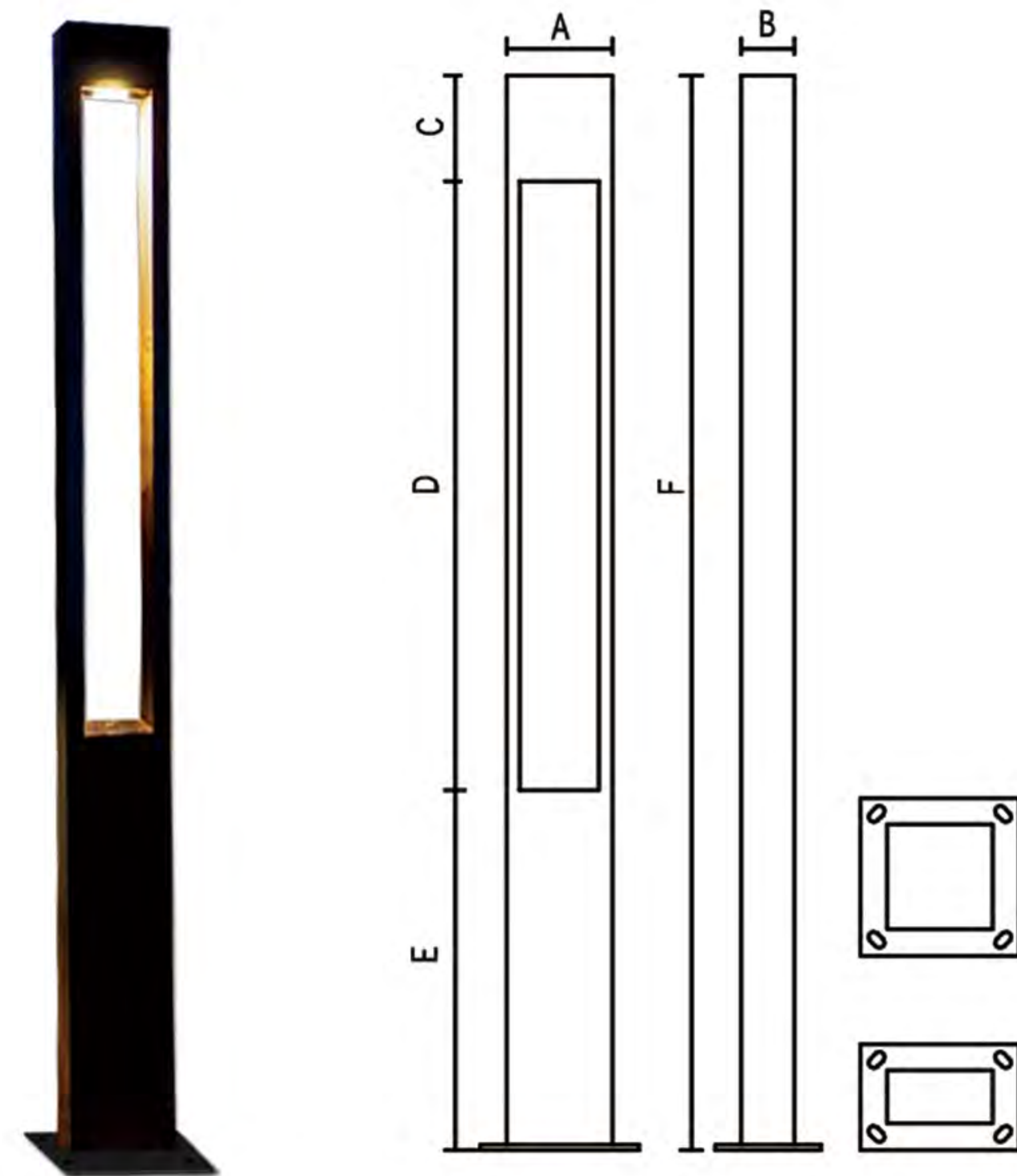

# MB-T009

## Features&Benefit (功能和优点)

Category (品类)	Garden Light
Diffuser Material (扩散器材质)	Glass
Cover Material (面盖材质)	Aluminum
Operating mode (运行)	Built in
Steuerbar (开关)	On/Off
IP (防水等级)	54
Mounting type (安装类型)	Put
Mounting location (安装位置)	Overground
Application environment (应用环境)	Indoor/Outdoor
Body color (表面颜色)	Black/Dark Gray/Sliver Gray



## Product Description (产品描述)

They are suitable for outdoor lighting in city lanes, narrow lanes, residential neighborhoods, tourist attractions, parks, squares, private gardens courtyards corridors and other public places; the heights can be selected in many ways, which can satisfy different scenarios and desired effects. They create a pleasant atmosphere, add a sense of decoration to the scene and enhance its overall appearance.

## Lightmap (光影图)

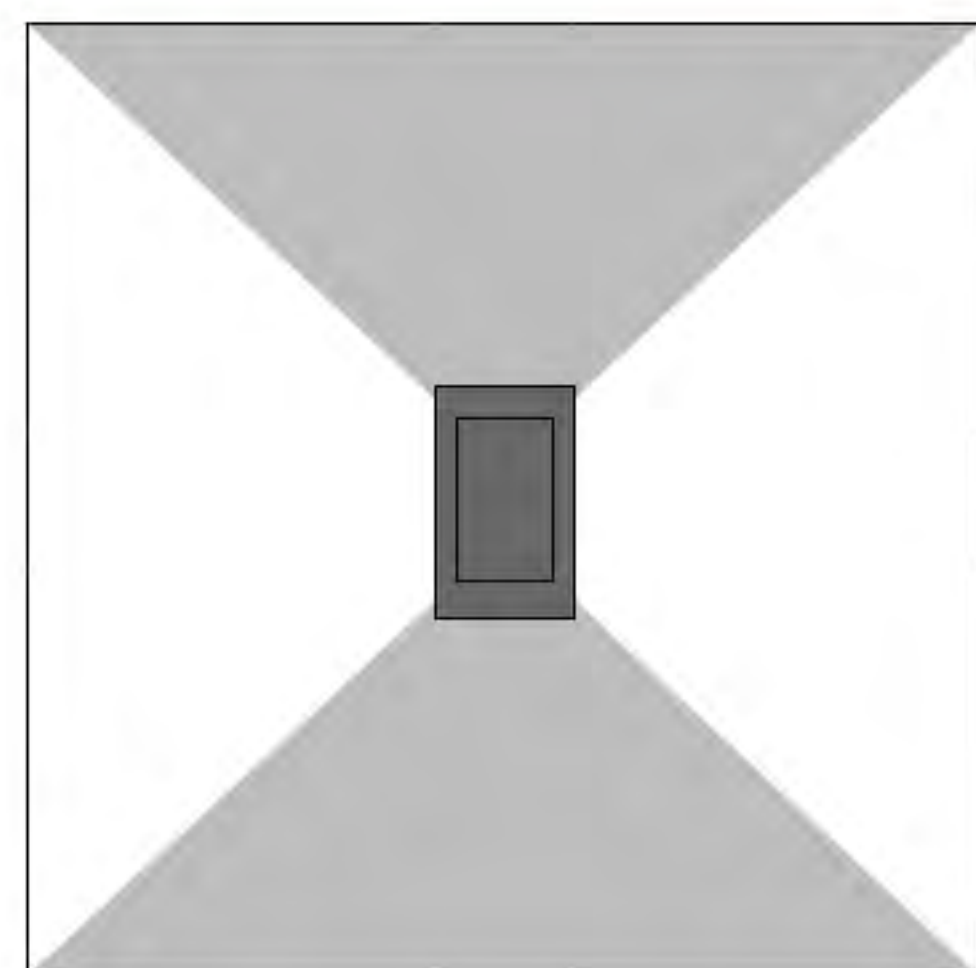

top view (俯视图)

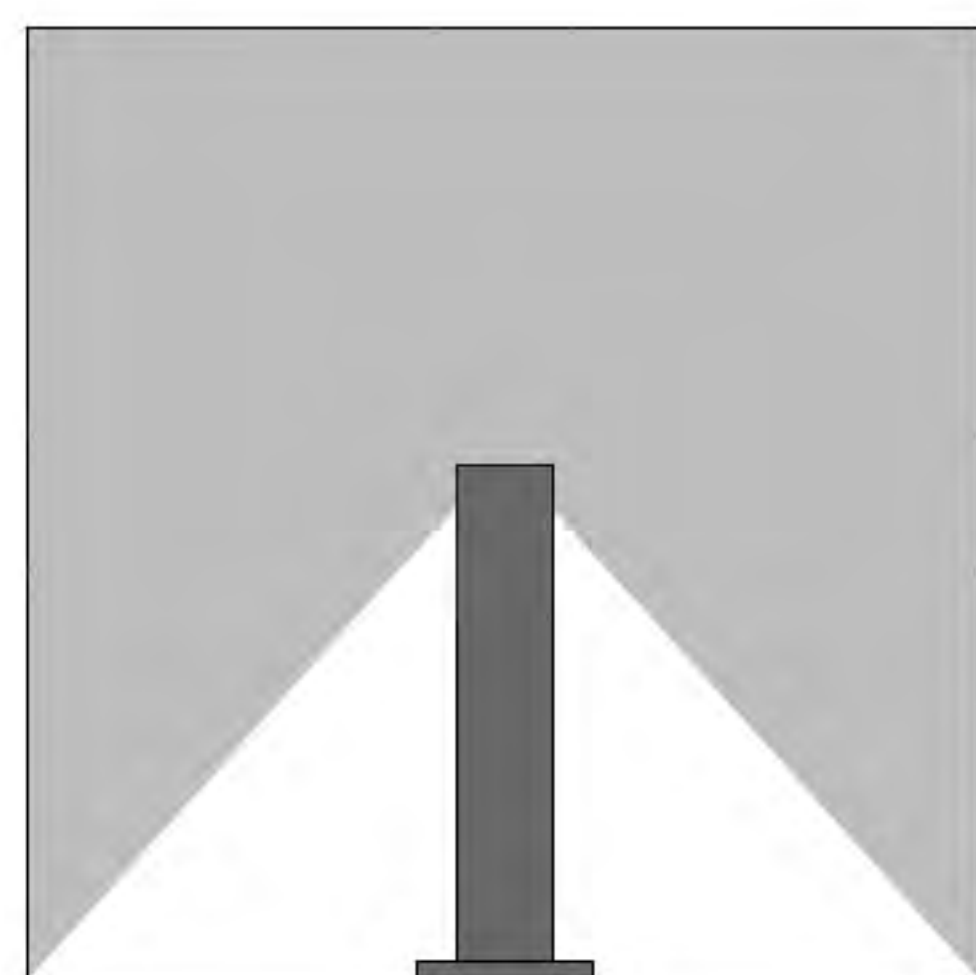

front view (正面图)



## Technical Date (技术参数)

Item No.	Lamp Type	Power	LM	CCT	PF	Voltage	CRI	A	B	C	D	E	F(mm)
MB-T009	LED	20W	1400	2700-6000K	0.9	AC110-265V	80-90	200	100	200	1300	1000	2500
MB-T009/150	LED	20W	1400	2700-6000K	0.9	AC110-265V	80-90	150	150	100	1300	1100	2500
MB-T009/200	LED	30W	2100	2700-6000K	0.9	AC110-265V	80-90	200	200	100	1300	1100	2500



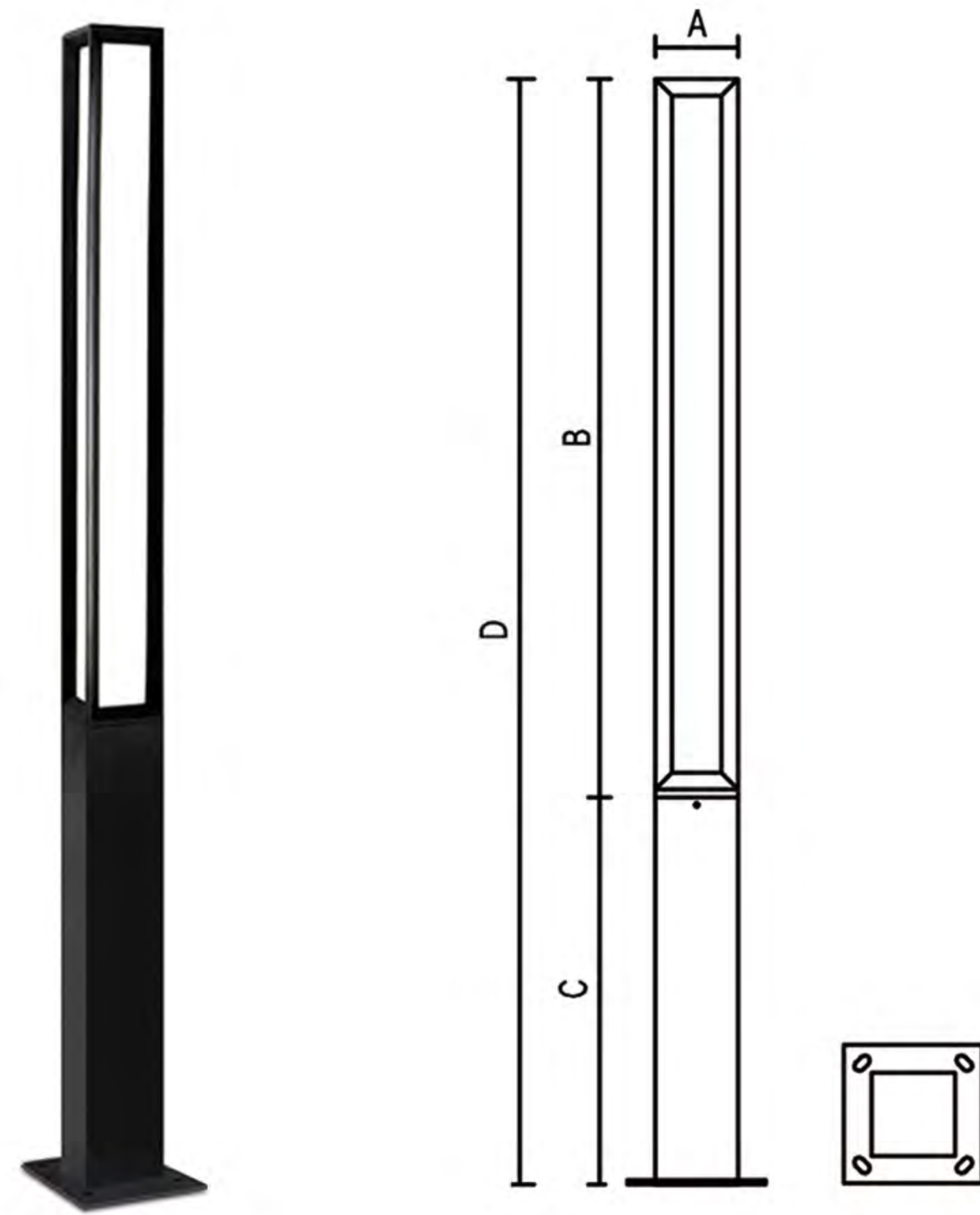

# MB-T010

## Features&Benefit (功能和优点)

Category (品类)	Garden Light
Diffuser Material (扩散器材质)	Acrylic
Cover Material (面盖材质)	Aluminum
Operating mode (运行)	Built in
Steuerbar (开关)	On/Off
IP (防水等级)	54
Mounting type (安装类型)	Put
Mounting location (安装位置)	Overground
Application environment (应用环境)	Indoor/Outdoor
Body color (表面颜色)	Black/Dark Gray/Sliver Gray



## Product Description (产品描述)

They are suitable for outdoor lighting in city lanes, narrow lanes, residential neighborhoods, tourist attractions, parks, squares, private gardens courtyards corridors and other public places; the heights can be selected in many ways, which can satisfy different scenarios and desired effects. They create a pleasant atmosphere, add a sense of decoration to the scene and enhance its overall appearance.

## Lightmap (光影图)

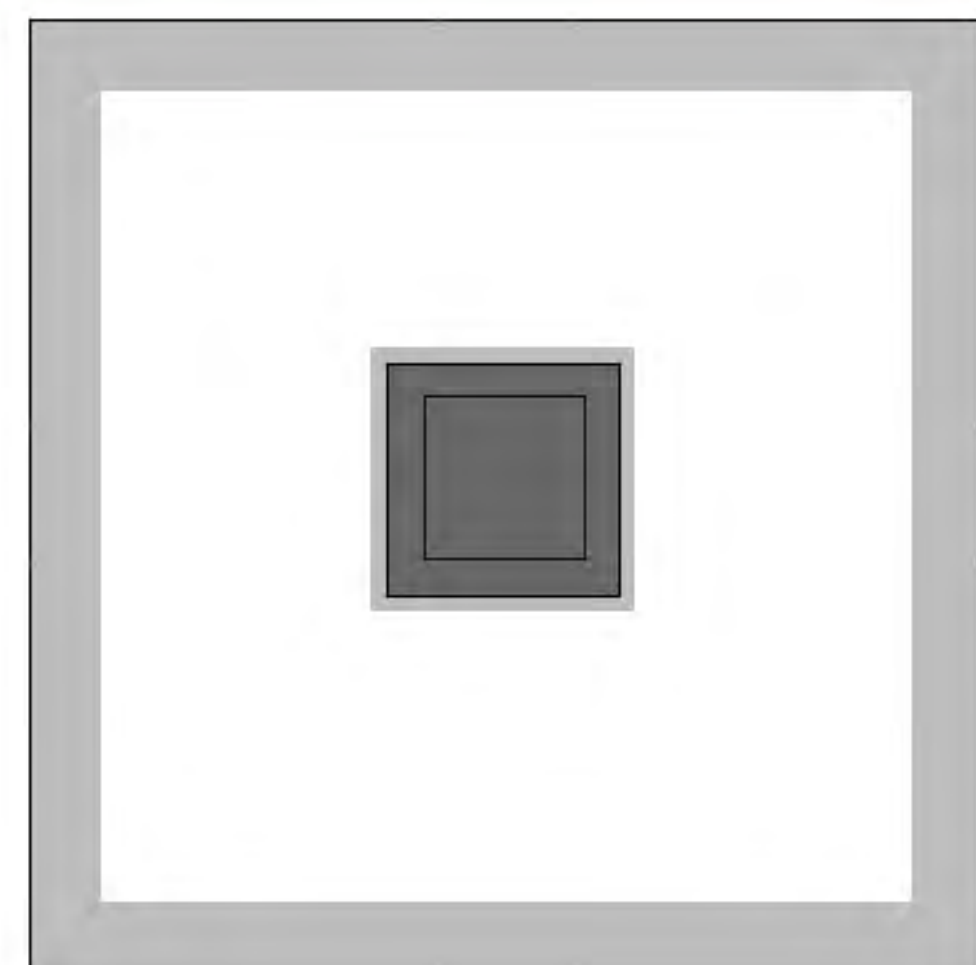

top view (俯视图)

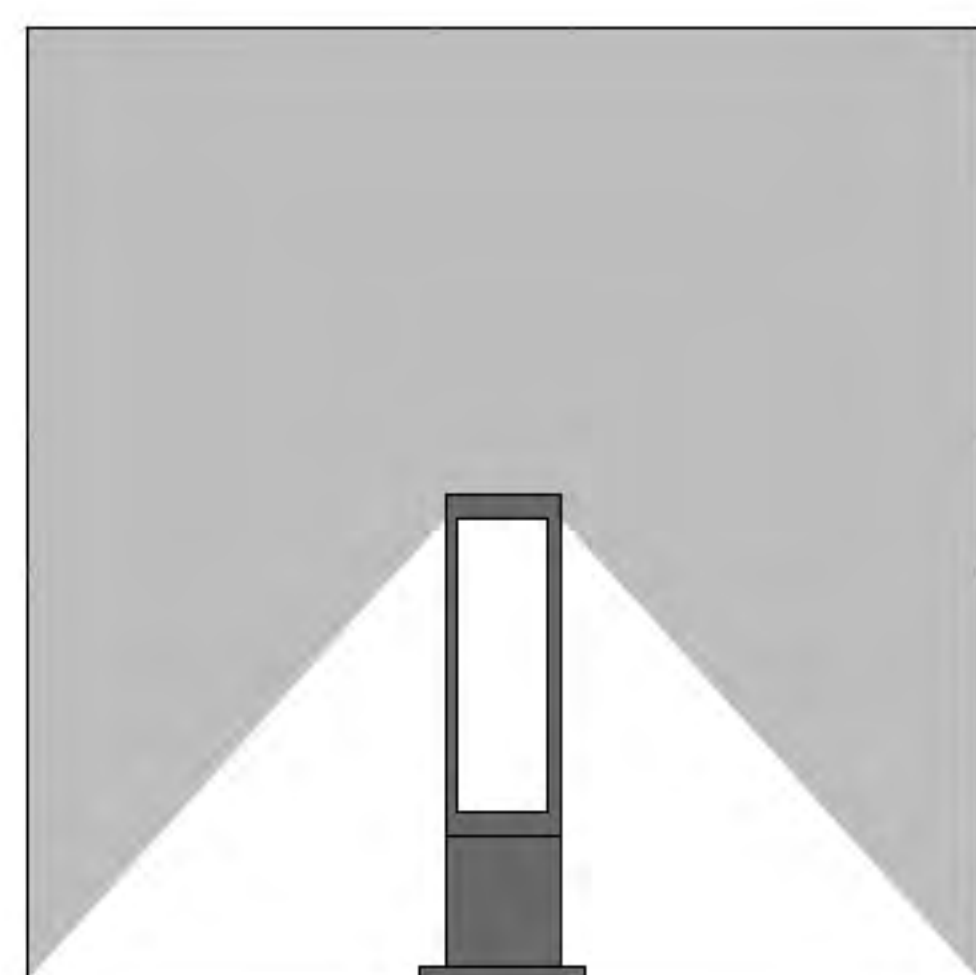

front view (正面图)

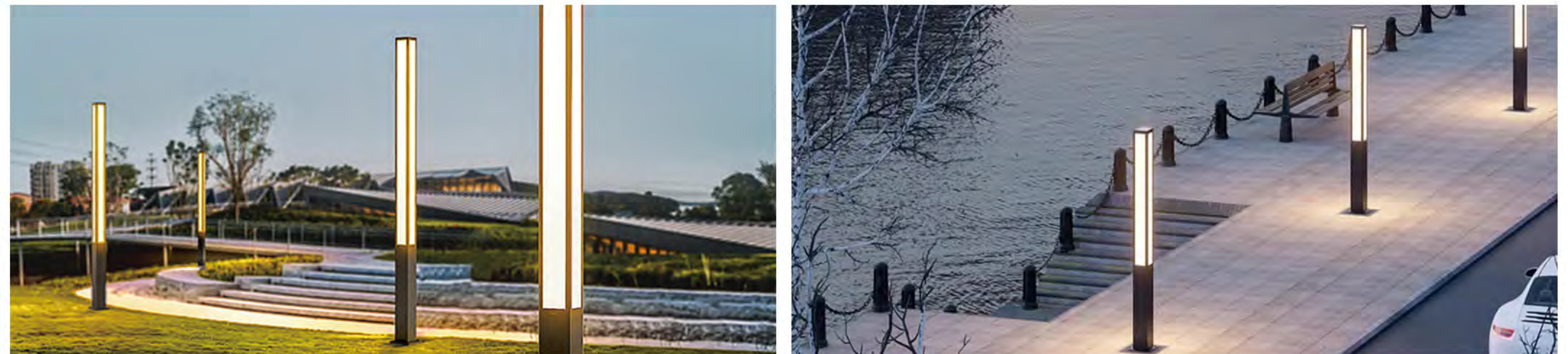

## Technical Date (技术参数)

Item No.	Lamp Type	Power	LM	CCT	PF	Voltage	CRI	A	B	C	D	E (mm)
MB-T010	LED	40W	2800	2700-6000K/RGB	0.9	AC110-265V	80-90	150	1500	1000	2500	-



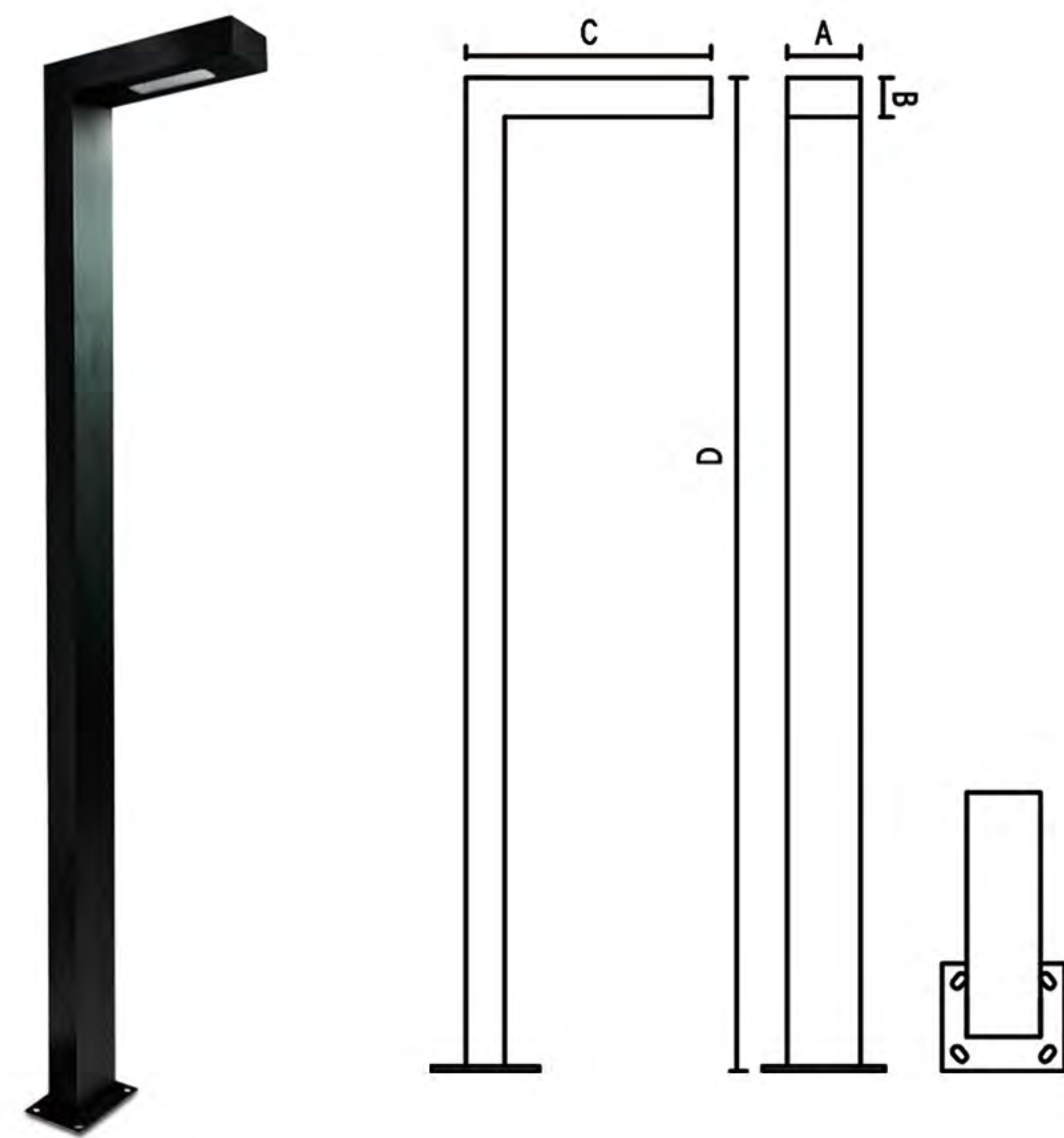

# MB-T011

## Features&Benefit (功能和优点)

Category (品类)	Garden Light
Diffuser Material (扩散器材质)	Acrylic
Cover Material (面盖材质)	Aluminum
Operating mode (运行)	Built in
Steuerbar (开关)	On/Off
IP (防水等级)	54
Mounting type (安装类型)	Put
Mounting location (安装位置)	Overground
Application environment (应用环境)	Indoor/Outdoor
Body color (表面颜色)	Black/Dark Gray/Sliver Gray



## Product Description (产品描述)

They are suitable for outdoor lighting in city lanes, narrow lanes, residential neighborhoods, tourist attractions, parks, squares, private gardens courtyards corridors and other public places; the heights can be selected in many ways, which can satisfy different scenarios and desired effects. They create a pleasant atmosphere, add a sense of decoration to the scene and enhance its overall appearance.

## Lightmap (光影图)

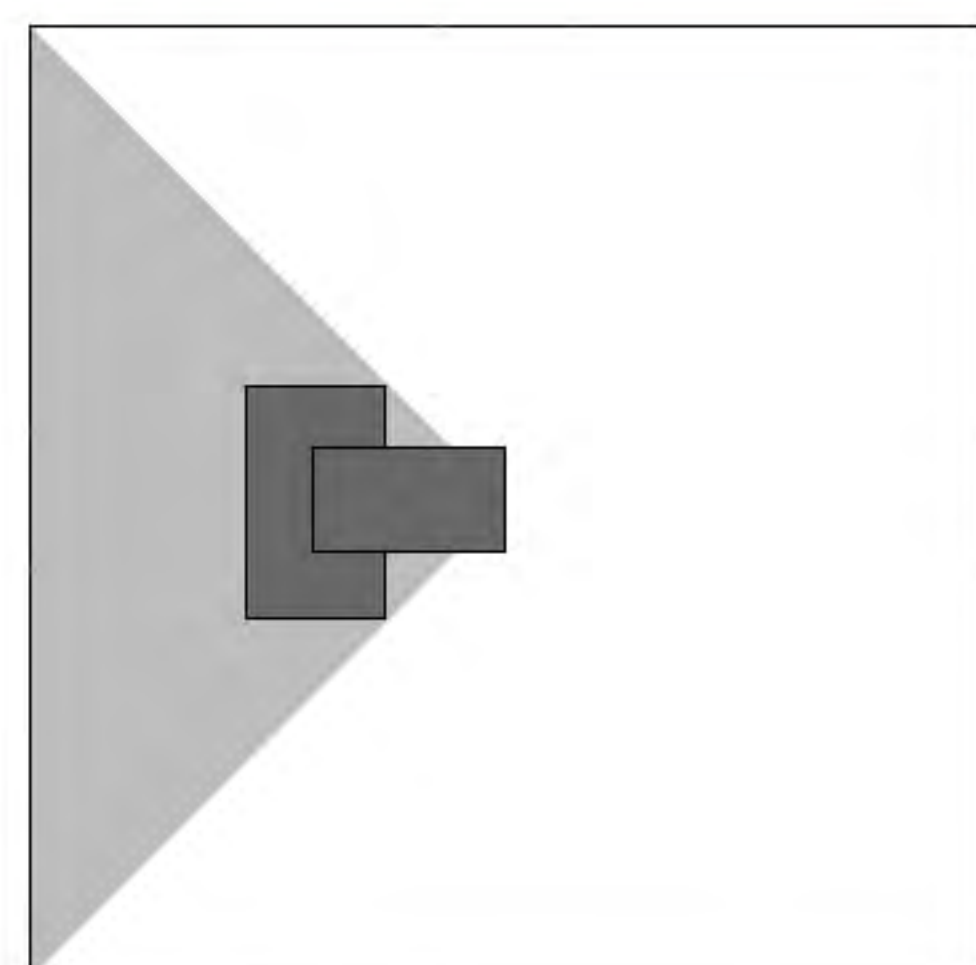

top view (俯视图)

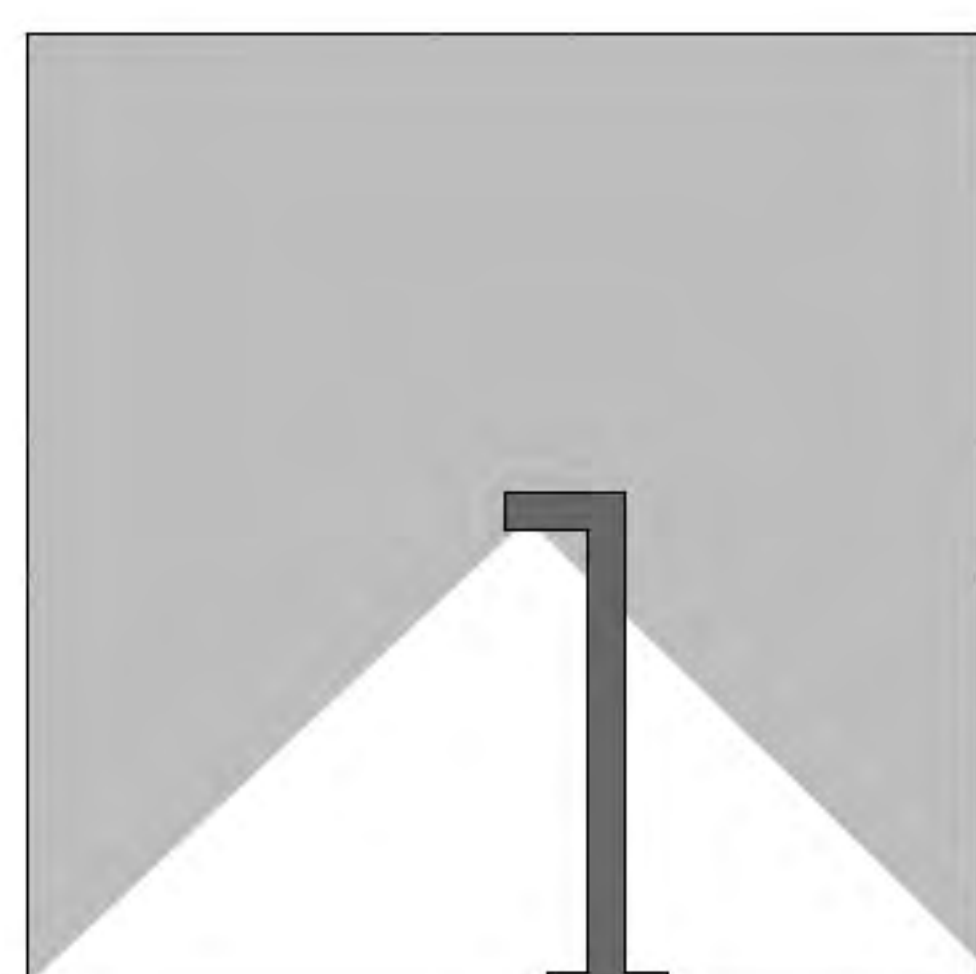

front view (正面图)

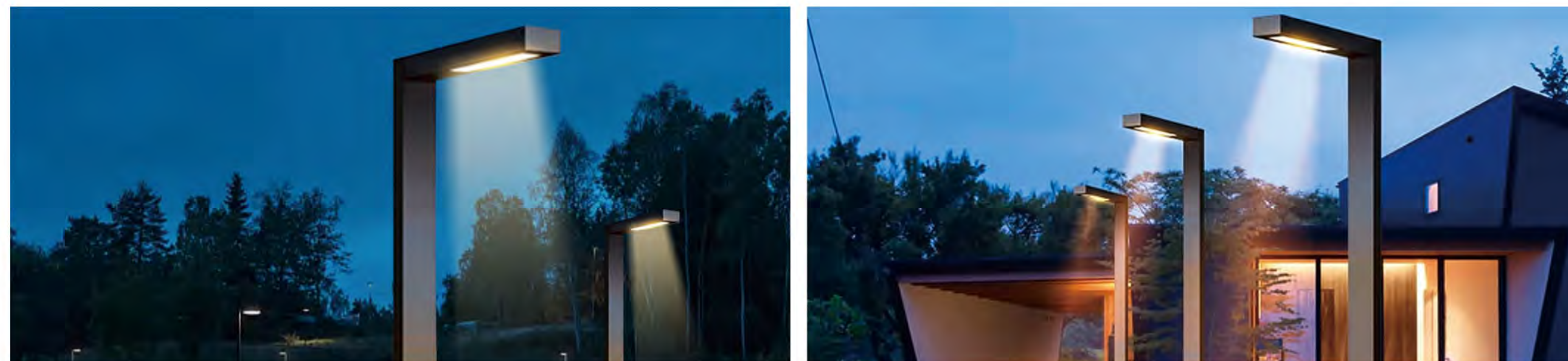

## Technical Date (技术参数)

Item No.	Lamp Type	Power	LM	CCT	PF	Voltage	CRI	A	B	C	D	E (mm)
MB-T011	LED	30W	2100	2700-6000K	0.9	AC110-265V	80-90	150	80	800	3500	-



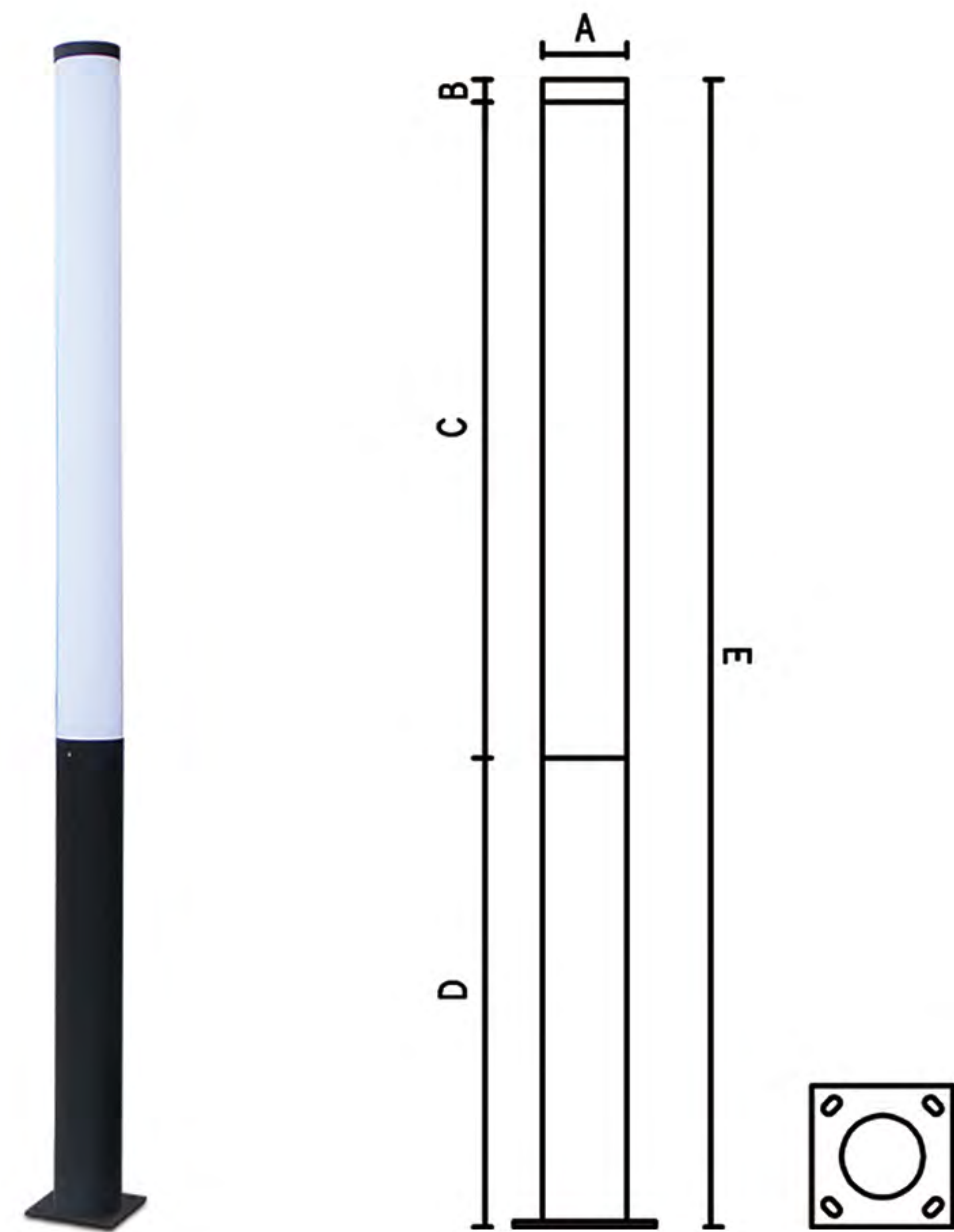

# MB-T012

## Features&Benefit (功能和优点)

Category (品类)	Garden Light
Diffuser Material (扩散器材质)	PC
Cover Material (面盖材质)	Aluminum
Operating mode (运行)	Built in
Steuerbar (开关)	On/Off
IP (防水等级)	54
Mounting type (安装类型)	Put
Mounting location (安装位置)	Overground
Application environment (应用环境)	Indoor/Outdoor
Body color (表面颜色)	Black/Dark Gray/Sliver Gray



## Product Description (产品描述)

They are suitable for outdoor lighting in city lanes, narrow lanes, residential neighborhoods, tourist attractions, parks, squares, private gardens courtyards corridors and other public places; the heights can be selected in many ways, which can satisfy different scenarios and desired effects. They create a pleasant atmosphere, add a sense of decoration to the scene and enhance its overall appearance.

## Lightmap (光影图)

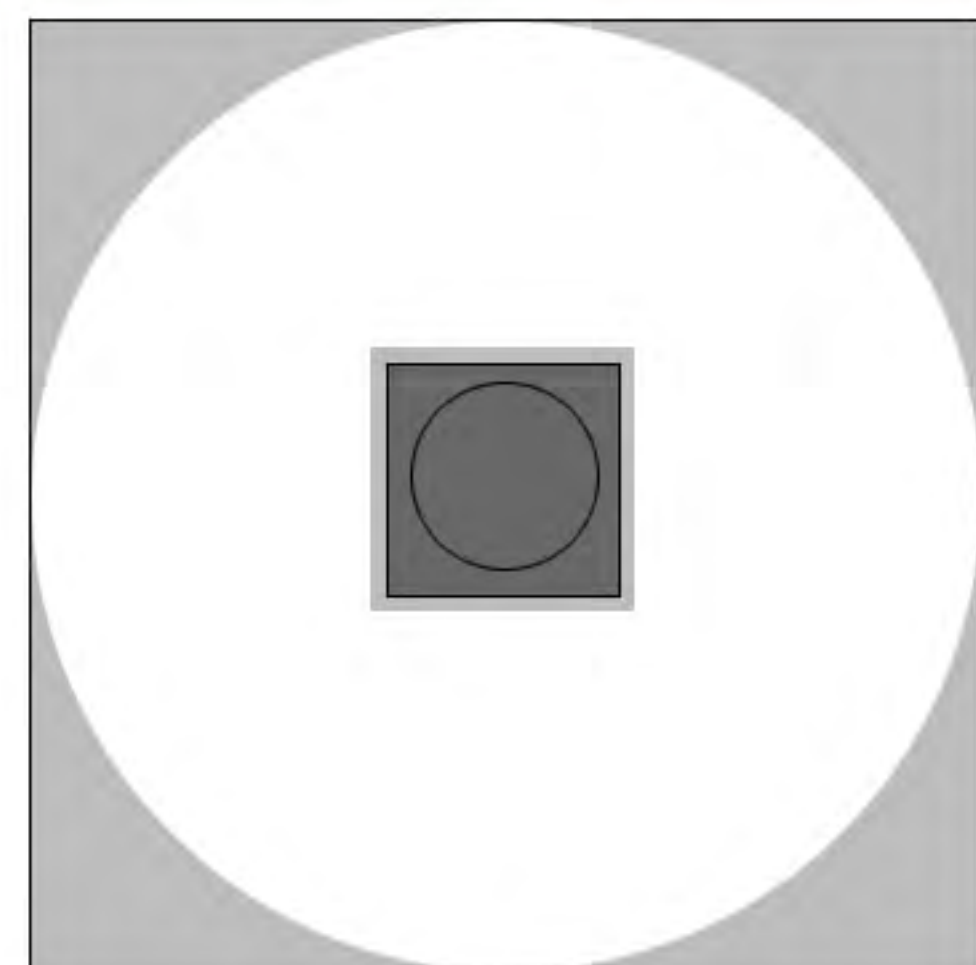

top view (俯视图)

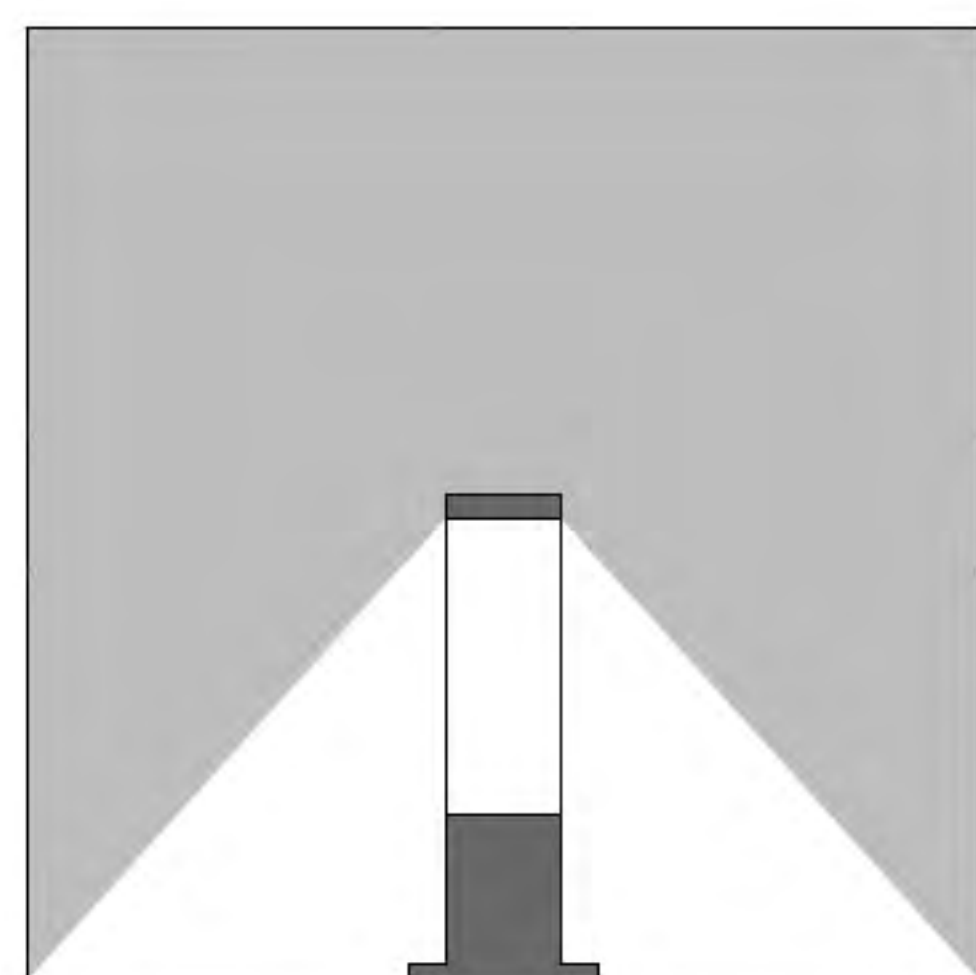

front view (正面图)

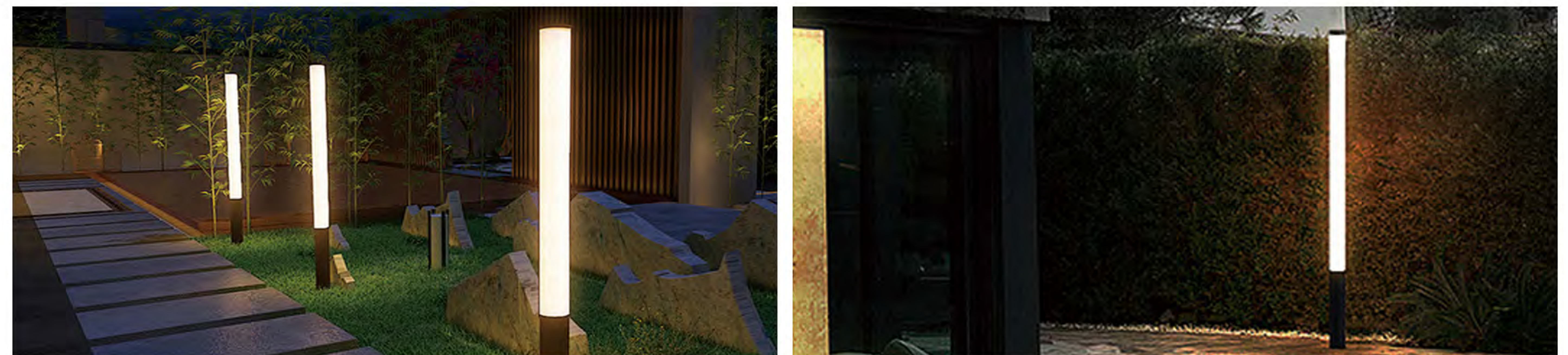

## Technical Date (技术参数)

Item No.	Lamp Type	Power	LM	CCT	PF	Voltage	CRI	A	B	C	D	E (mm)
MB-T012	LED	40W	2800	2700-6000K/RGB	0.9	AC110-265V	80-90	Ø145	30	1470	1000	2500



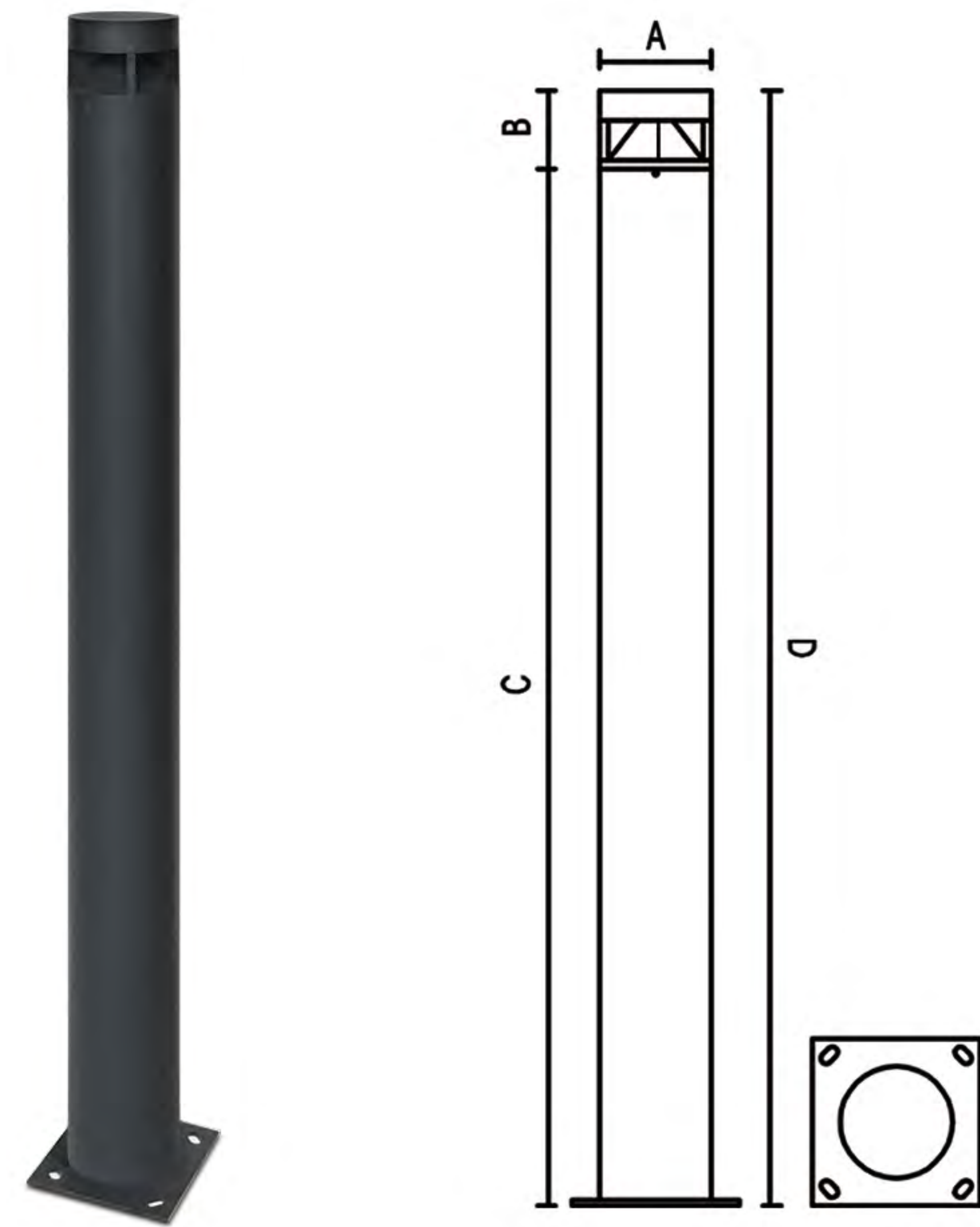

# MB-T013

## Features&Benefit (功能和优点)

Category (品类)	Garden Light
Diffuser Material (扩散器材质)	PC
Cover Material (面盖材质)	Aluminum
Operating made (运行)	Built in
Steuerbar (开关)	On/Off
IP (防水等级)	54
Mounting type (安装类型)	Put
Mounting location (安装位置)	Overground
Application environment (应用环境)	Indoor/Outdoor
Body color (表面颜色)	Black/Dark Gray/Sliver Gray



## Product Description (产品描述)

They are suitable for outdoor lighting in city lanes, narrow lanes, residential neighborhoods, tourist attractions, parks, squares, private gardens courtyards corridors and other public places; the heights can be selected in many ways, which can satisfy different scenarios and desired effects. They create a pleasant atmosphere, add a sense of decoration to the scene and enhance its overall appearance.

## Lightmap (光影图)

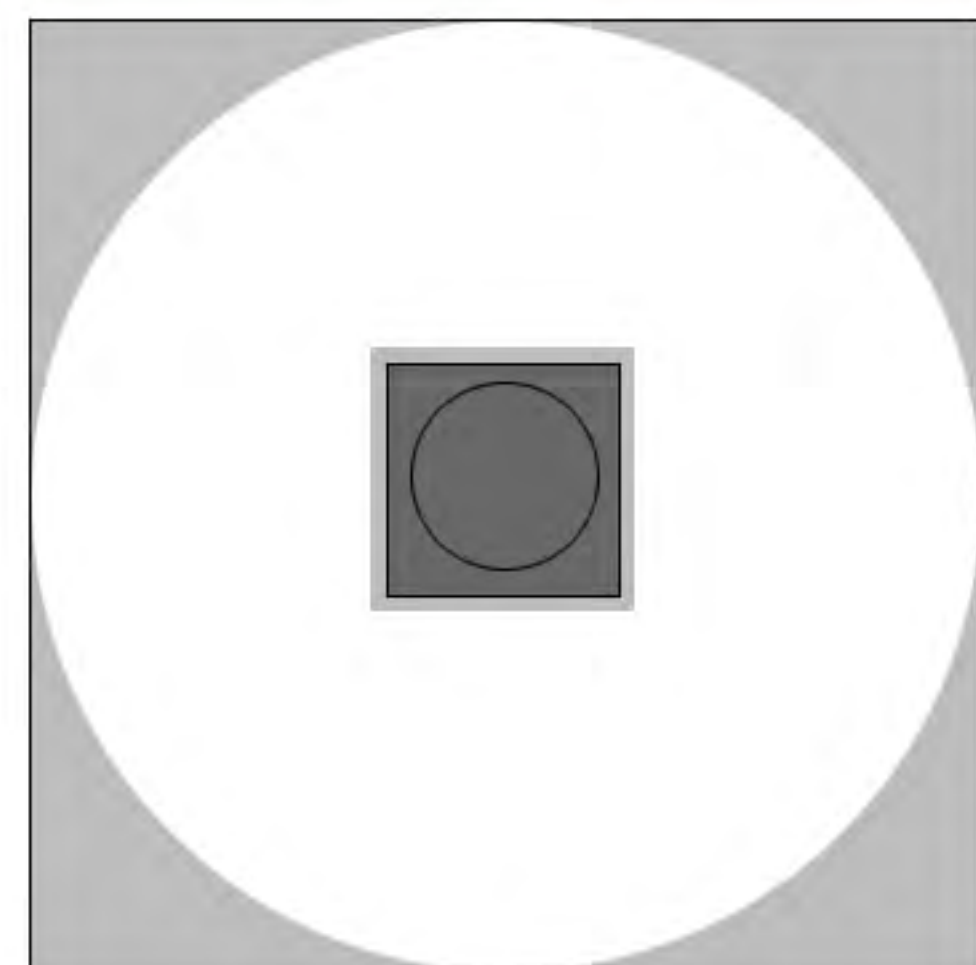

top view (俯视图)

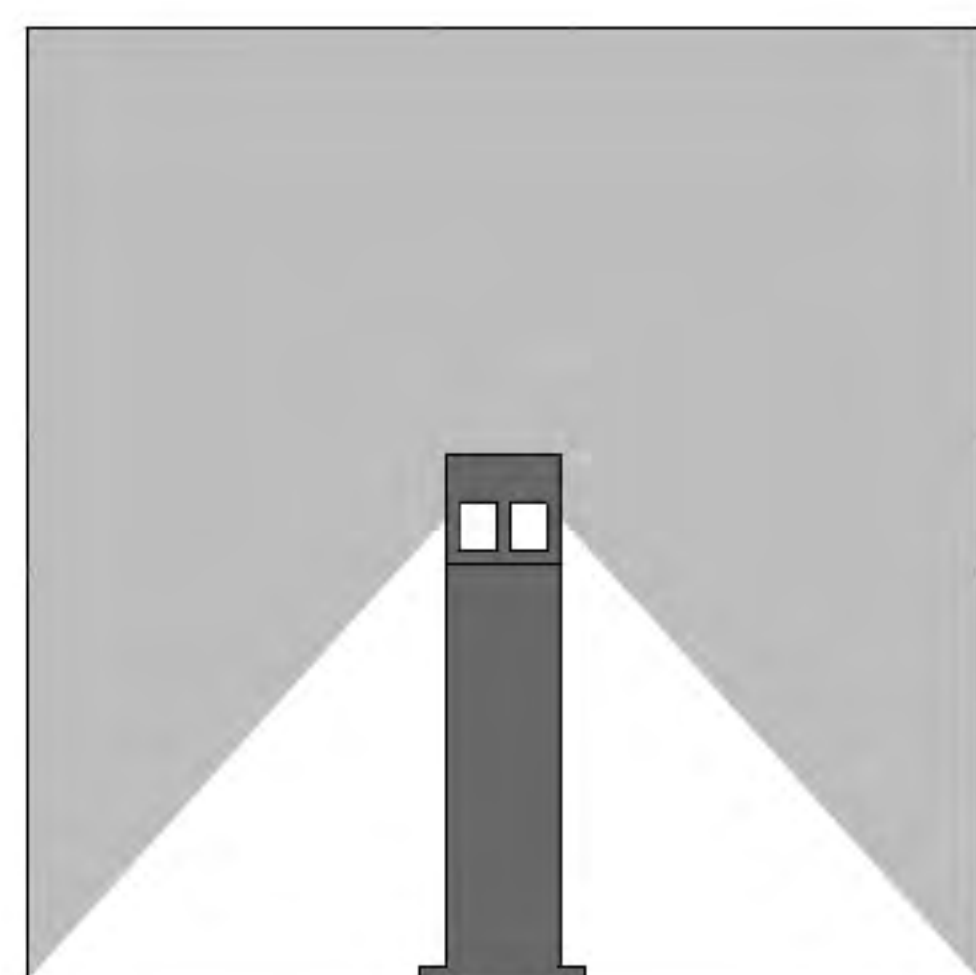

front view (正面图)

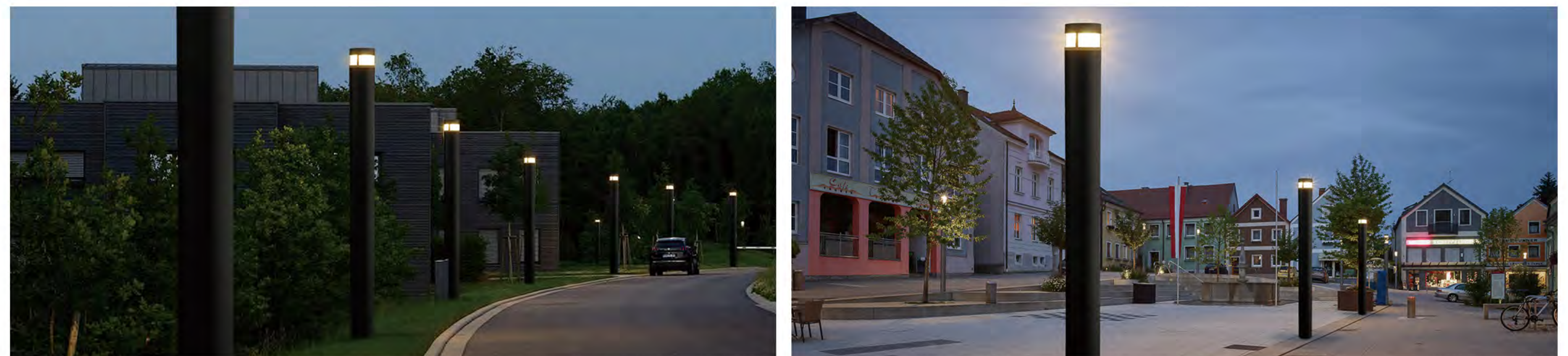

## Technical Date (技术参数)

Item No.	Lamp Type	Power	LM	CCT	PF	Voltage	CRI	A	B	C	D	E (mm)
MB-T013	LED	20W	1400	2700-6000K	0.9	AC110-265V	80-90	Ø200	140	2360	2500	-



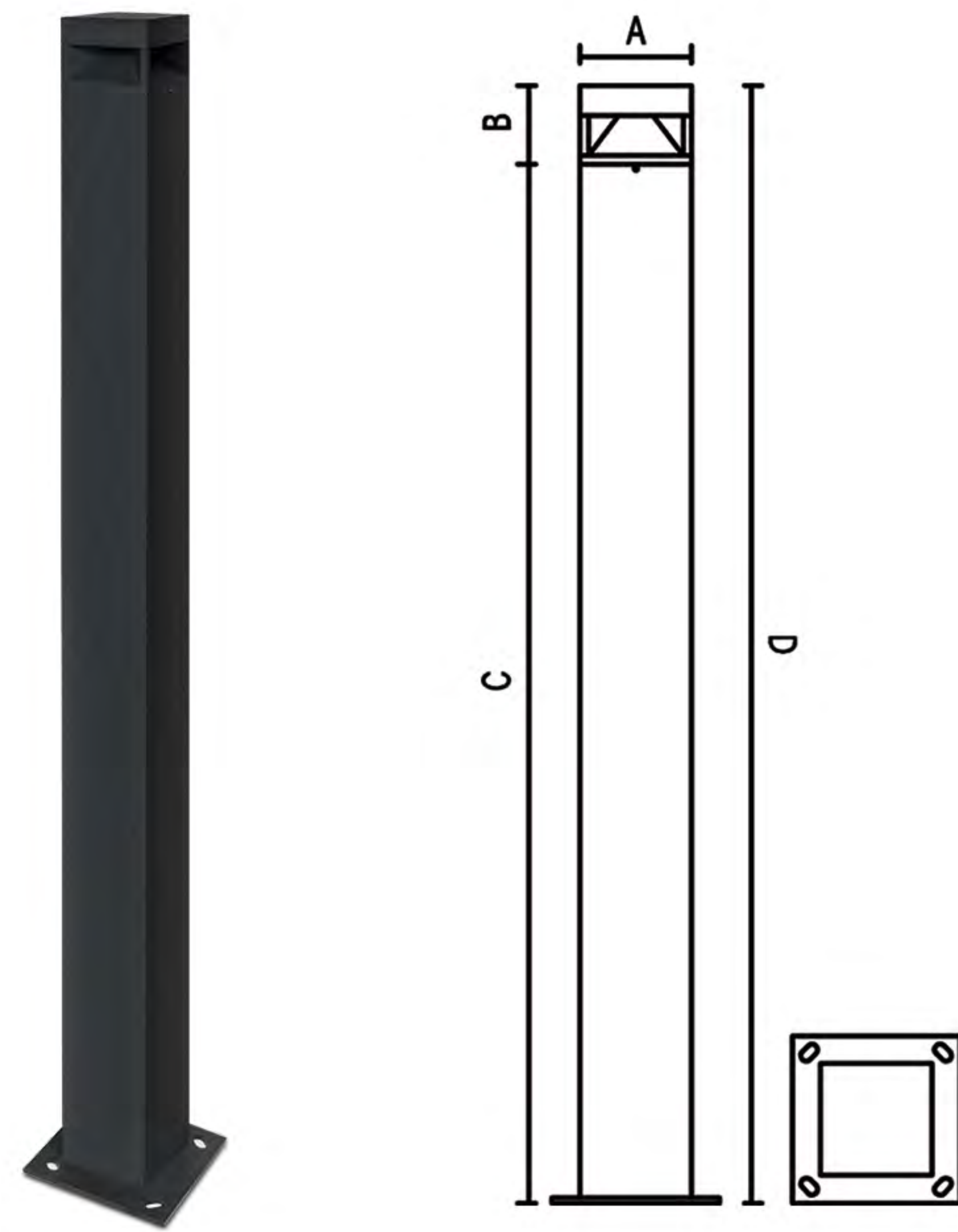

# MB-T014

## Features&Benefit (功能和优点)

Category (品类)	Garden Light
Diffuser Material (扩散器材质)	PC
Cover Material (面盖材质)	Aluminum
Operating made (运行)	Built in
Steuerbar (开关)	On/Off
IP (防水等级)	54
Mounting type (安装类型)	Put
Mounting location (安装位置)	Overground
Application environment (应用环境)	Indoor/Outdoor
Body color (表面颜色)	Black/Dark Gray/Sliver Gray



## Product Description (产品描述)

They are suitable for outdoor lighting in city lanes, narrow lanes, residential neighborhoods, tourist attractions, parks, squares, private gardens courtyards corridors and other public places; the heights can be selected in many ways, which can satisfy different scenarios and desired effects. They create a pleasant atmosphere, add a sense of decoration to the scene and enhance its overall appearance.

## Lightmap (光影图)

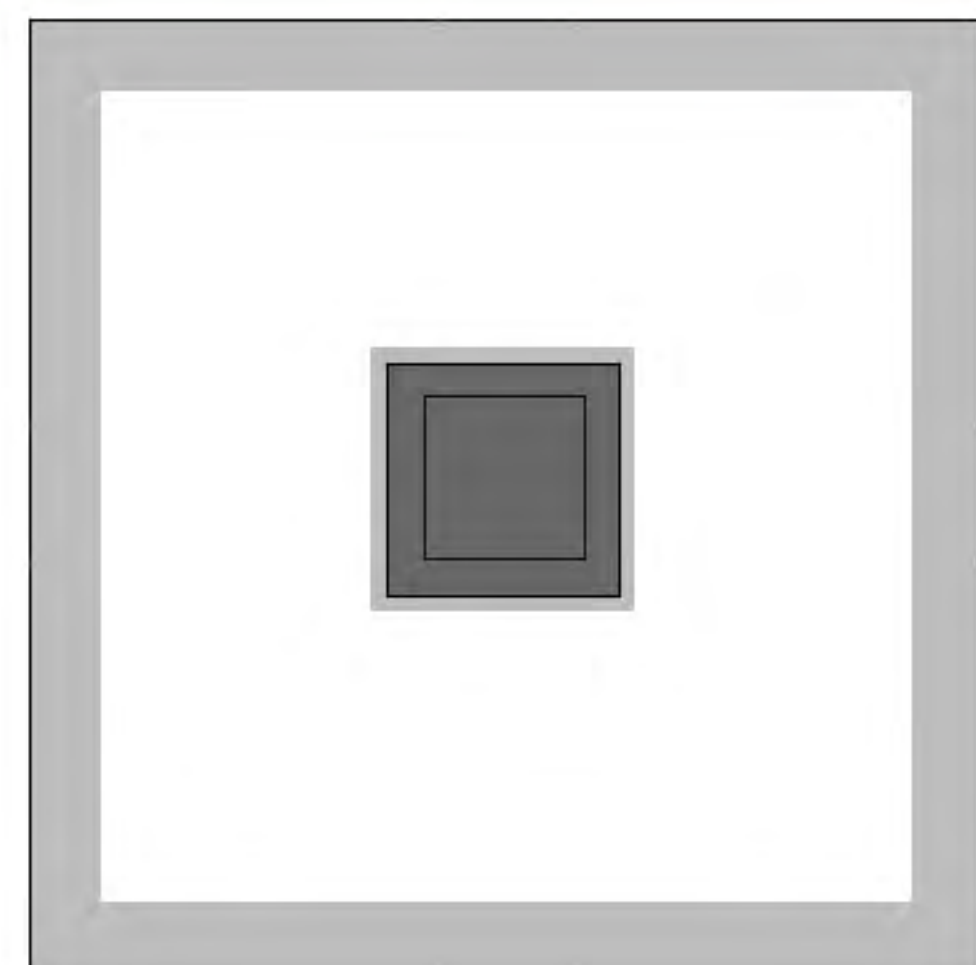

top view (俯视图)

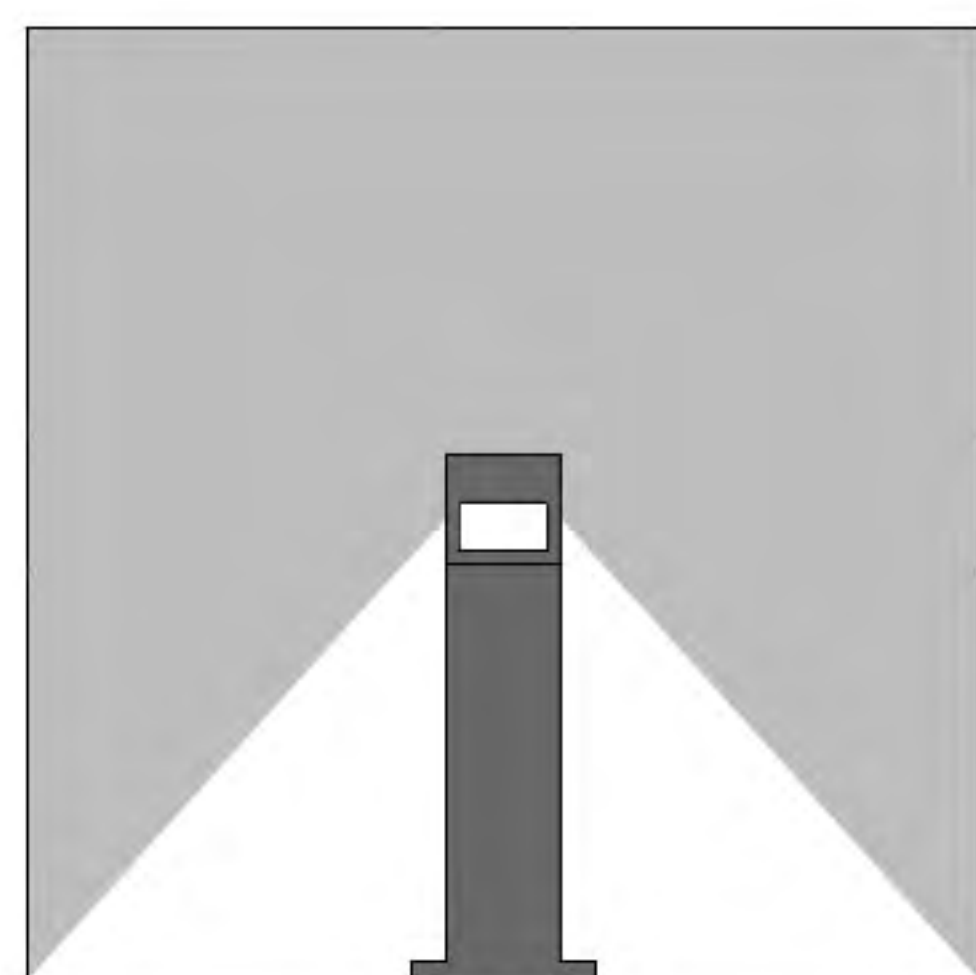

front view (正面图)

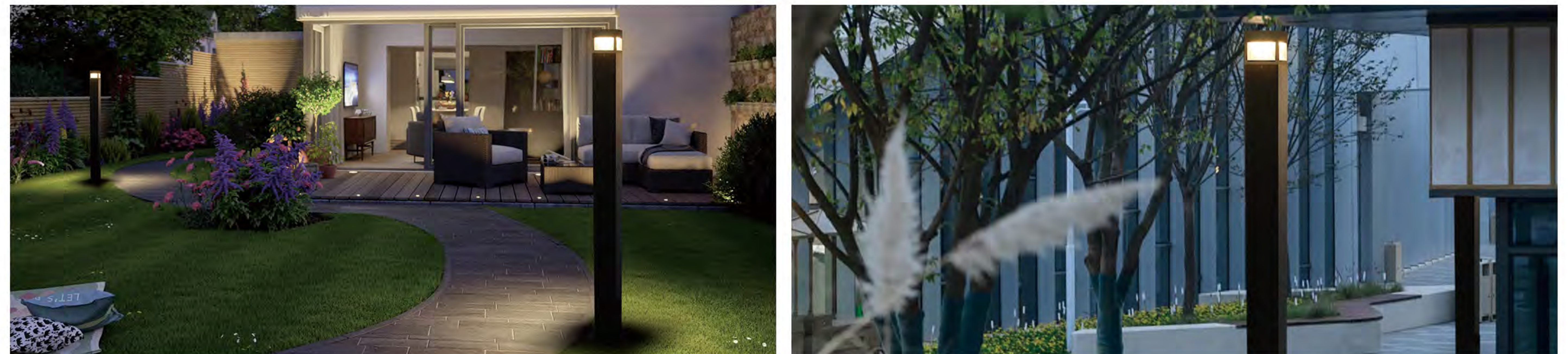

## Technical Date (技术参数)

Item No.	Lamp Type	Power	LM	CCT	PF	Voltage	CRI	A	B	C	D	E (mm)
MB-T014	LED	20W	1400	2700-6000K	0.9	AC110-265V	80-90	200	140	2360	2500	-



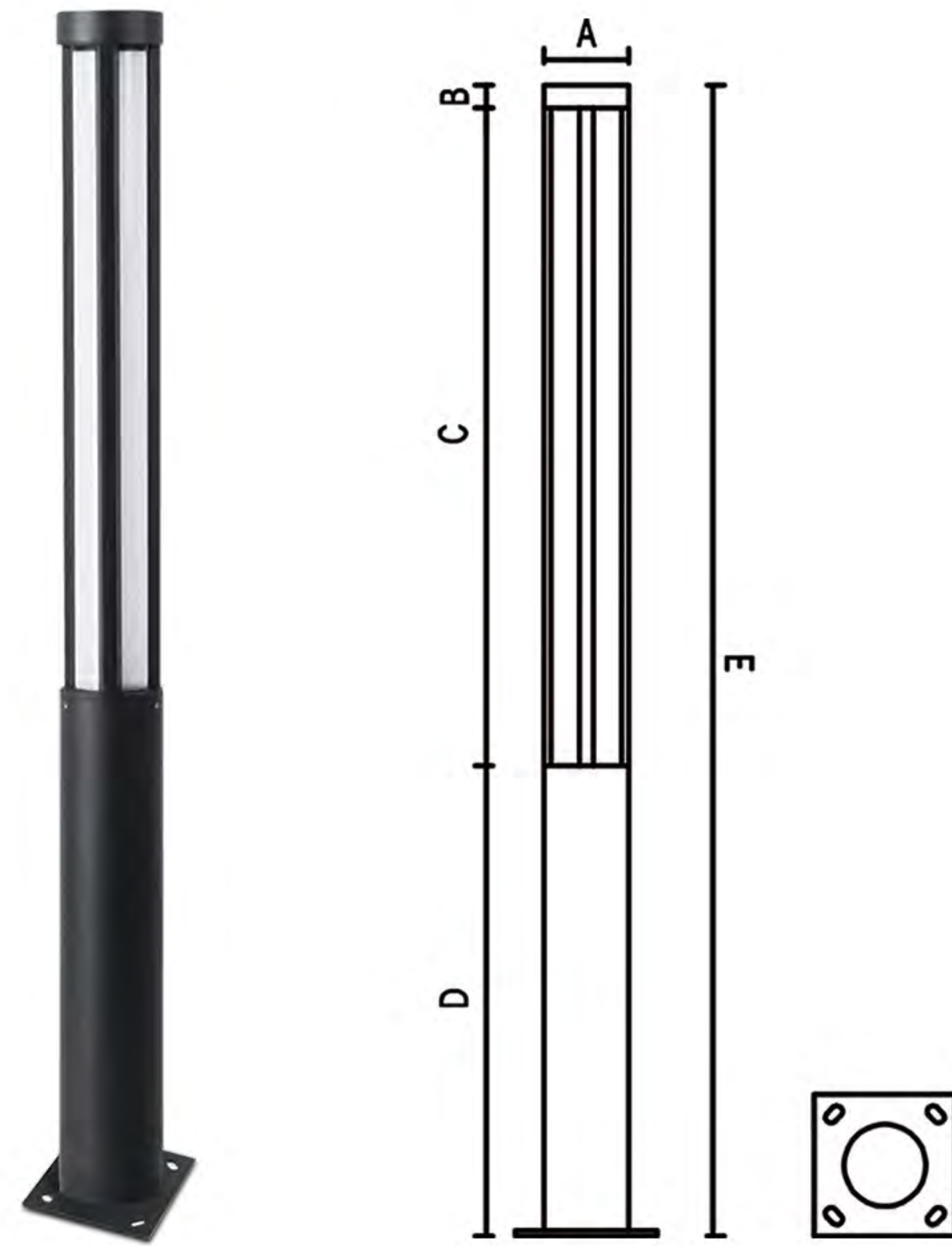

# MB-T015

## Features&Benefit (功能和优点)

Category (品类)	Garden Light
Diffuser Material (扩散器材质)	PC
Cover Material (面盖材质)	Aluminum
Operating mode (运行)	Built in
Steuerbar (开关)	On/Off
IP (防水等级)	54
Mounting type (安装类型)	Put
Mounting location (安装位置)	Overground
Application environment (应用环境)	Indoor/Outdoor
Body color (表面颜色)	Black/Dark Gray/Sliver Gray



## Product Description (产品描述)

They are suitable for outdoor lighting in city lanes, narrow lanes, residential neighborhoods, tourist attractions, parks, squares, private gardens courtyards corridors and other public places; the heights can be selected in many ways, which can satisfy different scenarios and desired effects. They create a pleasant atmosphere, add a sense of decoration to the scene and enhance its overall appearance.

## Lightmap (光影图)

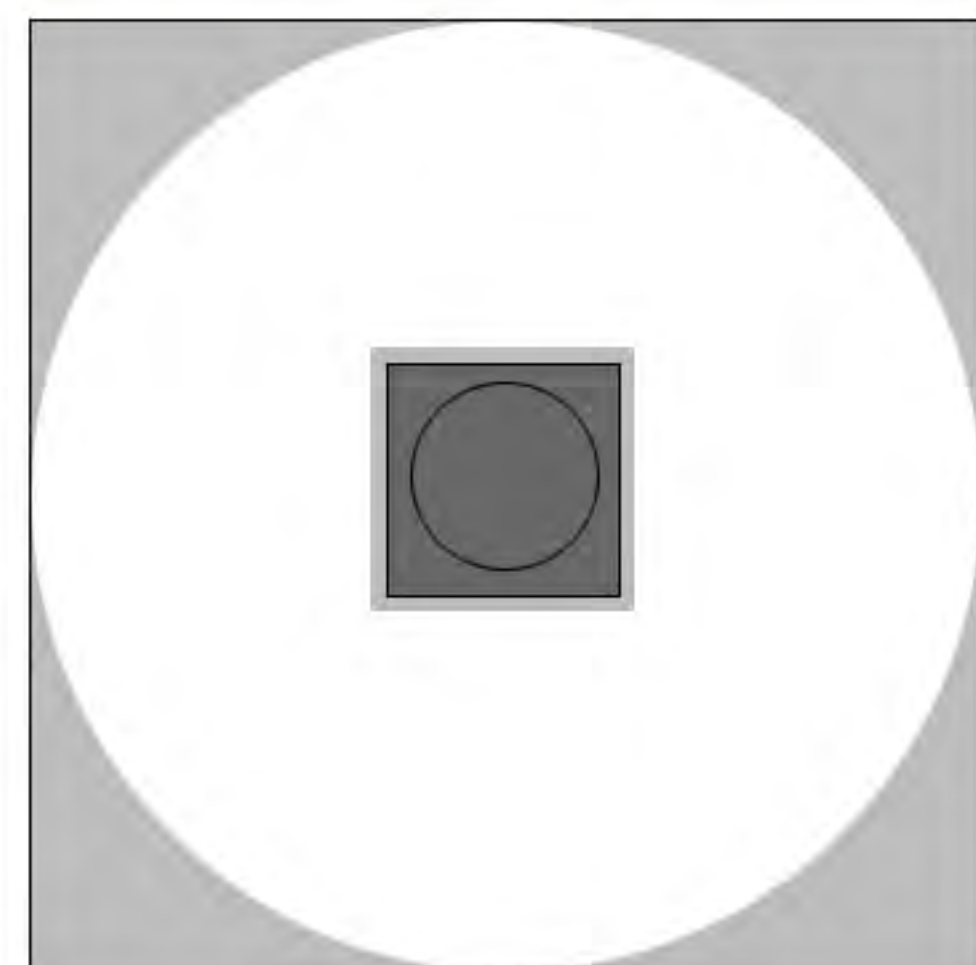

top view (俯视图)

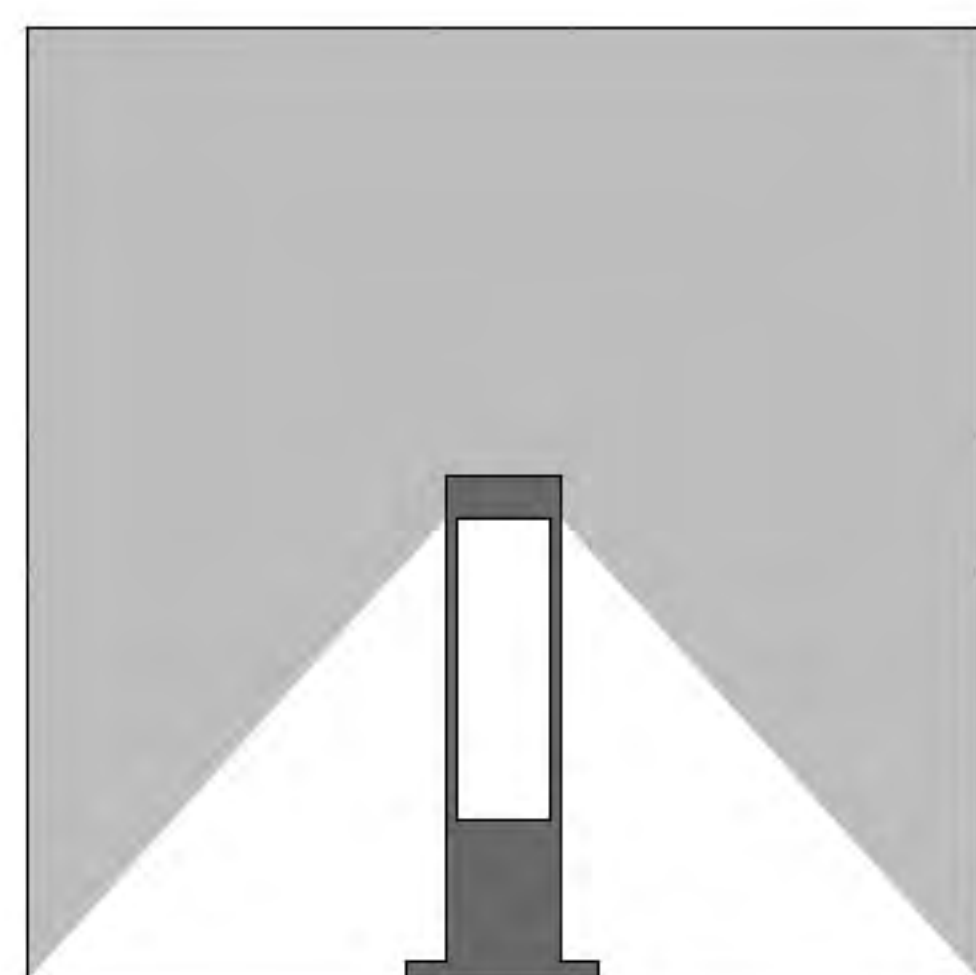

front view (正面图)



## Technical Date (技术参数)

Item No.	Lamp Type	Power	LM	CCT	PF	Voltage	CRI	A	B	C	D	E (mm)
MB-T015A	LED	40W	2800	2700-6000K/RGB	0.9	AC110-265V	80-90	Ø150	50	1470	1000	2500
MB-T015B	LED	40W	2800	2700-6000K/RGB	0.9	AC110-265V	80-90	Ø200	55	1445	1000	2500



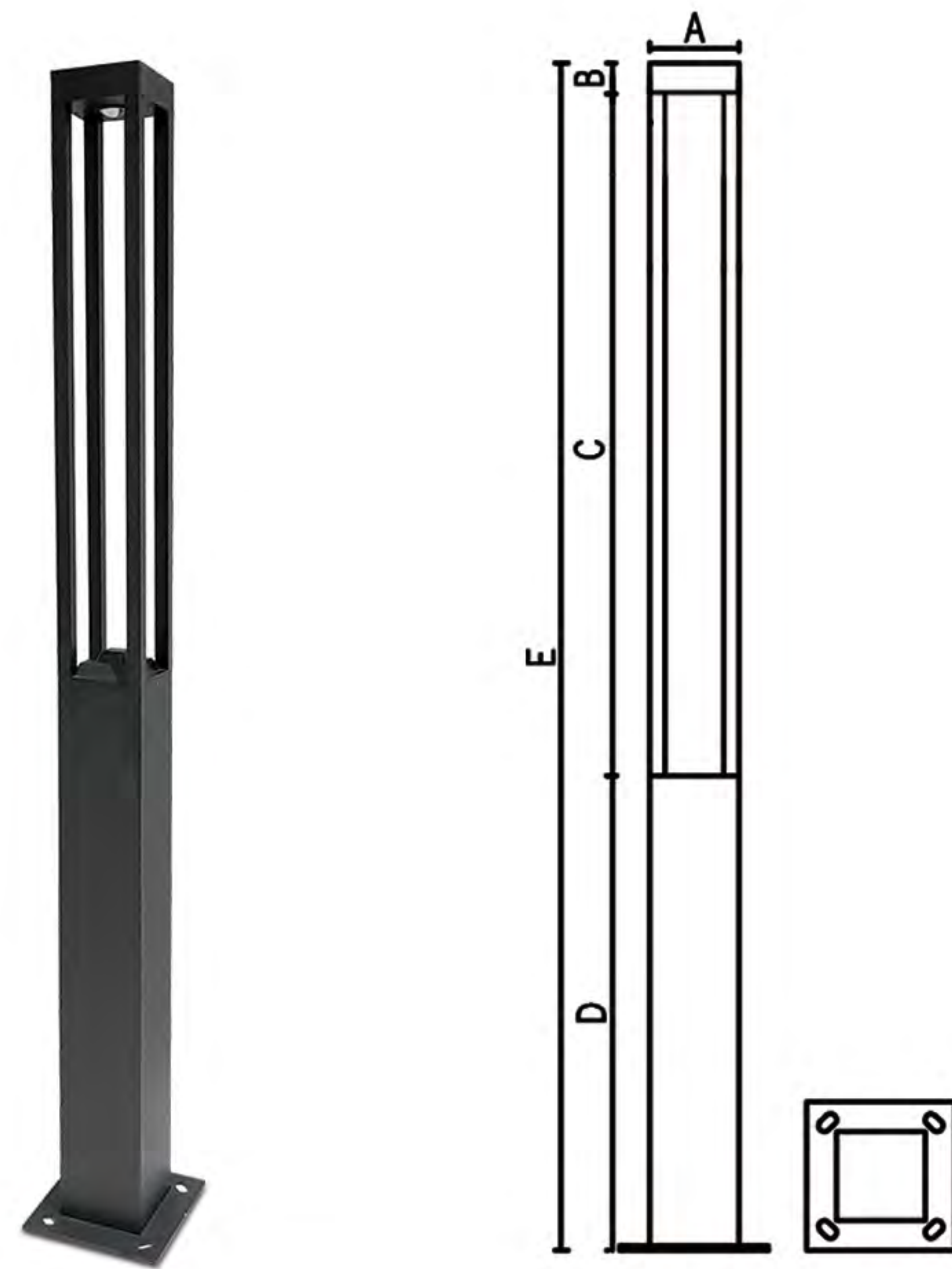

# MB-T016

## Features&Benefit (功能和优点)

Category (品类)	Garden Light
Diffuser Material (扩散器材质)	Glass
Cover Material (面盖材质)	Aluminum
Operating made (运行)	Built in
Steuerbar (开关)	On/Off
IP (防水等级)	54
Mounting type (安装类型)	Put
Mounting location (安装位置)	Overground
Application environment (应用环境)	Indoor/Outdoor
Body color (表面颜色)	Black/Dark Gray/Sliver Gray



## Product Description (产品描述)

They are suitable for outdoor lighting in city lanes, narrow lanes, residential neighborhoods, tourist attractions, parks, squares, private gardens courtyards corridors and other public places; the heights can be selected in many ways, which can satisfy different scenarios and desired effects. They create a pleasant atmosphere, add a sense of decoration to the scene and enhance its overall appearance.

## Lightmap (光影图)

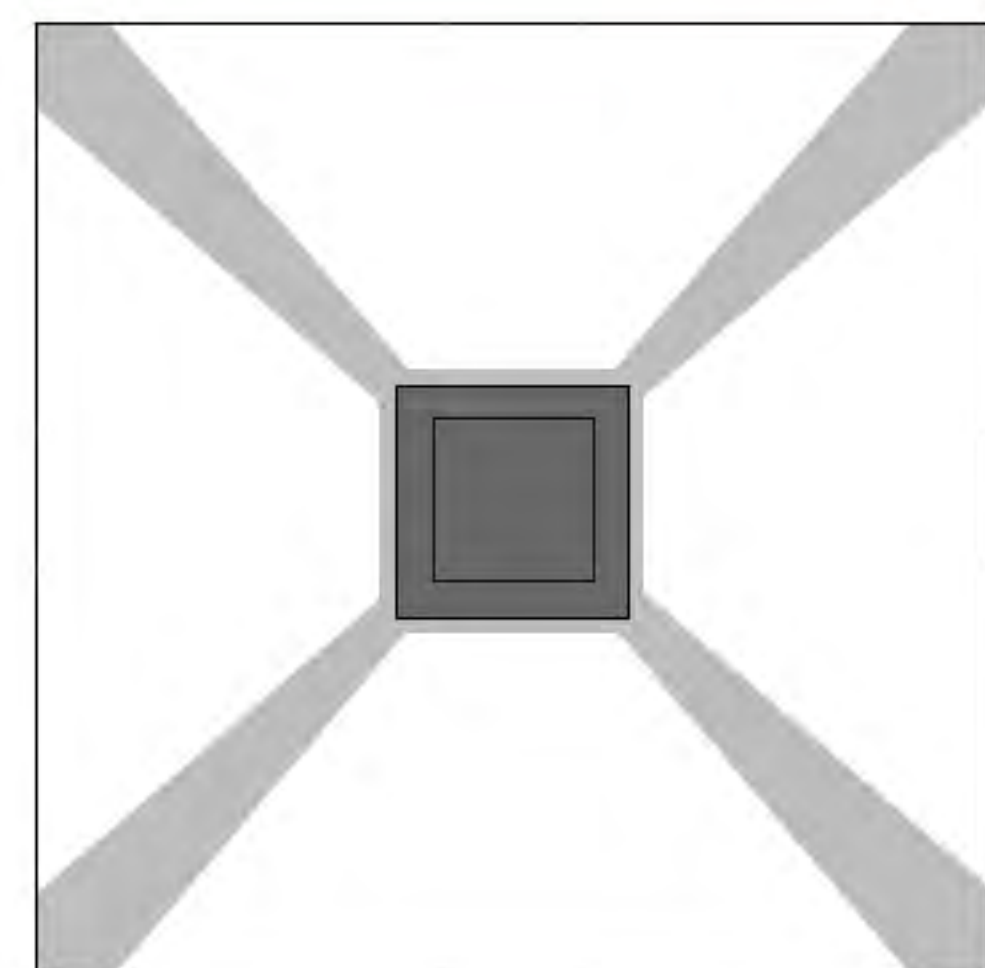

top view (俯视图)

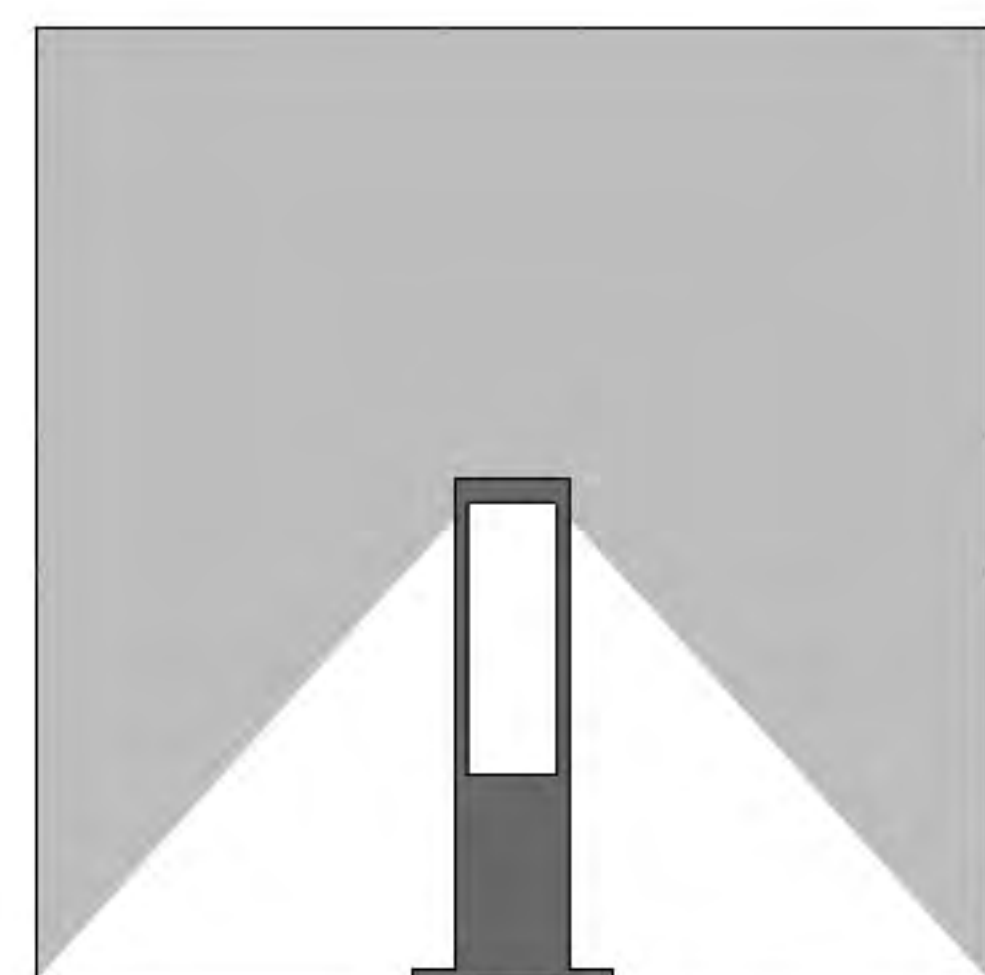

front view (正面图)



## Technical Date (技术参数)

Item No.	Lamp Type	Power	LM	CCT	PF	Voltage	CRI	A	B	C	D	E (mm)
MB-T016	LED	20W	1400	2700-6000K	0.9	AC110-265V	80-90	150	50	1450	1000	2500



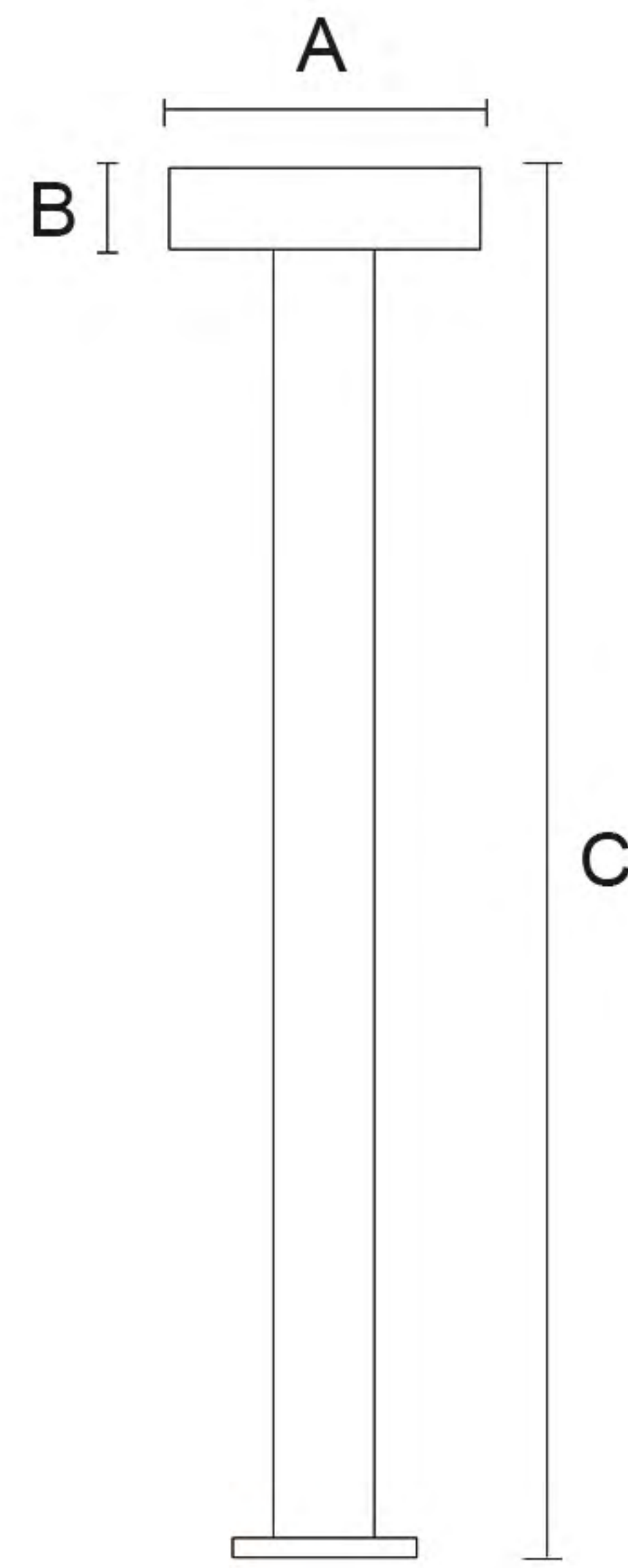

# MB-T017

## Features&Benefit (功能和优点)

Category (品类)	Garden Light
Diffuser Material (扩散器材质)	PC
Cover Material (面盖材质)	Aluminum
Operating mode (运行)	Built in
Steuerbar (开关)	On/Off
IP (防水等级)	54
Mounting type (安装类型)	Put
Mounting location (安装位置)	Overground
Application environment (应用环境)	Indoor/Outdoor
Body color (表面颜色)	Black/Dark Gray/Sliver Gray



## Product Description (产品描述)

They are suitable for outdoor lighting in city lanes, narrow lanes, residential neighborhoods, tourist attractions, parks, squares, private gardens courtyards corridors and other public places; the heights can be selected in many ways, which can satisfy different scenarios and desired effects. They create a pleasant atmosphere, add a sense of decoration to the scene and enhance its overall appearance.

## Lightmap (光影图)

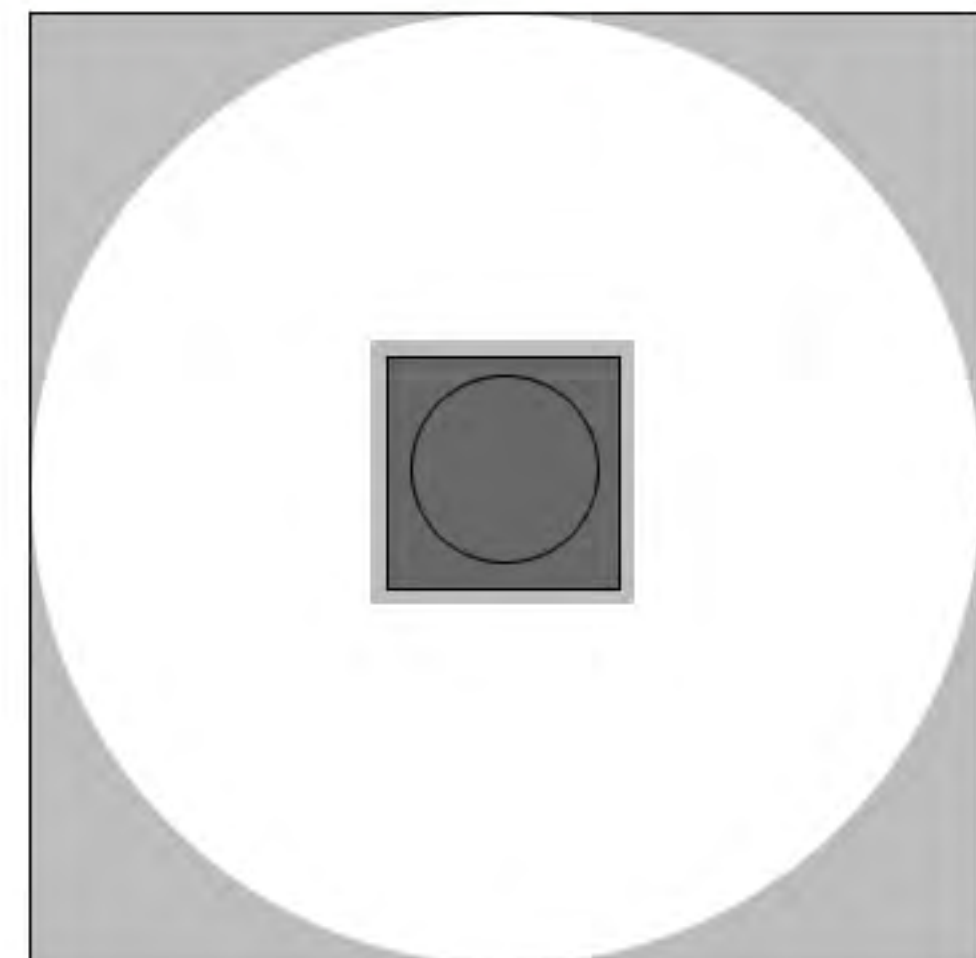

top view (俯视图)

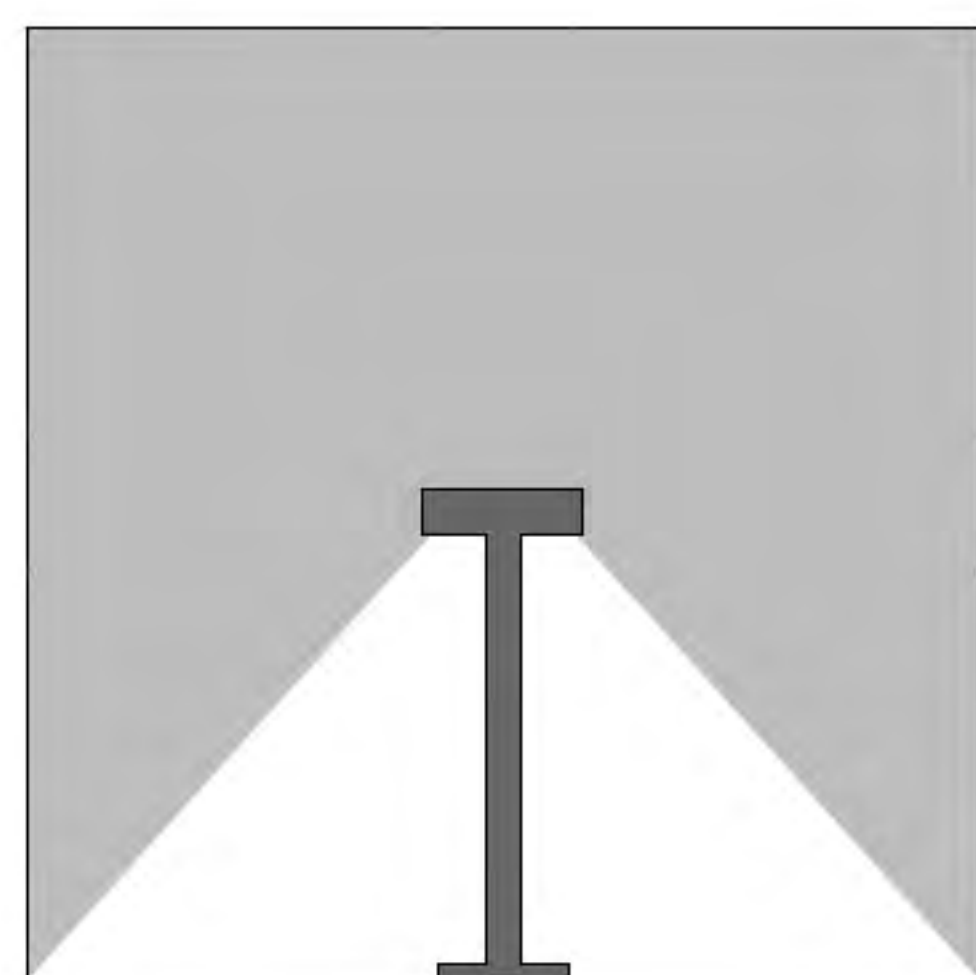

front view (正面图)



## Technical Date (技术参数)

Item No.	Lamp Type	Power	LM	CCT	PF	Voltage	CRI	A	B	C (mm)
MB-T017	LED	20W	1400	2700K-6000K	0.9	AC110-265V	80-90	Ø200	55	2500



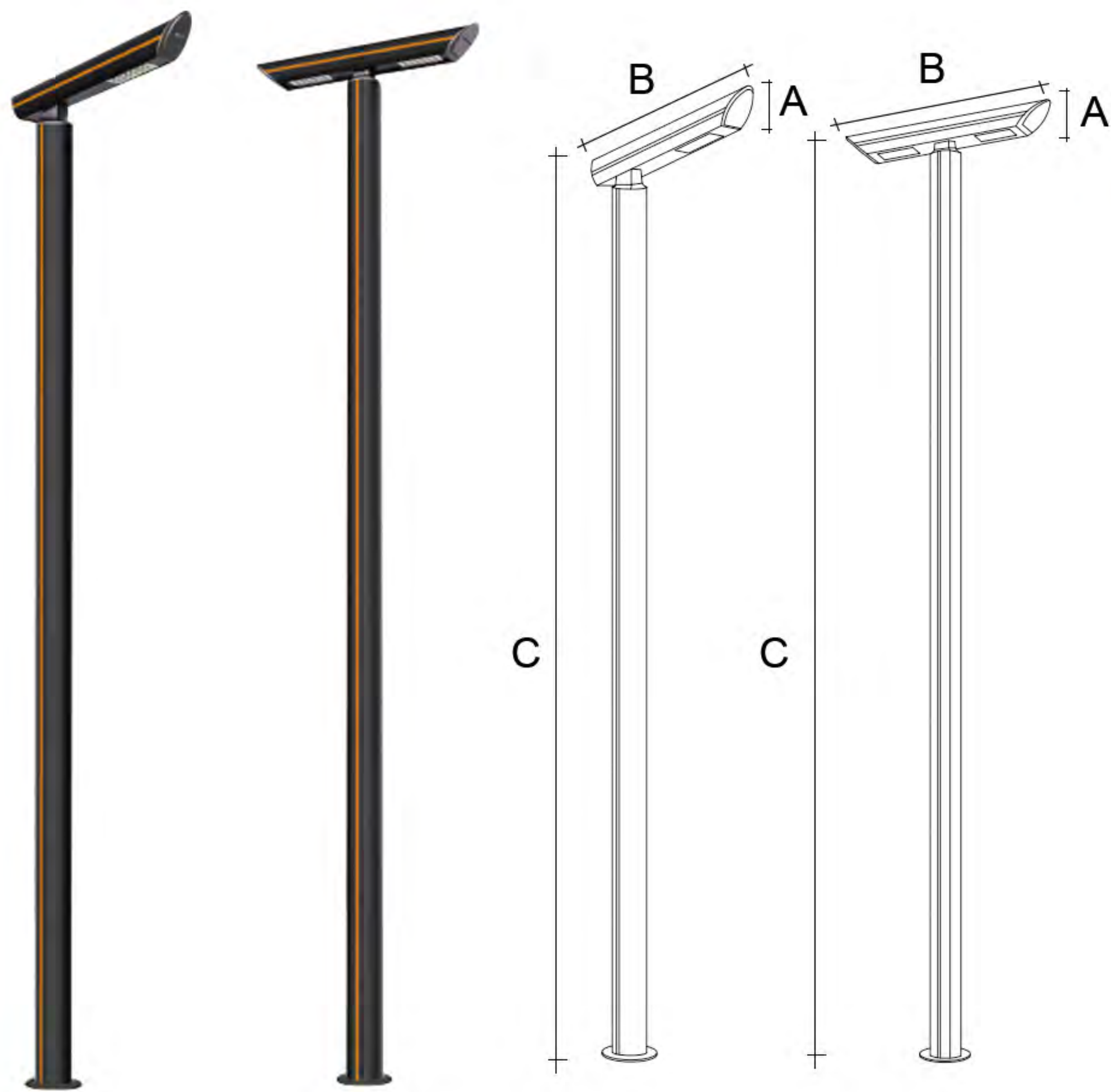

# MB-T018/MB-T019

## Features&Benefit (功能和优点)

Category (品类)	Garden Light
Diffuser Material (扩散器材质)	PC
Cover Material (面盖材质)	Aluminum
Operating made (运行)	Built in
Steuerbar (开关)	On/Off
IP (防水等级)	54
Mounting type (安装类型)	Put
Mounting location (安装位置)	Overground
Application environment (应用环境)	Indoor/Outdoor
Body color (表面颜色)	Black/Dark Gray/Sliver Gray



## Product Description (产品描述)

They are suitable for outdoor lighting in city lanes, narrow lanes, residential neighborhoods, tourist attractions, parks, squares, private gardens courtyards corridors and other public places; the heights can be selected in many ways, which can satisfy different scenarios and desired effects. They create a pleasant atmosphere, add a sense of decoration to the scene and enhance its overall appearance.

## Lightmap (光影图)



front view (正面图)



front view (正面图)

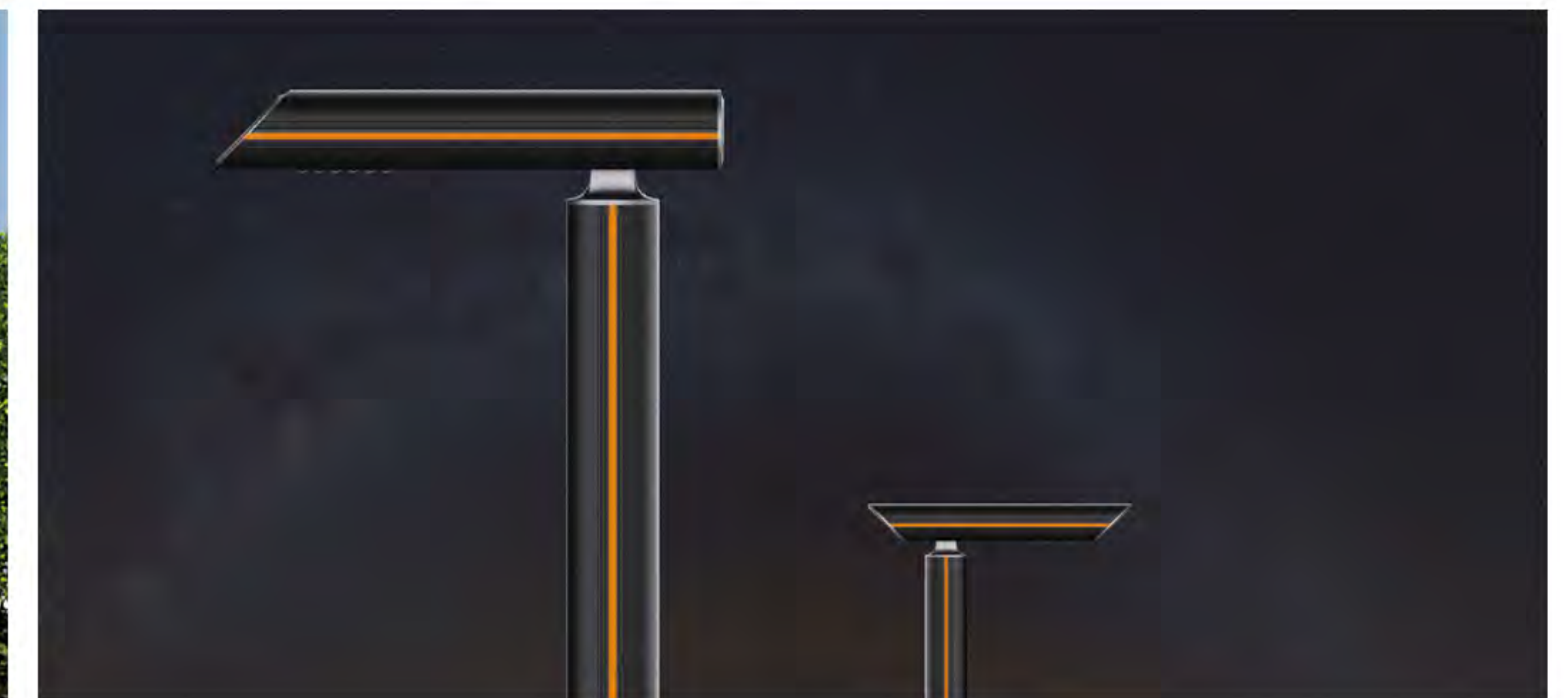

## Technical Date (技术参数)

Item No.	Lamp Type	Power	LM	CCT	PF	Voltage	CRI	A	B	C (mm)
MB-T018	LED	30W	2100	2700K-6000K	0.9	AC110-265V	80-90	Ø114	650	3000
MB-T019	LED	30W	2100	2700K-6000K	0.9	AC110-265V	80-90	Ø114	1186	3000





**MB LIGHTING**  
**TFB LIGHTING**

Guangzhou Huaen Lighting Co.,Ltd

TEL: +86-18665613129

Email: [info@china-customization.com](mailto:info@china-customization.com)

Website: <https://www.tfbcustomlighting.com>