

DNT[®]

Sourcing OEM Manufacturer

Automotive Tools Catalogue



Dongning Tools (Ningbo)Co.,Ltd

DNT[®]

Dongning Tools (Ningbo)Co.,Ltd

- 🇨🇳 DNT АВТО ИНСТРУМЕНТЫ
- 📞 +86-574-88298696/+86-574-87070383
- ✉ info@nbdntools.com
- 📍 No.6 Falan Rd, Hengjie town, Ningbo City, China

www.nbdntools.com





About us

Are you looking for sourcing tools manufacturer? Dongning Tools(Ningbo)Co.,Ltd(DNT Tools)is a reliable sourcing tool manufacturer from China, since 2000. Focus on product various of automotive tools, hand tools with high quality. All mechanics tools are made for automotive technicians at every skill level. OEM &Custom service is available. Welcome to contact us as soon as possible

coil spring compressor	P1
ball joint removal tool	P3
Brake caliper piston tool	P6
Wheel/Hub Puller Tools	P9
Pullers	P11
Nut Splitter	P13



CUSTOM

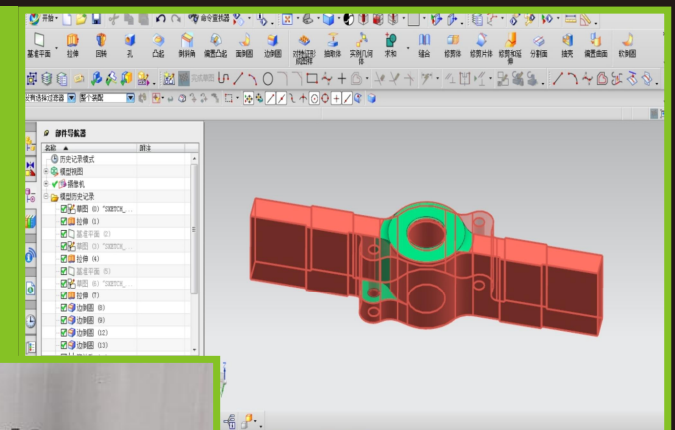
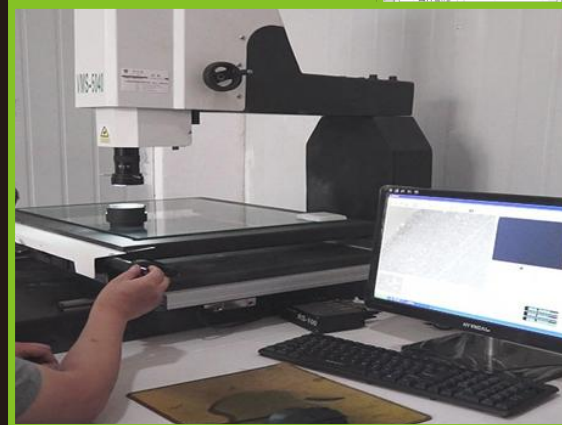

DN-B2002

**Shock spring compressor set
减震拆卸工具**

Suitable for MacPherson strut coil springs. Plastic yoke protectors that protect the spring coating from damage, which can invalidate the vehicle manufacturer's guarantee, if not fitted.

Safety yokes carefully shaped to stop the spring bowing while under compression.

Features a yoke extension bracket that also allows use on conical springs. Supplied with three pairs of different sized interchangeable yokes, for a wide range of vehicle applications.

Safety yokes are carefully shaped to stop the spring bowing while under compression.



Tips:
Compressor capacity.....2500kg
Max.jaw opening.....265mm
Drive.....21mm

How to use

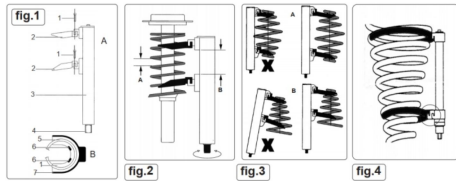

- 1 Retaining bolts
- 2 Yoke
- 3 Compressor body
- 4 Hex nut
- 5 Spring
- 6 Safety lips
- 7 Outer rib

DN-B2001



DN-B2003



Item No	compressor	Gold Yokes φ 80-105mm	Handed	Black Yokes φ 105-150mm	Handed	Silver Yokes φ 145-190mm	Handed
DN-B2001	yes	yes	N/A	yes	L/H	yes	L/H
DN-B2002	yes	yes	R/H	yes	R/H+L/H	yes	R/H+L/H
DN-B2003	No	No	N/A	yes	L/H	yes	L/H
DN-B1027	yes	yes	R/H	yes	R/H	yes	R/H

DN-B1028

**Coil Spring Compressor For Mercedes
奔驰专用弹簧压缩器**

Telescopic compressor for shock absorber springs. Suitable for removing and installing helicoil springs within multi-link, independent arm suspension systems-both front and rear. Supplied with two pairs of interchangeable caps provided with a three-hook safety system. φ70/130 suitable for Mercedes-Benz (124,202,210), SAAB, Ford, Skoda φ90/150 suitable for Mercedes-Benz (126,140)1100/200, OPEL, GM, LADA, PEUGEOT 405/605 ROVER, HYUNDAI, SAAB, VOLVO, VW, FIAT, MAZDA, TOYOTA, NISSAN, MITSUBISHI, Ford.



DN-B1027

**Mecpherson Spring Compressor
全车系弹簧压缩器**

Designed for work on Regular on macpherson strut assemblies use where space under wheel arch is limited.

Safety precaution: do not use the impact driver.
Use range: 80-115mm
Use range: 110-150mm
Use range: 140-195mm



DN-B1064

**Heavy Duty Strut Spring Compressor
强力型弹簧压缩器**

High capacity of max.Load:26000Nm. Max.working stroke:317mm. Suitable to work with air impact. Includes 3 pairs of c jaws for a wide of vehicle applications. Safety design of free turning since unacceptable overload. 3 pairs of yellow covers help protect lacquered springs surface from damage.



DN-B1067

**Universal Spring Compressor
弹簧压缩器**

Universal-Spring-Compressor with safety guard to remove coil springs quickly and safe Instructions for use: Hook the spring tensions into position on opposite side of the spring to cover as many turns as possible. Using a spanner or impact wrench, tighten the 19 mm spindle driver heads alternately. Install the new coil spring. Using the drive heads alternately, release the tension on the spring evenly. 1200Kg Maximum capacity per pair.



DN-B1033

**4Arms Coil Spring Compressor
双向四爪弹簧压缩器**

used in limited space under wheel arch and wrap coil claws for safty L=290mm



DN-B1033-A

**4Arms Coil Spring Compressor
单向四爪弹簧压缩器**

Designed for work on Regular on macpherson strut assemblies use where space under wheel arch is limited. L=390mm
Driver: 1/2 sq or 21mm



DN-B1047

**Coil Spring Compressor
通用型弹簧压缩器**

Suitable for small to medium sized vehicles. Two sliding hooks on carrier rail prevent slipping 24 mm spindle drive. Load capacity: 15,000 n (1,500 kg) Not suitable for impact wrenches Vpa / gs approved. Length: 300mm

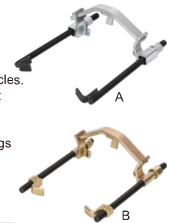

DN-B1055

**3pcs Coil Spring Compressor
3件弹簧压缩器**

Designed for using in limited space under wheel arch. Jaws design is fitting to wrap coil claws for safety. Length:310mm driver:24mm



DN-B1052

**MacPherson Strut Spring Hook Compressor
四方弹簧压缩器**

MacPherson Strut Spring Hook Compressor. These devices quickly and easily compress most sizes of MacPherson strut springs. Setup is fast and simple. Compression is achieved by alternating from one assembly to another. Each device has a heat-treated alloy thrust screw (5/8"-11 x 12") with forged hooks.



DN-B1005
Coil Spring Compressor
弹簧压缩器

Designed for using in limited space under wheel arch. Jaws design is fitting to wrap coil claws for safety.



Item No	Length	Driver
DN-B1005	255mm	1/2 SQ OR 21MM
DN-B1005-A	410mm	1/2 SQ OR 21MM
DN-B1006	355mm	1/2 SQ OR 21MM
DN-B1006-A	270mm	1/2 SQ OR 21MM

DN-B1008
Coil Spring Compressor
弹簧压缩器

Contains 2 spring compressors and 4 security hooks. Features double ended jaws with attachable security hooks for added safety and control. Operating capacity: 300mm. Overall length: 300mm. Suitable for passenger vehicles and light commercials. Driver: 24mm.



DN-B1021
Coil Spring Compressor
弹簧压缩器

Designed for using in limited space under wheel arch. Jaws design is fitting to wrap coil claws for safety. Driver 1/2 SQ OR 21mm Length: 280mm



DN-B1025
Strut Coil Spring Compressor
爪式弹簧压缩器

Hook engage spring which can be compressed by turning hex nut. Jaws capacity: 23-280mm Length: 280mm



DN-B1026
Coil Spring Compressor
单个弹簧压缩器

Heavy-duty Chrome Vanadium construction. Long-reach arms compress a higher proportion of the coil spring. Allows even and safe compression of spring prior to installation. Drive: 21mm Hex Maximum Jaw Opening: 310mm



DN-B1011
Universal Ball Joint Separator
欧式球头取出器

Special design 2-stage operation suits most cars and light trucks ball joints in steering & suspension. Tempered drop forged steel body and offset lever provide an excellent performance and long usage. Offset lever permits maximum fork opening in 56mm. Fork opening: 22mm.



DN-B1012
Ball Joint Separator
日式球头取出器

It works on most cars and light trucks. Heat treated drop forged steel body & bolt for long rough usage. Spread ball joints easily from the spindle support arm. Fork opening: 19mm.



DN-D1064
Ball Joint Separator
本田球头拆卸器

For splitting track-rod ends, anti-roll bar mountings, ball joints, etc. Opening: 17mm



DN-D1046
Ball Joint Separator
球头拔卸器

Manufactured from hardened steel with tough durable epoxy coating. The lever can be set to one of its four positions simply by releasing the pivoting pin. The tapered slim fork allows easy access. Suitable for use on most car and light commercial ball joints. Throat depth: 36mm.



DN-D1073
Universal Ball Joint Separator
可调式球头拔卸器

For splitting track-rod ends, anti-roll bar mountings, ball joints, etc.

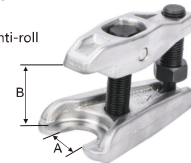

Item No	A	B
DN-D1073	22mm	62mm
DN-D1074	17mm	58mm

DN-B1037
Pitman Arm Puller
小龙门架球头拆卸器



This puller will handle nearly any Pitman arm job on passenger cars and light trucks. It features special forged jaws shaped to fit the job, ensuring a positive grip every time.

Item No	A	B
DN-B1037	27mm	45mm
DN-B1038	33mm	64mm

DN-B1038
Pitman Arm Puller
大龙门架球头拆卸器



DN-B1069
Ball Joint Separator
窄型球头拆卸器

Fits many domestic and imported front wheel drive vehicles. Removable pin fits into two pivot points for versatility. The mini operation space: 6-7mm. With safety rope to avoid drop while operating.



Item No	Opening
DN-B1069	19mm
DN-B1070	28mm

DN-D1065
Ball Joint Separator
球头拆卸器

For splitting track-rod ends, anti-roll bar mountings, ball joints, etc. opening: 17mm



DN-D1109
Ball Joint Extractor 25mm
卡车球头拆卸器

Special designed to remove the truck ball joint Suitable for light trucks and SUV Jaw opening: 25 mm



DN-B1049
Ball Joint Separator
立式球头

Forged steel body with steel thrust bolt. Suitable for most cars and light vans. Jaw Capacity: 17mm



DN-B1045

7" Outer Tie Rod Puller
两爪活动球头 (大)

This tool is a must when you're servicing outer tie rods and ball joints. It works on imported and domestic models, front or rear wheel drive, cast or stamped-steel steering knuckles. Handles up to 5 tons of force. Jaws spread to 3" and has a 4" reach. Jaws, once tightened, won't slip on the knuckle.



DN-B1029
Multi-Purpose Inner Tie Rod Tool
方向机扳手 (大)



DN-B1030
Multi-Purpose Inner Tie Rod Tool
方向机扳手 (小)



This tool allows quick and easy replacement of the inner track rod joint. Removal of the steering gear is not necessary.

Item No	Size
DN-B1029	Φ33~42mm
DN-B1030	Φ27~42mm
DN-B1071	Φ42~50mm

DN-B1032
5pcs Ball Joint Separator Set
5件球头组套

Kit includes five popular tools used for servicing pitman arms, ball joints, and tie rods on most vehicles.

Set includes:
DN-B1038 – Pitman arm puller.
DN-B1049 – Tie rod end remover.
DN-B1045 – Outer tie rod remover.
DN-B1037 – Tie rod end puller.
DN-B1011 – Ball joint separator.



DN-D1088
Hydraulic Ball Joint Splitter
小型液压欧式球头

Suitable for light commercial vehicles. Specially designed to be operated manually or by 1.5 tonne hydraulic ram supplied. Features a step down thread adaptor that allows fitting of the manual thrust screw. Opening: 22mm



DN-D1011
5Pcs Ball Joint Separator
5件叉式球头拆卸器

Use to separate ball joints, tie rods, and Pitman arms.
 Set contains two handles:
 Knurled handle allows use of a hammer. Smooth handle fits in a pneumatic hammer. Three sizes of pickle forks included: 1-1/8", 15/16", and 11/16".
 Set contains:
 DN-D1011-1 Fork heads (set of three: 11/16", 15/16", and 1-1/8"). DN-D1011-2 Handles (set of two: knurled handle for use with a hammer, smooth handle for use with an air hammer).



DN-B1031
Ball Joint Separator Set
3件球头撬杆

Features three popular "pickle forks" in a blow-molded case. Used to remove shock linkage, tie rods, and ball joints. Also for general service on many cars and light trucks.
 Includes:
 DN-B1031-1 - Size 300mm*22mm Fork Spread.
 DN-B1031-2 - Size 300mm*27mm Fork Spread.
 DN-B1031-3 - Size 400mm*16.5mm Fork Spread.



DN-D1032
Large Ball Joint Separator
大型球头拔套

Large ball joint separator is designed for use on all cars and light trucks that have press-fit type ball joints.
 For extracting work pieces without bore. Valuable accessory for common press and pull sleeve sets.
 Open c-shaped construction allows more flexible operation directly on vehicle compared to conventional press frames.
 Magnetic holders on thrust plates for convenient working.
 With impact quality M18 vibration spindle. The momentum produced by impact wrench acts like hammer strokes on the work piece, thus causing tight connections to break open can be converted for use with hydraulic spindle (un1.1/2"x16 thread, 9" opening).



DN-D1061
Hydraulic Ball Joint Separator
液压重型球头组

Heavy-duty ball joint splitter suitable for HGV vehicles.
 Specially designed to be operated manually or by 10 tonne hydraulic ram supplied.
 Features a step down thread adaptor that allows fitting of the manual thrust screw or hydraulic ram.
 Jaw Capacity: 35mm
 Jaw Opening Capacity: 100mm



DN-B1036
3pcs Ball Joint Removal Tool
3件球头拆卸器

Low profile with three sizes of jaw, allows use on most modern cars and light commercial vehicles. Features heavy-duty forged steel body and hardened screw with thrust ball. Supplied in carry-case.
 Suitable for Audi, BMW, Ford, Chrysler, Opel, SAAB, Volvo, VW, NISSAN, TOYOTA.
 Fork opening: A: 23mm, B:55mm
 A: 28mm, B:55mm
 A: 34mm, B:63mm



DN-B1041
4wd Ball Joint Remover Kit(4 In 1)
10件球头连接拆装组 (4合1)

This starter kit is the backbone to ball joint, U-joint, anchor pins, and many other general pressing operations.
 Kit includes 5 adapters and C-Frame provided in a case.



DN-B1042
4WD Ball Joint Remover Kit(3 In 1)
球头连接拆装组 (3合1)

This starter kit is the backbone to ball joint, U-joint, anchor pins, and many other general pressing operations.
 Kit includes 3 adapters and C-Frame provided in a case.



DN-B1060
Master Ball Joint Super Set
21件球头拆卸器

Master ball joint super set allows for the removal and installation of press-fit ball joints on many GM and Ford light-duty trucks, vans and SUVs through 2003; Dodge light trucks through 1998; Dodge vans, Durango and Dakota through 2003; and Honda Accord, Civic, del Sol, and Prelude through 2001.
 The C-frame tool can be used alone to remove and universal joints.
 Comes complete with an application cross reference and instructions in a blow-molded case.



DN-B1061
Ball Joint Tool Adapter Set
14件球头取出器

This adapter set includes receiver tubes and adapters for most GM, Ford, Dodge two-wheel drive, four-wheel drive pick-ups, vans and SUVs for ball joint replacement and ball joint repair! Constructed of forged carbon steel and a black oxide finish for toughness and durability, this ball joint set is designed to handle worksite abuse. The ball joint adaptor set comes in a sturdy storage case for organization and transport. Includes receiver tubes and adapters. Forged, heat treated and machined carbon steel. Black oxide finish.



DN-B1063
Ball Joint Remover For Mercedes Benz
奔驰球头取出器

Ball Joint Installer and Remover Set - Mercedes-Benz
 This tool removes and installs the lower ball joints whilst insitu without removing parts. used for Mercedes-Benz (W220/W211/W230).



DN-D1055
Quick-Change Ball joint Remover
可拆装球头拆卸器组套

Innovative quick change and simple action for suitable fork. Enable operator to select correct jaw size without taking entire extractor to the vehicle. Adjustable opening angle.
 Fork opening: 20,22,24,27,30mm
 Thrust screw: 100mm(L)
 Pivot rod: 125mm(L)



DN-B1044
Brake Spring Compressor
刹车弹簧压缩器

Removes and installs brake spring washers from 5/8" to 7/8" in diameter. Brake Spring Compressor Tool Provides leverage to remove and install stubborn hold down springs of drum brakes on cars and light trucks.
 Special beveled cup end and notched design grips the retaining washers (5/8" to 7/8") used to hold the springs in place. Comfortable handle and knurled base for solid gripping.



DN-B1018
Brake Piston Spreader Tool
鸭嘴式刹车分泵

ensures parallel piston retraction avoiding damage to the piston seals. For use on opposed fixed and single piston sliding calipers. Maximum Spread: 90mm



DN-B1034
Disc Brake Piston Spreader
碟式刹车分泵

This disc brake piston spreader has been designed for quad pistons fitted to BMW, Mercedes-Benz and other vehicles. Maximum working range 88mm
 • Suitable for use on quad pistons.
 • Applications include Mercedes-Benz & BMW etc.
 • Maximum working range 88mm.
 • Manufactured from selected steel.
 • Time saver.



DN-B1017
Brake Piston Wind Back Tool
筒式刹车风泵

Double end tool. Enables retraction of the piston on rear brake callipers allowing new brake pads to be installed.
 Pin Diameter: 6mm
 Distance Between Pin Centres: 22, 33mm



DN-B1019
Brake Piston Spreader
碟式刹车分泵

Chemically blackened steel spreader plates. An essential tool for retracting the brake piston to allow insertion of new brake pads. Suitable for most ATE, Bendix, Delco and Girling callipers.
 Maximum Spread: 70mm



DN-B1016
35pcs Brake Caliper Wind Back Tool
35件刹车分泵调整组

For rotating pistons back into caliper to provide clearance for new pads
 Prevents damage to the piston and boot
 Suitable for Bmw, Ford, Vw, Audi, Porsche, Saab, Opel, Volvo, Jaguar, Citroen, Peugeot, Renault, Lauxhall, Lancia, Alfa romeo, Fiat, Nissan, Honda, Subaru, Toyota, Mitsubishi



DN-B1040
37pcs Brake Caliper Wind Back Tool
37件刹车分泵调整组

For rotating pistons back into caliper to provide clearance for new pads
 Prevents damage to the piston and boot
 Suitable for Bmw, Ford, Vw, Audi, Porsche, Saab, Opel, Volvo, Jaguar, Citroen, Peugeot, Renault, Lauxhall, Lancia, Alfa romeo, Fiat, Nissan, Honda, Subaru, Toyota, Mitsubishi



DN-B1010

12pcs Brake Caliper Wind Back Tool 12件刹车分泵调整组

12 Piece Set With 10 Interchangeable Heads That Offer A Large Coverage Of Disc Brake Calipers Fitted To Today's Modern Vehicles. Kit Includes Both Left And Right Hand Piston Retracting Forcing Screws. For Use On The Following Vehicles: Mercedes, Bmw, Vw, Gm, Audi, Ford, Honda, Subaru, Mazda, Nissan, Mitsubishi, Toyota, Rover, 4wd, Etc. Universal Applications.



DN-B1009

18pcs Brake Caliper Wind Back Tool 18件刹车分泵调整组

Includes left- and right-handed thrust bolt assemblies.
Applications: Alfa Romeo, Audi, BMW, Citroen, Fiat, Ford, GM, Honda, Jaguar, Mazda, Mercedes, Mitsubishi, Nissan, Opel, Peugeot, Renault, Rover, Saab, Seat, Skoda, Subaru, Toyota, Vauxhall, Volkswagen, Volvo.



DN-B1072

40pc Brake Piston Caliper Tool Kit 40件刹车分泵调整组

comprehensive kit designed to allow quick and efficient brake servicing for most vehicles. The kit is supplied with left handed and right handed winders for returning the brake piston into the caliper and providing clearance for new brake pads. The kit includes pin punches, brake keys, pentagon bit and sockets



DN-B1010

12pcs Brake Caliper Wind Back Tool 12件刹车分泵调整组

12 Piece Set With 10 Interchangeable Heads That Offer A Large Coverage Of Disc Brake Calipers Fitted To Today's Modern Vehicles. Kit Includes Both Left And Right Hand Piston Retracting Forcing Screws. For Use On The Following Vehicles: Mercedes, Bmw, Vw, Gm, Audi, Ford, Honda, Subaru, Mazda, Nissan, Mitsubishi, Toyota, Rover, 4wd, Etc. Universal Applications.



DN-B1014-C

12pcs Brake Caliper Wind Back Tool 12件刹车分泵调整组

Alloy steel, hardened & phosphate zinc finished contents;
1-Rotating caliper(right hand helix bolt)
11-Disc brake pad, Suitable models: Mercedes benz, BMW, OPEL, FORD, NISSAN(CEFIRO), TOYATA, GM.



DN-B1013

21pcs Brake Caliper Wind Back Tool 21件刹车分泵调整组

21 Piece set with 17 interchangeable heads that offer a large coverage of disc brake calipers fitted to today's modern vehicles.
Kit includes both left and right hand piston retracting forcing screws. For use on the following vehicles: Mercedes, BMW, VW, GM, Audi, Ford, Honda, Subaru, Mazda, Nissan, Mitsubishi, Toyota, Rover, 4WD, etc. Universal applications.

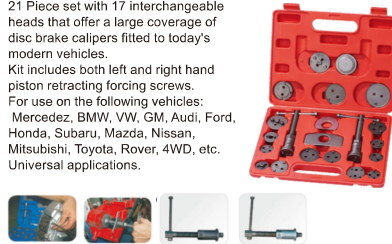

DN-B1073

21pc Air Brake Piston Caliper Tools 21件气动刹车分泵调整组

Winds back brake caliper pistons to replace brake pads
Fits most European & Japanese cars
Magnetic pads hold adaptors in place
Tool for both left & right handed threaded pistons
Set includes 20 popular adaptors



DN-B1078

27pc Disc Brake Caliper Tool Kit 27件刹车分泵调整组

Most comprehensive disc brake caliper wind back kit with 22 interchangeable heads. Some heads are double sided and both left and right hand piston retracting tools are included. Universal applications For use on: Mercedes, BMW, VW, GM, Audi, Ford, Honda, Subaru, Mazda, Nissan, Mitsubishi, Toyota, Rover, 4WD, Renault, Astra, Volvo, Alfa Romeo, Jaguar, Opel, Fiat, Peugeot, etc.

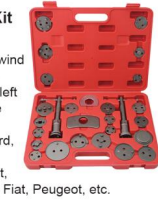

DN-B1014

13pcs Brake Caliper Wind Back Tool 13件刹车分泵调整组

13 pcs basic set for setting back brake pistons
- right threaded wind back tool
- suitable for many car models
- includes list of matching car models Services: Mercedes, BMW, VW, GM, Audi, Ford, Honda, Subaru, Mazda, Nissan, Mitsubishi, Toyota, Renault & Opel



DN-B1015

35pcs Brake Caliper Wind Back Tool 35件刹车分泵调整组

For rotating pistons back into caliper to provide clearance for new pads
Prevents damage to the piston and boot
Suitable for Bmw, Ford, Vw, Audi, Porsche, Saab, Opel, Volvo, Jaguar, Citroen, Peugeot, Renault, Lauxhall, Lancia, Alfa romeo, Fiat, Nissan, Honda, Subaru, Toyota, Mitsubishi



DN-B1074

18pc Air Brake Piston Caliper Tools 18件气动刹车分泵调整组

Winds back brake caliper pistons to replace brake pads
Fits most European & Japanese cars
Magnetic pads hold adaptors in place
Tool for both left & right handed threaded pistons
Set includes 17 popular adaptors



DN-B1080

13pc Disc Brake Caliper Tool Set 13件刹车分泵调整组 (新款)

For Rotating Pistons Back into the Caliper and to Provide Clearance for New Pads
Durable and Easy Use for Professionals and Serious DIY Users
Application for Most of Both Imported and Domestic Major Cars
Helps Prevent damage to the piston and boot



DN-B1039

15pcs Brake Caliper Wind Back Tool 15件刹车分泵调整组

This tool set is used to install new brake pads by winding the piston back into the caliper through the convenient T-bar rotation. Piston retraction is smoothly completed without damaging the piston or boot. Its 13 adaptors can be used on both 2 and 4 wheel



DN-B1076

Brake Caliper Rewind Tool Kit - Adjustable 刹车分泵调整组

For rewinding the brake piston back into the caliper
Adjustable adaptor fits most of vehicles
Innovative left and right screw thread that increases the number of vehicles
Pins will take up to 50Nm torque.
Replacement pins



DN-B1075

16pc Air Brake Piston Caliper Tools 16件气动刹车分泵调整组

Winds back brake caliper pistons to replace brake pads
Fits most European & Japanese cars
Magnetic pads hold adaptors in place
Tool for both left & right handed threaded pistons
Set includes 15 popular adaptors



DN-A1159

15pc Brake Maintenance and Assembly Tool Set 15件刹车维修工具组套

all purpose set for drum and disc brake systems
- includes following tools:
- brake spring pliers with movable claw for removing and installing of brake shoe springs
- brake spring pliers for installing and removing the brake shoe recuperating spring on riveted brake linings
- brake caliper brush for removal of brake dust and dirt from the brake caliper
- brass brake caliper brush for cleaning aluminium brake calipers
soft brass bristles facilitate damage-free cleaning
- special tool for brakes for installing and removing spring plates and the holding device of brake linings on drum brakes, e.g. on VW, Seat, Skoda, Opel and Renault with rear drum brakes
- brake caliper file, extra slim style (width 10 mm), especially appropriate for Japanese vehicles, for removal of brake dust, rust and dirt from the brake caliper
- brake line flare nut wrench for screwed connections on brake lines at the front and rear axle, Straight slot with 10x11 6-point
- assembly tool for installing and removing the draw spring of hand brake shoes, e.g. on MERCEDES-BENZ passenger cars with rear disc brakes as well as on VW LT since 1997
- brake spring installer for pressure spring of the parking brake
- brake cable pliers for removing and replacing the hand brake cable, the pliers compress the return springs so far that the cable may be easily removed and replaced.



DN-D1024**24pcs Pull And Press Sleeve Kit
24件铁套拆装工具**

Universal tool kit for extracting and drawing in silent bearings, hydraulic bearing, bearing bushes, ball bearings, shaft seals, rubber bearings, etc.
Fully universal application, ideal for different vehicles, Car+HGVs, Depending on requirements, the particular sleeves can also be individually reworked.
Application also with workshop press+press frame.
20pcs press-on sleeves.
Inside:Φ34,36,38,40,42,44,46,48,50,52,54,56,58,60,62,64,66,68,70,72mm
Outside:Φ44,46,48,50,52,54,56,58,60,62,64,66,68,70,72,74,76,78,80,82mm
4pcs pulling spindle+nuts, size:M10,M12,M14,M16

**DN-D1025****27pcs Pull And Press Sleeve Kit
27件铁套拆装工具**

Universal tool kit for extracting and drawing in silent bearings, hydraulic bearing, bearing bushes, ball bearings, shaft seals, rubber bearings, etc.
Fully universal application, ideal for different vehicles, Car+HGVs, Depending on requirements, the particular sleeves can also be individually reworked.
Application also with workshop press+press frame.
20pcs press-on sleeves.
Inside:Φ34,36,38,40,42,44,46,48,50,52,54,56,58,60,62,64,66,68,70,72mm,75mm,80mm
Outside:Φ44,46,48,50,52,54,56,58,60,62,64,66,68,70,72,74,76,78,80,82mm,85mm,90mm
4pcs pulling spindle+nuts, size:M10,M12,M14,M16,M18

**DN-D1095****Master Press And Pull Sleeve Kit
分体式铁套拆装工具**

Universal applications - Car - LCV
Contains 20x Press Sleeves in 2mm diameter steps
Inside Diameter Range: 34 - 72mm
Outside Diameter Range: 44 - 82mm
4x Step Plates / 4x Pulling Spindles with thrust bearings.
Supplied in mould storage case

**DN-D1117****Master Press And Pull Sleeve Kit
分体式铁套拆装工具**

Universal application of step disc fits many kinds of different vehicles Easy work to remove and install for Bearing, bush, silent bearing, hydraulic bearing, rubber bearing
Sleeves are 3 1/2" in height
11pcs (Gold):D44XD34, D46XD36, D54XD44, D56XD46, D58XD48, D66XD56, D68XD46, D58XD48, D66XD56, D68XD58, D70XD60, D78XD68, D80XD70, D82XD72
9 pcs (Silver):D48XD38, D40D30, D52XD42, D60XD50, D62XD52, D72XD62, D74XD64, D76XD66

**DN-D1021****19pcs Fwd Wheel Bearing Tool Kit
19件仰角培林拆装组**

Up-to-date kit for the installation and removal of front hub bearings without the need to dismantle the steering knuckle and strut assembly.
Fast and simple to use.
Suitable for most front wheel drive cars.
Heavy-duty steel drifts with black phosphate finish for corrosion resistance.
May be used with impact wrench.
Supplied in carry case.

**DN-D1023****23Pcs Fwd Front Wheel Bearing Tool Kit
23件仰角培林拆装工具**

A great tool used to replace front wheel bearings without removing the steering knuckle & strut assembly.
AS the spindle assemble without removed there is no need to align front end after the job is done.
Fit on most cars.
Could be worked with shop press also.

**DN-D1062****52pcs Bearing Removal Tool Set
52件铁套培林拆装组**

This master set allows you to build your own custom bushing driver.
Select the required sizes and assemble your driver tool.
Build to suit the required seal, bush or bearing job.
Disc size:18mm through to 65mm in 1mm increments and 74mm.

**DN-D1063****Extra Large Bearing Removal Tool
特大铁套培林拆装组**

This extra large driver set allows you to build your own custom bushing driver. Select the required sizes and assemble your driver tool.
Discs are connected with a shaft and screw which connects to the driver handle.
Build to suit the required seal bush or bearing job. Discs size:70mm through to 150mm in 5mm increments.

**DN-D1113****Rear Axle Bearing Puller Set
后桥轴承拉拔器**

Pullers: 1" to 1-7/8", 1-5/16 to 2-3/8", 1-3/8" to 2-7/8"
Pulling Tools to Quickly Remove Semi-Floating Rear Axle Bearing Washer Captures the Bearing Firmly
Use Slide Hammer with 5/8"- 18 UNF Thread

**DN-D1087****Hydraulic Hub Puller Set
液压轮毂拆装工具**

Chromed, heat treated SAE1045 steel puller yoke with hydraulic ram.
Suitable for four and five stud hubs.
Hydraulic ram provides additional power to extract the most stubborn hubs. Supplied in storage case.

**DN-D1096****Two Way Hydraulic Gear Puller
五爪油压轴拔卸器**

Capacity:12tons.
Special safety device design to ensure worker operation.

**DN-D1105****Universal Wheel Hub Puller Set
三爪轮毂拔卸器**

Readily adjustable sliding legs to pull wheel hubs more quicker & easier where the bolt circle does not exceed 7-1/2" (190,2mm) also removes press-fit rear break drums.
Striking handle & puller screw included.
Special designed to use on most models of car.
Provides a straight pull. Will not distort wheel lugs.
Striking wrench and puller screw included

**DN-D1128****Hydraulic Wheel Hub Puller with Hammer Set 10 Ton
轮毂拆卸工具**

Included 3 pullers/ hammers: hydraulic spindle, screw, impact hammer
It is suitable for almost all 3 . 4 . 5 and 6 holed hubs.
Used to press the axle shaft from the hub
For four or five bolt hubs with the centerline of the bolts mounted in a 4.57"-5.31" diameter circle
Hydraulic spindle with 10 ton capacity
Suitable for GM . VAG . Peugeot . Citroen . Renault . Ford and Volvo etc.
Highest quality design for long life in daily workshop use

**DN-D1051****9-Way Slide Hammer Puller Set
通用型滑槌组套**

Pulls flange-type rear axles and most front-wheel drive hubs.
Internal and external jaws provide a variety of combinations to pull bearings, gears and seals.
Two- and three-way cross blocks and cone provide the perfect jaw configuration for most jobs.
Set also includes a grip wrench adapter and a dent puller attachment for sheet metal or other unique pulling requirements.
puller type: Twin leg
Internal capacity: 35-110mm Reach: 82mm
External capacity: 50-140mm Reach: 75mm
Puller Type: Triple leg
Internal capacity: 50-135mm Reach: 82mm
External capacity: 20-135mm reach: 75mm

**DN-D1142****Wheel Hub Puller
液压轮毂拆卸工具**

Hydraulic Wheel Hub Puller
Hydraulic Ram with 10 Ton capacity used to press the axle shaft from the hub.
For 4 or 5 bolt hubs with a 96 - 125mm diameter circle.
Applicable to most vehicles

**DN-D1112****Wheel Hub Pullers
手动轮毂拆卸工具**

For cars and goods vehicles with wheel stud circles up to 250 mm.
Simple use. Just place the plate with the spindle on the centre marking of the axle and fold back the hooks onto the plate.
With swivelling nut holders always lying flat on the hub to prevent wheel stud damage.

**DN-D1112-A****Wheel Hub Pullers
手动/液压轮毂拆卸工具**

For wheel stud circles up to 250 mm
With wheel stud protection using rotating nut apertures that always lie flat to the hub for ø 22 mm and suitable reduction bushing ø 14 and 18 mm
Easy to use
Upgradeable with hydraulic



DN-D1083**Wheel Hub Bearing Tool For Vw 85mm
轮毂拆卸工具**

Compact Wheel Bearing Set for Audi / VW
For removing and installing the compact wheel bearing / combined wheel hub and bearing unit on VW Polo Fox etc.
High strength spindle and components suitable for direct use on vehicle while in-situ.

**DN-D1094****Wheel Hub Bearing Tool For Vw 82mm
轮毂拆卸工具**

For GEN2 wheel bearings on Ford | Land Rover | Volvo vehicles

**DN-D1093****Wheel Hub Bearing Tool For Vw 78mm
轮毂拆卸工具**

Front Wheel Hub Bearing Unit Tool - 78mm on Ford | Mazda | Volvo
With Pressure plate and bolts
Disassembly shells and pressure piece
Mounting shells and pressure piece
High strength ball bearing spindle.

**DN-D1089****13pcs Slide Hammer Body Repair Set
大型钣金滑锤组**

Ideal For Auto Body Repair
Slide Weight: 10LBS
Slide Pole Length: 22-3/4"
Slide Pole Diameter: 3/4"
Attachments: 1 Handle, Washer, 5pc Hasp Iron, Long Tube Hasp Iron, Cast Iron Hammer, Right Angle Flat Steel, Hex Taping Adaptor, Hex Taping Screw Holder, Taping Screw, Connector Hasp Iron, Double Barreled Connector

**DN-D1118****40pc Diesel Injector Extractor Slide Hammer Set
40件滑锤拉马组套**

This professional tool is a specialised sliding hammer for removal of stuck and seized common rail injectors without dismantling the cylinder head for all injection nozzle cars.
The robust construction enables rapid withdrawal, even the most severely seized injector will come out with little fuss.

The kit comes with adapters, 3.9kg weight, handle and injector extractors. Ideal for the professional mechanic or enthusiastic DIY'er. Made by professionals for professionals.

**DN-D1130****VAG Wheel Hub Bearing Tool 66mm
轮毂拆卸工具**

VAG Wheel Hub Bearing Unit Tool - 66mm
For removing and installing the compact wheel bearing combined wheel hub and bearing unit on VAG vehicles.
High strength ball bearing fitted spindle.
Applicable to VAG vehicles

**DN-D1084****Wheel Hub Bearing Tool For Vw 62mm
轮毂拆卸工具**

VAG Wheel Hub Bearing Tool Set - 62mm
For combined wheel hub and bearing units.
Suitable for direct use on vehicle while in-situ.
Mounting shells and Dismantling shells
Mounting and Dismantling plates
Pressure plate with 8 holes

**DN-D1092****Wheel Hub Bearing Tool For 72mm Vag
轮毂拆卸工具**

VAG Compact Wheel Bearing Set
For removing and installing the compact wheel bearing combined wheel hub and bearing unit on VW vehicles with high strength spindle and components

**DN-D1081****14pcs Diesel Injector Puller Set
滑锤仰角套筒组**

Suitable for the fast and safe removal of Bosch, Delphi, Denso and Siemens diesel injectors. Set includes keys and deep open profile sockets, used to dismantle injectors, plus adaptors for attaching the slide hammer securely to the body of the injector. Ball joint allows hammer to be used in confined areas. Contents: Slide Hammer, 1/2" Sq Drive Sockets; 25, 27, 29, 30mm, Tamper-Proof Key, 5 x Adaptor (Bosch, Delphi, Denso, Siemens), Ball Joint

**DN-D1086****3pcs Diesel injector puller
3件柴油喷嘴拉马**

Use to remove stubborn diesel injector. No need to remove cam cover and the use of slide hammer.
For Mercedes C-class, E-class, Sprinter Vehicles and Chrysler Grand Cherokee 27crd(00-)

**DN-D1049****VW Bush Tool (polo)
VW 三脚架铁套拆装器**

Removal and replacement of the silent bloc placed in dir bracket is easily and safely carried out directly on the vehicle by using the extractor.

**DN-D1099****Thin Type Two Jaws Bearing Remover
齿轮盘拆卸器**

Removes objects (bearing, etc) in narrow place. Thin type 2 jaw gear puller (range: 40 - 90mm) that can be used for many applications.
Removes objects (bearing, etc) in narrow place.

**DN-D1006****15pcs Harmonic Balancer And Puller Tool
15件方向盘拉拔器**

Versatile puller capable of removing a wide variety of components having tapped pulling holes such as gears, pulleys, etc.
Includes: yoke 5/8-18" L 127mm, thrust bolt, centring Adaptors; Small, Large, Flat, Bolts; 1PC 5/8-18; 2pcs 3/8-16; 3pcs 3/8-24; 2pcs M8*1.25"; 3pcs 5/16-18; 1PC flat head; 1PC Pointed head

**DN-A1125****Changeable Two Jaws Pulley Remover
两爪更换型皮带盘拆卸器**

Suitable for using when the space limited.
To change the parts easily for fitting the different cars.
Jaw length: 72/95MM.
Jaw depth: 18mm, with: 4.4mm

**DN-D1078****8pcs Steering Wheel Puller Set
8件方向盘拆装工具**

Two-leg puller, with two pairs of legs and two thrust caps.
For use on GM (Vauxhall/Opel) and Ford vehicles.
long puller arm length: 135mm
Short puller arm length: 87mm

**DN-D1026****Battery Terminal & Wiper Arm Puller
雨刮器拆卸器**

Heavy-duty construction with locking feature allowing the tool to be fastened securely to the wiper arm before commencing pull.
Combination of swivel mounted thrust bearing and tommy bar on thrust bolt allow even the most stubborn wiper arms to be lifted off their drives. Suitable also for battery terminal and alternator bearing removal.
Maximum Opening: 28mm
Maximum Collar Size: 43mm.

**DN-D1008****46pcs Harmonic Balancer And Puller Tool
46件方向盘/齿轮拉拔器**

Versatile puller capable of removing a wide variety of components having tapped pulling holes such as gears, pulleys, etc. includes: Yoke, 130mm Thrust Bolt, Centring Adaptors; Small, Large, Flat, Bolts;
2PC 1/4"28*2-12";
2PC 5/16"18*3-1/2";
2PC 5/16"18*5-1/2";
3PC 3/8"16*2";
2PC 3/8"16*3";
5PC 3/8"16*4-1/2";
3PC 3/8"24*1-1/2";
3PC M8*1.25*45mm;
2PC M8*1.25*65mm;
3PC M8*1.25*90mm;
3PC M10*1.5*35mm.

**DN-D1007****13pcs Harmonic Balance And Puller Tool
13件方向盘/齿轮拉拔器**

Versatile puller capable of removing a wide variety of components having tapped pulling holes such as gears, pulleys, etc. includes: Yoke 5/8-18" L 127mm, Thrust Bolt, Centring Adaptors; Small, Large, Flat, Bolts;
1PC 5/8-18;
2PCS 3/8-16;
3PCS 3/8-24;
2PCS M8*1.25";
3PCS 5/16-18;
1PC Pointed head

**DN-A1094****12 pcs Pulley Puller and Installer Set
12件滑轮拔轮器**

This set is perfect for mechanics both at home and in the professional auto shop to assist in pulley removal in a vehicle's pressed-on alternator and power steering mechanism. Features include reversible split jaws to get easy access to the pump pulley flange. This set is a great aid in pulley removal on domestic cars and light-duty trucks!
Comes complete with adapters for the GM 3.1 L and Quad 4 motor's unique style pulleys, as well as Ford's 4.6L metric requirements.
Has reversible split jaws for easy access to pulley flange
Works with most domestic cars and light-duty trucks, and some heavy duty trucks with belt driven pulleys.



DN-D1012

Nut Splitter
4件螺母破切器

Splits rusted hex nuts up to 1.1/16inch (27mm) across the flats.
Flat round head design allows tool to be used in inaccessible areas.
Cutting blade and forcing screw head have a ball joint drive to prevent binding under load.
Does not damage the bolt threads.
Sizes:
5/16"-1/2"(9-12mm)
1/2"-5/8"(12-16mm)
5/8"-7/8"(16-22mm)
7/2"-11/8"(22-27mm)"



DN-D1104
Universal C-Frame Nut Splitter
综合型螺母取出器

Forged and heat-treated frame with offset handle works where ordinary nut splitters may fail. Smooth action cracks nuts without damaging bolt threads.
Chisel rotates to line up parallel to bolt.
Splits non-heat-treated nuts of 7mm to 22mm diameter.



DN-D1059

4pcs Steering Rack Knuckle Tool Set
4件套轴接头工具

This tool set allows a quick and easy removal and replacement of the inner steering ball joint without the need to dismantle the steering rack from the bulkhead
Automatic clamping of the joint heads
3 exchangeable drive head range;30-35mm,35-40mm,40-45mm.
Works with 1/2"ratchet or 27mm socket.



DN-A1011

Mechanic's Stethoscope
汽缸听诊器

Stethoscope locates the source of engine noise quickly.
Listen for trouble by tracing the sound of flowing water, oil, gas or steam.
Identify piston slap, worn gears, faulty valves, waterpump failure, damaged gaskets and defective bearings.
Stethoscope has a shock-resistant handle and disassembles for storage.



Note: