

# **DRP-3200 / DBR-3200 / DHP-1U User's Manual**

<b>0.Safety Guidelines.....</b>	<b>1</b>
<b>1.Introduction.....</b>	<b>1</b>
1.1 Introduction.....	1
1.2 Features.....	1
1.3 Order Information.....	1
1.4 Main Specification.....	2
<b>2.Mechanical Specification and Input/Output Terminals.....</b>	<b>4</b>
2.1 Mechanism of Supply/Charger Unit.....	4
2.2 Mechanism of Whole Rack System.....	5
<b>3.Functions.....</b>	<b>7</b>
3.1 Input Voltage Range.....	7
3.2 Inrush Current Limiting.....	7
3.3 Rated Power.....	7
3.4 Power Factor Correction (PFC).....	7
3.5 Output Voltage/Current Adjustment.....	7
3.6 Fan Speed Control.....	9
3.7 Short-Circuit and Over-Current Protection.....	9
3.8 Over-Voltage Protection.....	9
3.9 Over-Temperature Protection and Alarm.....	9
3.10 AC OK Signal.....	9
3.11 DC OK Signal.....	9
3.12 Fan-Lock Protection and Alarm Signal.....	9
3.13 Remote Control.....	9
3.14 Remote Sense.....	9
3.15 Hot-Swap Operation.....	10
3.16 Parallel Operation.....	10
3.17 Series Operation.....	11
3.18 Auxiliary Power.....	12
3.19 DRP-3200 PMBus Communication Interface.....	12
3.20 DBR-3200 PMBus Communication Interface.....	14
3.21 CANBus Communication Interface.....	14
<b>4.Notes on Operation.....</b>	<b>20</b>
4.1 Installation Method.....	20
4.2 Derating.....	21
4.3 Warranty.....	21

## 0. Safety Guidelines

- ⊙ Risk of electrical shock and energy hazard, all failure should be examined by a qualified technician. Please do not remove the case from the supply/charger or rack shelf unit by yourself.
- ⊙ Please do not change any component on the unit or make any kind of modification on it.
- ⊙ Please do not install the unit in places with high moisture, high ambient temperature or under direct sunlight.
- ⊙ The input voltage range is 100- 240Vac (50/60Hz), please do not feed in voltage that is over or less than 10% of that range.
- ⊙ The safety protection level of this unit is class I. The " Frame Ground" (⊕) on the rack shelf unit must be well connected to PE (Protective Earth).

## 1. Introduction

### 1.1 Introduction

The DRP-3200 is a rack mountable power supply that provides energy source for telecom equipments, monitoring systems, servers, etc, installing into a 19" rack shelf is required for operation. The DBR-3200 is a rack mountable charger, used to charge batteries, installing into a 19" rack shelf is required for operation.

### 1.2 Features Description

- ⊙ 44 mm low profile, suitable for standard 1U rack applications
- ⊙ Universal AC input/Full range
- ⊙ Built-in active PFC function, PF>0.98
- ⊙ Protections: short circuit/overload/over voltage /over temperature
- ⊙ Active current sharing up to 12800W (4 units) in one 19" rack shelf; up to 2 rack shelves (8 units maximum) can be connected in parallel for DRP-3200
- ⊙ Remote control for each unit of DRP/DBU-3200 ◦
- ⊙ Built-in remote sense function for DRP-3200
- ⊙ Built-in battery temperature compensation function for DBR-3200
- ⊙ Output voltage programming
- ⊙ Output current programming
- ⊙ Hot Swap operation
- ⊙ AC OK and DC OK signal outputs
- ⊙ Forced air cooling by built-in DC fan with fan speed control function
- ⊙ 5V/0.3A and 12V/0.8A auxiliary output
- ⊙ Built-in ORing FETs ◦
- ⊙ PMBus serial data transmission function
- ⊙ 5 years warranty

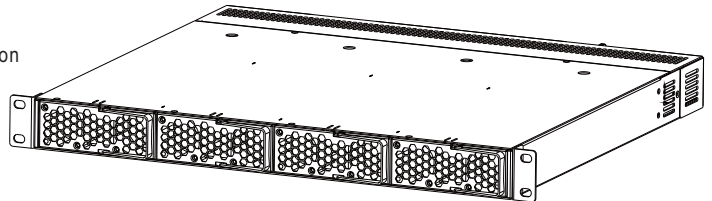

### 1.3 Order Information

#### 1.3.1 Explanation for Encoding

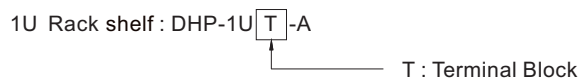
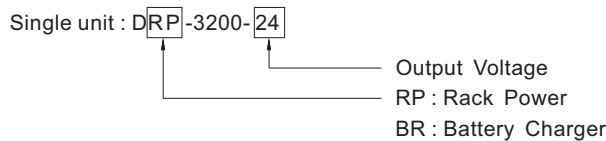

#### 1.3.2 Marking

- ⊙ Please refer to the safety label on the top of the unit before use (Figure 1-1~1-5)
- ⊙ Supply/Charger unit model

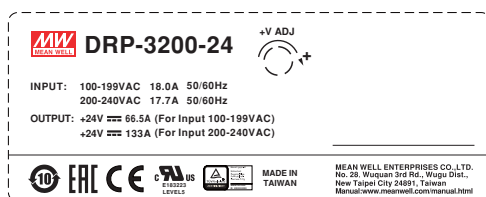

Figure1-1 safety label of DRP-3200

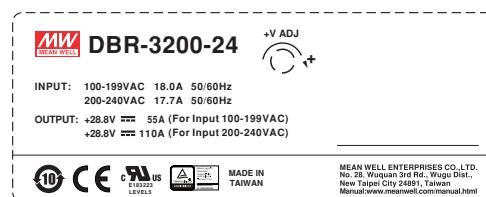

Figure1-2 safety label of DBR-3200

⊙Rack Shelf :

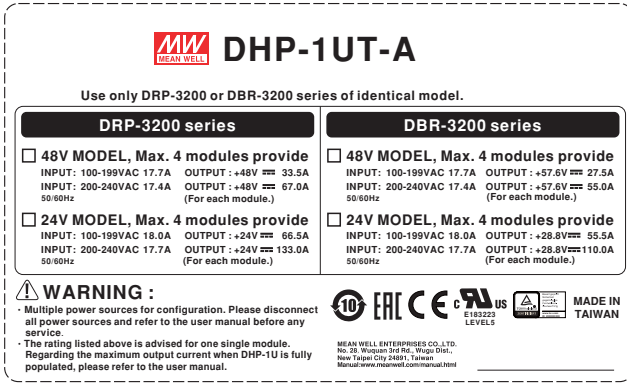

Figure 1-3: Safety label of DHP-1U

⊙Whole system :

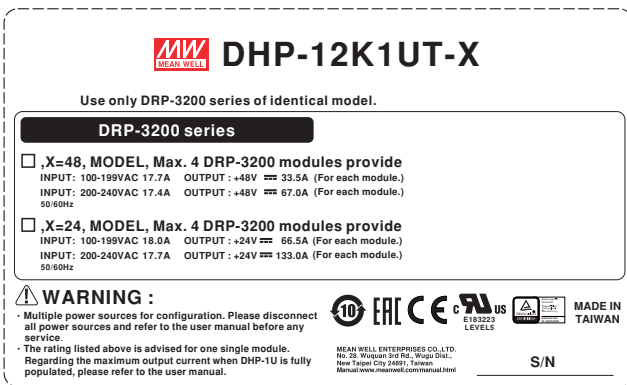

Figure 1-4: Safety label of the whole DHP system

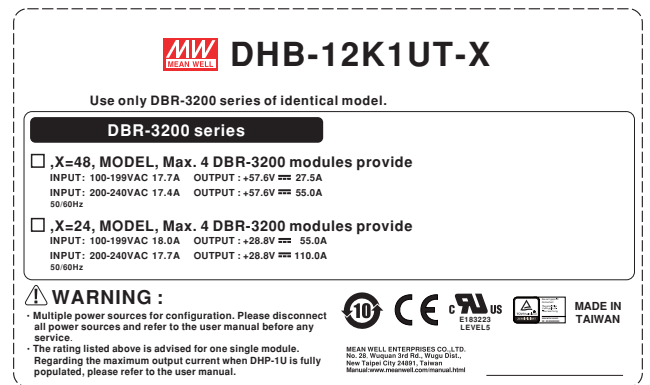

Figure 1-5: Safety label of the whole DHB system

1.4 Main Specification

⊙Supply/Charger unit

MODEL	DRP-3200-24	DRP-3200-48	
OUTPUT	DC VOLTAGE	24V	48V
	RATED CURRENT	133A	67A
	CURRENT RANGE	0 ~ 133A	0 ~ 67A
	RATED POWER	3192W	3216W
	RIPPLE & NOISE (max.) Note.2	300mVp-p	480mVp-p
	VOLTAGE ADJ. RANGE	23.5 ~ 30V	47.5 ~ 58.8V
	VOLTAGE TOLERANCE Note.4	± 1.0%	± 1.0%
	LINE REGULATION	± 0.5%	± 0.5%
	LOAD REGULATION	± 0.5%	± 0.5%
	SETUP, RISE TIME	1500ms, 60ms/230VAC at full load	
HOLD UP TIME (Typ.)	16ms / 230VAC at 75% load      9ms / 230VAC at full load		
INPUT	VOLTAGE RANGE Note.5	90 ~ 264VAC      127 ~ 370VDC	
	FREQUENCY RANGE	47 ~ 63Hz	
	POWER FACTOR (Typ.)	0.97/230VAC at full load	
	EFFICIENCY (Typ.) Note.6	93.5%	94.5%
	AC CURRENT (Typ.) Note.5	17A/230VAC	
	INRUSH CURRENT (Typ.)	COLD START 55A/230VAC	
	LEAKAGE CURRENT	<1.5mA / 230VAC	
PROTECTION	OVERLOAD	105 ~ 115% rated output power Protection type : Constant current limiting, shut down O/P voltage 5 sec. after O/P voltage is down low, re-power on to recover	
	OVER VOLTAGE	31.5 ~ 37.5V	63 ~ 75V
	OVER TEMPERATURE	Shut down o/p voltage, recovers automatically after temperature goes down	

MODEL		DBR-3200-24	DBR-3200-48
OUTPUT	BOOST CHARGE VOLTAGE(Vboost)(default)	28.8V	57.6V
	FLOAT CHARGE VOLTAGE(Vfloat)(default)	27.6V	55.2V
	CONSTANT CURRENT(CC)(default)	110A	55A
	VOLTAGE ADJ. RANGE	By built-in potentiometer, SVR	
		23.5 ~ 30V	47.5 ~ 58.8V
	RECOMMENDED BATTERY CAPACITY(AMP HOURS) Note.3	330 ~ 1000Ah	180 ~ 550Ah
LEAKAGE CURRENT FROM BATTERY (Typ.)	<1.5mA		
INPUT	VOLTAGE RANGE Note.4	90 ~ 264VAC 127 ~ 370VDC	
	FREQUENCY RANGE	47 ~ 63Hz	
	POWER FACTOR (Typ.)	0.97/230VAC at full load	
	EFFICIENCY (Typ.)	93.5%	94.5%
	AC CURRENT (Typ.) Note.4	17A/230VAC	
	INRUSH CURRENT (Typ.)	COLD START 55A/230VAC	
	LEAKAGE CURRENT	<1.5mA / 230VAC	
PROTECTION	OVER VOLTAGE	31.5 ~ 37.5V	63 ~ 75V
		Protection type : Shut down o/p voltage, re-power on to recover	
	OVER TEMPERATURE	Shut down o/p voltage, recovers automatically after temperature goes down	

◎Rack system

MODEL		DHP-12K1U□-24	DHP-12K1U□-48	
OUTPUT	RECTIFIER	DRP-3200-24	DRP-3200-48	
	OUTPUT VOLTAGE	24V	48V	
	MAX. OUTPUT CURRENT	532A	268A	
	MAX. OUTPUT POWER Note.4	12768W	12864W	
INPUT	VOLTAGE RANGE Note.5	90 ~ 264VAC 127 ~ 370VDC		
	FREQUENCY RANGE	47 ~ 63Hz		
	AC CURRENT (Typ.) per RECTIFIER	17A/230VAC		
	LEAKAGE CURRENT per RECTIFIER Note.7	<1.5mA / 230VAC		
FUNCTION	OUTPUT VOLTAGE PROGRAMMABLE(PV)	Adjustment of output voltage is allowable to 50 ~ 125% of nominal output voltage. Please refer to the Function Manual.		
	CONSTANT CURRENT LEVEL PROGRAMMABLE(PC)	Adjustment of constant current level is allowable to 20 ~ 100% of rated current. Please refer to the Function Manual.		
	REMOTE ON-OFF CONTROL	By electrical signal or dry contact ON:short OFF:open		
	REMOTE SENSE	Compensate voltage drop on the load wiring up to 0.5V		
	AUXILIARY POWER	5V @ 0.3A, tolerance ±10%, ripple 150mVp-p, 12V @ 0.8A, tolerance ±10%, ripple 450mVp-p		
	ALARM SIGNAL	Isolated TTL signal output for T-Alarm, AC-OK and DC-OK		
ENVIRONMENT	WORKING TEMP.	-30 ~ +70°C, when 3 or 4 power/charger units are paralleled in power shelf, highest working temperature shall de-rate to 40°C at full load		
	WORKING HUMIDITY	20 ~ 90% RH non-condensing		
	STORAGE TEMP., HUMIDITY	-40 ~ +85°C, 10 ~ 95% RH non-condensing		
	TEMP. COEFFICIENT	±0.03%/°C (0 ~ 50°C)		
	VIBRATION	10 ~ 500Hz, 2G 10min./1cycle, 60min. each along X, Y, Z axes		
SAFETY & EMC (Note 8)	SAFETY STANDARDS	UL60950-1, TUV EN60950-1 approved		
	WITHSTAND VOLTAGE	I/P-O/P:3KVAC I/P-FG:2KVAC O/P-FG:700VDC		
	ISOLATION RESISTANCE	I/P-O/P, I/P-FG, O/P-FG:100M Ohms / 500VDC / 25°C / 70% RH		
	EMC EMISSION	Parameter	Standard	Test Level / Note
		Conducted	EN55032 (CISPR32) / EN55011 (CISPR11)	Class B
		Radiated	EN55032 (CISPR32) / EN55011 (CISPR11)	Class A
		Harmonic Current	EN61000-3-2	Class A
		Voltage Flicker	EN61000-3-3	-----
	EMC IMMUNITY	EN55024, EN61204-3, EN61000-6-2		
		Parameter	Standard	Test Level / Note
		ESD	EN61000-4-2	Level 3, 8KV air ; Level 2, 4KV contact
		Radiated	EN61000-4-3	Level 3
		EFT / Burst	EN61000-4-4	Level 3
		Surge	EN61000-4-5	Level 4, 2KV/Line-Line 4KV/Line-Earth
Conducted		EN61000-4-6	Level 3	
Magnetic Field		EN61000-4-8	Level 4	
Voltage Dips and Interruptions	EN61000-4-11	>95% dip 0.5 periods, 30% dip 25 periods, >95% interruptions 250 periods		

<b>MODEL</b>	<b>DHP-12K1U□-24</b>	<b>DHP-12K1U□-48</b>
<b>OTHERS</b>	<b>DIMENSION</b>	Rack 400*482.6*44(L*W*H, with mounting bracket) ; 365*440*44(L*W*H, without mounting bracket)
	<b>PACKING</b>	4.85Kg; 3pcs/17.4Kg/1.8CUFT
<b>NOTE</b>	<p>1. All parameters NOT specially mentioned are measured at 230VAC input, rated load and 25°C of ambient temperature.</p> <p>2. Ripple &amp; noise are measured at 20MHz of bandwidth by using a 12" twisted pair-wire terminated with a 0.1uf &amp; 47uf parallel capacitor. Under parallel operation of more than one rack connecting together, ripple of the output voltage may be higher than the SPEC at light load condition. It will go back to normal ripple level once the output load is more than 5%.</p> <p>3. Tolerance : includes set up tolerance, line regulation and load regulation.</p> <p>4. Output of all the DRP-3200 modules are connected in parallel in the rack.</p> <p>5. Derating may be needed under low input voltages. Please check the static characteristics for more details.</p> <p>6. Because of component tolerance, there is a possibility that some of units connected in parallel will reach an overcurrent limit then overloading the other units when operating at full load condition. If overload conditions happen in parallel usage, it is suggested that derate the total output current by 10%.</p> <p>7. The equivalent leakage current of the system is determined by the quantity of populated rectifiers.</p> <p>8. The power supply is considered a component which will be installed into a final equipment. All the EMC tests are been executed by mounting the unit on a 1000mm*1300mm metal plate with 2mm of thickness. The final equipment must be re-confirmed that it still meets EMC directives. For guidance on how to perform these EMC tests, please refer to "EMI testing of component power supplies." (as available on <a href="http://www.meanwell.com">http://www.meanwell.com</a>)</p> <p>9. The ambient temperature derating of 3.5°C/1000m with fanless models and of 5°C/1000m with fan models for operating altitude higher than 2000m(6500ft).</p>	

<b>MODEL</b>	<b>DHB-12K1U□-24</b>	<b>DHB-12K1U□-48</b>	
<b>OUTPUT</b>	<b>CHARGER</b>	DBR-3200-24	DBR-3200-48
	<b>BOOST CHARGE VOLTAGE(Vboost)(default)</b>	28.8V	57.6V
	<b>FLOAT CHARGE VOLTAGE(Vfloat)(default)</b>	27.6V	55.2V
	<b>CURRENT RANGE</b>	0 ~ 440A	0 ~ 220A
<b>INPUT</b>	<b>VOLTAGE RANGE</b> Note.2	90 ~ 264VAC	127 ~ 370VDC
	<b>FREQUENCY RANGE</b>	47 ~ 63Hz	
	<b>AC CURRENT (Typ.) per CHARGER</b>	17A/230VAC	
	<b>LEAKAGE CURRENT per CHARGER</b> Note.4	<1.5mA / 230VAC	
<b>FUNCTION</b>	<b>OUTPUT VOLTAGE PROGRAMMABLE(PV)</b>	Adjustment of output voltage is allowable to 75 ~ 125% of nominal output voltage. Please refer to the Function Manual.	
	<b>OUTPUT CURRENT PROGRAMMABLE(PC)</b>	Adjustment of output current is allowable to 20 ~ 100% of rated current. Please refer to the Function Manual.	
	<b>REMOTE ON-OFF CONTROL</b>	By electrical signal or dry contact ON: short OFF: open	
	<b>AUXILIARY POWER</b>	5V @ 0.3A, tolerance ±10%, ripple 150mVp-p, 12V @ 0.8A, tolerance ±10%, ripple 450mVp-p	
	<b>ALARM SIGNAL</b>	The isolated TTL signal out, Please refer to Installation Manual	
	<b>TEMPERATURE COMPENSATION</b>	-3mV / °C / cell / (24V = 12 cells ; 48V = 24 cells)	
<b>ENVIRONMENT</b>	<b>WORKING TEMP.</b>	-30 ~ +70°C (Refer to "Derating Curve")	
	<b>WORKING HUMIDITY</b>	20 ~ 90% RH non-condensing	
	<b>STORAGE TEMP., HUMIDITY</b>	-40 ~ +85°C, 10 ~ 95% RH non-condensing	
	<b>TEMP. COEFFICIENT</b>	±0.03%/°C (0 ~ 50°C)	
<b>SAFETY &amp; EMC (Note 5)</b>	<b>WITHSTAND VOLTAGE</b>	I/P-O/P:3KVAC I/P-FG:2KVAC O/P-FG:700VDC	
	<b>ISOLATION RESISTANCE</b>	I/P-O/P, I/P-FG, O/P-FG:100M Ohms / 500VDC / 25°C / 70% RH	
	<b>EMC EMISSION</b>	Compliance to EN55032 (CISPR32) Conduction Class B, Radiation Class A ; EN61000-3-2,-3	
	<b>EMC IMMUNITY</b>	Compliance to EN61000-4-2,3,4,5,6,8,11, EN61000-6-2 (EN50082-2), Heavy industry level, criteria A	
	<b>OTHERS</b>	<b>DIMENSION</b>	Rack 400*482.6*44(L*W*H, with mounting bracket) ; 365*440*44(L*W*H, without mounting bracket)
<b>NOTE</b>	<b>PACKING</b>	5.5Kg; 3pcs/17.5Kg/2.11CUFT	
	<p>1. All parameters NOT specially mentioned are measured at 230VAC input, rated load and 25°C of ambient temperature.</p> <p>2. Derating may be needed under low input voltages. Please check the static characteristics for more details.</p> <p>3. Output of all the DBR-3200 modules are connected in parallel in the rack.</p> <p>4. The equivalent leakage current of the system is determined by the quantity of populated chargers.</p> <p>5. The power supply is considered a component which will be installed into a final equipment. All the EMC tests are been executed by mounting the unit on a 1000mm*1300mm metal plate with 2mm of thickness. The final equipment must be re-confirmed that it still meets EMC directives. For guidance on how to perform these EMC tests, please refer to "EMI testing of component power supplies." (as available on <a href="http://www.meanwell.com">http://www.meanwell.com</a>)</p> <p>6. The ambient temperature derating of 3.5°C/1000m with fanless models and of 5°C/1000m with fan models for operating altitude higher than 2000m(6500ft).</p>		

## 2. Mechanical Specification and Input/Output Terminals

### 2.1 Mechanism of Supply/Charger unit

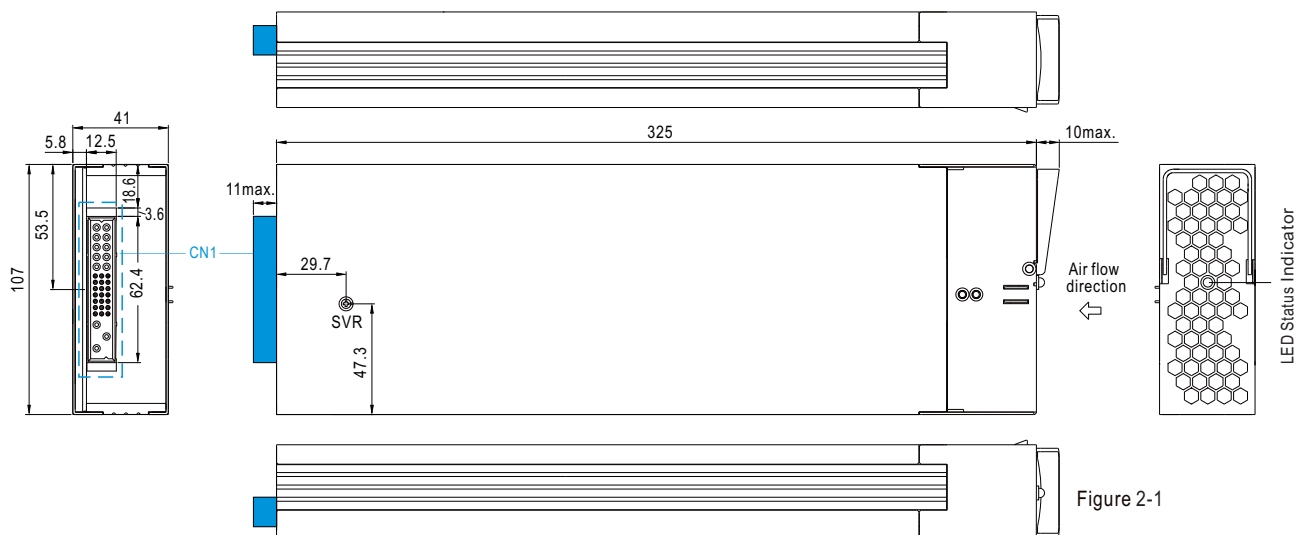
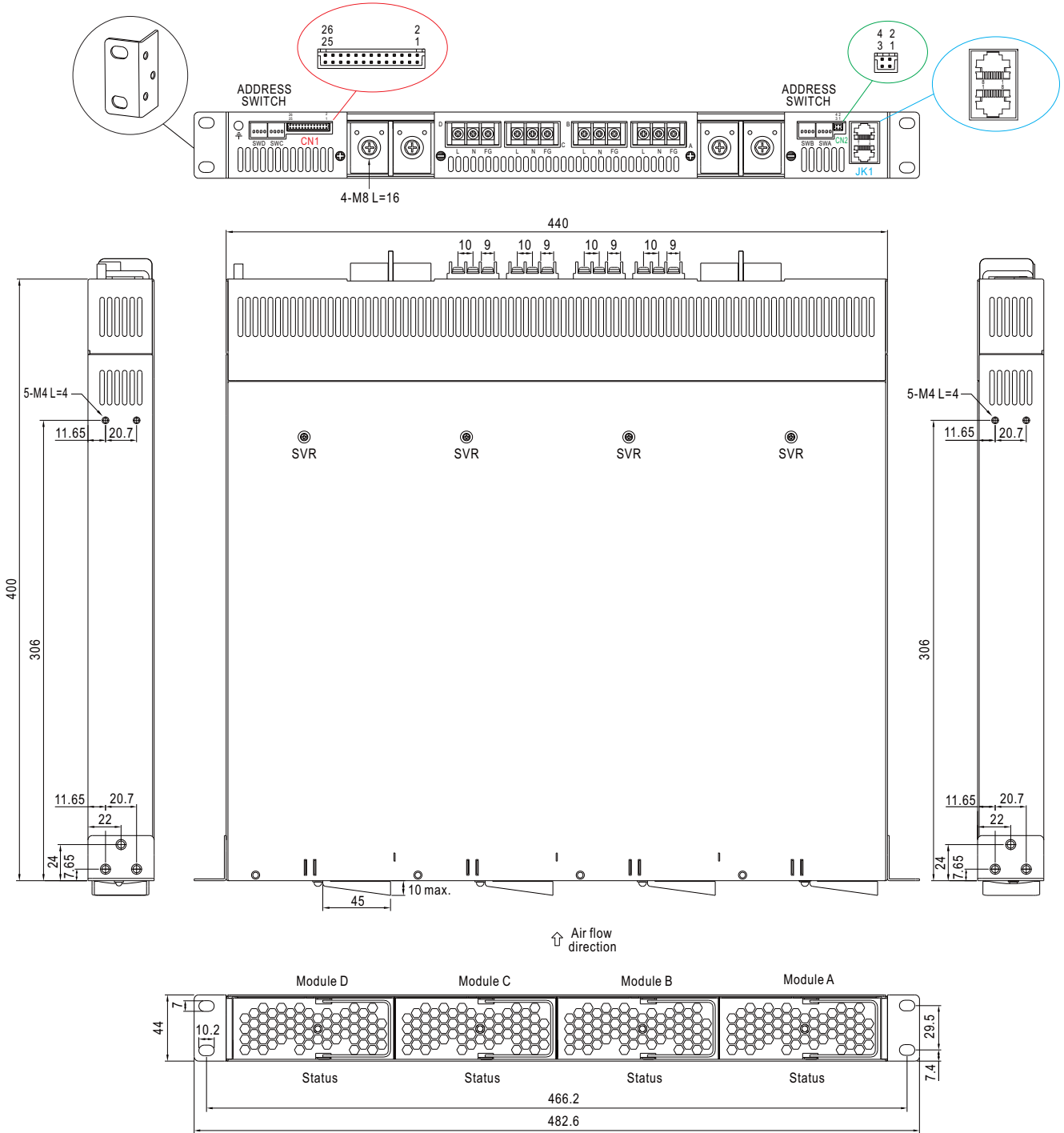

Figure 2-1

## 2.2 Mechanism of Whole Rack System



※ LED Status Indicators & Corresponding Signal at Function Pins

For power supply system

LED	Description
● Green	The power supply functions normally
● Red (Flashing)	The LED will flash with red light when internal temperature reaches 60°C; under this condition, the unit still operates normally without entering OTP. (In the meantime, an alarm signal will be sent out through the PMBus /CANBus interface.)
● Red	The LED will present a constant red light when the abnormal status (OTP, OLP, fan fail and charging timeout) arises.

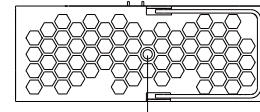

LED Status Indicator

Figure 2-3 DRP/DBR-3200 front panel

For charger system

LED	Description
● Green	Float(stage 3)
● Orange	Charging (stage 1 or stage 2)
● Red (Flashing)	The LED will flash with red light when internal temperature reaches 60°C; under this condition, the unit still operates normally without entering OTP. (In the meantime, an alarm signal will be sent out through the PMBus interface.)
● Red	The LED will present a constant red light when the abnormal status (OTP, OLP, fan fail and charging timeout) arises.

※ Connector Pin No. Assignment (CN1)

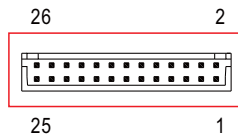

Pin No.	Function	Description
1,5,9,13,17	AC-OK	High (4.5 ~ 5.5V) : When the input voltage is $\geq 87V_{rms}$ . Low (-0.1 ~ 0.5V) : When the input voltage is $\leq 75V_{rms}$ . The maximum sourcing current is 10mA and only for output. (Note.2)
2,6,10,14,18	DC-OK	For power supply system High (4.5 ~ 5.5V) : When the $V_{out} \leq 80\% \pm 5\%$ . Low (-0.1 ~ 0.5V) : When $V_{out} \geq 80\% \pm 5\%$ . The maximum sourcing current is 10mA and only for output. (Note.2)
		For charger system High (4.5 ~ 5.5V) : When the $V_{out} \leq 16V/32V \pm 1V$ . Low (-0.1 ~ 0.5V) : When $V_{out} \geq 16V/32V \pm 1V$ . The maximum sourcing current is 10mA and only for output. (Note.2) DC OK is associated with battery low protection.
3,7,11,15,19	Remote ON-OFF	The unit can turn the output ON/OFF by electrical signal or dry contact between Remote ON-OFF and +5V-AUX. (Note.2) Short (4.5 ~ 5.5V) : Power ON ; Open (0 ~ 0.5V) : Power OFF ; The maximum input voltage is 5.5V.
4,8,12,16,20	T-ALARM	High (4.5 ~ 5.5V) : When the internal temperature exceeds the limit of temperature alarm, or when fan fails. Low (-0.1 ~ 0.5V) : When the internal temperature is normal, and when fan works normally. The maximum sourcing current is 10mA and only for output(Note.2)
21	+5V-AUX	Auxiliary voltage output, 4.5~5.5V, referenced to GND-AUX (pin 22). The maximum load current is 0.3A. This output has the built-in "Oring diodes" and is not controlled by the remote ON/OFF control.
22	GND-AUX	Auxiliary voltage output GND. The signal return is isolated from the output terminals (+V & -V).
23	+12V-AUX	Auxiliary voltage output, 10.8~13.2V, referenced to GND-AUX (pin 22). The maximum load current is 0.8A. This output has the built-in "Oring diodes" and is not controlled by the remote ON/OFF control.
24	-V(Signal)	Negative output voltage. For local sense use only; It can't be connected directly to the load.
25	PC	Connection for output current programming. The current can be trimmed within its defined range. (Note.1)
26	PV	Connection for output voltage programming. The voltage can be trimmed within its defined range. (Note.1)

Note.1: Non-isolated signal, referenced to [-V(signal)].

Note.2: Isolated signal, referenced to GND-AUX.

※ Connector Pin No. Assignment (CN2)

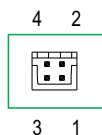

Note3: Wiring cable of CN2 varies in rack shelf with DRP-3200 or DBR-3200, please follow the discription below to select the correct cable for wiring, DO NOT make it misplaced!

For power supply system

1	+S	Positive sensing. The +S signal should be connected to the positive terminal of the load. The +S and -S leads should be twisted in pair to minimize noise pick-up effect. The maximum line drop compensation is 0.5V.
2	-S	Negative sensing. The -S signal should be connected to the negative terminal of the load. The -S and +S leads should be twisted in pair to minimize noise pick-up effect. The maximum line drop compensation is 0.5V.
3	+V(Signal)	Positive output voltage. For local sense use only, can't be connected directly to the load.
4	-V(Signal)	Negative output voltage. For local sense use only, can't be connected directly to the load.

◎ The RED wiring cable goes with the DRP-3200, used to compensate voltage drop on the load wiring.





☉ For charger system

1	RTH+	Temperature sense associated with the temperature compensation function.
2	RTH-	
3,4	NC	Not use.

☉ The Black wiring cable goes with the DBR-3200, used for battery temperature compensation.



※ Connector Pin No. Assignment(JK1) : RJ45 8 positions

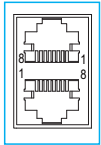

Pin No.	Function	Description
1,2	DA,DB	Differential digital signal for parallel control. (Note.1)
3	-V(signal)	Negative output voltage signal. It is for local sense and certain function reference; it cannot be connected directly to the load.
4	CONTROL	Remote ON-OFF control pin used in the PMBus interface. (Note.2)
5	NC	Retain for future use.
6	SDA	For PMBus model: Serial Data used in the PMBus interface. (Note.2)
	CANH	For CANBus model: Data line used in CANBus interface. (Note.2)
7	SCL	For PMBus model: Serial Clock used in the PMBus interface. (Note.2)
	CANL	For CANBus model: Data line used in CANBus interface. (Note.2)
8	GND-AUX	Auxiliary voltage output GND. The signal return is isolated from the output terminals (+V & -V).

Note.1: Non-isolated signal, referenced to [-V(signal)].

Note.2: Isolated signal, referenced to GND-AUX.

### 3.Functions

#### 3.1 Input Voltage Range

- ☉ The input voltage rang is AC90~264V or DC127~370V.
- ☉ To insure proper operation, AC input should be within the pre-specified range. A wrong input will cause the supply/charger units operating improperly, losing PFC function or even damaging the units in worst case scenario.
- ☉ The efficiency will be lower and the output current will be automatically limited to a predetermined safe value if the units are applied with a lower input voltage. Please refer to 4.2 Derating for more information.

#### 3.2 Inrush Current Limiting

- ☉ Built-in inrush current limiting circuit.
- ☉ If adding an external switch (relay/circuit break) at the input side is required, choose switches that are able to withstand inrush current of the units.
- ☉ Since the inrush limiting circuit mainly consists of a thermistor and a relay, inrush current will be much higher than the specified value if input thermistor is not allowed sufficient time to cool down. After turning off the supplies/chargers, a 10 second cool down period is recommended before turning them on again.

#### 3.3 Output Power

☉ Front end unit

DRP-3200-24 : 3192W (24V / 133A)

DRP-3200-48 : 3216W (48V / 67A)

DBR-3200-24 : 3168W (28.8V / 110A)

DBR-3200-48 : 3168W (57.6V / 55A)

☉ Whole System

DHP-12K1U□-24 : 12800W (24V / 532A)

DHP-12K1U□-48 : 12800W (48V / 266A)

DHB-12K1U□-24 : 12672W (28.8V / 440A)

DHB-12K1U□-48 : 12672W (57.6V / 220A)

#### 3.4 Power Factor Correction(PFC)

- ☉ Built-in active power factor correction (PFC) function, power factor (PF) will be 0.98 or better when the input voltage is in a range of 90 -230Vac and operated at full load condition. PF will be less than 0.98 if the output is not at full load or the input voltage is higher than 230Vac.

#### 3.5 Output Voltage/Current Adjustment

##### 3.5.1 Adjustment of single unit

Output voltage can be trimmed by adjusting SVR (which can be found under the small circular hole, located on the top of the unit). Please utilize an insulated cross-head screwdriver to make an adjustment.

### 3.5.2 Voltage adjustment of whole rack system by an external 0-5 Vdc source (Output Voltage Programming)

- (1) Connect output of the external DC source to PV(PIN 26) and -V(PIN 24) on CN1, as shown in Figure3-1.
- (2) Relationship between the output voltage and the external DC source is shown in Figure3-2.
- (3) When increase the output to a higher voltage level, please reduce the load current accordingly. Output wattage of each unit should not exceed the rated value under any circumstances.

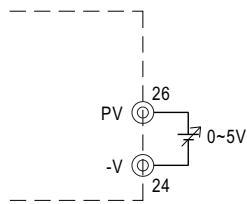

Figure 3-1 Connection of external DC voltage source

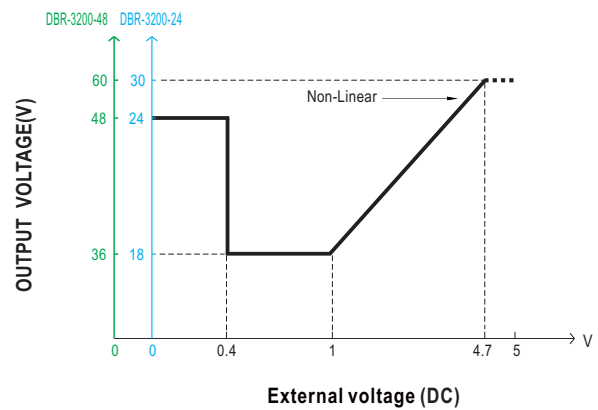
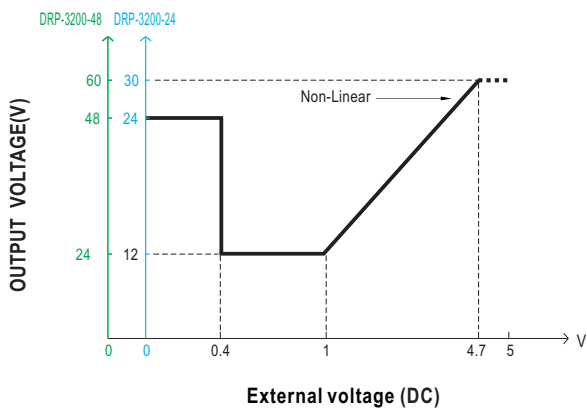
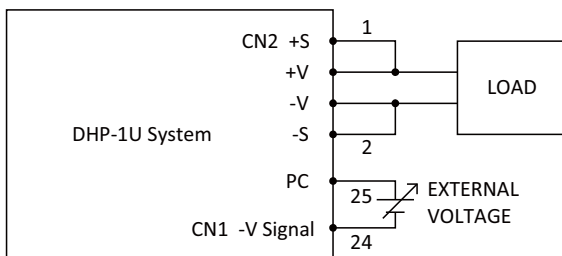

Figure 3-2

### 3.5.3 Output current adjustment (Output Current Programming)

※ Constant current level (DRP-3200)/output current (DBR-3200) can be adjusted within a range of 20-100% of the rated current via an external DC source, the wiring is show as below.



Connection between +S & +V, -S & -V on CN1 is required (DRP-3200system)

Relationship between the output current and the external DC source is shown as below.

© DRP-3200 System

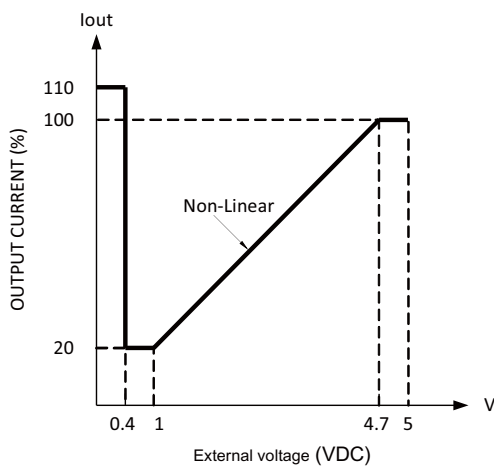

© DBR-3200 System

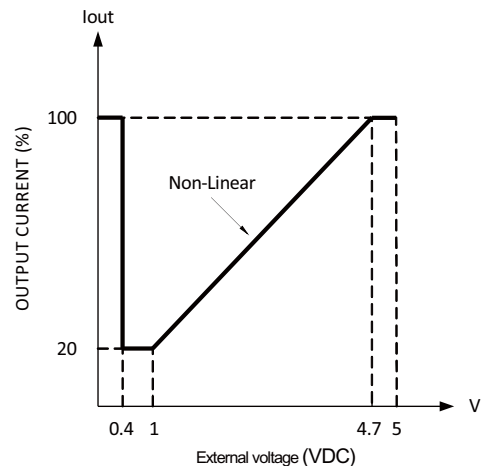

Note: The DRP-3200 will trigger OLP to shut down itself if the output stays on constant current level condition for more than 5 seconds.

### 3.6 Fan Speed Control

- ⊙ Built-in fan speed control circuit, fan speed changes automatically depending on internal temperature.

### 3.7 Short Circuit Protection & Over Current Protection

- ⊙ Only for DRP-3200.
- ⊙ The protection activates when the output is short-circuited or the output current exceeds 110%±5% of the rated output current. Re-power on to recover when the short-circuit/overload condition is removed.

### 3.8 Over Voltage Protection (OVP)

- ⊙ Built-in over voltage protection circuit for every single units.
- ⊙ OVP triggering points vary in different output models. Please refer to the specification sheet for detailed information.
- ⊙ Once OVP is triggered, leave the units off for 10 seconds before recycling AC again.

### 3.9 Over Temperature Protection (OTP) and Alarm

- ⊙ Built-in 2 sets of thermal detection circuit, once the internal temperature exceeds a threshold value, the units will shut down automatically (the fans will still be operating to cool down the unit). Please switch off the AC input, remove all possible causes and then leave the units cooling down to a normal working temperature (approximate 10 minutes – 1 hour) before repower on again.
- ⊙ When the internal temperature reaches 60°C, trigger point of a thermal alarm, the red LED on the front panel will flash and there will be an alarm signal sent out through the PMBus/CANBus interface (refer to 3.19). Even so, the units still operate normally.
- ⊙ When the internal temperature is within a normal value, there will be a "LOW" signal (-0.1 -0.5V) sent out through T-ALARM on CN1; there will be a "HIGH" signal (4.5 -5.5V) sent out through T-ALARM on CN1 when internal temperature exceeds a certain value. (referenced to GND-AUX).
- ⊙ Maximum output current: 10mA.

### 3.10 AC OK signal

- ⊙ Built-in AC input voltage detection circuit.
- ⊙ When AC input voltage  $\geq 87V_{rms}$ , the output voltage can start working normally and there will be a "HIGH" signal (4.5-5.5V) sent out through AC-OK on CN1. (referenced to GND-AUX).
- ⊙ When AC input voltage  $\leq 75V_{rms}$ , The output voltage shuts off and the red LED on the front panel will light up. In the mean time, there will be a "LOW" signal (-0.1-0.5V) sent out through AC-OK on CN1. (referenced to GND-AUX).
- ⊙ Maximum output current 10mA.

### 3.11 DC OK signal

- ⊙ Built-in DC output voltage detection circuit.
- ⊙ When DC output voltage is within a normal value, there is a "LOW" (-0.1-0.5V) signal sent out through DC-OK on CN1. (referenced to GND-AUX).
- ⊙ When DC output voltage is out of normal range, there is a "HIGH" (4.5-5.5V) signal sent out through DC-OK on CN1. (referenced to GND-AUX).
- ⊙ Maximum output current 10mA.

### 3.12 Fan-lock Protection & Alarm Signals

- ⊙ Built-in fan-lock protection circuit, the output will shut off when the DC fans stop operating (fan-lock or broken wires). In the meantime, there will be a "HIGH" signal sent out through T-ALARM, referenced to GND-AUX. Please remove the unit from your system and send back to our local distributor or MEAN WELL for repair.
- ⊙ Maximum output current 10mA.

### 3.13 Remote Control

- ⊙ Built-in remote ON/OFF control circuit, refer to Figure 3-3 for control methods of single unit or whole rack system.
- ⊙ Please be aware that "ON/OFF" and "+5V-AUX" on CN1 should be linked together to allow the units operate normally; If kept open, there will be no output voltage.
- ⊙ Maximum input voltage 5.5V.

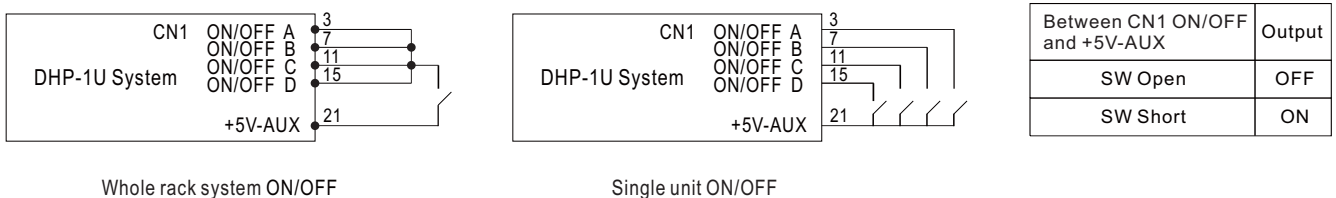

Figure 3-3 Connection of Remote Control

### 3.14 Remote Sense

- ⊙ Only for DRP-3200.
- ⊙ Built-in remote sense circuit that is able to compensate voltage drop up to 0.5V.
- ⊙ When using this function, the sensing wires should either be twisted or shielded to prevent external noise interference (refer to Figure 3-4).
- ⊙ Voltage drop across the output wires must be limited to less than 0.5V. Also wires with adequate current rating should be used between +V, -V and the loads. Please firmly connect the output wires to prevent them from loosing, or the power supply may be out of order.
- ⊙ The +S and -S have to be connected to the +V(signal) and -V(signal), respectively, as shown in Figure 3-5, which is Local Sense, in order to get the correct output voltage if Remote Sense is not used. Otherwise, the output voltage will increase to a extremely high level which may trigger OVP.

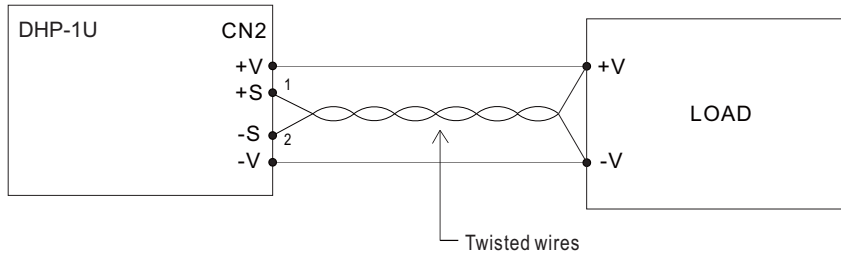

Figure 3-4 Connection of Remote Sense

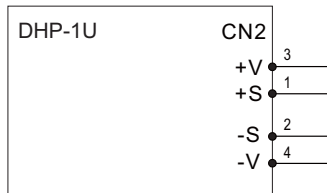

Figure 3-5 Connection of Local Sense

### 3.15 Hot Swap Operation

- ⊙ Built-in "Oring MOSFET", the units can be installed/removed without turning power off.
- ⊙ Insert units: Grasp the handle and push into the rack shelf through the rail.

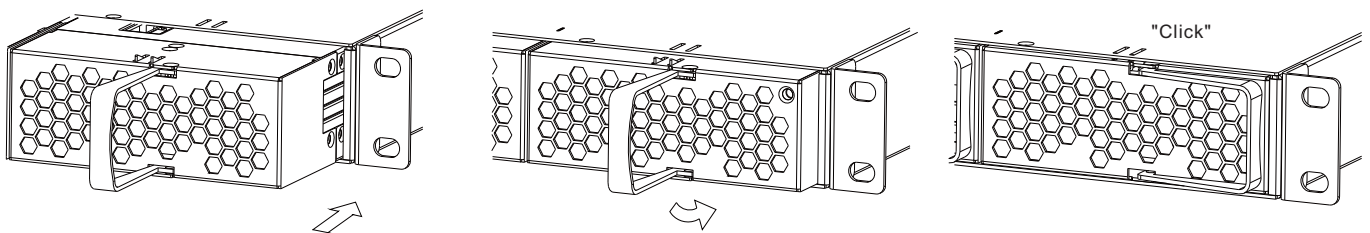

Figure 3-6 Illustration of how to insert the DRP/DBR-3200 into a rack

- ⊙ Pull out units: Press the clip shown in Figure 3-7 and pull it out.

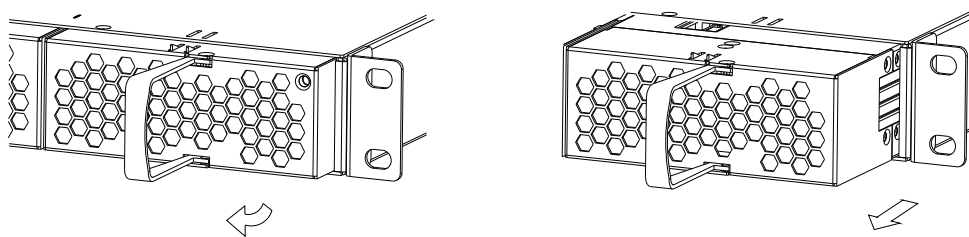

Figure 3-7 Illustration of how to remove the DRP/DBR-3200 from a rack

Caution: Please use adequate force to insert the DRP/DBR-3200 into the rack shelf. Slamming units into the rack can damage the connectors both on the rear of the units and inside the rack.

### 3.16 Parallel Operation

#### 3.16.1 Operation of Single Rack Shelf

- ⊙ Parallel operation in a single rack shelf is only suitable for the identical units (with the same model and the same output voltage/current).
- ⊙ Each rack shelf (DHP-1U□) has built-in parallel connection/wiring. Once have DRP or DBR units inserted in the rack shelf then these front end unit are operated in parallel.
- ⊙ Please refer to 3.13 & 3.14 for the connection/wiring of other functions.

### 3.16.2 Operation of two rack shelves in parallel (DRP-3200 system)

- ⊙ Parallel operation is only suitable for the identical units (with the same model and the same output voltage/current). Up to 2 rack shelves and the maximum supply units that can be connected in parallel is 8.
- ⊙ Because of component tolerance, there is a possibility that some of the units connected in parallel will reach an overcurrent limiting then overloading the other units when operating at full load condition. It is suggested that reduce the total output current by 10%.  
For example: DRP-3200-24x8 connected in parallel (in 2 rack shelves), the total output current should be reduced to  $133A \times 8\text{unit} \times 0.9 = 957.6A$ .
- ⊙ Difference of output voltage among parallel units should be less than 0.2V.
- ⊙ Configure rack shelf units in parallel before connecting to the load. Do not connect rack shelf units to the load separately. Refer to Figure 3-8
- ⊙ Control singles of DA, DB and -V should also be connected in parallel. (Refer to Figure 3.8).
- ⊙ Use twisted wires for the wiring of +S and -S, the twisted wires should not touch the load wires to avoid interference. Refer to Figure 3-8.
- ⊙ A too long cable length might be with a higher amount of noise that affects rack units' proper operation in parallel. To reduce the noise, installing termination resistors, an accessory, to the unused JK1 is recommended.

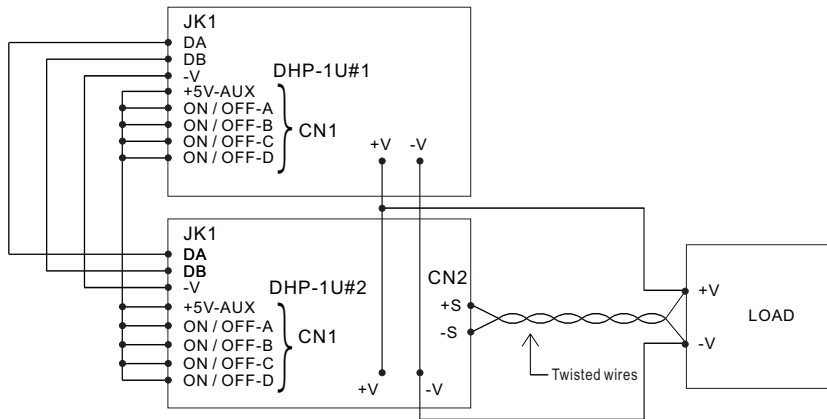

Figure 3-8 Configuration of two rack shelf units in parallel

- ⊙ Under operation of more than one rack shelf in parallel, value of Ripple & Noise may be larger than that stated in the specification at light load or no load condition. It will return to normal level once the loads draw more current than 10% of the total rating.

### 3.17 Series Operation

- ⊙ Higher output voltage can be acquired by connecting rack shelves in series.
- ⊙ The rack shelves (DHP-1U□) connected in series should have the identical units. Please refer to Figure3-9 for wiring configuration.
- ⊙ Total output current should not exceed currents that can be produced in each rack shelf.
- ⊙ Difference of rise time in each unit may lead to steps/stairs like turn on.
- ⊙ The total rating of output voltage in series should be less than 60Vdc [the requirement of SELV (Safety Extra Low Voltage) of IEC62368-1].
- ⊙ It is suggested that add external diodes (\*) on the output, shown in Figure 3-9, to prevent reverse voltage. Rating of these diodes should be higher than the total amount of output voltage and current.

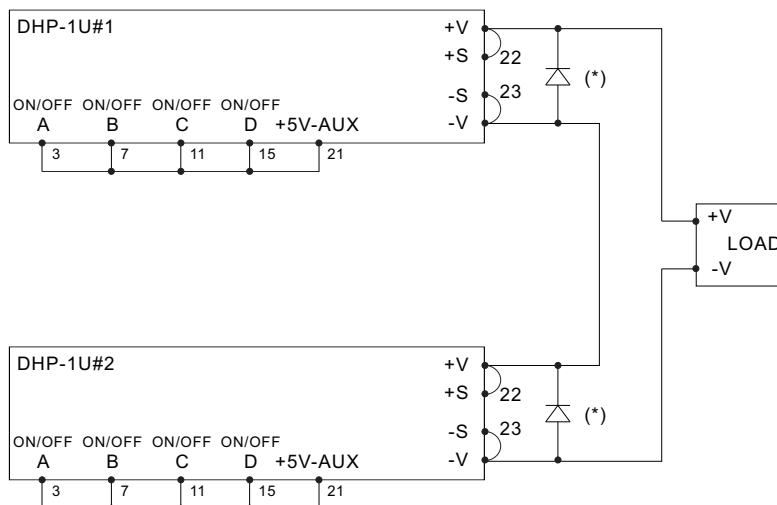

Figure 3-9 Configuration of rack shelf units in series

### 3.18 Auxiliary Output

- ⊙ Built-in 5V/0.3A and 12V/0.8A auxiliary output.

### 3.19 DRP-3200 PMBus Communication Interface

- ⊙ DRP-3200 is compliant with PMBus Rev.1.1, the maximum communication speed is 100KHz and it has the capability of identifying up to 16 addressed units.
- ⊙ PMBus communication interface is able to provide the current operating status and information as follows:
  1. Output voltage, current and internal temperature.
  2. Alarm and status.
  3. Manufacturers and model data.

#### 3.19.1 DRP-3200 PMBus Addressing

- ⊙ Each DRP-3200 unit should have their unique and own device address to communicate over the PMBus. 7-bit address setting pins are used to assign a device address for a DRP-3200 unit, as shown in the description below.

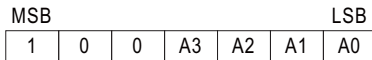

- ⊙ A0-A3 allow users to designate the address for each DRP-3200 unit; these four bits are defined through a 4-pole DIP switch on the rear panel of the rack shelf. There are up to 16 different addresses available to be assigned. When DIP switch in the "ON" position means logic "0"; when it is in the "OFF" position, meaning logic "1", for example, position 3 in "OFF", the corresponding bit, A2, is set to logic "1". Please refer to Table 3-1 for the detailed setup advice.



Module No.	Device address			
	A0	A1	A2	A3
	DIP switch position			
	1	2	3	4
0	ON	ON	ON	ON
1	OFF	ON	ON	ON
2	ON	OFF	ON	ON
3	OFF	OFF	ON	ON
4	ON	ON	OFF	ON
5	OFF	ON	OFF	ON
6	ON	OFF	OFF	ON
7	OFF	OFF	OFF	ON

Module No.	Device address			
	A0	A1	A2	A3
	DIP switch position			
	1	2	3	4
8	ON	ON	ON	OFF
9	OFF	ON	ON	OFF
10	ON	OFF	ON	OFF
11	OFF	OFF	ON	OFF
12	ON	ON	OFF	OFF
13	OFF	ON	OFF	OFF
14	ON	OFF	OFF	OFF
15	OFF	OFF	OFF	OFF

Table 3-1

### 3.19.2 PMBus Command List

© The command list of the DRP-3200 is shown in Table 3-2. It is compliant with the standard protocol of PMBus Rev. 1.1. For more detailed information, please refer to PMBus official website (<http://pmbus.org/specs.html>).

Command Code	Command Name	Transaction Type	# of data Bytes	Description
01h	OPERATION	R/W Byte	1	Remote ON/OFF control
02h	ON_OFF_CONFIG	Read Byte	1	ON/OFF function configuration
19h	CAPABILITY	Read Byte	1	Capabilities of a PMBus device
20h	VOUT_MODE	R Byte	1	Define data format for output voltage (format: Linear, N= -9)
21h	VOUT_COMMAND	R Word	2	Output voltage setting value (format: Linear, N= -9)
22h	VOUT_TRIM	R/W Word	2	Output voltage trimmed value (format: Linear, N= -9)
46h	IOUT_OC_FAULT_LIMIT	R/W Word	2	Output overcurrent setting value (format: Linear, N= -2)
47h	IOUT_OC_FAULT_RESPONSE	R Byte	1	Define protection and response when an output overcurrent fault occurred
79h	STATUS_WORD	R Word	2	Summary status reporting
7Ah	STATUS_VOUT	R Byte	1	Output voltage status reporting
7Bh	STATUS_IOUT	R Byte	1	Output current status reporting
7Ch	STATUS_INPUT	R Byte	1	AC input voltage status reporting
7Dh	STATUS_TEMPERATURE	R Byte	1	Temperature status reporting
7Eh	STATUS_CML	R Byte	1	Communication, logic, Memory status reporting
80h	STATUS_MFR_SPECIFIC	R Byte	1	Manufacture specific status reporting
81h	STATUS_FANS_1_2	R Byte	1	Fan1 and 2 status reporting
88h	READ_VIN	R Word	2	AC input voltage reading value (format: Linear, N=-1)
8Bh	READ_VOUT	R Word	2	Output voltage reading value (format: Linear, N= -9)
8Ch	READ_IOUT	R Word	2	Output current reading value (format: Linear, N= -2)
8Dh	READ_TEMPERATURE_1	R Word	2	Temperature 1 reading value (format: Linear, N= -3)
90h	READ_FAN_SPEED_1	R Word	2	Fan speed 1 reading value (format: Linear, N= 5)
91h	READ_FAN_SPEED_2	R Word	2	Fan speed 2 reading value (format: Linear, N= 5)
98h	PMBUS_REVISION	R Byte	1	The compliant revision of the PMBus (default: 11h for Rev. 1.1)
99h	MFR_ID	Block Read	12	Manufacturer's name
9Ah	MFR_MODEL	Block Read	12	Manufacturer's model name
9Bh	MFR_REVISION	Block Read	6	Firmware revision
9Ch	MFR_LOCATION	Block R/W	3	Manufacturer's factory location
9Dh	MFR_DATE	Block R/W	6	Manufacture date. (format: YYMMDD)
9Eh	MFR_SERIAL	Block R/W	12	Product serial number

Table 3-2

### 3.19.3 PMBus Data Range and Tolerance

◎ Display parameters

PMBus command	Model	Range	Tolerance
READ_VIN	ALL	80 ~ 264V	±10V
READ_VOUT	24V	0 ~ 30V	±0.36V
	48V	0 ~ 60V	±0.48V
READ_IOUT (Note. 1)	24V	0 ~ 160A	±5.32A
	48V	0 ~ 80A	±2.68A
READ_TEMPERATURE_1	ALL	-40 ~ 100°C	±5°C
READ_FAN_SPEED_1	ALL	0 ~ 25000RPM	±2000RPM
READ_FAN_SPEED_2	ALL	0 ~ 25000RPM	±2000RPM

Table 3-3

◎ Control parameters

PMBus command	Model	Adjustable range	Tolerance	Default
OPERATION	ALL	00h(OFF) / 80h(ON)	N/A	80h(ON)
VOUT_COMMAND (Note. 2)	24V	24V	N/A	24V
	48V	48V	N/A	48V
VOUT_TRIM (Note. 2)	24V	-12 ~ 6V	±0.36V	0V
	48V	-24 ~ 12V	±0.48V	0V
IOUT_OC_FAULT_LIMIT	24V	26.75 ~ 146.25A	±5.32A	146.25A
	48V	13.5 ~ 73.5A	±2.68A	73.5A

Table 3-4

Note:

1. READ\_IOUT will display ZERO amp when output current is less than values in the table below.

Model	Minimum readable current
24V	5.3A±1A
48V	2.7A±1A

Table 3-5

2. When using PMBus to adjust output voltage, VOUT\_COMMAND only can be used to display the rated voltage of the unit and cannot be written. It is VOUT\_TRIM that sets the rating of trimmed voltage. Taking DRP-3200-24 as an example, to get a 12V output, please set value of VOUT\_TRIM to -12V. Adjustable voltage range for each model is shown as below.

Model	Adjustable voltage
24V	12 ~ 30V
48V	24 ~ 60V

Table 3-6

### 3.20 DBR-3200 PMBus Communication Interface

- ◎ DBR-3200 is compliant with PMBus Rev.1.1, the maximum communication speed is 100KHz and it has the capability of identifying up to 8 addressed units.
- ◎ PMBus communication interface is able to provide the current operating status and data as the following:
  1. Output voltage, current and internal temperature.
  2. Alarm and status.
  3. Manufacturers and model data.
  4. Read/write on charge curve settings.



### 3.2.0.1 PMBus Device Addressing and Charge Mode Selection

Each DBR-3200 unit should have their unique and own device address to communicate over the PMBus. 7-bit address setting pins are used to assign a device address for a DBR-3200 unit, as shown in the below description.

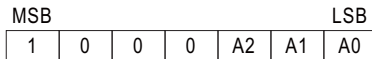

A0-A2 allow users to designate the address for each DBR-3200 unit; these three bits are defined through a 4-pole DIP switch on the rear panel of the rack shelf. There are up to 8 different addresses are available to be assigned. Please refer to Table 3-7(left) for the detailed setup advice.



\* The charging operation can be determined by the setup over D0, position 4 on the DIP switch. When D0 is "ON", DBR-3200 follows a built charging curve to charge the batteries; when D0 is "OFF", the charging operation is completely defined by the control over PMBus, PV/PC or SVR. Please refer to Table 3-7 (right).

Module No.	Device address		
	A0	A1	A2
	DIP switch position		
	1	2	3
0	ON	ON	ON
1	OFF	ON	ON
2	ON	OFF	ON
3	OFF	OFF	ON
4	ON	ON	OFF
5	OFF	ON	OFF
6	ON	OFF	OFF
7	OFF	OFF	OFF

D0	Function describe
DIP switch position 4	
ON	Charging curve
OFF	PMBus or PV/PC or SVR control

Table 3-7

### 3.2.0.2 Charge Curve

When it is opted for charging curve, D0 set to ON, charging curve function is enabled with additional PMBus commands. There are 4 built-in charging curves, "default" curve, one pre-defined curve for "gel battery", one pre-defined curve for "flooded battery" and one pre-defined curve for "AGM battery". Each curve can be selected by Command B4h CURVE\_CONFIG. Please refer to Table 3-8. In addition, users are able to customize their own charge curves, which will be stored to "default" after modification. Vboost can be set by Command B1h CURVE\_VBST ; Vfloat can be set by Command B2h CURVE\_VFLOAT ; Charge current level of stage1 can be set by Command B0h CURVE\_ICHG; Taper current level from stage2 to stage3 can be set by Command B3h CURVE\_ITAPER. Please refer to the following PMBus Command List in 3.2.0.4 for detailed information on commands and parameters.

#### ☉ Default 3 stage charging curve

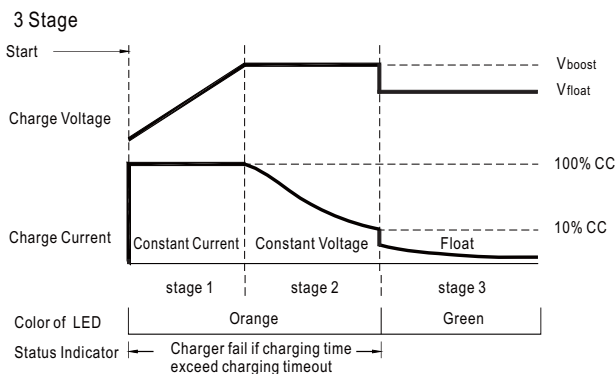

☉ Suitable for lead-acid batteries (flooded, Gel and AGM) and Li-ion batteries (lithium iron and lithium manganese).

Figure 3-10

#### ☉ Embedded 3 stage charging curve

MODEL	Description	Vboost	Vfloat	CC (default)
24V	Default, programmable	28.8	27.6	110A
	Pre-defined gel battery	28	27.2	
	Pre-defined flooded battery	28.4	26.8	
	Pre-defined AGM battery	29	27	
48V	Default, programmable	57.6	55.2	55A
	Pre-defined gel battery	56	54.4	
	Pre-defined flooded battery	56.8	53.6	
	Pre-defined AGM battery	58	54	

Table 3-8

Note:

When using this charger unit, please configured the system with recommended battery capacity by specification defined. Should battery capacity in use be much smaller so that user needs to set a low current for charging, under such condition it might cause higher current ripple.

NOTE: 1.The updated charging parameters are saved into EEPROM. The updated charging curve takes effect after DBR-3200 is restarted.  
2.When charging curve is enabled, the following commands will be invalid while other PMBus commands are effective: Command 01h OPERATION (regarding Remote ON-OFF function), Command 22h VOUT\_TRIM (regarding Output voltage programming function) and Command 46h IOUT\_OC\_FAULT\_LIMIT (regarding Output current programming function).

### 3.20.3 PMBUS, PV/PC or SVR Functions

Users are able to fully control and design the entire charging behavior, without the charging curve, by one of the following means- PMBus command, PV/PC function or SVR adjustment, please refer to the previous chapter. The operating priority is, PMBus > PV/PC > SVR.

NOTE: When operating in this mode, PMBus commands B0h/B1h...B8h can be set but there will be no response whereas other PMBus commands and functions work normally.

### 3.20.4 PMBus Command List

© The command list of the DBR-3200 is shown in Table 3-9. It is compliant with the standard protocol of PMBus Rev. 1.1. For more detailed information, please refer to PMBus official website (<http://pmbus.org/specs.html>).

Table 3-9

Command Code	Command Name	Transaction Type	# of data Bytes	Description
01h	OPERATION	R/W Byte	1	Remote ON/OFF control
02h	ON_OFF_CONFIG	Read Byte	1	ON/OFF function configuration
19h	CAPABILITY	Read Byte	1	Capabilities of a PMBus device
20h	VOUT_MODE	R Byte	1	Define data format for output voltage (format: Linear, N= -9)
21h	VOUT_COMMAND	R Word	2	Output voltage setting value (format: Linear, N= -9)
22h	VOUT_TRIM	R/W Word	2	Output voltage trimmed value (format: Linear, N= -9)
46h	IOUT_OC_FAULT_LIMIT	R/W Word	2	Output overcurrent setting value (format: Linear, N= -2)
47h	IOUT_OC_FAULT_RESPONSE	R Byte	1	Define protection and response when an output overcurrent fault occurred
79h	STATUS_WORD	R Word	2	Summary status reporting
7Ah	STATUS_VOUT	R Byte	1	Output voltage status reporting
7Bh	STATUS_IOUT	R Byte	1	Output current status reporting
7Ch	STATUS_INPUT	R Byte	1	AC input voltage status reporting
7Dh	STATUS_TEMPERATURE	R Byte	1	Temperature status reporting
7Eh	STATUS_CML	R Byte	1	Communication, logic, Memory status reporting
80h	STATUS_MFR_SPECIFIC	R Byte	1	Manufacture specific status reporting
81h	STATUS_FANS_1_2	R Byte	1	Fan1 and 2 status reporting
88h	READ_VIN	R Word	2	AC input voltage reading value (format: Linear, N=-1)
8Bh	READ_VOUT	R Word	2	Output voltage reading value (format: Linear, N= -9)
8Ch	READ_IOUT	R Word	2	Output current reading value (format: Linear, N= -2)
8Dh	READ_TEMPERATURE_1	R Word	2	Temperature 1 reading value (format: Linear, N= -3)
90h	READ_FAN_SPEED_1	R Word	2	Fan speed 1 reading value (format: Linear, N= 5)
91h	READ_FAN_SPEED_2	R Word	2	Fan speed 2 reading value (format: Linear, N= 5)
98h	PMBUS_REVISION	R Byte	1	The compliant revision of the PMBus (default: 11h for Rev. 1.1)
99h	MFR_ID	Block Read	12	Manufacturer's name
9Ah	MFR_MODEL	Block Read	12	Manufacturer's model name
9Bh	MFR_REVISION	Block Read	6	Firmware revision
9Ch	MFR_LOCATION	Block R/W	3	Manufacturer's factory location
9Dh	MFR_DATE	Block R/W	6	Manufacture date. (format: YYMMDD)
9Eh	MFR_SERIAL	Block R/W	12	Product serial number

Valid when charging according to charge curve(Do=ON)

Command Code	Command Name	Transaction Type	# of data Bytes	Description
B0h	CURVE_ICHG	R/W Word	2	Constant current setting value of charging curve (format: Linear, N= -2)
B1h	CURVE_VBST	R/W Word	2	Constant voltage setting value of charging curve (format: Linear, N= -9)
B2h	CURVE_VFLOAT	R/W Word	2	Constant voltage setting value of charging curve (format: Linear, N= -9)
B3h	CURVE_ITAPER	R/W Word	2	Taper current setting value of charging curve (format: Linear, N= -2)
B4h	CURVE_CONFIG	R/W Word	2	Configuration setting of charging curve
B5h	CURVE_CC_TIMEOUT	R/W Word	2	CC stage timeout setting value of charging curve (format: Linear, N= 0)
B6h	CURVE_CV_TIMEOUT	R/W Word	2	CV stage timeout setting value of charging curve (format: Linear, N= 0)
B7h	CURVE_FLOAT_TIMEOUT	R/W Word	2	Floating timeout setting value of charging curve (format: Linear, N= 0)
B8h	CHG_STATUS	READ Word	2	Charger's status reporting

Note :

⊙ Definition of Command B4h CURVE\_CONFIG :

	Bit7	Bit6	Bit5	Bit4	Bit3	Bit2	Bit1	Bit0
High byte	-	-	-	-	-	FVTOE	CVTOE	CCTOE
Low byte	-	STGS	-	-	TCS		CUVS	

Low byte

Bit 1-0 CUVS : Charge Curve Selecting

00= Customized Charge Curve (default)

01= Gel Battery

10= Flooded Battery

11= AGM Battery

Bit 3-2 TCS : Temperature Compensation Setting

00= disable

01= -3 mV/°C/cell (default)

10= -4 mV/°C/cell

11= -5 mV/°C/cell

Bit 6 STGS : 2/3 Stage Charge Setting

0= 3 stage charge (default, CURVE\_VBST and CURVE\_V FLOAT)

1= 2 stage charge (only CURVE\_VBST)

High byte

Bit 0 CCTOE : Constant Current Stage Timeout Indication Enable

0= disabled (default)

1= enabled

Bit 1 CVTOE : Constant Voltage Stage Timeout Indication Enable

0= disabled (default)

1= enabled

Bit 2 FVTOE : Float Voltage Stage Timeout Indication Enable

0= disabled (default)

1= enabled

© Definition of Command B8h CHG\_STATUS :

	Bit7	Bit6	Bit5	Bit4	Bit3	Bit2	Bit1	Bit0
High byte	FVTOF	CVTOF	CCTOF	-	BTNC	NTCER	-	EEPER
Low byte	-	-	-	-	FVM	CVM	CCM	FULLM

Low byte

Bit 0 FULLM : Fully Charged Mode Status

0=NOT fully charged

1=fully charged

Bit 1 CCM : Constant Current Mode Status

0=the charger NOT in constant current mode

1=the charger in constant current mode

Bit 2 CVM : Constant Voltage Mode Status

0=the charger NOT in constant voltage mode

1=the charger in constant voltage mode

Bit 3 FVM : Float Mode Status

0=the charger NOT in float mode

1=the charger in float mode

High byte

Bit 0 EEPER: EEPROM Charge Parameter Error

0=charge parameter correct

1=charge parameter error

Bit 2 NTCER: Temperature Compensation Status

0=NO short-circuit in the circuitry of temperature compensation

1=the circuitry of temperature compensation has short-circuited

Bit 3 BTNC: Battery Detection

0=battery detected

1=NO battery detected

Bit 5 CCTOF : Time Out Flag Of Constant Current Mode

0=NO time out in constant current mode

1=constant current mode timed out

Bit 6 CVTOF : Time Out Flag Of Constant Voltage Mode

0=NO time out in constant voltage mode

1=constant voltage mode timed out

Bit 7 FVTOF : Time Out Flag Of Float Mode

0=NO time out in float mode

1=float mode timed out

**Note:**

EEPER : When EEPROM Charge Parameter Error occurs, the charger stops charging the battery and the LED indicator turns red. The charger needs to re-power on to re-start charging the battery.

NTCER : When Temperature Compensation Short occurs, the charger output will shut down and the LED indicator will turn red. The charger will automatically restart after the Temperature Compensation Short condition is removed.

BTNC : When there is no battery detected, the charger stops charging the battery and the LED indicator turns red. The charger needs to re-power on to re-start charging the battery.

CCTOF : When timeout arises in the Constant Current stage, the charger stops charging the battery and the LED indicator turns red. The charger needs to re-power on to re-start charging the battery.

CVTOF : When timeout arises in the Constant Voltage stage, the charger stops charging the battery and the LED indicator turns red. The charger needs to re-power on to re-start charging the battery.

FVTOF : When timeout arises in the Float stage, the charger stops charging the battery and the LED indicator turns green. This charging flow is finished; the charger needs to re-power on to start charging a different battery.

### 3.20.5 PMBus Data Range and Tolerance

#### ◎ Display parameters

PMBus command	Mode	Range	Tolerance
READ_VIN	ALL	80 ~ 264V	±10V
READ_VOUT	24V	0 ~ 30V	±0.36V
	48V	0 ~ 60V	±0.48V
READ_IOUT (Note. 1)	24V	0 ~ 160A	±5.32A
	48V	0 ~ 80A	±2.68A
READ_TEMPERATURE_1	ALL	-40 ~ 100°C	±5°C
READ_FAN_SPEED_1	ALL	0 ~ 25000RPM	±2000RPM
READ_FAN_SPEED_2	ALL	0 ~ 25000RPM	±2000RPM

Tabel 3-10

#### ◎ Control parameter

PMBus command	Model	Adjustable range	Tolerance	Default
OPERATION	ALL	00h(OFF) / 80h(ON)	N/A	80h(ON)
VOUT_COMMAND (Note. 2)	24V	24V	N/A	24V
	48V	48V	N/A	48V
VOUT_TRIM (Note. 2)	24V	-6 ~ 6V	±0.36V	0V
	48V	-12 ~ 12V	±0.48V	0V
CURVE_VBST (Note. 3)	24V	18 ~ 30V	±0.36V	28.8V
	48V	36 ~ 60V	±0.48V	57.6V
CURVE_VFLOAT (Note. 3)	24V	18 ~ VBST	±0.36V	27.6V
	48V	36 ~ VBST	±0.48V	55.2V
IOUT_OC_FAULT_LIMIT CURVE_ICHG	24V	22 ~ 110A	±5.32A	110A
	48V	11 ~ 55A	±2.68A	55A
CURVE_ITAPER	24V	5.5A ~ 33A	±5.32A	11A
	48V	3A ~ 16.5A	±2.68A	5.5A
CURVE_CC_TIMEOUT CURVE_CV_TIMEOUT CURVE_FLOAT_TIMEOUT	ALL	60 ~ 64800 Minute	±5 Minute	600 Minute

Tabel 3-11

#### Note:

1. READ\_IOUT will display ZERO amp when output current is less than values in the table below.

Model	Minimum readable current
24V	5.3A±1A
48V	2.7A±1A

Tabel 3-12

2. When using PMBus to adjust output voltage, VOUT\_COMMAND only can be used to display the rated voltage of the unit and cannot be written. It is VOUT\_TRIM that provides voltage trimming function. Taking DBR-3200-24 as an example, to get a 18V output, please set value of VOUT\_TRIM to -6V. Adjustable voltage range for each model is shown as below.

Model	Adjustable voltage range
24V	18 ~ 30V
48V	36 ~ 60V

Tabel 3-13

3. The value of CURVE\_VFLOAT should be set less or equal to CURVE\_VBST, If CURVE\_VFLOAT is greater than CURVE\_VBST, it will be saved as CURVE\_VFLOAT = CURVE\_VBST in EEPROM.

☉ Please refer to our specifications about PV/PC or SVR function.

### 3.21 CANBus Communication Interface

☉ For further CANBus information, Please contact MEAN WELL for detail.

## 4. Notes on Operation

### 4.1 Installation Method

- ☉ Mount the DHP-1U in a 19 inch rack cabinet before operating.
- ☉ Insert 1 ~ 4 pieces of DRP/DBR-3200 (with the same output voltage and current) into the DHP-1U (refer to Figure 4-1)
- ☉ This is a unit with forced air cooling, please keep fans and ventilation holes free from any obstructions. It is suggested that there should be no barriers within 10cm of the ventilation holes.
- ☉ Connect AC source to the AC inlets (A, B, C, D) respectively.

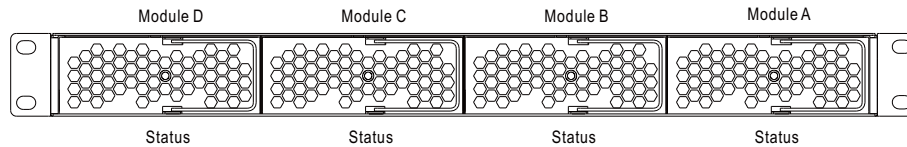

Figure 4-1 DHP System assembly diagram

☉ Suggested wire selection for input/out wirings, e.g. DRP-3200

Input/ Output	Module	Current	Minimum Cross-section of copper wire	Maximum Current
115VAC	1 unit	9Arms	14AWG UL1015	12A
230VAC	1 unit	17Arms	12AWG UL1015	22A
+24VDC	1 unit	133Adc	30mm <sup>2</sup>	139A
	2 unit	266Adc	100mm <sup>2</sup>	298A
	3 unit	399Adc	200mm <sup>2</sup>	469A
	4 unit	532Adc	250mm <sup>2</sup>	556A
+48VDC	1 unit	67Adc	22mm <sup>2</sup>	115A
	2 unit	134Adc	30mm <sup>2</sup>	139A
	3 unit	201Adc	60mm <sup>2</sup>	217A
	4 unit	268Adc	100mm <sup>2</sup>	298A
Other commonly used wires			16AWG UL1015	8A
			12AWG UL1015	22A
			10AWG UL1015	35A
			30mm <sup>2</sup>	139A
			50mm <sup>2</sup>	190A
			60mm <sup>2</sup>	217A
			80mm <sup>2</sup>	257A
			100mm <sup>2</sup>	298A
			125mm <sup>2</sup>	344A
			150mm <sup>2</sup>	395A
			200mm <sup>2</sup>	469A
			250mm <sup>2</sup>	556A
		325mm <sup>2</sup>	665A	

Table 4-1 Suggested wire selection for input/output wirings

#### 4.2 De-rating

⊙ When DRP-3200/DBR-3200 units are operating at a lower AC input voltage, these units will de-rate their output current automatically to protect themselves, shown as Figure 4-2.

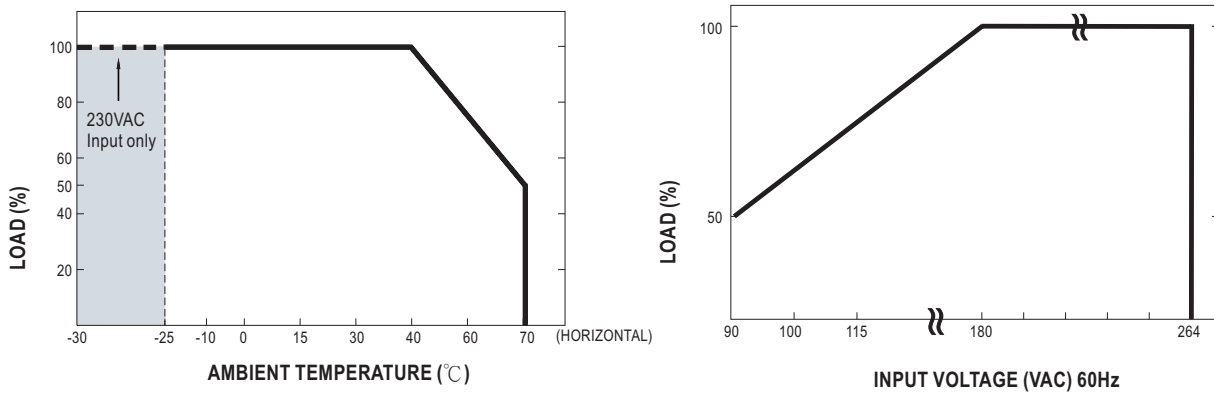

Figure 4-2 Output de-rating curves

#### 4.3 Warranty

⊙ A five year global warranty is provided under normal operation. Please do not change any component or modify the unit by yourself or MEANWELL may reserve the right not to provide the complete warranty service.