

atli

杭州腾力



Creaf Value For Customers



HANGZHOU ATLI AUTO ACCESSORIES CO.,LTD.



WX10



Cross Rim Wrench Fully Polished

Ref.No.	Specs. In.	Qty./ctn. Purchase.	G.W./N.W.Kg	Carton Size/cm
WX1014	14" φ14 x355	20	21/20	32x29x32
WX1014A	14" φ16 x355	20	25/24	32x29x34
WX1015	15" φ16 x380	20	26/25	34x31x34
WX1016	16" φ16 x406	20	27/26	36x32x34
WX1020	20" φ16 x500	20	34/33	43x39x34
WX1025	25" φ18 x635	12	33/32	55x50x24



WX11



Cross Rim Wrench Chrome Plated

Ref.No.	Specs. In.	Qty./ctn. Purchase.	G.W./N.W.Kg	Carton Size/cm
WX1107	7" φ12x180	50	19/18	30x19x32
WX1114	14" φ16 x355	20	25/24	32x29x34
WX1115	15" φ16 x380	20	26/25	34x31x34
WX1116	16" φ16 x406	20	27/26	36x32x34
WX1120	20" φ16 x500	20	34/33	43x39x34
WX1124	24" φ20 x610	10	35/34	56x49x23
WX1127	27 1/2" φ22 x700	6	28/27	58x56x18



WX12



Cross Rim Wrench With Plastic Pad

Ref.No.	Specs. In.	Qty./ctn. Purchase.	G.W./N.W.Kg	Carton Size/cm
WX1214	14" φ16 x355	20	26/25	34x29x34
WX1215	15" φ16 x380	20	27/26	37x31x36
WX1224	24" φ20 x610	10	36/35	56x49x23
WX1227	27 1/2" φ22 x700	6	28/27	60x56x17



WX13



Cross Rim Wrench Fully Polished

Ref.No.	Specs. In.	Qty./ctn. Purchase.	G.W./N.W.Kg	Carton Size/cm
WX1314	14" φ16 x355	20	26/25	34x29x34
WX1315	15" φ16 x380	20	27/26	36x31x34
WX1324	24" φ20 x610	10	36/35	56x50x23
WX1327	27 1/2" φ22 x700	6	28/27	60x56x17



WX14



Cross Rim Wrench Powder Coated

Ref.No.	Specs. In.	Qty./ctn. Purchase.	G.W./N.W.Kg	Carton Size/cm
WX1407	7" φ12 x180	50	19/18	30x19x32
WX1414	14" φ16 x355	20	25/24	32x29x34
WX1415	15" φ16 x380	20	26/25	34x31x34
WX1416	16" φ16 x400	20	27/26	36x32x34
WX1420	20" φ16 x500	20	34/33	43x39x34
WX1424	24" φ20 x610	10	35/34	56x49x23
WX1427	27 1/2" φ22 x700	6	28/27	58x56x18



WX15



Cross Rim Wrench With Plastic handle

Ref. No.	Specs. In.	Qty./ctn. Purchase	G.W./N.W.Kg	Carton Size/cm
WX1514	14" φ16 x355	20	26/25	33x30x34
WX1516	16" φ16 x355	20	28/27	37x32x34
WX1520	20" φ16 x355	20	33/32	43x39x34

GROSS RIM WRENCH



WX16



Cross Rim Wrench Fully Polished Anodized Colour

Ref. No.	Specs. In.	Qty./ctn. Purchase	G.W./N.W.Kg	Carton Size/cm
WX1616	16" φ16 x406	12	17/16	37x35x43
WX1620	20" φ16 x500	12	21/20	41x41x45



WX17



Cross Rim Wrench Fully Polished Knurling Handle

Ref. No.	Specs. In.	Qty./ctn. Purchase	G.W./N.W.Kg	Carton Size/cm
WX1714	14" φ16 x355	20	26/25	34x29x34
WX1715	15" φ16 x380	20	27/26	37x31x36
WX1716	16" φ16 x406	10	36/35	56x49x23
WX1720	20" φ16 x500	6	28/27	60x56x17



WX18



Cross Rim Wrench zinc plated

Ref. No.	Specs. In.	Qty./ctn. Purchase	G.W./N.W.Kg	Carton Size/cm
WX1814	14" φ16 x355	20	25/24	32x29x34
WX1815	15" φ16 x380	20	26/25	34x31x34
WX1816	16" φ16 x406	20	27/26	36x32x34
WX1820	20" φ16 x500	20	34/33	43x39x34



WX19

40CrV Cross Rim Wrench Satin Finished



Ref. No.	Specs. In.	Qty./ctn. Purchase	G.W./N.W.Kg	Carton Size/cm
WX1916	16" φ16 x406	20	28/27	36x32x34



WX20



Cross Rim Wrench With Dipped handle

Ref. No.	Specs. In.	Qty./ctn. Purchase	G.W./N.W.Kg	Carton Size/cm
WX2014	14" φ16x355	20	26/25	33x29x36
WX2016	16" φ16x406	20	28/27	37x32x36
WX2020	20" φ16x500	20	35/34	43x39x36



WX21



Cross Rim Wrench Silver Powder Coated

Ref. No.	Specs. In.	Qty./ctn. Purchase	G.W./N.W.Kg	Carton Size/cm
WX2114	14" φ16 x355	20	27/26	35x29x36
WX2115	15" φ16 x380	20	29/27	37x31x36
WX2124	24" φ20 x610	10	35/34	56x49x23
WX2127	27 1/2" φ22x700	6	29/27	55x55x26



WX22



Cross Rim Wrench Adjustable Type

Ref. No.	Specs. In.	Qty./ctn. Purchase	G.W./N.W.Kg	Carton Size/cm
WX2224	14" φ16x355	20	25/24	37x30x14



WX23



Cross Rim Wrench for Truck

Ref. No.	Specs. In.	Qty./ctn. Purchase	G.W./N.W.Kg	Carton Size/cm
WX2370	700mm	1	7/6	57x57x8



WX25



Ref. No.	Specs. In.	Qty./ctn. Purchase	G.W./N.W.Kg	Carton Size/cm
WX2514	14" φ16x355	20	27/26	38x31x16



WX24

Plastic Card

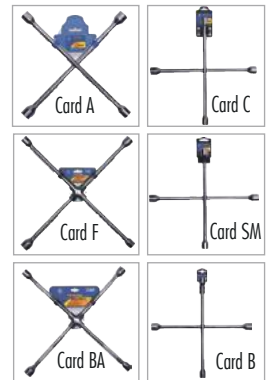

WL30



L-Type Wrench With Hole(sand-blasting)				
Ref. NO.	Specs. In.	Qty/Ctn. Pcs	G.W./N.W. Kg	Carton Size cm
WL3006	6	600	33/32	34×25×12
WL3007	7	500	30/29	24×26×14
WL3008	8	400	35/34	37×29×15
WL3009	9	300	29/28	32×25×18
WL3010	10	300	33/32	32×30×18
WL3011	11	280	40/39	33×30×19
WL3012	12	180	29/28	35×20×19
WL3013	13	160	30/29	35×20×20
WL3014	14	140	36/35	32×21×22
WL3015	15	100	31/30	26×22×23
WL3016	16	90	28/27	30×24×21
WL3017	17	80	30/29	31×26×18
WL3018	18	70	31/30	31×26×18
WL3019	19	70	34/33	31×27×19
WL3020	20	60	32/31	33×29×19
WL3021	21	60	33/32	33×29×19
WL3022	22	40	29/28	33×29×14
WL3023	23	40	30/29	34×30×14
WL3024	24	40	35/34	35×30×18
WL3025	25	30	32/31	37×31×21
WL3026	26	30	34/33	38×24×21
WL3027	27	24	35/34	35×28×19
WL3030	30	16	32/31	44×27×16
WL3032	32	16	35/34	45×27×17
WL3034	34	12	29/28	48×22×17
WL3036	36	12	33/32	54×29×11

L-TYPE WRENCH

WL32



L-TYPE WITH SCREWDRIVER				
Ref. NO.	Specs. In.	Qty/Ctn. Pcs.	G.W./N.W. Kg	Carton Size cm
WL3217	17	50	28/27	36×36×13
WL3219	19	50	29/28	36×36×13
WL3221	21	50	29/28	36×36×13

WL31



L-Type Wrench With Hole(full polished)				
Ref. NO.	Specs. In.	Qty/Ctn. Pcs	G.W./N.W. Kg	Carton Size cm
WL3106	6	600	33/32	34×25×12
WL3107	7	500	30/29	24×26×14
WL3108	8	400	35/34	37×29×15
WL3109	9	300	29/28	32×25×18
WL3110	10	300	33/32	32×30×18
WL3111	11	280	40/39	33×30×19
WL3112	12	180	29/28	35×20×19
WL3113	13	160	30/29	35×20×20
WL3114	14	140	36/35	32×21×22
WL3115	15	100	31/30	26×22×23
WL3116	16	90	28/27	30×24×21
WL3117	17	80	30/29	31×26×18
WL3118	18	70	31/30	31×26×18
WL3119	19	70	34/33	31×27×19
WL3120	20	60	32/31	33×29×19
WL3121	21	60	33/32	33×29×19
WL3122	22	40	29/28	33×29×14
WL3123	23	40	30/29	34×30×14
WL3124	24	40	35/34	35×30×18
WL3125	25	30	32/31	37×31×21
WL3126	26	30	34/33	38×24×21
WL3127	27	24	35/34	35×28×19
WL3130	30	16	32/31	44×27×16
WL3132	32	16	35/34	45×27×17
WL3134	34	12	29/28	48×22×17
WL3136	36	12	33/32	54×29×11

L-TYPE WRENCH

L-Type Wrench Special Type

Ref. No.	Specs. In.	Qty/ctn. Purchase	G.W./N.W.Kg	Carton Size/cm
WL3306	6mm	500	26/25	28x26x16
WL3307	7mm	500	28/27	30x27x16
WL3308	8mm	400	25/24	29x28x17
WL3309	9mm	300	23/22	30x25x19
WL3310	10mm	300	31/30	32x27x19
WL3311	11mm	200	28/27	32x21x20
WL3312	12mm	180	30/29	34x21x19
WL3313	13mm	160	28/27	35x18x22
WL3314	14mm	120	29/28	29x20x24
WL3315	15mm	100	24/23	26x22x26
WL3316	16mm	80	25/24	26x24x23
WL3317	17mm	80	24/23	27x24x22
WL3318	18mm	70	25/24	29x25x21
WL3319	19mm	70	29/28	29x26x21
WL3320	20mm	60	29/28	31x27x20
WL3321	21mm	50	30/29	30x29x18
WL3322	22mm	40	28/27	30x25x17
WL3323	23mm	40	29/28	30x26x19
WL3324	24mm	30	25/24	32x22x19
WL3325	25mm	24	25/24	32x22x19
WL3326	26mm	24	25/24	34x22x16
WL3327	27mm	20	25/24	36x16x21
WL3328	28mm	20	27/26	37x18x21
WL3330	30mm	16	25/24	39x18x18
WL3332	32mm	16	26/25	42x18x19

WL33



WL34



OEM Wrench

Ref. No.	Specs. In.	Qty/ctn. Purchase	G.W./N.W.Kg	Carton Size/cm
WL3421	21mm	1400	770/730	106x76x75
WL3419	19mm	60	21/20	36x31x17
WL3417	17mm	2000	840/800	106x80x52

WL35



L-Type Wrench Special Type

Ref. No.	Specs. In.	Qty/ctn. Purchase	G.W./N.W.Kg	Carton Size/cm
WL3514	14mm	60	23/22	31x31x13
WL3517	17mm	50	27/26	36x36x13
WL3519	19mm	50	28/27	36x36x13
WL3521	21mm	50	28/27	36x36x13
WL3522	22mm	50	29/28	37x37x13
WL3523	23mm	50	29/28	37x37x13
WL3524	24mm	50	29/28	37x37x13
WL3526	26mm	40	24/23	35x35x14
WL3527	27mm	40	31/30	36x36x14

L-TYPE WRENCH

WL36



L-Type Wrench With Hole

Ref. No.	Specs. In.	Qty/ctn. Purchase	G.W./N.W.Kg	Carton Size/cm
WL3606	6mm	600	31/32	34x24x19
WL3607	7mm	500	30/29	28x27x23
WL3608	8mm	400	34/33	31x30x17
WL3609	9mm	300	27/26	31x26x18
WL3610	10mm	300	32/31	31x30x19
WL3611	11mm	280	39/38	33x28x20
WL3612	12mm	180	28/27	35x22x19
WL3613	13mm	160	29/28	36x19x22
WL3614	14mm	140	35/34	33x21x24
WL3615	15mm	100	27/26	28x24x25
WL3616	16mm	90	27/26	29x25x24
WL3617	17mm	80	26/25	30x26x22
WL3618	18mm	70	28/27	32x28x20
WL3619	19mm	70	29/28	32x29x21
WL3620	20mm	60	27/26	34x30x19
WL3621	21mm	60	29/28	34x31x20
WL3622	22mm	40	21/20	33x30x18
WL3623	23mm	40	29/28	35x30x18
WL3624	24mm	40	29/28	36x30x19
WL3625	25mm	30	31/30	35x26x18
WL3626	26mm	30	33/32	37x25x19
WL3627	27mm	24	26/25	39x26x17
WL3629	29mm	16	29/28	41x20x18
WL3630	30mm	16	31/30	42x20x18
WL3632	32mm	16	34/33	45x22x19
WL3634	34mm	12	28/27	48x22x14
WL3636	36mm	12	32/31	50x24x15

L-Type Wrench Without Hole

Ref. No.	Specs. In.	Qty/ctn. Purchase	G.W./N.W.Kg	Carton Size/cm
WL3706	6mm	600	30/29	34x24x19
WL3707	7mm	500	30/29	28x27x23
WL3708	8mm	400	35/34	31x30x17
WL3709	9mm	300	33/32	31x26x18
WL3710	10mm	300	33/32	33x28x19
WL3711	11mm	280	35/34	33x28x20
WL3712	12mm	180	31/30	35x22x19
WL3713	13mm	160	31/30	36x19x22
WL3714	14mm	140	30/29	33x21x24
WL3715	15mm	100	30/29	28x24x25
WL3716	16mm	90	29/28	29x25x24
WL3717	17mm	80	28/27	30x26x22
WL3719	19mm	70	30/29	34x30x19
WL3721	21mm	60	29/28	33x30x18
WL3722	22mm	40	27/26	35x30x18
WL3723	23mm	40	28/27	36x30x19
WL3724	24mm	40	28/27	37x30x19
WL3727	27mm	30	28/27	40x24x16
WL3730	30mm	24	31/30	44x27x18
WL3732	32mm	20	32/31	45x20x22

WL37



- Heat Treated
- Drop Forged
- Chrome Plated
- Fully Polished



T-TYPE WRENCH



T-Type Wrench (short T-type)

WT40

Ref.No.	Specs. mm	Qty/ctn.Pcs	G.W./N.W.Kg	Carton Size/cm
WT4008	8	300	36/35	30×27×28
WT4009	9	195	31/30	34×33×17
WT4010	10	200	35/34	37×34×17
WT4011	11	200	35/34	37×34×17
WT4012	12	100	29/28	41×24×14
WT4013	13	100	29/28	41×25×19
WT4014	14	100	29/28	41×24×23
WT4015	15	100	30/29	41×24×23
WT4017	17	100	33/32	43×26×24
WT4019	19	100	38/37	44×26×26



Long T-type

WT41

Ref.No.	Specs. mm	Qty/ctn.Pcs	G.W./N.W.Kg	Carton Size/cm
WT4108	8	100	27/26	43×30×20
WT4109	9	100	27/26	43×30×20
WT4110	10	100	28/27	43×30×21
WT4111	11	100	29/28	43×30×21
WT4112	12	100	29/28	43×30×22
WT4113	13	100	29/28	43×30×22
WT4114	14	100	29/28	43×30×26
WT4117	17	100	42/41	44×30×32
WT4119	19	50	25/24	45×32×17



Long Socket T-Type

WT42

Ref.No.	Specs. In.	Qty/ctn. Purchase	G.W./N.W.Kg	Carton Size/cm
WT4206	6mm	100	25/24	36x32x23
WT4207	7mm	100	25/24	36x32x23
WT4208	8mm	100	25/24	36x32x23
WT4209	9mm	100	25/24	36x32x23
WT4210	10mm	100	25/24	36x32x23
WT4211	11mm	100	25/24	36x32x23
WT4212	12mm	100	25/24	36x32x23
WT4213	13mm	100	25/24	36x32x23
WT4214	14mm	100	25/24	36x32x23
WT4215	15mm	100	31/30	36x32x26
WT4216	16mm	100	31/30	36x32x26
WT4217	17mm	100	31/30	36x32x26
WT4218	18mm	100	31/30	36x32x26
WT4219	19mm	100	31/30	36x32x26

Peculiar Wrench

Speak Plug Wrench

WS60

Ref.No.	Specs. In.	Qty/ctn. Purchase	G.W./N.W.Kg	Carton Size/cm
WS6016	16	60	29/28	59×33×29
WS6021	21	60	34/33	60×33×26





WY51

Y-Type Wrench

Ref. No.	Specs. In.	Qty./ctn. Purchase	G.W./N.W.Kg	Carton Size/cm
WY5110	8x9x10	160	27/26	33x31x28
WY5113	9x11x13	180	34/33	37x33x35
WY5113A	10x11x13	180	34/33	37x33x35
WY5114	10x12x14	160	34/29	33x35x29
WY5117	10x14x17	110	30/29	39x35x23
WY5117A	12x14x17	110	32/31	41x36x23

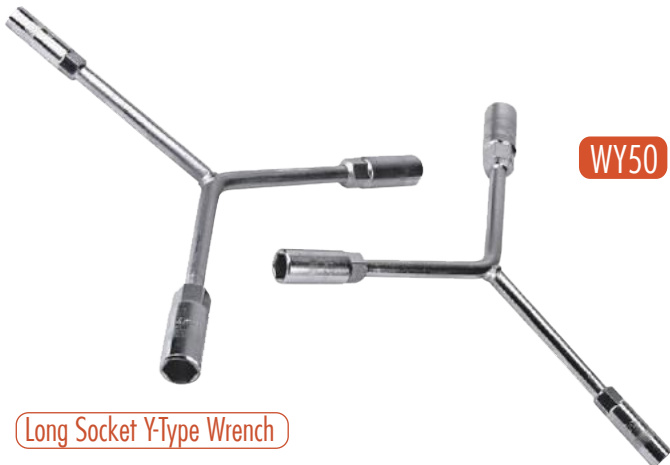

WY50

Long Socket Y-Type Wrench

Ref. No.	Specs. In.	Qty./ctn. Purchase	G.W./N.W.Kg	Carton Size/cm
WY5010	8x9x10	100	26/25	36x32x26
WY5012	8x10x12	100	26/25	36x32x26
WY5014	10x12x14	100	26/25	36x32x26
WY5017	12x14x17	80	30/29	36x32x26
WY5019	14x17x19	80	30/29	36x32x26

PECULIAR WRENCH



WX26

TIRE WRENCH

Handle specification :

WX2614 14"/350mm
WX2616 16"/400mm
WX2618 18"/450mm
WX2620 20"/500mm

Sleeve specification:

17x19mm
21x23mm



WX36 Socket Wrench With Bar



Socket wrench wire size:

22mm/23mm/25mm/28mm

Socket wrench Length:

300mm/320mm/350mm
/400mm/410mm

Crowbar Size:

18/19/20/21mm,350/400mm

Socket Size

- 17x41
- 19x41
- 20x38
- 21x38
- 21x41
- 22x24
- 22x38
- 22x41
- 24x27
- 27x30
- 27x32
- 27x33
- 28x33
- 30x32
- 30x33
- 32x33
- 32x36
- 33x36
- 33x38
- 35x38
- 36x38

WX35 Heavy Duty Socket Wrench With Bar

Ref. No.	Specs. In.	Qty./ctn. Purchase	G.W./N.W.Kg	Carton Size/cm
WX3507	6x7	500	23/22	34x27x15
WX3509	8x9	400	25/24	27x22x27
WX3511	10x11	300	27/26	30x25x23
WX3513	12x13	150	23/22	33x28x14
WX3515	14x15	150	23/22	37x30x16
WX3517	16x17	120	25/24	37x28x17
WX3519	18x19	120	30/39	38x30x19
WX3522	20x22	80	25/24	33x21x26
WX3523	21x23	80	27/26	34x22x28
WX3526	24x26	60	26/25	38x23x24
WX3528	25x28	50	26/25	59x24x17
WX3529	27x29	40	21/20	43x25x18
WX3532	30x32	30	23/22	25x23x28



WX27

TIRE WRENCH

Handle specification Sleeve specification

WX2716 16"/400mm 17x19mm
WX2718 18"/450mm 21x23mm





WX28

WX2816	
Specification	16"
Volume	53x33x27cm
G.W/N.W	26.5/27kg



WX29

WX2916	
Specification	16"
Volume	53x33x27cm
G.W/N.W	26.5/27kg



TIRE WRENCH



WX30

WX3016	
Specification	16"
Volume	53x33x27cm
G.W/N.W	26.5/27kg



RETRACTABLE TIRE WRENCH WL39



WL38 RETRACTABLE TIRE WRENCH



WL3800

- Forging the sleeve USES the cr-v material;
- Fine polishing,use more comfortable appearance;
- Electroplating processing;
- All kinds material order.

Range of application :
380-500mm (Length can be customized)
φ19mm-21mm

Packing quantity : 20 or 50pcs

WL3900

- Forging the sleeve USES the cr-v material;
- Fine polishing,use more comfortable appearance;
- Electroplating processing;
- All kinds material order.

Range of application :
380-500mm (Length can be customized)
φ19mm-21mm

Packing quantity : 20 or 50pcs



TORQUE WRENCH

WS62

<ul style="list-style-type: none"> • Forging the sleeve USES the cr-v material; • Fine polishing, use more comfortable appearance; • Electroplating processing; • All kinds material order. 	WS6200	
	Specification	0-300N.m(1/2)
	Volume	54x48x30cm
	G.W/N.W	1.014/1.115
	Packing quantity	20pcs



WS63

<ul style="list-style-type: none"> • Forging the sleeve USES the cr-v material; • Fine polishing, use more comfortable appearance; • Electroplating processing; • All kinds material order. 	WS6300	
	Specification	0-500N.m(3/4)
	Volume	58x33x30cm
	G.W/N.W	1.536/1.675
	Packing quantity	20pcs

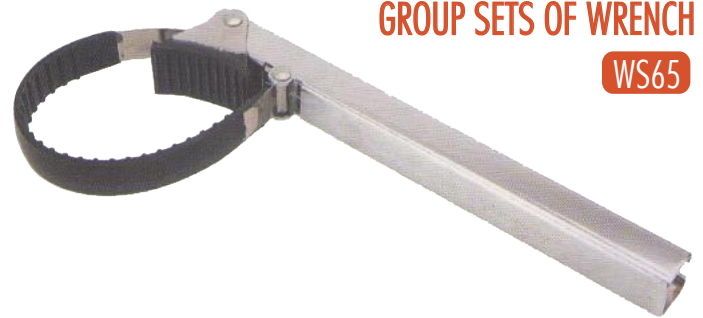

GROUP SETS OF WRENCH

WS65

Art.No.	Range of application	Handle length	Weight	Packing size	Packing quantity
WS6501	φ65-φ140mm	10"	390g	47x45x20cm	50pcs



WS66

Engine set wrench

Art.No.	Range of application	Handle length	Weight	Packing size	Packing quantity
WS6601	φ65-φ120mm	8"	330g	47x36x20cm	50pcs
WS6602	φ76-φ125mm				
WS6603	φ76-φ135mm				

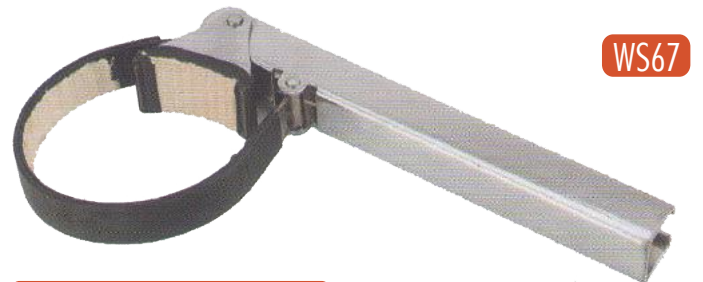

WS67

Porous adjustable canvas wrench

Art.No.	Range of application	Handle length	Weight	Packing size	Packing quantity
WS6701	φ65-φ120mm	8"	330g	47x36x20cm	50pcs
WS6702	φ76-φ125mm				
WS6703	φ76-φ135mm				

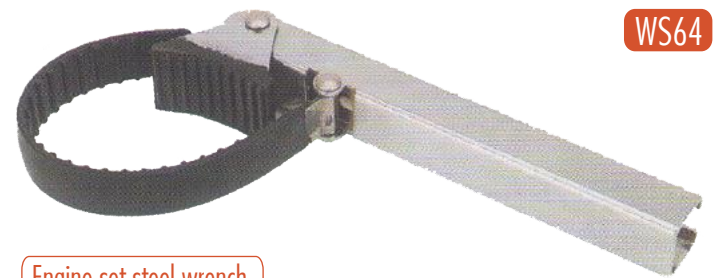

WS64

Engine set steel wrench

Art.No.	Range of application	Handle length	Weight	Packing size	Packing quantity
WS6400	φ65-φ105mm	6"	220g	54x48x30cm	100pcs

Farmland work machine set steel band spanner

Art.No.	Range of application	Handle length	Weight	Packing size	Packing quantity
WS6800	φ65-φ110mm	10"	230g	45x35x35cm	50pcs



WS68

LABOR SAVING WRENCH



WK7581

Trans-speed ratio	1:58
Max torque output	>5000N.M
Drive square	1"
Weight	13kg
Material	40Cr
Sockets	1-8pcs

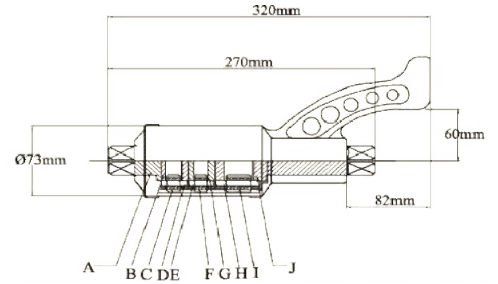

Code name	A	B	C	D	E	F	G	H	I	J
Name	Main input shaft	2-stage input	H17 Gear	Pin	Pin	H17 Gear	3-stage input	Pin	H25 Gear	Output shaft
Quantity	1	1	3	3	3	3	1	3	3	1
Gear modulus	2.0	2.0	2.0			2.0	2.0		2.0	



WK7582

Trans-speed ratio	1:58
Max torque output	>4800N.M
Drive square	1"
Weight	7.5kg
Material	40Cr
Sockets	1-4pcs

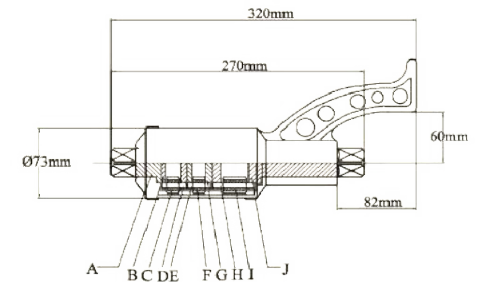

Code name	A	B	C	D	E	F	G	H	I	J
Name	Main input shaft	2-stage input	H17 Gear	Pin	Pin	H17 Gear	3-stage input	Pin	H25 Gear	Output shaft
Quantity	1	1	3	3	3	3	1	3	3	1
Gear modulus	2.0	2.0	2.0			2.0	2.0		2.0	



WK7583

Trans-speed ratio	1:58
Max torque output	>5000N.M
Drive square	1"
Weight	8.5kg
Material	40Cr
Sockets	1-4pcs

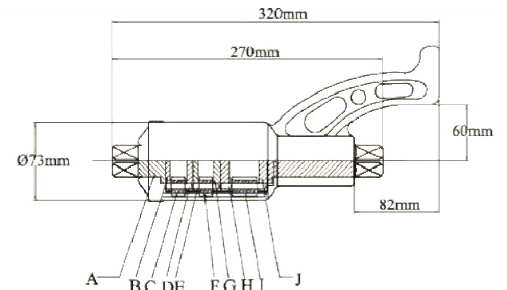

Code name	A	B	C	D	E	F	G	H	I	J
Name	Main input shaft	2-stage input	H17 Gear	Pin	Pin	H17 Gear	3-stage input	Pin	H25 Gear	Output shaft
Quantity	1	1	3	3	3	3	1	3	3	1
Gear modulus	2.0	2.0	2.0			2.0	2.0		2.0	



WK7584

Trans-speed ratio	1:58
Max torque output	>4800N.M
Drive square	1"
Weight	8kg
Material	40Cr
Sockets	1-4pcs

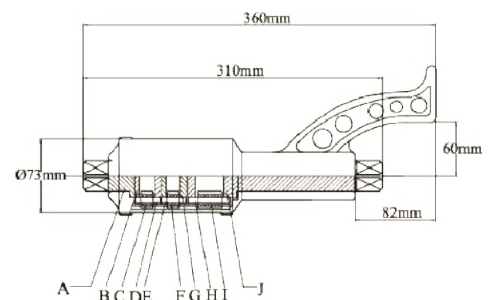

Code name	A	B	C	D	E	F	G	H	I	J
Name	Main input shaft	2-stage input	H17 Gear	Pin	Pin	H17 Gear	3-stage input	Pin	H25 Gear	Output shaft
Quantity	1	1	3	3	3	3	1	3	3	1
Gear modulus	2.0	2.0	2.0			2.0	2.0		2.0	

LABOR SAVING WRENCH

WK7681

Trans-speed ratio	1:68
Max torque output	>6200N.M
Drive square	1"
Weight	8kg
Material	40Cr
Sockets	1-4pcs

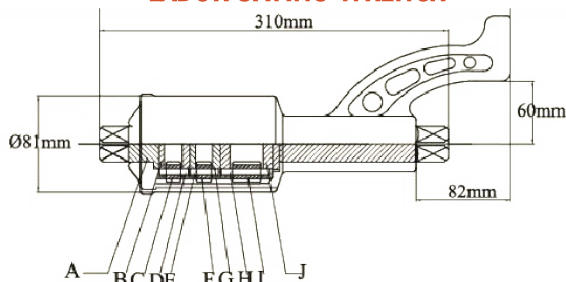

Code name	A	B	C	D	E	F	G	H	I	J
Name	Main input shaft	2-stage input	H17 Gear	Pin	Pin	H17 Gear	3-stage input	Pin	H25 Gear	Output shaft
Quantity	1	1	3	3	3	3	1	3	3	1
Gear modulus	2.5	2.5	2.5			2.5	2.5		2.5	



WK7682

Trans-speed ratio	1:68
Max torque output	>6200N.M
Drive square	1"
Weight	8kg
Material	40Cr
Sockets	1-4pcs

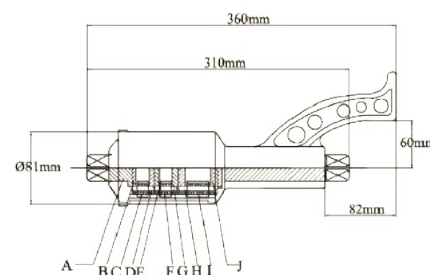

Code name	A	B	C	D	E	F	G	H	I	J
Name	Main input shaft	2-stage input	H17 Gear	Pin	Pin	H17 Gear	3-stage input	Pin	H25 Gear	Output shaft
Quantity	1	1	3	3	3	3	1	3	3	1
Gear modulus	2.5	2.5	2.5			2.5	2.5		2.5	



WK7783

Trans-speed ratio	1:78
Max torque output	>7500N.M
Drive square	1"
Weight	9.5kg
Material	40Cr
Sockets	1-4pcs

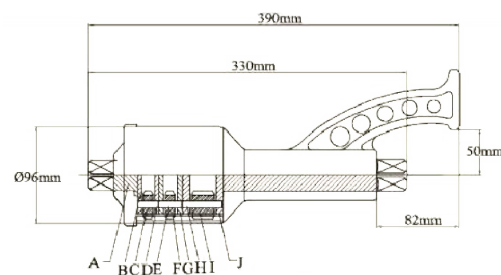

Code name	A	B	C	D	E	F	G	H	I	J
Name	Main input shaft	2-stage input	H17 Gear	Pin	Pin	H17 Gear	3-stage input	Pin	H25 Gear	Output shaft
Quantity	1	1	4	4	4	4	1	4	4	1
Gear modulus	3.0	3.0	3.0			3.0	3.0		3.0	



WK7645

Trans-speed ratio	1:64/1:4.2/1:1
Max torque output	>6800N.M
Drive square	1"
Weight	9.5kg
Material	40Cr
Sockets	1-4pcs

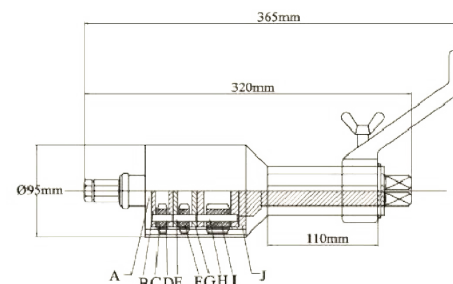

Code name	A	B	C	D	E	F	G	H	I	J
Name	Main input shaft	2-stage input	H17 Gear	Pin	Pin	H17 Gear	3-stage input	Pin	H25 Gear	Output shaft
Quantity	1	1	4	4	4	4	1	4	4	1
Gear modulus	3.0	3.0	3.0			3.0	3.0		3.0	



LABOR SAVING WRENCH



WK7161

Trans-speed ratio	1:16
Max torque output	>800N.M
Drive square	1/2"
Weight	2kg
Material	40Cr
Sockets	3pcs

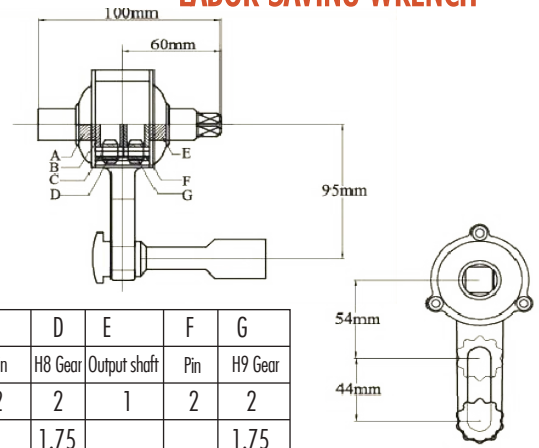

Code name	A	B	C	D	E	F	G
Name	Main input shaft	2-stage input	Pin	H8 Gear	Output shaft	Pin	H9 Gear
Quantity	1	1	2	2	1	2	2
Gear modulus	1.75	1.75		1.75			1.75



WK7162

Trans-speed ratio	1:16
Max torque output	>800N.M
Drive square	1/2"
Weight	2kg
Material	40Cr
Sockets	3pcs

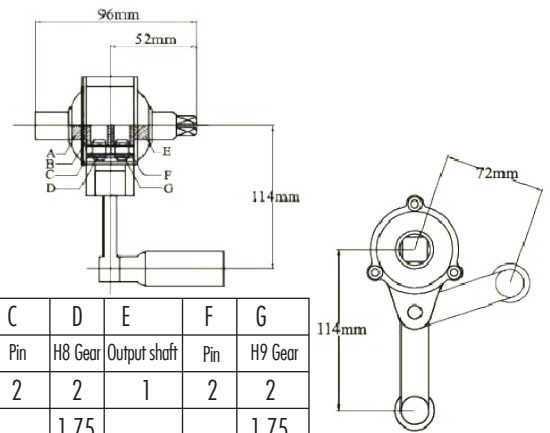

Code name	A	B	C	D	E	F	G
Name	Main input shaft	2-stage input	Pin	H8 Gear	Output shaft	Pin	H9 Gear
Quantity	1	1	2	2	1	2	2
Gear modulus	1.75	1.75		1.75			1.75



WK7641

Trans-speed ratio	1:64
Max torque output	>5500N.M
Drive square	1"
Weight	8.5kg
Material	40Cr
Sockets	1-4pcs

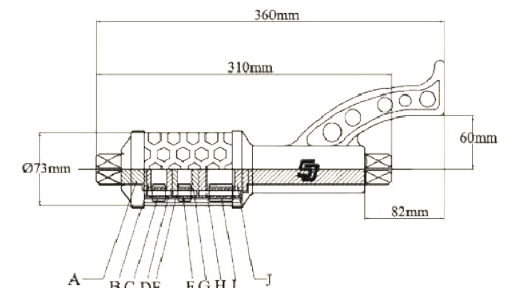

Code name	A	B	C	D	E	F	G	H	I	J
Name	Main input shaft	2-stage input	H17 Gear	Pin	Pin	H17 Gear	3-stage input	Pin	H25 Gear	Output shaft
Quantity	1	1	3	3	3	3	1	3	3	1
Gear modulus	2.5	2.5	2.5			2.5	2.5		2.5	



WK7642

Trans-speed ratio	1:64
Max torque output	>5500N.M
Drive square	1"-3/4"
Weight	8kg
Material	40Cr
Sockets	1-4pcs

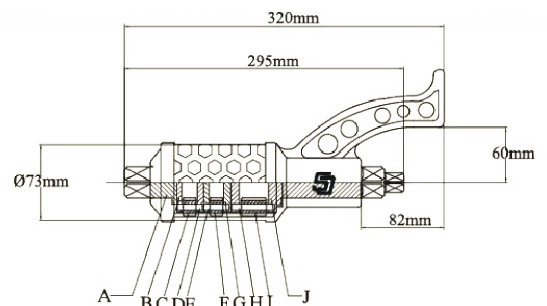

Code name	A	B	C	D	E	F	G	H	I	J
Name	Main input shaft	2-stage input	H17 Gear	Pin	Pin	H17 Gear	3-stage input	Pin	H25 Gear	Output shaft
Quantity	1	1	3	3	3	3	1	3	3	1
Gear modulus	2.5	2.5	2.5			2.5	2.5		2.5	



WK7646

Trans-speed ratio	1:64/1:4.2/1:1
Max torque output	>6800N.M
Drive square	1"
Weight	12kg
Material	40Cr
Sockets	1-5pcs

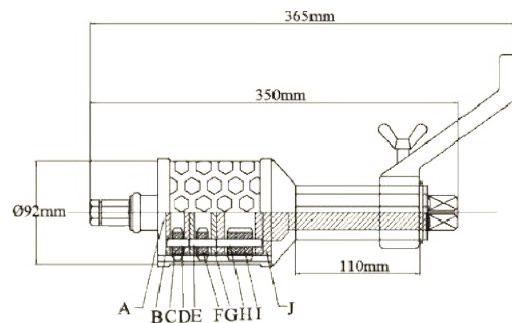

Code name	A	B	C	D	E	F	G	H	I	J
Name	Main input shaft	2-stage input	H17 Gear	Pin	Pin	H17 Gear	3-stage input	Pin	H25 Gear	Output shaft
Quantity	1	1	4	4	4	4	1	4	4	1
Gear modulus	3.0	3.0	3.0			3.0	3.0		3.0	



WK7643

Trans-speed ratio	1:64
Max torque output	>5500N.M
Drive square	1" 3/4"
Weight	8kg
Material	40Cr
Sockets	1-4pcs

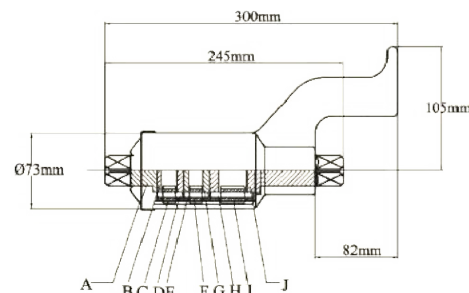

Code name	A	B	C	D	E	F	G	H	I	J
Name	Main input shaft	2-stage input	H17 Gear	Pin	Pin	H17 Gear	3-stage input	Pin	H25 Gear	Output shaft
Quantity	1	1	3	3	3	3	1	3	3	1
Gear modulus	2.5	2.5	2.5			2.5	2.5		2.5	



WK7683

Trans-speed ratio	1:68
Max torque output	>6800N.M
Drive square	1"
Weight	9kg
Material	40Cr
Sockets	1-4pcs

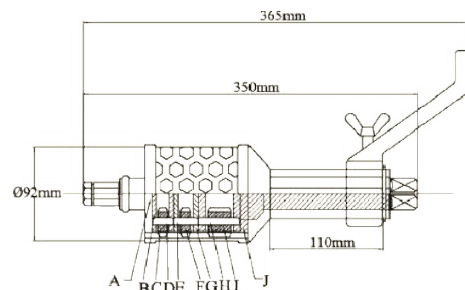

Code name	A	B	C	D	E	F	G	H	I	J
Name	Main input shaft	2-stage input	H17 Gear	Pin	Pin	H17 Gear	3-stage input	Pin	H25 Gear	Output shaft
Quantity	1	1	3	3	3	3	1	3	3	1
Gear modulus	2.5	2.5	2.5			2.5	2.5		2.5	

SOCKET (WX70)

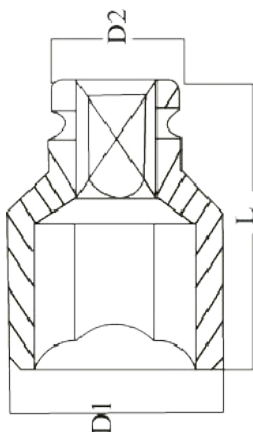

Model	D1 (mm)	D2 (mm)	L (mm)	Square
WX7053	φ53	φ50	80	25.4
WX7054	φ54	φ50	80	25.4
WX7055	φ55.5	φ51	80	25.4
WX7058	φ58	φ52	80	25.4
WX7061	φ61	φ52	80	25.4
WX7064	φ64.5	φ53	86	25.4
WX7065	φ64.5	φ54/64	86	25.4
WX7069	φ69	φ56/64	86	25.4/31.75
WX7074	φ74	φ56/66	90	25.4/31.75
WX7081	φ81	φ58	100	25.4/31.75
WX7084	φ84	φ58	80	25.4
WX7087	φ87	φ58/66	103	25.4/31.75
WX7093	φ93	φ59/67	103	25.4/31.75

Available socket size: 17-41mm





Part#	Thread Size
1002	7/16
1003	3/8
1004	1/2
1005	10mmx1.25
1006	12mmx1.25
1007	12mmx1.50
1009	14mmx1.50
1010	14mmx2.00

Part#	Thread Size
1002-L27	7/16
1003-L27	3/8
1004-L27	1/2
1005-L27	10mmx1.25
1006-L27	12mmx1.25
1007-L27	12mmx1.50
1009-L27	14mmx1.50
1010-L27	14mmx2.00

Part#	Thread Size
1002-L32	7/16
1003-L32	3/8
1004-L32	1/2
1005-L32	10mmx1.25
1006-L32	12mmx1.25
1007-L32	12mmx1.50
1009-L32	14mmx1.50
1010-L32	14mmx2.00

Part#	Thread Size
1002-L40	7/16
1003-L40	3/8
1004-L40	1/2
1005-L40	10mmx1.25
1006-L40	12mmx1.25
1007-L40	12mmx1.50
1009-L40	14mmx1.50
1010-L40	14mmx2.00

Part#	Thread Size
1002-L40	7/16
1003-L40	3/8
1004-L40	1/2
1005-L40	10mmx1.25
1006-L40	12mmx1.25
1007-L40	12mmx1.50
1009-L40	14mmx1.50
1010-L40	14mmx2.00



Part#	Thread Size
1002-L48	7/16
1003-L48	3/8
1004-L48	1/2
1005-L48	10mmx1.25
1006-L48	12mmx1.25
1007-L48	12mmx1.50
1009-L48	14mmx1.50
1010-L48	14mmx2.00

Part#	Thread Size
1002S	7/16
1003S	3/8
1004S	1/2
1005S	10mmx1.25
1006S	12mmx1.25
1007S	12mmx1.50
1009S	14mmx1.50
1010S	14mmx2.00

Part#	Thread Size
1002S-L27	7/16
1003S-L27	3/8
1004S-L27	1/2
1005S-L27	10mmx1.25
1006S-L27	12mmx1.25
1007S-L27	12mmx1.50
1009S-L27	14mmx1.50
1010S-L27	14mmx2.00

Part#	Thread Size
1002S-L37	7/16
1003S-L37	3/8
1004S-L37	1/2
1005S-L37	10mmx1.25
1006S-L37	12mmx1.25
1007S-L37	12mmx1.50
1009S-L37	14mmx1.50
1010S-L37	14mmx2.00

Part#	Thread Size
1002S-L42	7/16
1003S-L42	3/8
1004S-L42	1/2
1005S-L42	10mmx1.25
1006S-L42	12mmx1.25
1007S-L42	12mmx1.50
1009S-L42	14mmx1.50
1010S-L42	14mmx2.00



Part#	Thread Size
1002S-L45	7/16
1003S-L45	3/8
1004S-L45	1/2
1005S-L45	10mmx1.25
1006S-L45	12mmx1.25
1007S-L45	12mmx1.50
1009S-L45	14mmx1.50
1010S-L45	14mmx2.00

Part#	Thread Size
1002XS	7/16
1003XS	3/8
1004XS	1/2
1005XS	10mmx1.25
1006XS	12mmx1.25
1007XS	12mmx1.50
1009XS	14mmx1.50
1010XS	14mmx2.00

Part#	Thread Size
1202	7/16
1203	3/8
1204	1/2
1205	10mmx1.25
1206	12mmx1.25
1207	12mmx1.50
1209	14mmx1.50
1210	14mmx2.00

Part#	Thread Size
1202S	7/16
1203S	3/8
1204S	1/2
1205S	10mmx1.25
1206S	12mmx1.25
1207S	12mmx1.50
1209S	14mmx1.50
1210S	14mmx2.00

Part#	Thread Size
1002E	7/16
1004E	3/8
1005E	1/2
1006E	10mmx1.25
1007E	12mmx1.25
10012E	12mmx1.50
1009E	14mmx1.50
1050E	14mmx2.00



Part#	Thread Size
1002A	7/16
1003A	3/8
1004A	1/2
1005A	10mmx1.25
1006A	12mmx1.25
1007A	12mmx1.50
1009A	14mmx1.50
1010A	14mmx2.00

Part#	Thread Size
1002A-L29	7/16
1003A-L29	3/8
1004A-L29	1/2
1005A-L29	10mmx1.25
1006A-L29	12mmx1.25
1007A-L29	12mmx1.50
1009A-L29	14mmx1.50
1010A-L29	14mmx2.00

Part#	Thread Size
1002SA	7/16
1003SA	3/8
1004SA	1/2
1005SA	10mmx1.25
1006SA	12mmx1.25
1007SA	12mmx1.50
1009SA	14mmx1.50
1010SA	14mmx2.00

Part#	Thread Size
1002SA-L25	7/16
1003SA-L25	3/8
1004SA-L25	1/2
1005SA-L25	10mmx1.25
1006SA-L25	12mmx1.25
1007SA-L25	12mmx1.50
1009SA-L25	14mmx1.50
1010SA-L25	14mmx2.00

Part#	Thread Size
1002XSA-L23	7/16
1003XSA-L23	3/8
1004XSA-L23	1/2
1005XSA-L23	10mmx1.25
1006XSA-L23	12mmx1.25
1007XSA-L23	12mmx1.50
1009XSA-L23	14mmx1.50
1010XSA-L23	14mmx2.00



Part#	Thread Size
1002Z	7/16
1003Z	3/8
1004Z	1/2
1005Z	10mmx1.25
1006Z	12mmx1.25
1007Z	12mmx1.50
1009Z	14mmx1.50
1010Z	14mmx2.00

Part#	Thread Size
1002Z-L27	7/16
1003Z-L27	3/8
1004Z-L27	1/2
1005Z-L27	10mmx1.25
1006Z-L27	12mmx1.25
1007Z-L27	12mmx1.50
1009Z-L27	14mmx1.50
1010Z-L27	14mmx2.00

Part#	Thread Size
1002Z-L32	7/16
1003Z-L32	3/8
1004Z-L32	1/2
1005Z-L32	10mmx1.25
1006Z-L32	12mmx1.25
1007Z-L32	12mmx1.50
1009Z-L32	14mmx1.50
1010Z-L32	14mmx2.00

Part#	Thread Size
1002Z-L48	7/16
1003Z-L48	3/8
1004Z-L48	1/2
1005Z-L48	10mmx1.25
1006Z-L48	12mmx1.25
1007Z-L48	12mmx1.50
1009Z-L48	14mmx1.50
1010Z-L48	14mmx2.00

Part#	Thread Size
1002TZ	7/16
1003TZ	3/8
1004TZ	1/2
1005TZ	10mmx1.25
1006TZ	12mmx1.25
1007TZ	12mmx1.50
1009TZ	14mmx1.50
1010TZ	14mmx2.00





Part#	Thread Size
1702	7/16
1703	3/8
1704	1/2
1705	10mmx1.25
1706	12mmx1.25
1707	12mmx1.50
1709	14mmx1.50
1710	14mmx2.00

Part#	Thread Size
1702-L48	7/16
1703-L48	3/8
1704-L48	1/2
1705-L48	10mmx1.25
1706-L48	12mmx1.25
1707-L48	12mmx1.50
1709-L48	14mmx1.50
1710-L48	14mmx2.00

Part#	Thread Size
1702-LS	7/16
1703-LS	3/8
1704-LS	1/2
1705-LS	10mmx1.25
1706-LS	12mmx1.25
1707-LS	12mmx1.50
1709-LS	14mmx1.50
1710-LS	14mmx2.00

Part#	Thread Size
1702S-L54	7/16
1703S-L54	3/8
1704S-L54	1/2
1705S-L54	10mmx1.25
1706S-L54	12mmx1.25
1707S-L54	12mmx1.50
1709S-L54	14mmx1.50
1710S-L54	14mmx2.00

Part#	Thread Size
1702SR	7/16
1703SR	3/8
1704SR	1/2
1705SR	10mmx1.25
1706SR	12mmx1.25
1707SR	12mmx1.50
1709SR	14mmx1.50
1710SR	14mmx2.00



Part#	Thread Size
1702Z	7/16
1703Z	3/8
1704Z	1/2
1705Z	10mmx1.50
1706Z	12mmx1.50
1707Z	12mmx1.75
1709Z	14mmx1.50
1710Z	14mmx2.00

Part#	Thread Size
1902	7/16
1903	3/8
1904	1/2
1905	10mmx1.25
1906	12mmx1.25
1907	12mmx1.50
1909	14mmx1.50
1910	14mmx2.00

Part#	Thread Size
1902-L27	7/16
1903-L27	3/8
1904-L27	1/2
1905-L27	10mmx1.25
1906-L27	12mmx1.25
1907-L27	12mmx1.50
1909-L27	14mmx1.50
1910-L27	14mmx2.00

Part#	Thread Size
1902-L44	7/16
1903-L44	3/8
1904-L44	1/2
1905-L44	10mmx1.25
1906-L44	12mmx1.25
1907-L44	12mmx1.50
1909-L44	14mmx1.50
1910-L44	14mmx2.00

Part#	Thread Size
1902S	7/16
1903S	3/8
1904S	1/2
1905S	10mmx1.25
1906S	12mmx1.25
1907S	12mmx1.50
1909S	14mmx1.50
1910S	14mmx2.00



Part#	Thread Size
1902S-L27	7/16
1903S-L27	3/8
1904S-L27	1/2
1905S-L27	10mmx1.25
1906S-L27	12mmx1.25
1907S-L27	12mmx1.50
1909S-L27	14mmx1.50
1910S-L27	14mmx2.00

Part#	Thread Size
1902S-L44	7/16
1903S-L44	3/8
1904S-L44	1/2
1905S-L44	10mmx1.25
1906S-L44	12mmx1.25
1907S-L44	12mmx1.50
1909S-L44	14mmx1.50
1910S-L44	14mmx2.00

Part#	Thread Size
1902XS	7/16
1903XS	3/8
1904XS	1/2
1905XS	10mmx1.25
1906XS	12mmx1.25
1907XS	12mmx1.50
1909XS	14mmx1.50
1910XS	14mmx2.00

Part#	Thread Size
1902XS-L32	7/16
1903XS-L32	3/8
1904XS-L32	1/2
1905XS-L32	10mmx1.25
1906XS-L32	12mmx1.25
1907XS-L32	12mmx1.50
1909XS-L32	14mmx1.50
1910XS-L32	14mmx2.00

Part#	Thread Size
1902XS-L45	7/16
1903XS-L45	3/8
1904XS-L45	1/2
1905XS-L45	10mmx1.25
1906XS-L45	12mmx1.25
1907XS-L45	12mmx1.50
1909XS-L45	14mmx1.50
1910XS-L45	14mmx2.00



Part#	Thread Size
1902SR	7/16
1903SR	3/8
1904SR	1/2
1905SR	10mmx1.25
1906SR	12mmx1.25
1907SR	12mmx1.50
1909SR	14mmx1.50
1910SR	14mmx2.00

Part#	Thread Size
1902E	7/16
1903E	3/8
1904E	1/2
1905E	10mmx1.25
1906E	12mmx1.25
1907E	12mmx1.50
1909E	14mmx1.50
1910E	14mmx2.00

Part#	Thread Size
19020	7/16
19030	3/8
19040	1/2
19050	12mmx1.25
19060	12mmx1.25
19070	12mmx1.50
19090	14mmx1.50
19100	14mmx2.00

Part#	Thread Size
1902X	7/16
1903X	3/8
1904X	1/2
1905X	10mmx1.25
1906X	12mmx1.25
1907X	12mmx1.50
1909X	14mmx1.50
1910X	14mmx2.00

Part#	Thread Size
1502S	7/16
1503S	3/8
1504S	1/2
1505S	10mmx1.25
1506S	12mmx1.25
1507S	12mmx1.50
1509S	14mmx1.50
1510S	14mmx2.00



Part#	Thread Size
1902S-CW	7/16
1903S-CW	3/8
1904S-CW	1/2
1905S-CW	10mmx1.25
1906S-CW	12mmx1.25
1907S-CW	12mmx1.50
1909S-CW	14mmx1.50
1910S-CW	14mmx2.00

Part#	Thread Size
1902E-CW	7/16
1903E-CW	3/8
1904E-CW	1/2
1905E-CW	10mmx1.25
1906E-CW	12mmx1.25
1907E-CW	12mmx1.50
1909E-CW	14mmx1.50
1910E-CW	14mmx2.00

Part#	Thread Size
1902-PW	7/16
1903-PW	3/8
1904-PW	1/2
1905-PW	10mmx1.25
1906-PW	12mmx1.25
1907-PW	12mmx1.50
1909-PW	14mmx1.50
1910-PW	14mmx2.00

Part#	Thread Size
1902S-PW	7/16
1903S-PW	3/8
1904S-PW	1/2
1905S-PW	10mmx1.25
1906S-PW	12mmx1.25
1907S-PW	12mmx1.50
1909S-PW	14mmx1.50
1910S-PW	14mmx2.00

Part#	Thread Size
1902T-PW	7/16
1903T-PW	3/8
1904T-PW	1/2
1905T-PW	10mmx1.25
1906T-PW	12mmx1.25
1907T-PW	12mmx1.50
1909T-PW	14mmx1.50
1910T-PW	14mmx2.00





HEX 21



HEX 19

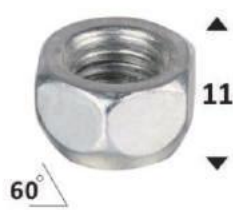

HEX 19



HEX 17



HEX 22

Part#	Thread Size
1302	7/16
1303	3/8
1304	1/2
1305	10mmx1.25
1306	12mmx1.25
1307	12mmx1.50
1309	14mmx1.50
1310	14mmx2.00

Part#	Thread Size
1302S	7/16
1303S	3/8
1304S	1/2
1305S	10mmx1.25
1306S	12mmx1.25
1307S	12mmx1.50
1309S	14mmx1.50
1310S	14mmx2.00

Part#	Thread Size
1302S-L11	7/16
1303S-L11	3/8
1304S-L11	1/2
1305S-L11	10mmx1.25
1306S-L11	12mmx1.25
1307S-L11	12mmx1.50
1309S-L11	14mmx1.50
1310S-L11	14mmx2.00

Part#	Thread Size
1302XS	7/16
1303XS	3/8
1304XS	1/2
1305XS	10mmx1.25
1306XS	12mmx1.25
1307XS	12mmx1.50
1309XS	14mmx1.50
1310XS	14mmx2.00

Part#	Thread Size
1302T-L18	7/16
1303T-L18	3/8
1304T-L18	1/2
1305T-L18	10mmx1.25
1306T-L18	12mmx1.25
1307T-L18	12mmx1.50
1309T-L18	14mmx1.50
1310T-L18	14mmx2.00



HEX 21



HEX 21



HEX 19



HEX 19



HEX 19

Part#	Thread Size
1302-1	7/16
1303-1	3/8
1304-1	1/2
1305-1	10mmx1.25
1306-1	12mmx1.25
1307-1	12mmx1.50
1309-1	14mmx1.50
1310-1	14mmx2.00

Part#	Thread Size
1302-1L25	7/16
1303-1L25	3/8
1304-1L25	1/2
1305-1L25	10mmx1.25
1306-1L25	12mmx1.25
1307-1L25	12mmx1.50
1309-1L25	14mmx1.50
1310-1L25	14mmx2.00

Part#	Thread Size
1302-1S	7/16
1303-1S	3/8
1304-1S	1/2
1305-1S	10mmx1.25
1306-1S	12mmx1.25
1307-1S	12mmx1.50
1309-1S	14mmx1.50
1310-1S	14mmx2.00

Part#	Thread Size
1302-1SL25	7/16
1303-1SL25	3/8
1304-1SL25	1/2
1305-1SL25	10mmx1.25
1306-1SL25	12mmx1.25
1307-1SL25	12mmx1.50
1309-1SL25	14mmx1.50
1310-1SL25	14mmx2.00

Part#	Thread Size
1302-1SL30	7/16
1303-1SL30	3/8
1304-1SL30	1/2
1305-1SL30	10mmx1.25
1306-1SL30	12mmx1.25
1307-1SL30	12mmx1.50
1309-1SL30	14mmx1.50
1310-1SL30	14mmx2.00



HEX 17



HEX 17



HEX 19



HEX 17



HEX 17

Part#	Thread Size
1302-1XS	7/16
1303-1XS	3/8
1304-1XS	1/2
1305-1XS	10mmx1.25
1306-1XS	12mmx1.25
1307-1XS	12mmx1.50
1309-1XS	14mmx1.50
1310-1XS	14mmx2.00

Part#	Thread Size
1302-1XSL25	7/16
1303-1XSL25	3/8
1304-1XSL25	1/2
1305-1XSL25	10mmx1.25
1306-1XSL25	12mmx1.25
1307-1XSL25	12mmx1.50
1309-1XSL25	14mmx1.50
1310-1XSL25	14mmx2.00

Part#	Thread Size
1302-1SR	7/16
1303-1SR	3/8
1304-1SR	1/2
1305-1SR	10mmx1.25
1306-1SR	12mmx1.25
1307-1SR	12mmx1.50
1309-1SR	14mmx1.50
1310-1SR	14mmx2.00

Part#	Thread Size
1302-1XSR	7/16
1303-1XSR	3/8
1304-1XSR	1/2
1305-1XSR	10mmx1.25
1306-1XSR	12mmx1.25
1307-1XSR	12mmx1.50
1309-1XSR	14mmx1.50
1310-1XSR	14mmx2.00

Part#	Thread Size
1302-2XS	7/16
1303-2XS	3/8
1304-2XS	1/2
1305-2XS	10mmx1.25
1306-2XS	12mmx1.25
1307-2XS	12mmx1.50
1309-2XS	14mmx1.50
1310-2XS	14mmx2.00



HEX 21

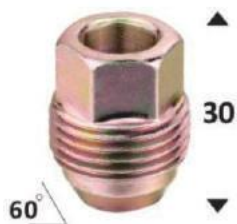

HEX 21



HEX 19



HEX 22

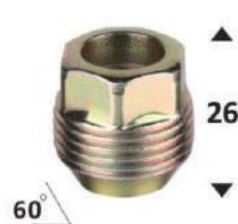

HEX 22

Part#	Thread Size
1302-2S	7/16
1303-2S	3/8
1304-2S	1/2
1305-2S	10mmx1.25
1306-2S	12mmx1.25
1307-2S	12mmx1.50
1309-2S	14mmx1.50
1310-2S	14mmx2.00

Part#	Thread Size
2002	7/16
2003	3/8
2004	1/2
2005	10mmx1.25
2006	12mmx1.25
2007	12mmx1.50
2009	14mmx1.50
2010	14mmx2.00

Part#	Thread Size
2002S	7/16
2003S	3/8
2004S	1/2
2005S	10mmx1.25
2006S	12mmx1.25
2007S	12mmx1.50
2009S	14mmx1.50
2010S	14mmx2.00

Part#	Thread Size
2002T	7/16
2003T	3/8
2004T	1/2
2005T	10mmx1.25
2006T	12mmx1.25
2007T	12mmx1.50
2009T	14mmx1.50
2010T	14mmx2.00

Part#	Thread Size
2002T-L26	7/16
2003T-L26	3/8
2004T-L26	1/2
2005T-L26	10mmx1.25
2006T-L26	12mmx1.25
2007T-L26	12mmx1.50
2009T-L26	14mmx1.50
2010T-L26	14mmx2.00





HEX 21

Part#	Thread Size
5002	7/16
5003	3/8
5004	1/2
5005	10mmx1.25
5006	12mmx1.25
5007	12mmx1.50
5009	14mmx1.50
5010	14mmx2.00



HEX 21

Part#	Thread Size
5002-L38	7/16
5003-L38	3/8
5004-L38	1/2
5005-L38	10mmx1.25
5006-L38	12mmx1.25
5007-L38	12mmx1.50
5009-L38	14mmx1.50
5010-L38	14mmx2.00



HEX 21

Part#	Thread Size
5002-L46	7/16
5003-L46	3/8
5004-L46	1/2
5005-L46	10mmx1.25
5006-L46	12mmx1.25
5007-L46	12mmx1.50
5009-L46	14mmx1.50
5010-L46	14mmx2.00



HEX 21

Part#	Thread Size
5002B	7/16
5003B	3/8
5004B	1/2
5005B	10mmx1.25
5006B	12mmx1.25
5007B	12mmx1.50
5009B	14mmx1.50
5010B	14mmx2.00



HEX 21

Part#	Thread Size
5002B-L38	7/16
5003B-L38	3/8
5004B-L38	1/2
5005B-L38	10mmx1.25
5006B-L38	12mmx1.25
5007B-L38	12mmx1.50
5009B-L38	14mmx1.50
5010B-L38	14mmx2.00



HEX 21

Part#	Thread Size
5002O	7/16
5003O	3/8
5004O	1/2
5005O	10mmx1.25
5006O	12mmx1.25
5007O	12mmx1.50
5009O	14mmx1.50
5010O	14mmx2.00



HEX 21

Part#	Thread Size
5102	7/16
5103	3/8
5104	1/2
5105	10mmx1.25
5106	12mmx1.25
5107	12mmx1.50
5109	14mmx1.50
5110	14mmx2.00



HEX 19

Part#	Thread Size
5202	7/16
5203	3/8
5204	1/2
5205	10mmx1.25
5206	12mmx1.25
5207	12mmx1.50
5209	14mmx1.50
5210	14mmx2.00



HEX 21

Part#	Thread Size
5102O	7/16
5103O	3/8
5104O	1/2
5105O	10mmx1.25
5106O	12mmx1.25
5107O	12mmx1.50
5109O	14mmx1.50
5110O	14mmx2.00



HEX 21

Part#	Thread Size
5102O-L20	7/16
5103O-L20	3/8
5104O-L20	1/2
5105O-L20	10mmx1.25
5106O-L20	12mmx1.25
5107O-L20	12mmx1.50
5109O-L20	14mmx1.50
5110O-L20	14mmx2.00



HEX 21

Part#	Thread Size
5302	7/16
5303	3/8
5304	1/2
5305	10mmx1.25
5306	12mmx1.25
5307	12mmx1.50
5309	14mmx1.50
5310	14mmx2.00



HEX 21

Part#	Thread Size
5302L	7/16
5303L	3/8
5304L	1/2
5305L	10mmx1.25
5306L	12mmx1.25
5307L	12mmx1.50
5309L	14mmx1.50
5310L	14mmx2.00



HEX 21

Part#	Thread Size
5302-L58	7/16
5303-L58	3/8
5304-L58	1/2
5305-L58	10mmx1.25
5306-L58	12mmx1.25
5307-L58	12mmx1.50
5309-L58	14mmx1.50
5310-L58	14mmx2.00



HEX 21

Part#	Thread Size
5302-L42	7/16
5303-L42	3/8
5304-L42	1/2
5305-L42	10mmx1.25
5306-L42	12mmx1.25
5307-L42	12mmx1.50
5309-L42	14mmx1.50
5310-L42	14mmx2.00



HEX 21

Part#	Thread Size
5302A	7/16
5303A	3/8
5304A	1/2
5305A	10mmx1.25
5306A	12mmx1.25
5307A	12mmx1.50
5309A	14mmx1.50
5310A	14mmx2.00



Part#	Thread Size
5302TL	7/16
5303TL	3/8
5304TL	1/2
5305TL	10mmx1.25
5306TL	12mmx1.25
5307TL	12mmx1.50
5309TL	14mmx1.50
5310TL	14mmx2.00

Part#	Thread Size
5302A-L47	7/16
5303A-L47	3/8
5304A-L47	1/2
5305A-L47	10mmx1.25
5306A-L47	12mmx1.25
5307A-L47	12mmx1.50
5309A-L47	14mmx1.50
5310A-L47	14mmx2.00

Part#	Thread Size
5302A-L51	7/16
5303A-L51	3/8
5304A-L51	1/2
5305A-L51	10mmx1.25
5306A-L51	12mmx1.25
5307A-L51	12mmx1.50
5309A-L51	14mmx1.50
5310A-L51	14mmx2.00

Part#	Thread Size
5502	7/16
5503	3/8
5504	1/2
5505	10mmx1.25
5506	12mmx1.25
5507	12mmx1.50
5509	14mmx1.50
5510	14mmx2.00

Part#	Thread Size
5502-L40	7/16
5503-L40	3/8
5504-L40	1/2
5505-L40	10mmx1.25
5506-L40	12mmx1.25
5507-L40	12mmx1.50
5509-L40	14mmx1.50
5510-L40	14mmx2.00



Part#	Thread Size
5502Z	7/16
5503Z	3/8
5504Z	1/2
5505Z	10mmx1.25
5506Z	12mmx1.25
5507Z	12mmx1.50
5509Z	14mmx1.50
5510Z	14mmx2.00

Part#	Thread Size
5402	7/16
5403	3/8
5404	1/2
5405	10mmx1.25
5406	12mmx1.25
5407	12mmx1.50
5409	14mmx1.50
5410	14mmx2.00

Part#	Thread Size
5602	7/16
5603	3/8
5604	1/2
5605	10mmx1.25
5606	12mmx1.25
5607	12mmx1.50
5609	14mmx1.50
5610	14mmx2.00

Part#	Thread Size
5702	7/16
5703	3/8
5704	1/2
5705	10mmx1.25
5706	12mmx1.25
5707	12mmx1.50
5709	14mmx1.50
5710	14mmx2.00



6 Point tuner



HEX 20



HEX 20



HEX 20



HEX 20

Part#	Thread Size
2802	7/16
2803	3/8
2804	1/2
2805	10mmx1.25
2806	12mmx1.25
2807	12mmx1.50
2809	14mmx1.50
2810	14mmx2.00

Part#	Thread Size
2802BK	7/16
2803BK	3/8
2804BK	1/2
2805BK	10mmx1.25
2806BK	12mmx1.25
2807BK	12mmx1.50
2809BK	14mmx1.50
2810BK	14mmx2.00

Part#	Thread Size
2802R	7/16
2803R	3/8
2804R	1/2
2805R	10mmx1.25
2806R	12mmx1.25
2807R	12mmx1.50
2809R	14mmx1.50
2810R	14mmx2.00

Part#	Thread Size
2802B	7/16
2803B	3/8
2804B	1/2
2805B	10mmx1.25
2806B	12mmx1.25
2807B	12mmx1.50
2809B	14mmx1.50
2810B	14mmx2.00

6 Point Key



Part#	2800
Hex Size	19/21mm
Length	62mm



HEX 20



HEX 20



HEX 20

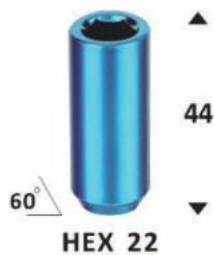

HEX 22

Part#	Thread Size
2802-L44	7/16
2803-L44	3/8
2804-L44	1/2
2805-L44	10mmx1.25
2806-L44	12mmx1.25
2807-L44	12mmx1.50
2809-L44	14mmx1.50
2810-L44	14mmx2.00

Part#	Thread Size
2802BK-L44	7/16
2803BK-L44	3/8
2804BK-L44	1/2
2805BK-L44	10mmx1.25
2806BK-L44	12mmx1.25
2807BK-L44	12mmx1.50
2809BK-L44	14mmx1.50
2810BK-L44	14mmx2.00

Part#	Thread Size
2802R-L44	7/16
2803R-L44	3/8
2804R-L44	1/2
2805R-L44	10mmx1.25
2806R-L44	12mmx1.25
2807R-L44	12mmx1.50
2809R-L44	14mmx1.50
2810R-L44	14mmx2.00

Part#	Thread Size
2802B-L44	7/16
2803B-L44	3/8
2804B-L44	1/2
2805B-L44	10mmx1.25
2806B-L44	12mmx1.25
2807B-L44	12mmx1.50
2809B-L44	14mmx1.50
2810B-L44	14mmx2.00

6 Point Key Longer



Part#	2800L
Thread Size	19/21mm
Length	70mm

9 Point Tuner



HEX 20



HEX 20



HEX 20



HEX 20

Part#	Thread Size
2802P-L44	7/16
2803P-L44	3/8
2804P-L44	1/2
2805P-L44	10mmx1.25
2806P-L44	12mmx1.25
2807P-L44	12mmx1.50
2809P-L44	14mmx1.50
2810P-L44	14mmx2.00

Part#	Thread Size
2802P	7/16
2803P	3/8
2804P	1/2
2805P	10mmx1.25
2806P	12mmx1.25
2807P	12mmx1.50
2809P	14mmx1.50
2810P	14mmx2.00

Part#	Thread Size
2902	7/16
2903	3/8
2904	1/2
2905	10mmx1.25
2906	12mmx1.25
2907	12mmx1.50
2909	14mmx1.50
2910	14mmx2.00

Part#	Thread Size
2902-L40	7/16
2903-L40	3/8
2904-L40	1/2
2905-L40	10mmx1.25
2906-L40	12mmx1.25
2907-L40	12mmx1.50
2909-L40	14mmx1.50
2910-L40	14mmx2.00

9 Point Key



Part#	2900
Hex Size	19/21mm
Length	62mm

6 Point Spline



6 Spline Wrench



Part# 3800
Hex Size 19/21mm

Part#	Thread Size
3802	7/16
3803	3/8
3804	1/2
3805	10mmx1.25
3806	12mmx1.25
3807	12mmx1.50
3809	14mmx1.50
3810	14mmx2.00

Part#	Thread Size
3802BK	7/16
3803BK	3/8
3804BK	1/2
3805BK	10mmx1.25
3806BK	12mmx1.25
3807BK	12mmx1.50
3809BK	14mmx1.50
3810BK	14mmx2.00

Part#	Thread Size
3802R	7/16
3803R	3/8
3804R	1/2
3805R	10mmx1.25
3806R	12mmx1.25
3807R	12mmx1.50
3809R	14mmx1.50
3810R	14mmx2.00

Part#	Thread Size
3802B	7/16
3803B	3/8
3804B	1/2
3805B	10mmx1.25
3806B	12mmx1.25
3807B	12mmx1.50
3809B	14mmx1.50
3810B	14mmx2.00



6 Spline Wrench Black



Part# 3800-B
Hex Size 19/21mm

Part#	Thread Size
3802N	7/16
3803N	3/8
3804N	1/2
3805N	10mmx1.25
3806N	12mmx1.25
3807N	12mmx1.50
3809N	14mmx1.50
3810N	14mmx2.00

Part#	Thread Size
3802o	7/16
3803o	3/8
3804o	1/2
3805o	10mmx1.25
3806o	12mmx1.25
3807o	12mmx1.50
3809o	14mmx1.50
3810o	14mmx2.00

Part#	Thread Size
3802o-R	7/16
3803o-R	3/8
3804o-R	1/2
3805o-R	10mmx1.25
3806o-R	12mmx1.25
3807o-R	12mmx1.50
3809o-R	14mmx1.50
3810o-R	14mmx2.00

Part#	Thread Size
3802X	7/16
3803X	3/8
3804X	1/2
3805X	10mmx1.25
3806X	12mmx1.25
3807X	12mmx1.50
3809X	14mmx1.50
3810X	14mmx2.00

7 Point Spline



7 Spline Wrench



Part# 3800D
Hex Size 21/22mm

7 Spline Wrench Black



Part# 3800DBK
Hex Size 21/22mm

Part#	Thread Size
3802D	7/16
3803D	3/8
3804D	1/2
3805D	10mmx1.25
3806D	12mmx1.25
3807D	12mmx1.50
3809D	14mmx1.50
3810D	14mmx2.00

Part#	Thread Size
3802D-L44	7/16
3803D-L44	3/8
3804D-L44	1/2
3805D-L44	10mmx1.25
3806D-L44	12mmx1.25
3807D-L44	12mmx1.50
3809D-L44	14mmx1.50
3810D-L44	14mmx2.00

Part#	Thread Size
3802BD-L51	7/16
3803BD-L51	3/8
3804BD-L51	1/2
3805BD-L51	10mmx1.25
3806BD-L51	12mmx1.25
3807BD-L51	12mmx1.50
3809BD-L51	14mmx1.50
3810BD-L51	14mmx2.00

Part#	Thread Size
3802oD	7/16
3803oD	3/8
3804oD	1/2
3805oD	10mmx1.25
3806oD	12mmx1.25
3807oD	12mmx1.50
3809oD	14mmx1.50
3810oD	14mmx2.00

5 Flower Lock



5 Flower Wrench



Part# 4800
HEX Size 19/21mm

Part#	Thread Size
40200S	7/16
40300S	3/8
40400S	1/2
40500S	10mmx1.25
40600S	12mmx1.25
40700S	12mmx1.50
40900S	14mmx1.50
41000S	14mmx2.00

Part#	Thread Size
40200SR	7/16
40300SR	3/8
40400SR	1/2
40500SR	10mmx1.25
40600SR	12mmx1.25
40700SR	12mmx1.50
40900SR	14mmx1.50
1010XSR	14mmx2.00

Part#	Thread Size
40200SB	7/16
40300SB	3/8
40400SB	1/2
40500SB	10mmx1.25
40600SB	12mmx1.25
40700SB	12mmx1.50
40900SB	14mmx1.50
41000XSB	14mmx2.00

Part#	Thread Size
40200S-L44	7/16
40300S-L44	3/8
40400S-L44	1/2
40500S-L44	10mmx1.25
40600S-L44	12mmx1.25
40700S-L44	12mmx1.50
40900S-L44	14mmx1.50
41000S-L44	14mmx2.00



Heptagon Wrench



Part# 3700L
Thread Size 19/21mm

Part#	Thread Size
40200S-L51	7/16
40300S-L51	3/8
40400S-L51	1/2
40500S-L51	10mmx1.25
40600S-L51	12mmx1.25
40700S-L51	12mmx1.50
40900S-L51	14mmx1.50
41000S-L51	14mmx2.00

Part#	Thread Size
40200S-PW	7/16
40300S-PW	3/8
40400S-PW	1/2
40500S-PW	10mmx1.25
40600S-PW	12mmx1.25
40700S-PW	12mmx1.50
40900S-PW	14mmx1.50
41000S-PW	14mmx2.00

Part#	Thread Size
40200SB-PW	7/16
40300SB-PW	3/8
40400SB-PW	1/2
40500SB-PW	10mmx1.25
40600SB-PW	12mmx1.25
40700SB-PW	12mmx1.50
40900SB-PW	14mmx1.50
41000SB-PW	14mmx2.00

Part#	Thread Size
40200SR-PW	7/16
40300SR-PW	3/8
40400SR-PW	1/2
40500SR-PW	10mmx1.25
40600SR-PW	12mmx1.25
40700SR-PW	12mmx1.50
40900SR-PW	14mmx1.50
41000SR-PW	14mmx2.00

Heptagon

Heptagon



Part#	Thread Size
3702	7/16
3703	3/8
3704	1/2
3705	10mmx1.25
3706	12mmx1.25
3707	12mmx1.50
3709	14mmx1.50
3710	14mmx2.00

Part#	Thread Size
3702N	7/16
3703N	3/8
3704N	1/2
3705N	10mmx1.25
3706N	12mmx1.25
3707N	12mmx1.50
3709N	14mmx1.50
3710N	14mmx2.00

Part#	Thread Size
3702B	7/16
3703B	3/8
3704B	1/2
3705B	10mmx1.25
3706B	12mmx1.25
3707B	12mmx1.50
3709B	14mmx1.50
3710B	14mmx2.00

Part#	Thread Size
3702R	7/16
3703R	3/8
3704R	1/2
3705R	10mmx1.25
3706R	12mmx1.25
3707R	12mmx1.50
3709R	14mmx1.50
3710R	14mmx2.00

7 Jugged



HEX 19

Part#	Thread Size
3902	7/16
3903	3/8
3904	1/2
3905	10mmx1.25
3906	12mmx1.25
3907	12mmx1.50
3909	14mmx1.50
3910	14mmx2.00

7 Jugged Wrench



Part#	Thread Size
3900	19/21mm

Racing Lock Nut



Part#	Thread Size
50200	7/16
50300	3/8
50400	1/2
50500	10mmx1.25
50600	12mmx1.25
50700	12mmx1.50
50900	14mmx1.50
51000	14mmx2.00



Part#	Thread Size
51200	7/16
51300	3/8
51400	1/2
51500	10mmx1.25
51600	12mmx1.25
51700	12mmx1.50
51900	14mmx1.50
52000	14mmx2.00

Key for racing Lock Nut



Part# 3900
Hex Size 19/21mm

Inner Flower



HEX 23

Part#	Thread Size
40200	7/16
40300	3/8
40400	1/2
40500	10mmx1.25
40600	12mmx1.25
40700	12mmx1.50
40900	14mmx1.50
41000	14mmx2.00



HEX 23

Part#	Thread Size
42200	7/16
42300	3/8
42400	1/2
42500	10mmx1.25
42600	12mmx1.25
42700	12mmx1.50
42900	14mmx1.50
43000	14mmx2.00



HEX 23

Part#	Thread Size
44200	7/16
44300	3/8
44400	1/2
44500	10mmx1.25
44600	12mmx1.25
44700	12mmx1.50
44900	14mmx1.50
45000	14mmx2.00



HEX 23

Part#	Thread Size
44200-L48	7/16
44300-L48	3/8
44400-L48	1/2
44500-L48	10mmx1.25
44600-L48	12mmx1.25
44700-L48	12mmx1.50
44900-L48	14mmx1.50
45000-L48	14mmx2.00

Flower Key



Part# 4800
Hex Size —

Washer Lock



HEX 19

Part#	Thread Size
3702E	7/16
3703E	3/8
3704E	1/2
3705E	10mmx1.25
3706E	12mmx1.25
3707E	12mmx1.50
3709E	14mmx1.50
3710E	14mmx2.00



HEX 20

Part#	Thread Size
45200	7/16
45300	3/8
45400	1/2
45500	10mmx1.25
45600	12mmx1.25
45700	12mmx1.50
45900	14mmx1.50
46000	14mmx2.00

Spinning Lock



Part#	Thread Size
46200	7/16
46300	3/8
46400	1/2
46500	10mmx1.25
46600	12mmx1.25
46700	12mmx1.50
46900	14mmx1.50
47000	14mmx2.00

Spinning Flower Wrench



Part# 6800
Hex Size —

Washer Flower Wrench



Part# 6800
Hex Size —

LUG BOLT

Hexagon Lug	Part#	Hex	ThreadLength	OverallLength	Thread Size	Seat
	172406	17	24	24	12x1.25	60*
	172407	17	24	24	12x1.50	60*
	172409	17	24	24	14x1.50	60*
	172806	17	28	28	12x1.25	60*
	172807	17	28	28	12x1.50	60*
	172809	17	28	28	14x1.50	60*
	173306	17	33	33	12x1.25	60*
	173307	17	33	33	12x1.50	60*
	173309	17	33	33	14x1.50	60*
	173906	17	39	39	12x1.25	60*
	173907	17	39	39	12x1.50	60*
	173909	17	39	39	14x1.50	60*

Hexagon Lug	Part#	Hex	ThreadLength	OverallLength	Thread Size	Seat
	172406R	17	24	51	12x1.25	R
	172407R	17	24	51	12x1.50	R
	172409R	17	24	51	14x1.50	R
	172806R	17	28	55	12x1.25	R
	172807R	17	28	55	12x1.50	R
	172809R	17	28	55	14x1.50	R
	173306R	17	33	60	12x1.25	R
	173307R	17	33	60	12x1.50	R
	173309R	17	33	60	14x1.50	R
	173906R	17	39	66	12x1.25	R
	173907R	17	39	66	12x1.50	R
	173909R	17	39	66	14x1.50	R

Hexagon Lug	Part#	Hex	ThreadLength	OverallLength	Thread Size	Seat
	192406	19	24	24	12x1.25	60*
	192407	19	24	24	12x1.50	60*
	192409	19	24	24	14x1.50	60*
	192806	19	28	28	12x1.25	60*
	192807	19	28	28	12x1.50	60*
	192809	19	28	28	14x1.50	60*
	193306	19	33	33	12x1.25	60*
	193307	19	33	33	12x1.50	60*
	193309	19	33	33	14x1.50	60*
	193906	19	39	39	12x1.25	60*
	193907	19	39	39	12x1.50	60*
	193909	19	39	39	14x1.50	60*

Hexagon Lug	Part#	Hex	ThreadLength	OverallLength	Thread Size	Seat
	192406R	19	24	24	12x1.25	R
	192407R	19	24	24	12x1.50	R
	192409R	19	24	24	14x1.50	R
	192806R	19	28	28	12x1.25	R
	192807R	19	28	28	12x1.50	R
	192809R	19	28	28	14x1.50	R
	193306R	19	33	33	12x1.25	R
	193307R	19	33	33	12x1.50	R
	193309R	19	33	33	14x1.50	R
	193906R	19	39	39	12x1.25	R
	193907R	19	39	39	12x1.50	R
	193909R	19	39	39	14x1.50	R

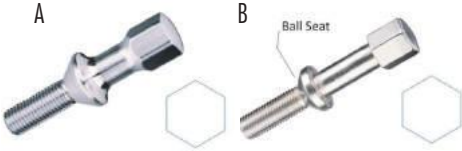
Hexagon Lug with Blank	Part#	Hex	ThreadLength	OverallLength	Thread Size	Seat
	9172406	17	24	57	12x1.25	60*
	9172407	17	24	57	12x1.50	60*
	9172409	17	24	57	14x1.50	60*
	9172406	17	24	60	12x1.25	R
	9172407	17	24	60	12x1.50	R
	9172409	17	24	60	14x1.50	R

Hexagon Lug with Washer	Part#	Hex	ThreadLength	OverallLength	Thread Size
	8172406	17	24	78	12x1.25
	8172407	17	24	78	12x1.50
	8172409	17	24	78	14x1.50
	8172806	17	28	78	12x1.25
	8172807	17	28	78	12x1.50
	8172809	17	28	78	14x1.50
	8173306	17	30	78	12x1.25
	8173307	17	30	78	12x1.50
	8173309	17	30	78	14x1.50

Hexagon Lug with Washer	Part#	Hex	ThreadLength	OverallLength	Thread Size
	8192406R	19	24	78	12x1.25
	8192407R	19	24	78	12x1.50
	8192409R	19	24	78	14x1.50
	8192806R	19	28	78	12x1.25
	8192807R	19	28	78	12x1.50
	8192809R	19	28	78	14x1.50
	8193306R	19	30	78	12x1.25
	8193307R	19	30	78	12x1.50
	8193309R	17	30	78	14x1.50

5 Flower Lock	Part#	Hex	ThreadLength	OverallLength	Thread Size	Seat
	52406	22	24	51	12x1.25	60*
	52407	22	24	51	12x1.50	60*
	52409	22	24	51	14x1.50	60*
	52806	22	28	55	12x1.25	60*
	52807	22	28	55	12x1.50	60*
	52809	22	28	55	14x1.50	60*
	53306	22	33	60	12x1.25	60*
	53307	22	33	60	12x1.50	60*
	53309	22	33	60	14x1.50	60*
	53906	22	39	66	12x1.25	60*
	53907	22	39	66	12x1.50	60*
53909	22	39	66	14x1.50	60*	

5 Flower Lock	Part#	Hex	ThreadLength	OverallLength	Thread Size	Seat
	52406R	22	24	51	12x1.25	R
	52407R	22	24	51	12x1.50	R
	52409R	22	24	51	14x1.50	R
	52806R	22	28	55	12x1.25	R
	52807R	22	28	55	12x1.50	R
	52809R	22	28	55	14x1.50	R
	53306R	22	33	60	12x1.25	R
	53307R	22	33	60	12x1.50	R
	53309R	22	33	60	14x1.50	R
	53906R	22	39	66	12x1.25	R
	53907R	22	39	66	12x1.50	R
53909R	22	39	66	14x1.50	R	

6 Flower Lock	Part#	Hex	ThreadLength	OverallLength	Thread Size	Seat
	62406	22	24	51	12x1.25	60*
	62407	22	24	51	12x1.50	60*
	62409	22	24	51	14x1.50	60*
	62806	22	28	55	12x1.25	60*
	62807	22	28	55	12x1.50	60*
	62809	22	28	55	14x1.50	60*
	63306	22	33	60	12x1.25	60*
	63307	22	33	60	12x1.50	60*
	63309	22	33	60	14x1.50	60*
	63906	22	39	66	12x1.25	60*
	63907	22	39	66	12x1.50	60*
63909	22	39	66	14x1.50	60*	

6 Point Spline	Part#	Hex	ThreadLength	OverallLength	Thread Size	Seat
	62406SP	20	24	51	12x1.25	60*
	62407SP	20	24	51	12x1.50	60*
	62409SP	20	24	51	14x1.50	60*
	62806SP	20	28	55	12x1.25	60*
	62807SP	20	28	55	12x1.50	60*
	62809SP	20	28	55	14x1.50	60*
	63306SP	20	33	60	12x1.25	60*
	63307SP	20	33	60	12x1.50	60*
	63309SP	20	33	60	14x1.50	60*
	63906SP	20	39	66	12x1.25	60*
	63907SP	20	39	66	12x1.50	60*
63909SP	20	39	66	14x1.50	60*	

7 Flower Lock	Part#	Hex	ThreadLength	OverallLength	Thread Size	Seat
	72406	22	24	51	12x1.25	60*
	72407	22	24	51	12x1.50	60*
	72409	22	24	51	14x1.50	60*
	72806	22	28	55	12x1.25	60*
	72807	22	28	55	12x1.50	60*
	72809	22	28	55	14x1.50	60*
	73306	22	33	60	12x1.25	60*
	73307	22	33	60	12x1.50	60*
	73309	22	33	60	14x1.50	60*
	73907	22	39	66	12x1.25	60*
	73907	22	39	66	12x1.50	60*
	73909	22	39	66	14x1.50	60*

6 Point Tuner	Part#	Hex	ThreadLength	OverallLength	Thread Size
	62406T	20	24	51	12x1.25
	62407T	20	24	51	12x1.50
	62409T	20	24	51	14x1.50
	62806T	20	28	55	12x1.25
	62807T	20	28	55	12x1.50
	62809T	20	28	55	14x1.50
	63306T	20	33	60	12x1.25
	63307T	20	33	60	12x1.50
	63309T	20	33	60	14x1.50
	63906T	20	39	66	12x1.25
	63907T	20	39	66	12x1.50
	63909T	20	39	66	14x1.50

Inner Flower	Part#	Hex	ThreadLength	OverallLength	Thread Size
	72406T	20	24	51	12x1.25
	72407T	20	24	51	12x1.50
	72409T	20	24	51	14x1.50
	72806T	20	28	55	12x1.25
	72807T	20	28	55	12x1.50
	72809T	20	28	55	14x1.50
	73306T	20	33	60	12x1.25
	73307T	20	33	60	12x1.50
	73309T	20	33	60	14x1.50
	73906T	20	39	66	12x1.25
	73907T	20	39	66	12x1.50
	73909T	20	39	66	14x1.50

9 Point Tuner	Part#	Hex	ThreadLength	OverallLength	Thread Size
	92406T	20	24	51	12x1.25
	92407T	20	24	51	12x1.50
	92409T	20	24	51	14x1.50
	92806T	20	28	55	12x1.25
	92807T	20	28	55	12x1.50
	92809T	20	28	55	14x1.50
	93306T	20	33	60	12x1.25
	93307T	20	33	60	12x1.50
	93309T	20	33	60	14x1.50
	93906T	20	39	66	12x1.25
	93907T	20	39	66	12x1.50
	93909T	20	39	66	14x1.50

Snap-in Tubeless Rubber Valves



TR412

TR413

TR414

TR414L

TR418

TR423

TR425

TR415

Chrome Sleeve Snap-in Tubeless Valves



TR412C

TR413C

TR414C

TR418C

TR418AC

TR414AC

TR413AC

TR412AC

Colorful Sleeve Snap-in Valves



TR413AC-Y

TR413AC-P

TR413AC-R

TR413AC-B

TR414AC-Y

TR414AC-P

TR414AC-R

TR414AC-B

Snap-in Tubeless For High Pressure Application



TR600HP

TR600HP-C

TR600HP-G

TR600HP-P

TR600HP-R

TR602HP

Tubeless Metal Clamp-in Valves



TR33E

TR43E

TR48E

TR48E-R

TR48E-B

EV42N2

Tubeless Metal Clamp-in Valves



TPMS Valve Core

TPMS-1

TPMS-2

TPMS-3

TR416

TR416S

Tubeless Valve for Motorcycles and Scooters

Tubeless Metal Clamp-in Valves For Truck and Bus

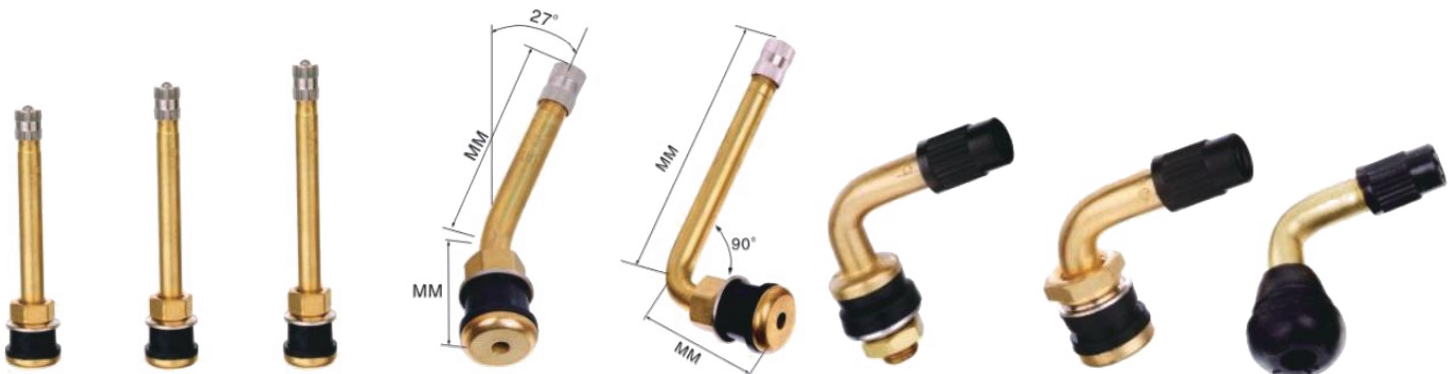

TR570

TR571

TR572

TR571-27°

TR571C

PVR30

PVR32

PVR70

Different color for your choosing



Different Package



Hub Ring



PLASTIC HUB RING

ALUMINIUM HUB RING

VEHICLE HUB OUTSIDE DIAMETER

O.D I.D	66.0-66.9	67.0-67.9	69.0-69.9	70.0-70.9	71.0-71.9	72.0-72.9	73.0-73.9	74.0-74.9	76.0-76.9	78.0-78.9	80.0-80.9
54.1	✓	✓	✓	✓	✓	✓	✓	✓	✓	✓	✓
56.2	✓	✓	✓	✓	✓	✓	✓	✓	✓	✓	✓
57.1	✓	✓	✓	✓	✓	✓	✓	✓	✓	✓	✓
59.2	✓	✓	✓	✓	✓	✓	✓	✓	✓	✓	✓
59.6	✓	✓	✓	✓	✓	✓	✓	✓	✓	✓	✓
60.1	✓	✓	✓	✓	✓	✓	✓	✓	✓	✓	✓
63.4	✓	✓	✓	✓	✓	✓	✓	✓	✓	✓	✓
63.4	✓	✓	✓	✓	✓	✓	✓	✓	✓	✓	✓
69.9	✓	✓	✓	✓	✓	✓	✓	✓	✓	✓	✓
64.1	✓	✓	✓	✓	✓	✓	✓	✓	✓	✓	✓
64.2	✓	✓	✓	✓	✓	✓	✓	✓	✓	✓	✓
65.1		✓	✓	✓	✓	✓	✓	✓	✓	✓	✓
65.2		✓	✓	✓	✓	✓	✓	✓	✓	✓	✓
66.1		✓	✓	✓	✓	✓	✓	✓	✓	✓	✓
66.6			✓	✓	✓	✓	✓	✓	✓	✓	✓
67.1			✓	✓	✓	✓	✓	✓	✓	✓	✓
676.1				✓	✓	✓	✓	✓	✓	✓	✓
67.2			✓	✓	✓	✓	✓	✓	✓	✓	✓
70.1					✓	✓	✓	✓	✓	✓	✓
70.3						✓	✓	✓	✓	✓	✓
70.5						✓	✓	✓	✓	✓	✓
71.5							✓	✓	✓	✓	✓
72.6								✓	✓	✓	✓
77.8									✓	✓	✓
78											✓
78.1											✓

WHEEL SPACER



Part#: WS-100
Description: 4&5 Holes on 98-120mm
Thickness:3mm,5mm,8mm
I.D: 78mm
O.D: 151mm

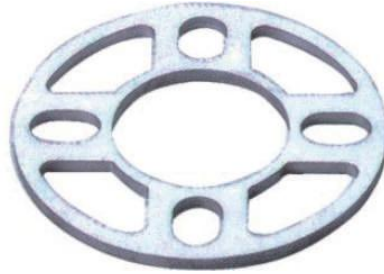

Part#: WS-101
Description: 4 Holes on 98-120mm
Thickness:8mm
I.D: 75.5mm
O.D: 151.51mm



Part#: WS-102
Description: 5 Holes on 108-120mm
Thickness:8mm
I.D: 90mm
O.D: 164.3mm



Part#: WS-103
Description: 4&5 Holes on 5-1/2mm
Thickness:5.8mm
I.D: 107mm
O.D: 178mm



Part#: WS-104
Description: 8 Holes on 165.1mm
Thickness:6mm
I.D: 125mm
O.D: 207.8mm



Part#: WS-105
Description:5 Holes on 100-120mm
Thickness:8mm
I.D: 81mm
O.D: 152mm



Part#: WS-106
Description: 5 Holes on 100-120mm
Thickness:5mm
I.D: 81mm
O.D: 152mm











Part#: WS-109
Description: 4&5 Holes on 98-120mm
Thickness:3mm,5mm,8mm
I.D: 78.5mm
O.D: 145mm





Part#: WS-110
Description: 5 Holes on 108-120mm
Thickness:3mm,5mm,8mm
I.D: 82mm
O.D: 151.5mm

ADHESIVE WHEEL BALANCE WEIGHT

Part#	Style	Material	Specification	Surface	Picture
WA01-F	Adhesive	Fe	5g*12	Zn/Epoxy Polyester Coating	
WA01-Z	Adhesive	Zn	5g*12	Zn/Epoxy Polyester Coating	
WA02-F	Adhesive	Fe	(5+10)g*4	Zn/Epoxy Polyester Coating	
WA02-Z	Adhesive	Zn	(5+10)g*4	Zn/Epoxy Polyester Coating	
WA02-P	Adhesive	Pb	(5+10)g*4	Zn/Epoxy Polyester Coating	
WA03-F	Adhesive	Fe	6g*10	Zn/Epoxy Polyester Coating	
WA04-F	Adhesive	Fe	1/40Z*12	Zn/Epoxy Polyester Coating	
WA04-P	Adhesive	Pb	1/40Z*12	Zn/Epoxy Polyester Coating	

CLIP-ON WHEEL BALANCE WEIGHT

Part#	Style	Material	Specification	Surface	Picture
WC01-F/Z/P	Adhesive	Fe ,Pb,Zn	5g,10g 15g,20g 25g,30g 35g,40g 45g,50g 55g,60g	Balancing weights used for steel wheel	
WC02-F/Z/P	Adhesive	Fe ,Pb,Zn	5g,10g 15g,20g 25g,30g 35g,40g 45g,50g 55g,60g	Balancing weights used for aluminium alloy wheel	





Part# RT004

1pc*T-handle front eye open plugger
1pc*T-handle screwdriver probe
1pc*Glue
5pc*String dia



Part# RT004

1pc*T-handle front eye open plugger
1pc*T-handle screwdriver probe
1pc*Glue
5pc*String dia



Part# RT004

1pc*T-handle front eye open plugger
1pc*T-handle screwdriver probe
1pc*Glue
5pc*String dia



XH6000 Thread Gauge Checker



XH6001 PCD Gauge



XH6002 Tire Patches

32mm Round Radial or Bias-Ply Tire Patches
38mm Round Radial or Bias-Ply Tire Patches
55mm Round Radial or Bias-Ply Tire Patches



Part# RT003



Part# RT004

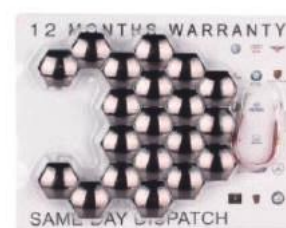

XH6003 Fastener Cap



Part# RT005



Part# RT006



HANGZHOU ATLI AUTO ACCESSORIES CO.,LTD.
杭州腾力汽配有限公司
ATLI INDUSTRY CO.,LIMITED
杭州腾力工贸有限公司

NO.1-1207 Tongren Jinhua Bld
NO.616,Gudun Rd, HangZhou,310015,ZheJing,China
浙江省杭州市古墩路616号同人精华大厦1号楼1207室
www.atlifix.com sales@atlifix.com
TEL:+86571 85839981 FAX:+86571 85839982