



—黄山华塑—
HUANSHAN HUASU

Decking Installation Guide



HOHecotech WPC



IMPORTANT: Read all sections before you start

Prior to installing any composite decking, it is recommended that you check with local building codes for any special requirements or restrictions. The diagrams and instructions outlined in this guide are for illustration purposes only and are not meant or implied to replace a licensed professional. Any construction or use of Hohecotech wpc must be in accordance with all local zoning and/or building codes. The consumer assumes all risks and liability associated with the construction and use of this product.

Essentials before installation

- 1 We suggest that the wpc decking should be installed by professional staff. WPC decking shall not be used as the component of the foundation or substructure. The ground or supporting structure should be strong enough to avoid from shifting, collapse and subsidence.
- 2 WPC decking CANNOT be paved directly on the surface like cement, brick, waterproof layer. It must installed onto a substructure.
- 3 Areas like heavy impact, long-term exposure to water or corrosive chemical erosion should be away from wpc boards.
- 4 Standard woodworking tools and fastener are required for installation. Fastener must be provided by Hohecotech.
- 5 Ventilation
Notes: Decking should not be installed in a closed area, and the ventilation conditions under the boards shall ensure air or water can flow through in case of quality issues.

! **Important:** Hohecotech products CANNOT be directly installed onto the ground. It must be installed onto a substructure that is made into a frame or joist, so there is adequate and unobstructed air flow under the decking to prevent excessive water absorption. If there is excessive water absorption to wpc, there could be some swelling that occurs. A minimum of 100 mm (4 inches) of continuous net free area under the decking surface is required for adequate ventilation on all decking, so air can circulate between adjacent members to promote drainage and drying. In the case that installation is below 100 mm (4 inches), it is recommended to look up the maximum rainfall of the area to determine what height would need to build to ensure no flooding of the deck occurs. If the rainfall is determined not to flood the deck, a slope of 10mm/meter must be used on the frame towards the direction of the drainage to ensure that there is no free-standing water. This way will make sure all wpc decking is not immersing into water in long time. So does the wpc tiles for its application area.

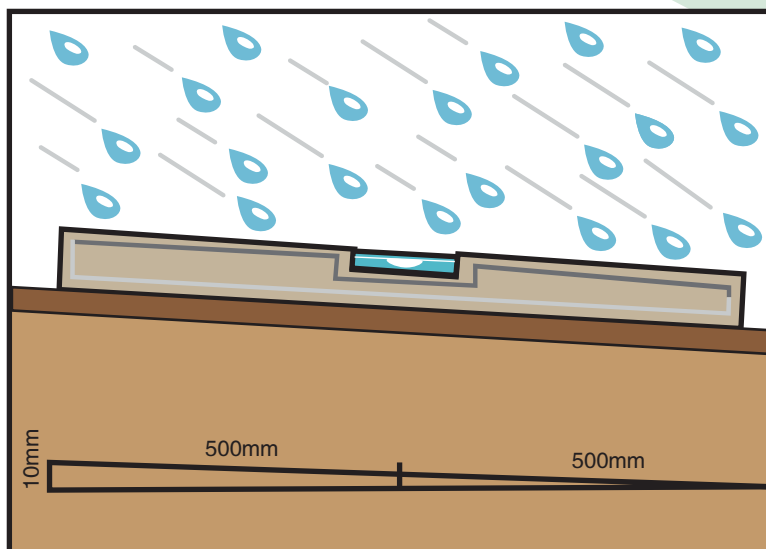

Storage

Hohecotech wpc shall be stored on a flat solid surface on joists or pallets, which is the correct way for storage.

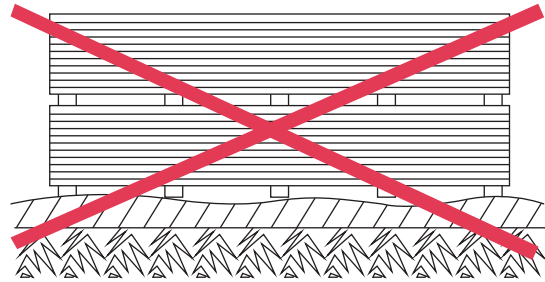
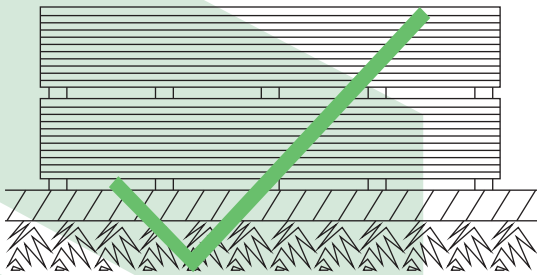

Step one: fixing joist

Joist must be fixed onto flat and hard ground. It is recommended to use treated Pine wood joist or wpc joist. Adequate spacing in the joists is required to keep the deck boards from bending. For residential project, the joists span on Center-to-Center should be less than 35cm; for commercial project, the joist span on Center-to-Center should be less than 30cm. If joist spanning on center-to-center with angled decking, the span should be 10cm less than normal requirement.

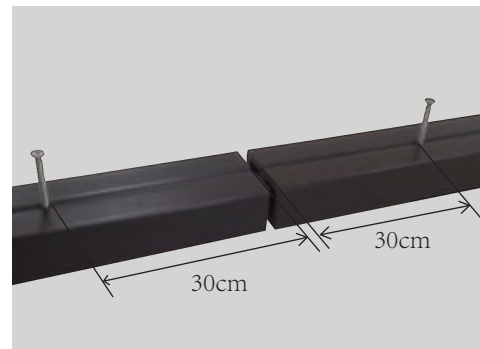
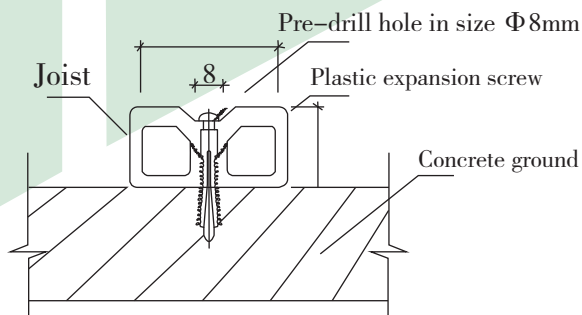

Joists span

	angled with 90	angled with 45
commercial usage	30cm	20cm
residential usage	35cm	25cm

commercial decking installation

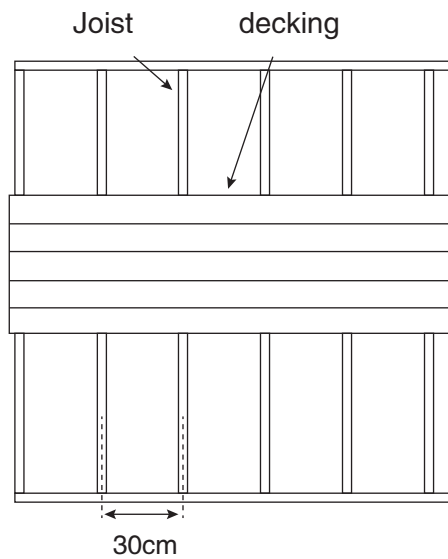

Figure a

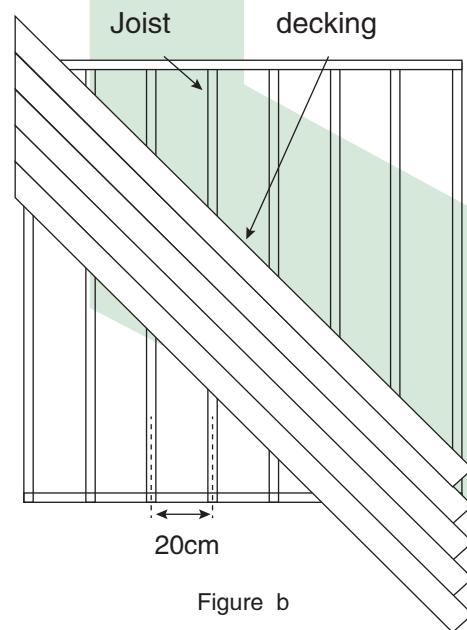

Figure b

Step 2: installing wpc decking

Make sure to always pre-drill the wpc profiles before fastening wpc decking. Make sure to leave enough gaps because wpc decking boards will experience expand and contract with changes in temperature. Expansion and contraction are most significant where extreme temperature changes occur. Fastening the deck planks according to the gapping requirements noted in the following key point.

Key point

- Side-to-side gap between boards: 3-7mm
- End-to-object and side to object gap: Min 5mm
- End-to-end gap: 3-7mm. Decking installed in winter should leave more gap than installed in summer due to the expansion and contraction.

Side - to - side
3 - 7mm

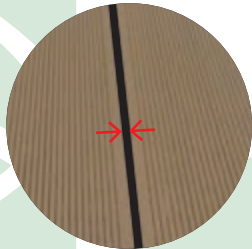

End - to - end:
3-7mm

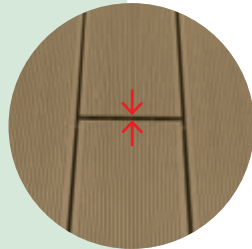

End - to - solid object:
> min 5mm



Side - to - solid object:
5mm minimum



The first board should be locked by starting fastener. When installing boards with one full length across the deck, we recommend use the none-walking clips to lock the board in the middle to make sure the board will not move and to allow for expansion and contraction to take place on both ends.

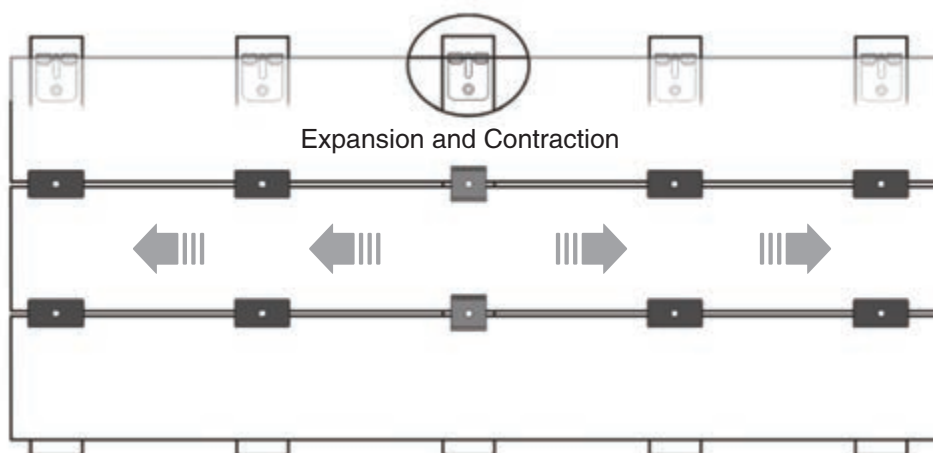

When installing two boards across the deck, none-walking clips are recommended to be used at the butt joints to ensure proper gapping during expansion and contraction as shown in Diagram. When butt jointing boards, sister joisting must be used so that each individual board sits on its own joist to ensure that the board will not slide off the joist. Also, there needs to be a minimum of 5 mm (0.2 inch) gap between the sister joists for water to go down between the joists or swelling could occur.



Usage for fastener

Pre-drill the joist and fix starting clips on joist, push the wpc board into starting clips as shown in below diagram.

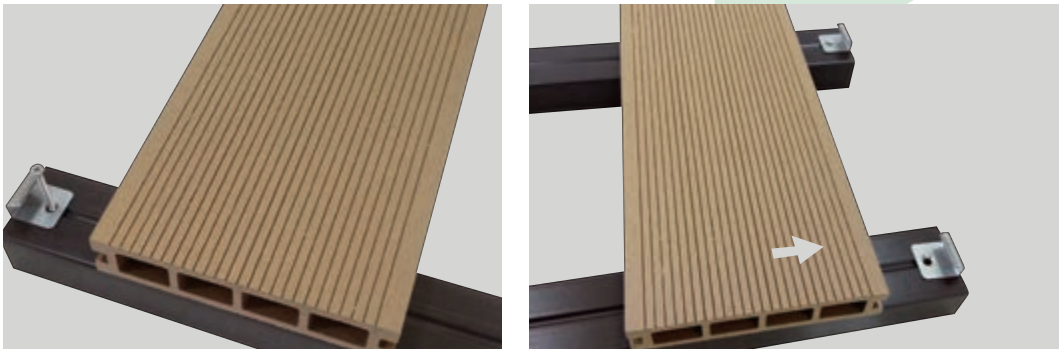

SY Series

Usage of SY series plastic fasteners: Slide in the SY series fastener into side groove of the board, or push another board after fixing the T series fastener into the groove.

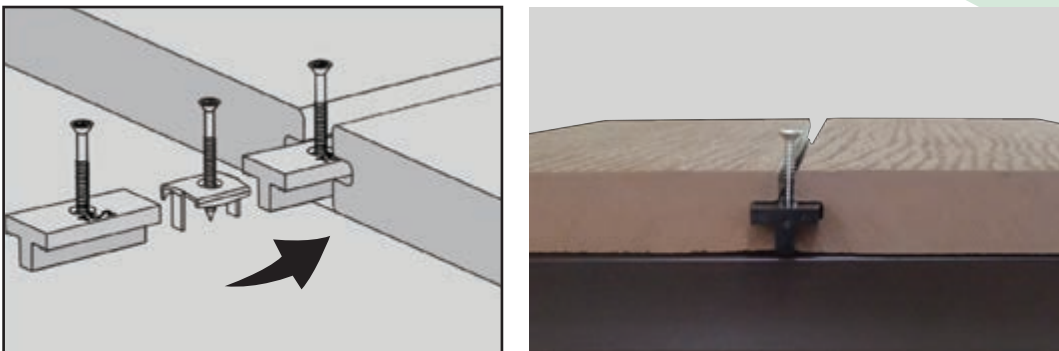

Usage of ST series stainless steel fasteners as below picture shows: put the ST clips into side groove of the board and fix it with screws(pre-drill required),and then push another board in.

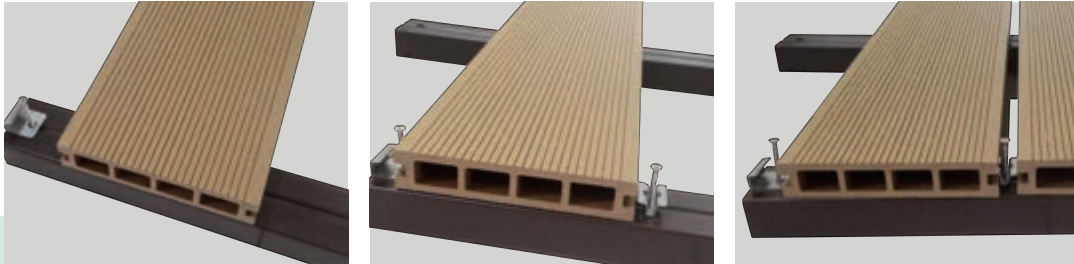

Usage of GG series stainless steel clips: put the GG clips into side groove of the board and fix it with screws, and then push another board in.

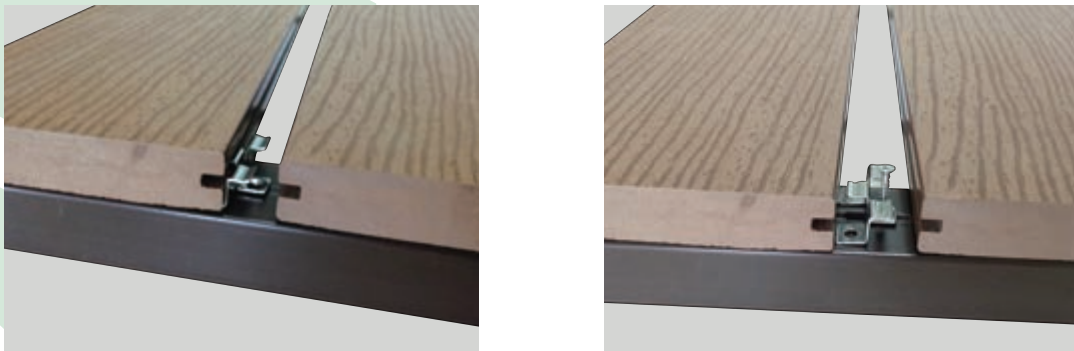

Step 3: Installation of fascia board

Facia board or corner trim must be pre-drilled before being screwed, and fascia board is mostly recommended. Facia board should leave min 2mm gap between wpc decking. The screws should drill into joist not decking board with facia board. Water proof silicone can be used in the end cap in case of peeling off, and then push into the decking board.

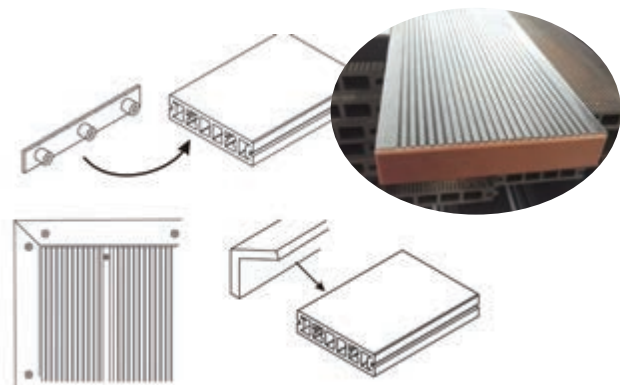
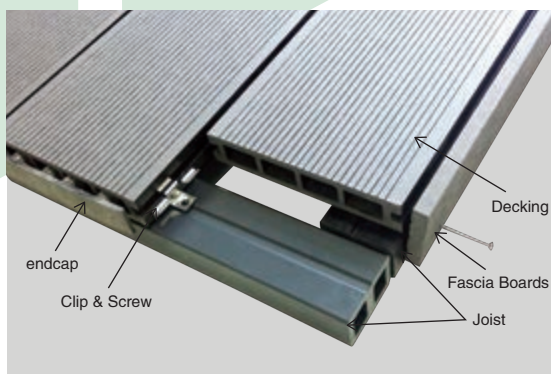

Care & Maintenance

Keep WPC products away from high-temperature equipment (such as heater, grilling apparatus, etc.) to avert deformation, discoloration, or other damages. Never let kerosene, gasoline, or other organic solvents come into contact with your deck.

Do not leave opened cans or other metal items on it unattended for a long time to prevent rust stains. Do not place heavy loads directly onto it and try to keep this material away from heavy impact or attack during usage to avoid any damages.

Please take care of it during transportation, installation and storage, avoid its falling from high place. Although WPC decking needs low-maintenance, periodic cleaning can help maintain its beauty. Power washing with proper cleaning agents may enhance the results. Spray in the direction of grain pattern to avoid damaging it. Use with caution not to damage the material and always take proper safety precautions when operating a power washer.

Problem	Solution
Dirt or debris	Clean the decking to remove dirt or debris by using soap, hot water and a stiff bristle.
Mold & Mildew	Use conventional wood washes or cleaners that contain bleach and detergent (refer to Mold Technical Bulletin).
Chalk Markings	All colored chalk lines are permanent except white. Scrubbing the area with hot soapy water with bleach may dislodge some of the chalk
Ice, Snow	Calcium chloride or rock salt, available in many home centers, will melt ice on decking. Rinse off when first practical.
Water Spots	Clean with a deck cleaner containing Oxalic Acid. It is always best to test the cleaner on an inconspicuous or scrap piece of deck to make sure the cleaner does not harm the deck surface.
Oil and Grease Stains	Scrub in a household-degreasing agent as soon as the stain occurs. Rinse with hot water.
Berries and Wine Stains	Mix bleach into hot water according to the bleach-packaging label. Scrub the stain lightly and rinse thoroughly. The stain may not disappear entirely.
Ink Stains	Inks may be permanent. However, scrubbing with hot soapy water may lighten the stain. Rinse thoroughly.
Small scratches by high heel shoes, hard tools	On terrace surfaces can occur due to condensation of water and the accumulation of damp dirt or dust particles with subsequent drying to so-called water spots. Amplified this effect is partially under covered areas. Clean it contains a cleaning agent that oxalic acid. It is recommended that the cleaner on an inconspicuous area to apply to check in advance whether the cleaner does not damage the surface.

Note: Please only walk with shoes on the floor after long sunshine, as the wpc board could be very hot.

Huangshan Huasu New Material Science & Technology Co., Ltd

Sales office & Manufacturing

Add: Chengbei Industrial Zone, Huizhou, Huangshan, Anhui, 245900

Tel: +86-559-3582638 Fax: +86-559-3581884

Email: info@huasuwpc.com

Web: www.huasuwpc.com www.ecotech-wpc.com