

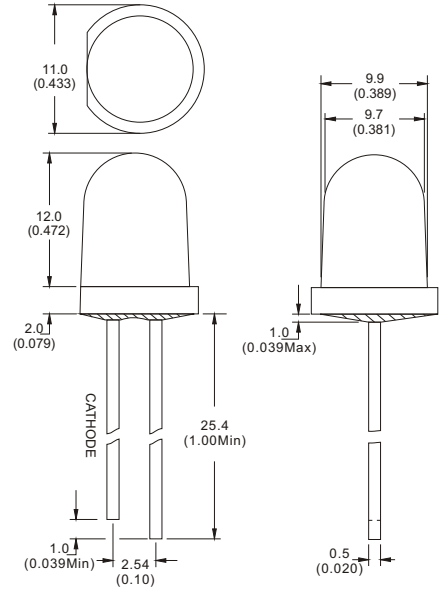

● Features:

- 1. Chip material: AlGaInP/GaAs
- 2. Emitting color: Ultra Orange
- 3. Lens Appearance: Water Clear
- 4. Long life-solid state reliability
- 5. IC compatible/Low current capability
- 6. RoHS compliant

● Package dimensions



Notes:

- 1. All dimensions are in millimeters (inches).
- 2. Tolerance is $\pm 0.25\text{mm}$ ($0.01''$) unless otherwise specified.
- 3. An epoxy meniscus may extend about 1.0mm down to the lead.
- 4. Specifications are subject to change without notice.

● Absolute maximum ratings ($T_a = 25^\circ\text{C}$)

Characteristic	Test Condition	Symbol	UE	Units
Pulse Forward Current	1/10 duty cycle 0.1ms Pulse width	I_{FP}	80	mA
DC Forward Current		I_F	25	mA
Reverse Current	$V_R = 5V$	I_R	10	μA
Power Dissipation		P_D	65	mW
Operating Temperature		T_{OPR}	-40 to +80	$^\circ\text{C}$
Storage Temperature		T_{STG}	-40 to +85	$^\circ\text{C}$
Lead Soldering Temperature	1.60mm from body maximum 3 seconds	T_{SOL}	260	$^\circ\text{C}$



● Electrical And Optical Characteristics(Ta=25°C)

Parameter	Test Condition	Symbol	Min.	Typ.	Max.	Units
Forward Voltage	IF=20mA	V _F	---	2.00	---	V
Reverse Current	V _R =5V	I _R	---	---	10	μA
Peak Wavelength	IF=20mA	λ _p	627	632	637	nm
Dominant Wavelength	IF=20mA	λ _D	619	624	629	nm
Spectral Line Half-width	IF=20mA	Δλ	---	20	---	nm
Luminous Intensity	IF=20mA	I _v	---	6000	---	mcd
Viewing Angle	IF=20mA	2θ½	12	15	18	deg.

● Typical electro-optical characteristics curves

