

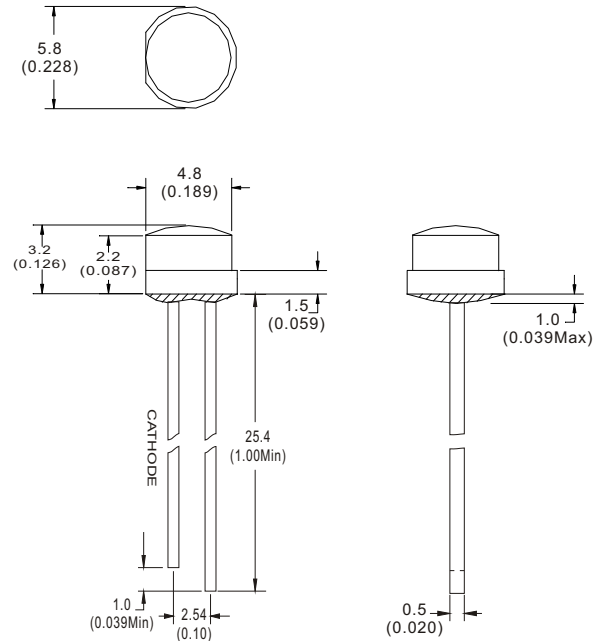

### ● Features:

- 1. Chip material: InGaN
- 2. Emitting color: Pure Green
- 3. Lens Appearance: Water Clear
- 4. Long life-solid state reliability
- 5. IC compatible/Low current capability
- 6. RoHS compliant

### ● Package dimensions



### Notes:

- 1. All dimensions are in millimeters (inches).
- 2. Tolerance is  $\pm 0.25\text{mm}$  ( $0.01''$ ) unless otherwise specified.
- 3. An epoxy meniscus may extend about 1.0mm down to the lead.
- 4. Specifications are subject to change without notice.

### ● Absolute maximum ratings ( $T_a = 25^\circ\text{C}$ )

Characteristic	Test Condition	Symbol	PG	Units
Pulse Forward Current	1/10 duty cycle 0.1ms Pulse width	$I_{FP}$	100	mA
DC Forward Current		$I_F$	30	mA
Reverse Current	$V_R = 5V$	$I_R$	10	$\mu A$
Power Dissipation		$P_D$	120	mW
Operating Temperature		$T_{OPR}$	-40 to +80	$^\circ\text{C}$
Storage Temperature		$T_{STG}$	-40 to +85	$^\circ\text{C}$
Lead Soldering Temperature	1.60mm from body maximum 3 seconds	$T_{SOL}$	260	$^\circ\text{C}$



### ● Electrical And Optical Characteristics(Ta=25°C)

Parameter	Test Condition	Symbol	Min.	Typ.	Max.	Units
Forward Voltage	IF=20mA	V <sub>F</sub>	---	3.30	4.00	V
Reverse Current	V <sub>R</sub> =5V	I <sub>R</sub>	---	---	10	μA
Peak Wavelength	IF=20mA	λ <sub>p</sub>	---	---	---	nm
Dominant Wavelength	IF=20mA	λ <sub>D</sub>	515	520	525	nm
Spectral Line Half-width	IF=20mA	Δλ	---	35	---	nm
Luminous Intensity	IF=20mA	I <sub>v</sub>	---	2700	---	mcd
Viewing Angle	IF=20mA	2θ½	---	46	---	deg.

### ● Typical electro-optical characteristics curves

RELATIVE INTENSITY VS WAVELENGTH

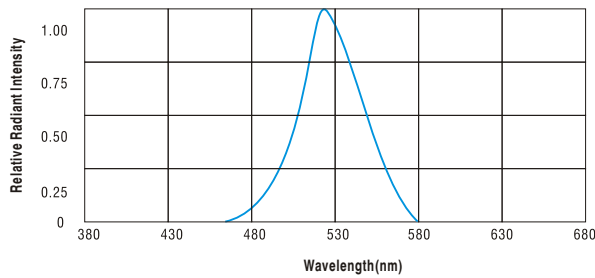

FORWARD CURRENT VS FORWARD VOLTAGE

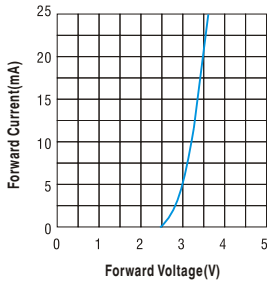

LUMINOUS INTENSITY VS FORWARD CURRENT

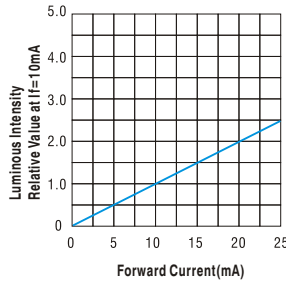

PEAK FORWARD VOLTAGE VS FORWARD CURRENT (100μS TEST PULSE, 1% DUTY CYCLE)

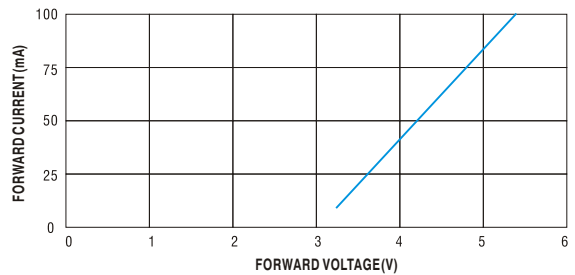

FORWARD CURRENT DERATING CURVE

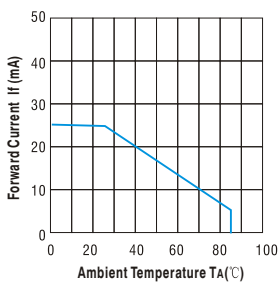

LUMINOUS INTENSITY VS AMBIENT TEMPERATURE

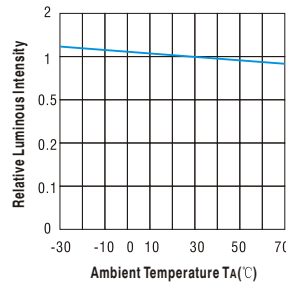

DOMINANT WAVELENGTH VS. FORWARD CURRENT

