

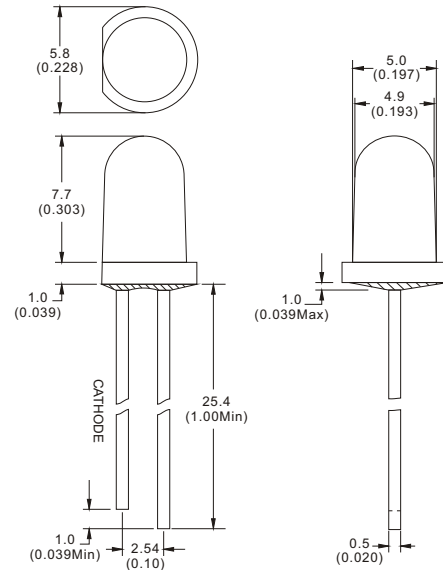

● Features:

- 1. Chip material: AlGaInP/GaAs
- 2. Emitting color: Ultra Orange
- 3. Lens Appearance: Red diffused
- 4. Long life-solid state reliability
- 5. IC compatible/Low current capability
- 6. RoHS compliant

● Package dimensions



Notes:

- 1. All dimensions are in millimeters (inches).
- 2. Tolerance is $\pm 0.25\text{mm}$ (0.01") unless otherwise specified.
- 3. An epoxy meniscus may extend about 1.0mm down to the lead.
- 4. Specifications are subject to change without notice.

● Absolute maximum ratings ($T_a = 25^\circ\text{C}$)

| Characteristic | Test Condition | Symbol | UE | Units |
|----------------------------|------------------------------------|-----------|------------|------------------|
| Pulse Forward Current | 1/10 duty cycle 0.1ms Pulse width | I_{FP} | 80 | mA |
| DC Forward Current | | I_F | 30 | mA |
| Reverse Current | $V_R = 5V$ | I_R | 10 | μA |
| Power Dissipation | | P_D | 65 | mW |
| Operating Temperature | | T_{OPR} | -40 to +80 | $^\circ\text{C}$ |
| Storage Temperature | | T_{STG} | -40 to +85 | $^\circ\text{C}$ |
| Lead Soldering Temperature | 1.60mm from body maximum 3 seconds | T_{SOL} | 260 | $^\circ\text{C}$ |



● Electrical And Optical Characteristics(Ta=25°C)

| Parameter | Test Condition | Symbol | Min. | Typ. | Max. | Units |
|--------------------------|--------------------|----------------|------|------|------|-------|
| Forward Voltage | IF=20mA | V _F | --- | 2.00 | --- | V |
| Reverse Current | V _R =5V | I _R | --- | --- | 10 | μA |
| Peak Wavelength | IF=20mA | λ _p | 627 | 632 | 637 | nm |
| Dominant Wavelength | IF=20mA | λ _D | 619 | 624 | 629 | nm |
| Spectral Line Half-width | IF=20mA | Δλ | --- | 20 | --- | nm |
| Luminous Intensity | IF=20mA | I _v | --- | 1800 | --- | mcd |
| Viewing Angle | IF=20mA | 2θ½ | 35 | 40 | 45 | deg. |

● Typical electro-optical characteristics curves

