

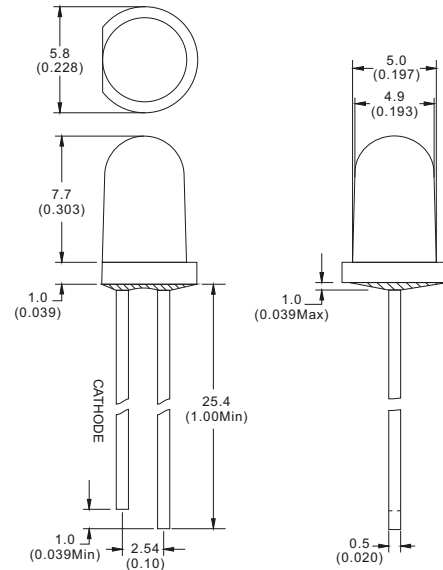

● Features:

- 1. Chip material: InGaN
- 2. Emitting color: Pure Green
- 3. Lens Appearance: Water Clear
- 4. Long life-solid state reliability
- 5. IC compatible/Low current capability
- 6. RoHS compliant

● Package dimensions



Notes:

- 1. All dimensions are in millimeters (inches).
- 2. Tolerance is $\pm 0.25\text{mm}$ ($0.01''$) unless otherwise specified.
- 3. An epoxy meniscus may extend about 1.0mm down to the lead.
- 4. Specifications are subject to change without notice.

● Absolute maximum ratings ($T_a=25^\circ\text{C}$)

Characteristic	Test Condition	Symbol	PG	Units
Pulse Forward Current	1/10 duty cycle 0.1ms Pulse width	I_{FP}	100	mA
DC Forward Current		I_F	30	mA
Reverse Current	$V_R=5V$	I_R	10	μA
Power Dissipation		P_D	120	mW
Operating Temperature		T_{OPR}	-40 to +80	$^\circ\text{C}$
Storage Temperature		T_{STG}	-40 to +85	$^\circ\text{C}$
Lead Soldering Temperature	1.60mm from body maximum 3 seconds	T_{SOL}	260	$^\circ\text{C}$



● Electrical And Optical Characteristics(Ta=25°C)

Parameter	Test Condition	Symbol	Min.	Typ.	Max.	Units
Forward Voltage	IF=20mA	V _F	---	3.30	3.80	V
Reverse Current	V _R =5V	I _R	---	---	10	μA
Peak Wavelength	IF=20mA	λ _p	---	---	---	nm
Dominant Wavelength	IF=20mA	λ _D	515	520	525	nm
Spectral Line Half-width	IF=20mA	Δλ	---	35	---	nm
Luminous Intensity	IF=20mA	I _v	---	15000	---	mcd
Viewing Angle	IF=20mA	2θ½	15	20	25	deg.

● Typical electro-optical characteristics curves

RELATIVE INTENSITY VS WAVELENGTH

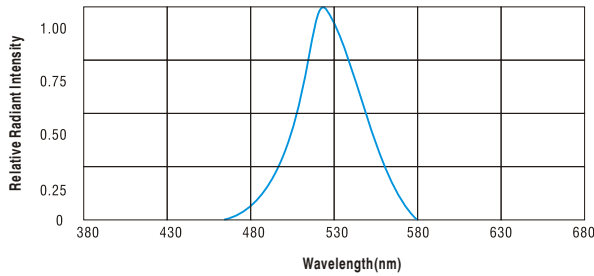

FORWARD CURRENT VS FORWARD VOLTAGE

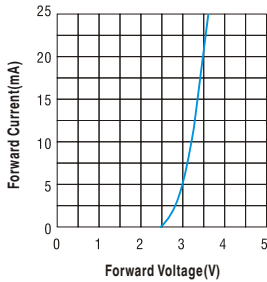

LUMINOUS INTENSITY VS FORWARD CURRENT

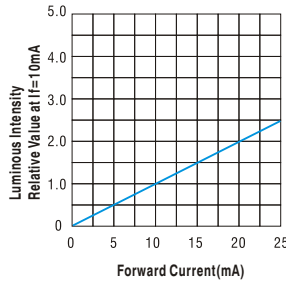

PEAK FORWARD VOLTAGE VS FORWARD CURRENT (100μS TEST PULSE, 1% DUTY CYCLE)

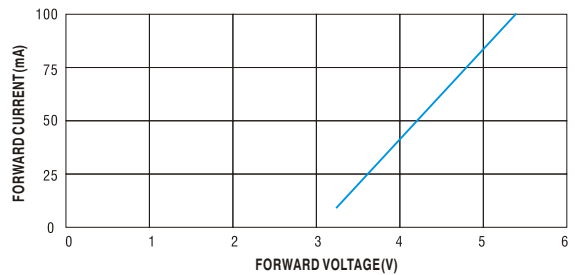

FORWARD CURRENT DERATING CURVE

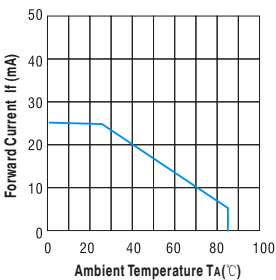

LUMINOUS INTENSITY VS AMBIENT TEMPERATURE

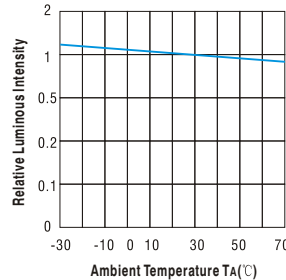

DOMINANT WAVELENGTH VS. FORWARD CURRENT

