



0.36"(9.10mm)Three Digit 7 Segment Display

Features:

- *High segment intensity
- *Wide viewing angle
- *Range of colors
- *Black face White segment
- *RoHS compliant

Available option:

- *Alternative face and segment color
- *Alternative font
- *Cropped terminal pins
- *Available emitting color
- *Low current version

Electro/Optical Characteristics If=20mA Ta=25°C

Part Number Common Cathode	Part Number Common Anode	Emitting Color	Peak Wavelength	Forward Voltage V _F /Seg.		Luminous Intensity I _v /seg.	
				Typ.	Max.	Min.	Typ.
NFD-3631AH-11	NFD-3631BH-11	GaP/GaP Red	700	2.25	2.50	0.40	0.80
NFD-3631AS-11	NFD-3631BS-11	GaAlAs/GaAs SH Hi-Red	660	1.80	2.20	8.00	12.00
NFD-3631AD-11	NFD-3631BD-11	GaAlAs/GaAs DH Super Red	660	1.80	2.50	22.00	28.00
NFD-3631AE-11	NFD-3631BE-11	GaAsP/GaP Orange	632	2.10	2.50	8.00	12.00
NFD-3631AY-11	NFD-3631BY-11	GaAsP/GaP Yellow	585	2.10	2.50	4.00	7.00
NFD-3631AG-11	NFD-3631BG-11	GaP/GaP Green	570	2.20	2.50	7.00	11.00
Units			nm	V		mcd	

Maximum Ratings Ta=25°C (Derate above 25°C)

Characteristic	Test Condition	Symbol	H	S	D	E	Y	G	Units
Pulse Forward Current Per Seg.	1/10 duty cycle 0.1ms Pulse width	I _{FP}	50	100	100	100	100	100	mA
DC Forward Current Per Seg.		I _F	15	25	25	30	30	30	mA
Reverse Current Per Seg.	V _R =5V	I _R	10	10	10	10	10	10	μA
Power Dissipation		P _D	40*24	60*24	60*24	80*24	80*24	80*24	mW
Operating Temperature		T _{OPR}	-40 to +80						°C
Storage Temperature		T _{TSG}	-40 to +85						°C
Lead soldering temperature	1.60mm from body maximum 3 seconds		260						°C

Checked

Chen N.H.

Approved

Jason Chen

Date

Nov/20/2006

PAGE 1 / 2



0.36"(9.10mm)Three Digit 7 Segment Display

PACKAGE DIMENSION

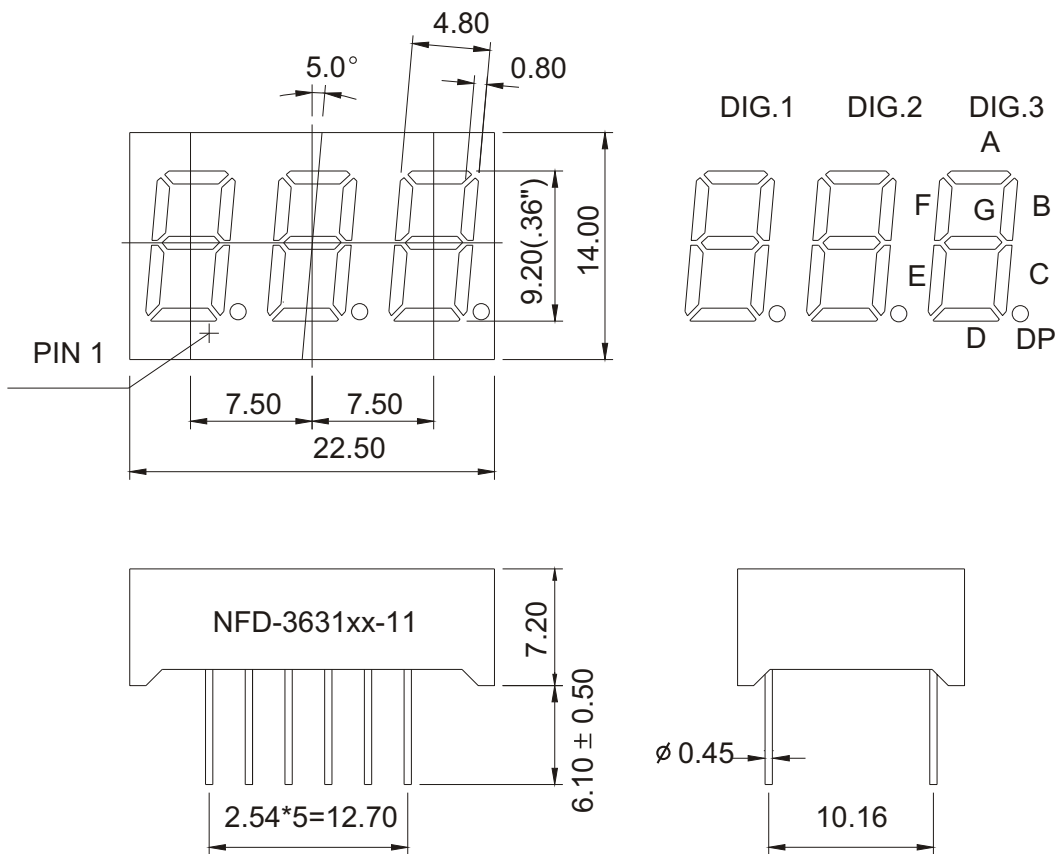

INTERNAL CIRCUIT DIAGRAM

Common Cathode NFD-3631Ax

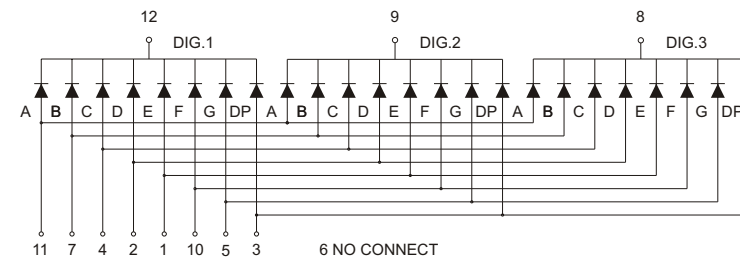

Common Anode NFD-3631Bx

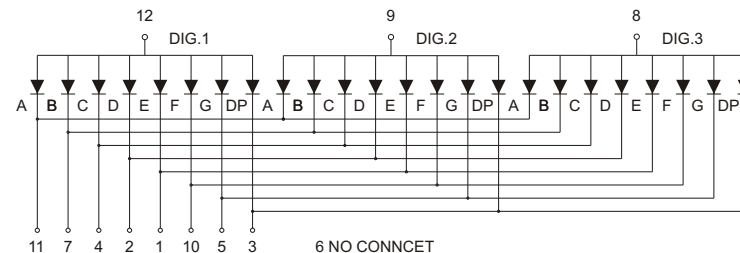

Tolerance $\pm 0.25\text{mm}$ unless stated

Checked

Chen N.H.

Approved

Jason Chen

Date

Nov/20/2006

PAGE 2 /2