

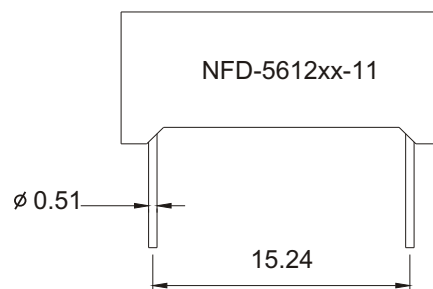

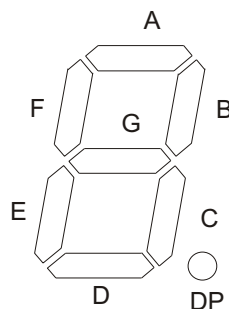

# 0.56"(14.20mm)Single Digit 7 Segment Display

## PACKAGE DIMENSION

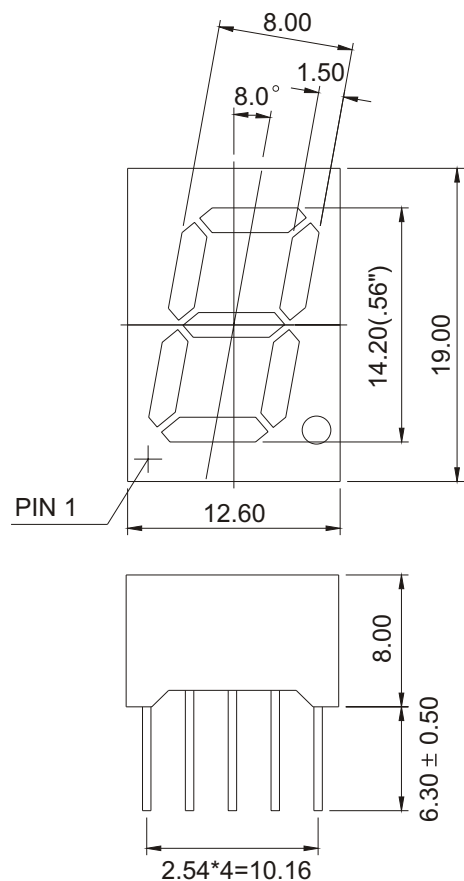

Tolerance  $\pm 0.25\text{mm}$  unless stated

## INTERNAL CIRCUIT DIAGRAM

### Common Cathode NFD-5612Ax

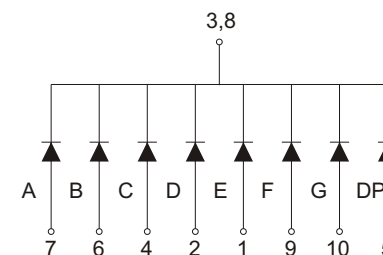

### Common Anode NFD-5612Bx

