



0.56"(14.2mm)Single Digit 7 Segment Display

Features:

- *Ultra segment intensity
- *Wide viewing angle
- *Range of colors
- *Gray face White segment
- *RoHS compliant

Available option:

- *Alternative face and segment color
- *Alternative font
- *Cropped terminal pins
- *Available emitting color
- *Low current version

Electro/Optical Characteristics If=20mA Ta=25°C

Part Number Common Cathode	Part Number Common Anode	Emitting Color	Peak Wavelength	Forward Voltage Vf/Seg.		Luminous Intensity Iv/Seg.	
				Typ.	Max.	Min.	Typ.
NFD-5611AUHR-21	NFD-5611BUHR-21	AlGaInP/GaAs Ultra Red	640	2.00	2.50	40.00	60.00
NFD-5611AUE-21	NFD-5611BUE-21	AlGaInP/GaAs Ultra Orange	632	2.00	2.50	40.00	60.00
NFD-5611AYO-21	NFD-5611BYO-21	AlGaInP/GaAs Ultra Amber	605	2.00	2.50	40.00	60.00
NFD-5611AUY-21	NFD-5611BUY-21	AlGaInP/GaAs Ultra Yellow	590	2.00	2.50	40.00	60.00
NFD-5611AUG-21	NFD-5611BUG-21	AlGaInP/GaAs Ultra Green	574	2.10	2.50	25.00	40.00
NFD-5611APG-21	NFD-5611BPG-21	InGaN/SiC Pure Green	525	3.30	3.80	150.00	200.00
NFD-5611AUB-21	NFD-5611BUB-21	InGaN/SiC Ultra Blue	470	3.30	3.80	40.00	100.00
NFD-5611AUW-21	NFD-5611BUW-21	InGaN/SiC Ultra White	X-0.31/Y-0.31	3.30	3.80	200.00	500.00
Units			nm	V		mcd	

Maximum Ratings Ta=25°C (Derate above 25°C)

Characteristic	Test Condition	Symbol	UHR	UE	YO	UY	UG	PG	UB	UW	Units
Pulse Forward Current Per Seg.	1/10 duty cycle 0.1ms Pulse width	I _{FP}	100	100	100	100	100	100	100	100	mA
DC Forward Current Per Seg.		I _F	30	30	30	30	30	30	30	30	mA
Reverse Current Per Seg.	V _R =5V	I _R	10	10	10	10	10	10	10	10	μA
Power Dissipation		P _D	65*8	65*8	65*8	65*8	75*8	110*8	120*8	120*8	mW
Operating Temperature		T _{OPR}	-40 to +80								°C
Storage Temperature		T _{TSG}	-40 to +85								°C
Lead soldering temperature	1.60mm from body maximum 3 seconds		260								°C

Checked

Chen N.H.

Approved

Jason Chen

Date

Mar/04/2007

PAGE 1 / 2



0.56"(14.20mm)Single Digit 7 Segment Display

PACKAGE DIMENSION

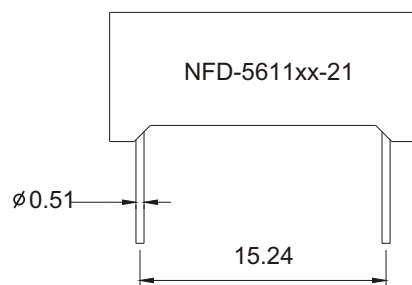
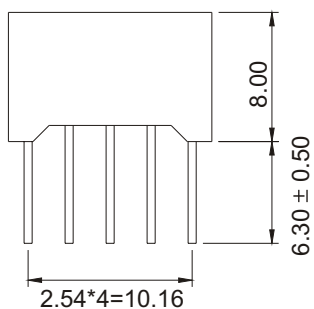
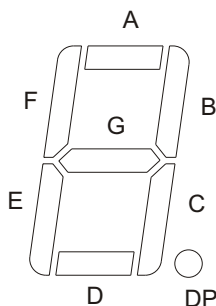
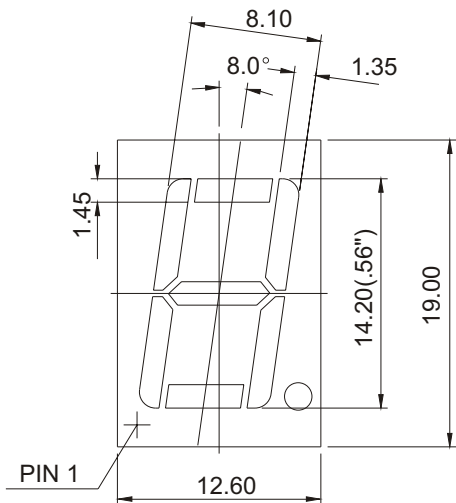

Tolerance $\pm 0.25\text{mm}$ unless stated

INTERNAL CIRCUIT DIAGRAM

Common Cathode NFD-5611Ax

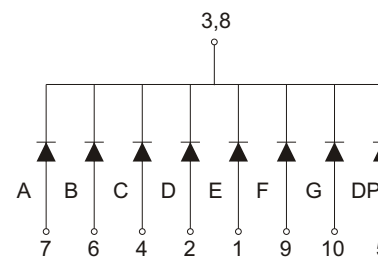

Common Anode NFD-5611Bx

